

Operator's manual
HUSQVARNA AUTOMOWER®
430XH/450XH



EN, English

Read the operator's manual carefully and make sure that you understand the instructions before you use the product.

Contents

1 Introduction		6 Troubleshooting	
1.1 Support.....	3	6.1 Introduction - troubleshooting.....	40
1.2 Product description.....	3	6.2 Fault messages.....	40
1.3 Product overview.....	4	6.3 Information messages.....	45
1.4 Symbols on the product.....	5	6.4 LED indicator lamp on the charging station.....	47
1.5 Symbols on the display.....	5	6.5 LED indicator lamp on the product.....	48
1.6 Symbols on the battery.....	6	6.6 Symptoms.....	49
1.7 Menu structure overview 1.....	7	6.7 Finding breaks in the loop wire.....	50
1.8 Menu structure overview 2.....	8	7 Transportation, storage and disposal	
1.9 Menu structure overview 3.....	9	7.1 Transportation.....	53
1.10 Display.....	10	7.2 Storage.....	53
1.11 Keypad.....	10	7.3 Disposal.....	53
2 Safety		8 Technical data	
2.1 Safety definitions.....	11	8.1 Technical data.....	54
2.2 General safety instructions.....	11	9 Warranty	
2.3 Safety instructions for operation.....	13	9.1 Warranty terms.....	57
3 Installation		10 Applicable to US/CA market	
3.1 Introduction - Installation.....	16	10.1 Supplier's Declaration of Conformity.....	58
3.2 Before the installation of the wires.....	16	10.2 Compliance requirements.....	58
3.3 Before the installation of the product.....	16		
3.4 Installation of the product.....	20		
3.5 To put the wire into position with stakes...	22		
3.6 To bury the boundary wire or the guide wire.....	22		
3.7 To extend the boundary wire or the guide wire.....	22		
3.8 After the installation of the product.....	22		
3.9 Automower® Connect app.....	23		
3.10 To do the product settings.....	24		
4 Operation			
4.1 Main switch.....	34		
4.2 To start the product.....	34		
4.3 Operating mode - Start.....	34		
4.4 Operating mode - Park.....	35		
4.5 To stop the product.....	35		
4.6 To switch off the product.....	35		
4.7 To charge the battery.....	35		
5 Maintenance			
5.1 Introduction - maintenance.....	37		
5.2 Clean the product.....	37		
5.3 Replace the blades.....	38		
5.4 Battery.....	38		
5.5 Winter service.....	39		

1 Introduction

Serial number:

PIN code:

The serial number is on the product rating plate and on the product carton.

- Use the serial number to register your product on www.husqvarna.com.

1.1 Support

For support about the Husqvarna product, speak to your servicing dealer.

The operator selects the operation settings with the keys on the keypad. The display shows the selected and possible operation settings, and the operating mode of the product.

1.2 Product description

Note: Husqvarna regularly updates the appearance and function of the products. Refer to *Support on page 3*.

The boundary wire and the guide wire controls the movement of the product within the work area.

1.2.1 Automower® Connect

Automower® Connect is a mobile application that makes it possible to select the operation settings remotely. Refer to *Automower® Connect app on page 23*.

The product is a robotic lawn mower. The product has a battery power source and cuts the grass automatically. Collection of grass is not necessary.

1.3 Product overview

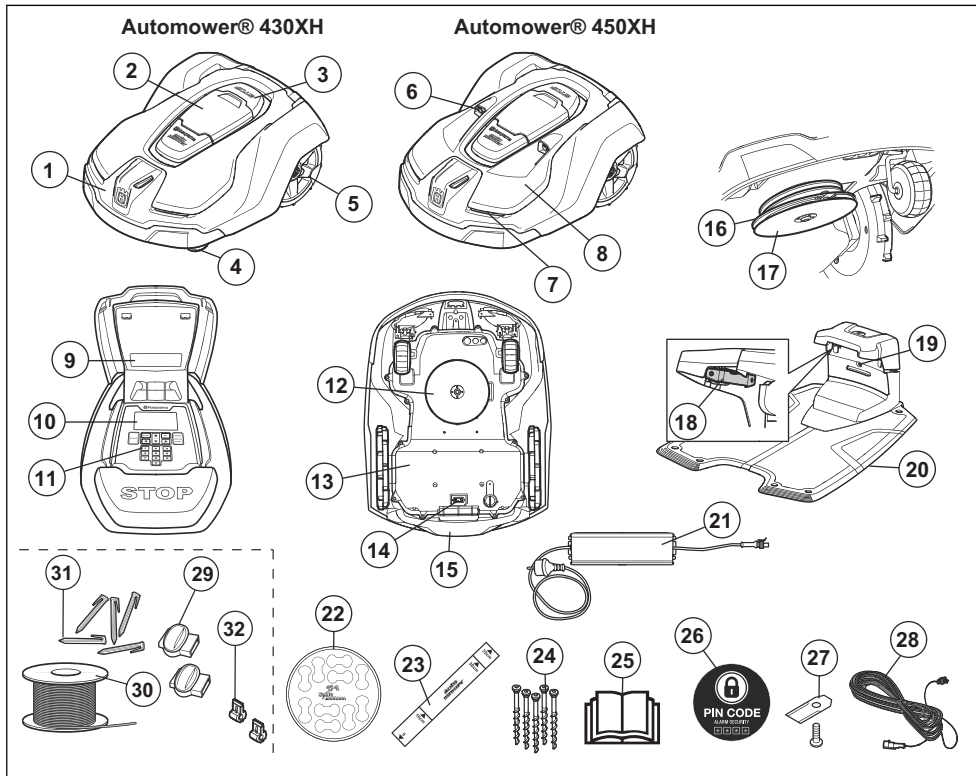

The numbers in the figure represent:

- | | |
|--|--|
| 1. Body | 15. Handle |
| 2. Hatch to display and keypad | 16. Blade disc |
| 3. Stop button | 17. Skid plate |
| 4. Front wheels | 18. Contact plates |
| 5. Rear wheels | 19. LED for operation check of the charging station and boundary wire |
| 6. Ultrasonic sensors | 20. Charging station |
| 7. Headlights | 21. Power supply |
| 8. Replaceable cover | 22. Cable markers |
| 9. Rating plate (incl. product identification code) | 23. Measurement gauge when installing the boundary wire (the measurement gauge is broken loose from the box) |
| 10. Display | 24. Screws for securing the charging station |
| 11. Keypad | 25. Operator's Manual and Quick Guide |
| 12. Cutting system | 26. Alarm decal |
| 13. Chassis box with electronics, battery and motors | 27. Extra blades |
| 14. Main switch | 28. Low voltage cable |

- 29. Couplers for the loop wire ¹
- 30. Loop wire for boundary loop and guide wire ₂
- 31. Stakes ³
- 32. Connectors for the loop wire ⁴

1.4 Symbols on the product

These symbols can be found on the product. Study them carefully.



WARNING: Read the user instructions before operating the product.



WARNING: Operate the disabling device before working on or lifting the machine.

The product can only start when the correct PIN code has been entered. Switch off the product before carrying out any inspections and/or maintenance.



WARNING: Keep a safe distance from the machine when operating. Keep your hands and feet away from the rotating blades.



WARNING: Do not ride on the machine. Never put your hands or feet close to or under the machine.

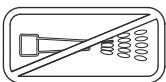

Never use a high-pressure washer or even running water to clean the product.

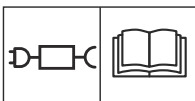

Use a detachable power supply as defined on the rating label next to the symbol.

 This product conforms to the applicable EC Directives.



Noise emission to surroundings. The product's emissions are set out in *Technical data on page 54* and on the rating plate.



It is not permitted to dispose this product as normal household waste. Ensure that the product is recycled in accordance with local legal requirements.



The chassis contains components which are sensitive to electrostatic discharge (ESD). The chassis must also be resealed in a professional manner. For these reasons the chassis shall only be opened by authorized service technicians. A broken seal can result in the entire or parts of the guarantee no longer being valid.



The low voltage cable must not be shortened, extended or spliced. Do not use a trimmer nearby the low voltage cable. Be careful when trimming edges where the cables are placed.

1.5 Symbols on the display



The timer function controls when the product cuts the lawn.



The cutting height function sets the cutting height of the product.



The security function lets the operator select between 3 security levels.

¹ Is a part of the Installation kit which is purchased separately.

² See note 1

³ See note 1

⁴ See note 1



The messages function shows error messages and possible cause for the problems.



The weather timer function automatically adapts the cutting intervals to the grass growth.



The installation function for manual settings for the installation.



The settings function is where the general settings for the products are set.



The accessories function is used for settings made for the accessories.



The product will not cut the grass do to the timer function.



The product overrides the timer function.



The battery indicator shows the charge level of the battery. When the product charges the symbol flashes.



The product is put in the charging station but do not charge the battery.



The product is set in ECO-mode.



The GPS-supported navigation is active. Flashes as it collects GPS information.



The GPS-supported navigation is not active.



The bars show the signal strength of the GPRS reception. (Automower® Connect)



An X next to the bars indicates a problem with the connection to the Internet server. (Automower® Connect)



The SIM symbol indicates that there is a problem with the SIM card or the module. (Automower® Connect)

1.6 Symbols on the battery



Read the user instructions.



Do not discard the battery into fire and do not expose the battery to a heat source.



Do not immerse the battery into water.

1.7 Menu structure overview 1

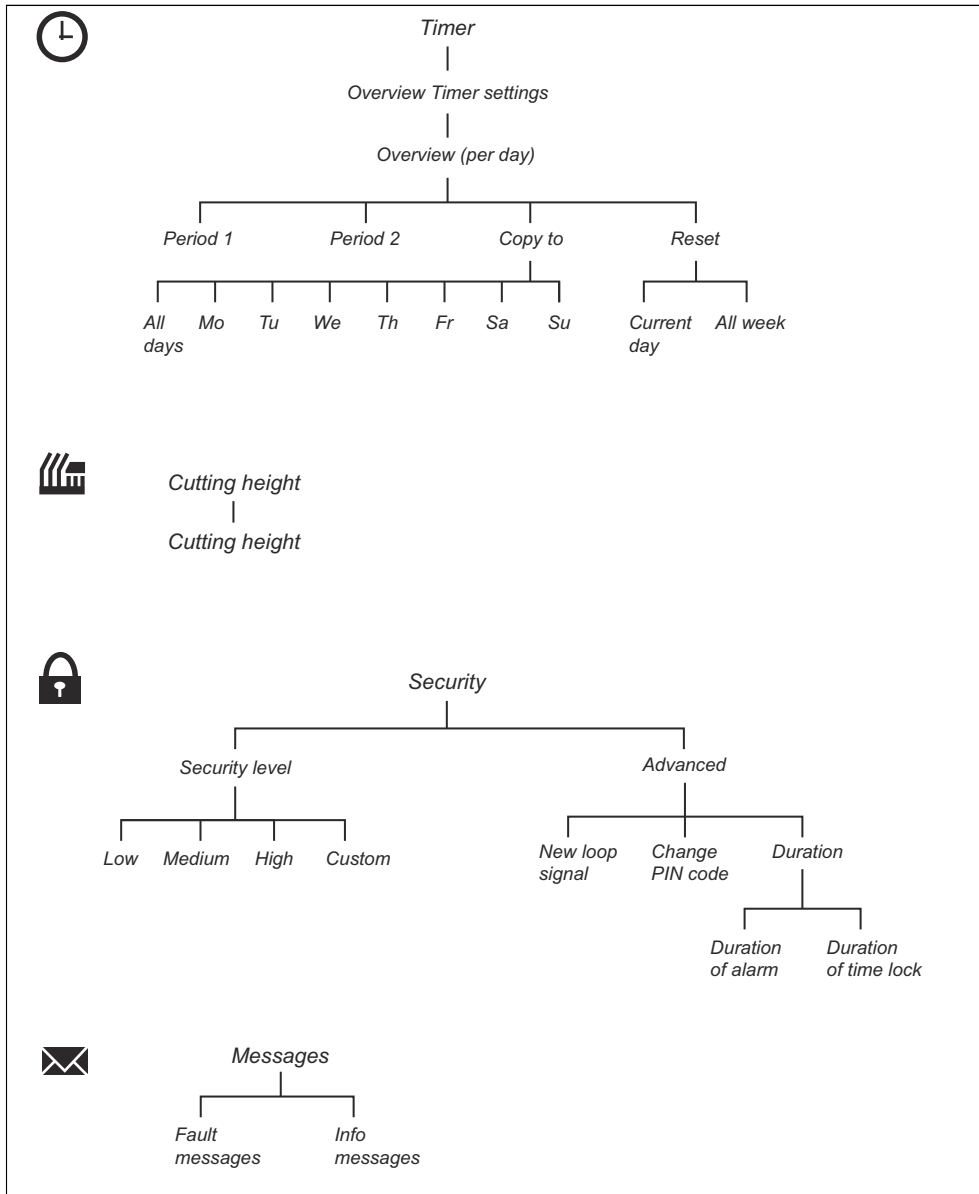

1.8 Menu structure overview 2

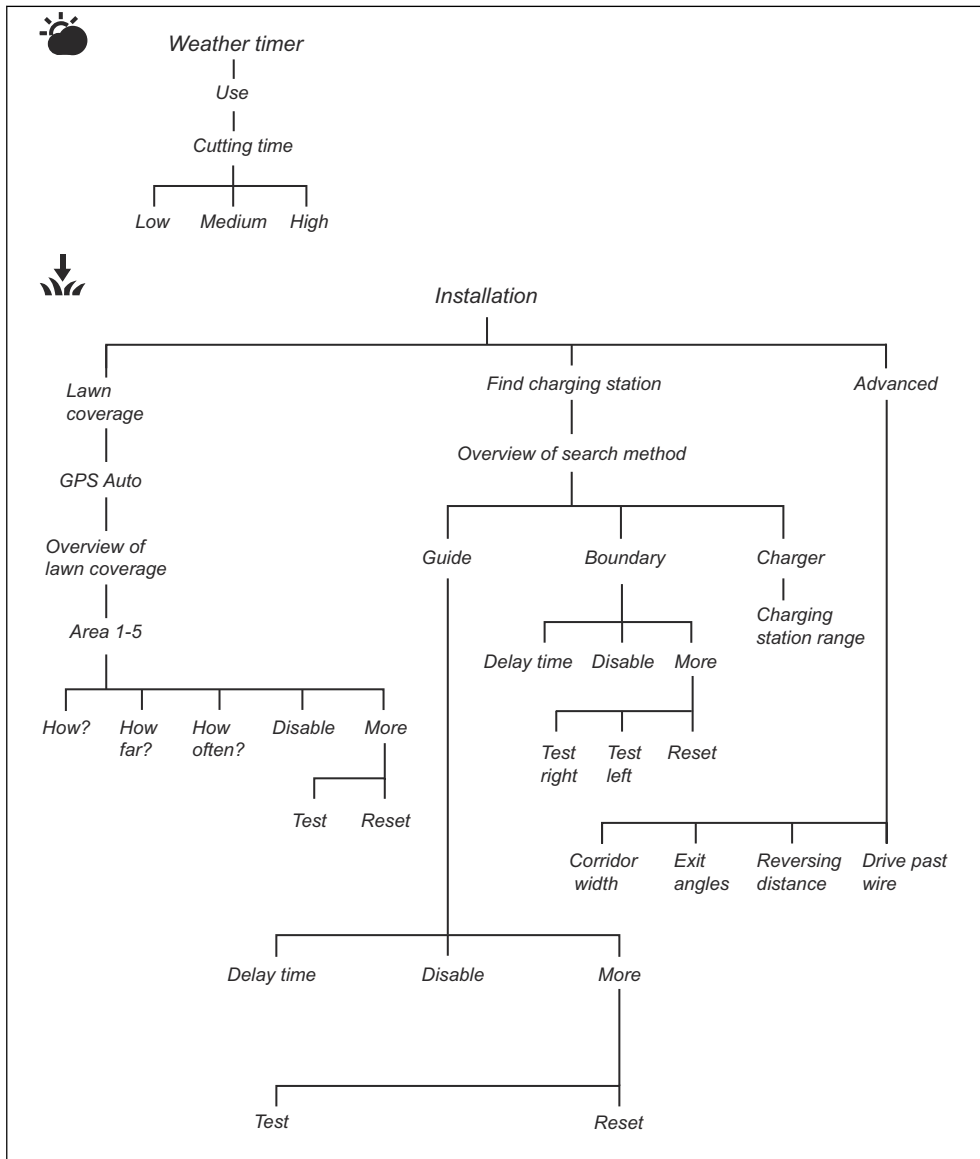

1.9 Menu structure overview 3

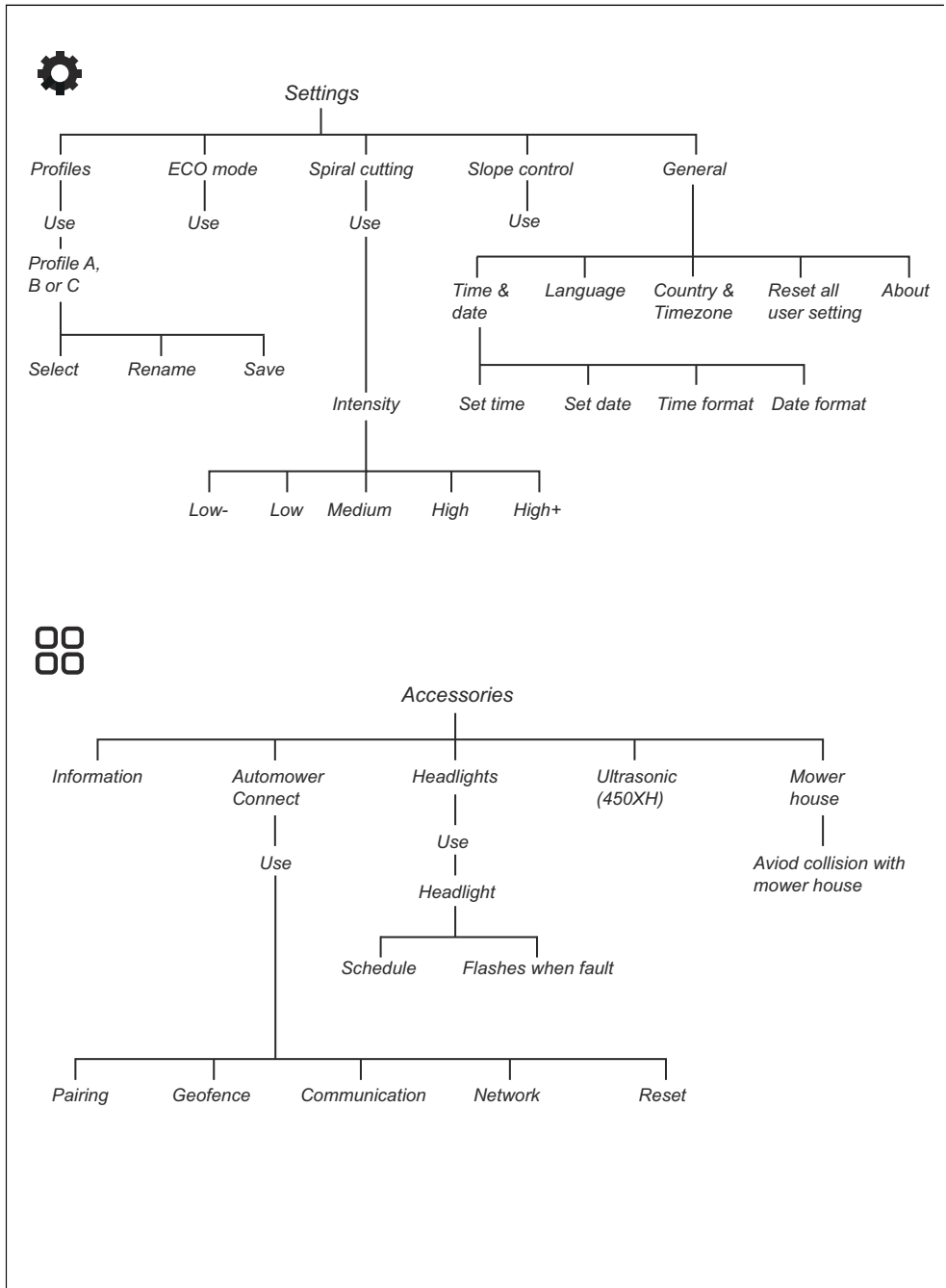

1.10 Display

The display on the product shows information and settings of the product.

To access the display, push the **STOP** button.

1.11 Keypad

The keypad on the product let the operator navigate in the menu of the product. To access the keypad, push the **STOP** button.

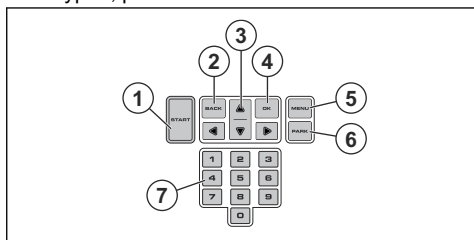

1. The **START** button is used to start the operation of the product.
2. The **BACK** button is used when moving back up in the menu lists.
3. The **arrow** buttons are used to navigate in the menu.
4. The **OK** button is used to confirm the chosen settings in the menus.
5. The **MENU** button is used to go to the main menu.
6. The **PARK** button sends the product to the charging station.
7. The **number** buttons are used to enter digits, for example, PIN code, time and date.

2 Safety

2.1 Safety definitions

Warnings, cautions and notes are used to point out specially important parts of the manual.



WARNING: Used if there is a risk of injury or death for the operator or bystanders if the instructions in the manual are not obeyed.



CAUTION: Used if there is a risk of damage to the product, other materials or the adjacent area if the instructions in the manual are not obeyed.

Note: Used to give more information that is necessary in a given situation.

2.2 General safety instructions

The following system is used in the Operator's Manual to make it easier to use:

- Text written in *italics* is a text that is shown on the display of the product or is a reference to another section in the Operator's Manual.
- Text written in **bold** is one of the buttons on the product.
- Text written in *UPPERCASE* and *italics* refer to the different operating modes available in the product.

2.2.1 IMPORTANT. READ CAREFULLY BEFORE USE. KEEP FOR FUTURE REFERENCE

The operator is responsible for accidents or hazards occurring to other people or property.

This appliance is not intended for use by persons (including children) with reduced physical, sensory or mental capabilities (that could affect a safe handling of the product), or lack of experience and knowledge, unless they have been given supervision or instruction concerning use of the appliance by a person responsible for their safety.

This appliance can be used by children aged from 8 years and above and persons with reduced physical, sensory or mental capabilities or lack of experience and knowledge if they have been given supervision or instruction concerning use of the appliance in a safe way and understand the hazards involved. Local regulations may restrict the age of the operator. Cleaning and maintenance shall not be made by children without supervision.

Never connect the power supply to an outlet if the plug or cord is damaged. Worn or damaged cord increase the risk of electric shock.

Only charge the battery in the included charging station. Incorrect use may result in electric shock, overheating or leaking of corrosive liquid from the battery. In the event of leakage of electrolyte, flush with water/neutralizing agent. Seek medical help if it comes in contact with the eyes.

Use only original batteries recommended by the manufacturer. Product safety cannot be guaranteed with other than original batteries. Do not use non-rechargeable batteries.

The appliance must be disconnected from the supply mains when removing the battery.



WARNING: The product can be dangerous if used incorrectly.



WARNING: Do not use the product when persons, especially children, or animals, are in the work area.



WARNING: Keep your hands and feet away from the rotating blades. Never put your hands or feet close to or under the product when the motor is running.

2.3 Safety instructions for operation

2.3.1 Use

- The product may only be used with the equipment recommended by the manufacturer. All other types of use are incorrect. The manufacturer's instructions with regard to operation/maintenance must be followed precisely.
- Warning signs shall be placed around the work area of the product if it is used in public areas. The signs shall have the following text: **Warning! Automatic lawnmower! Keep away from the machine! Supervise children!**

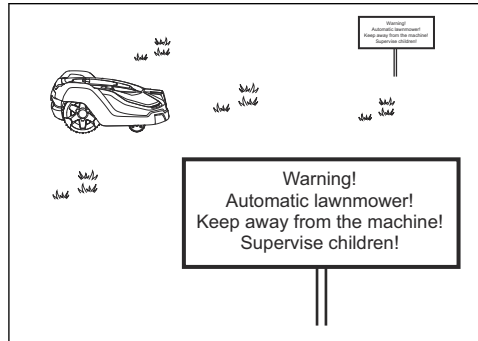

- Use the **PARK** function or switch off the main switch when persons, especially children or animals, are in the work area. It is recommended to program the product for use during hours when the area is free from activity, e.g. at night. Refer to *Park until further notice on page 35*. Consider that certain species, e.g. hedgehogs, are active at night. They can potentially be harmed by the product.
- The product may only be operated, maintained and repaired by persons that are fully conversant with its special characteristics and safety regulations. Please read the Operator's Manual carefully and make sure you understand the instructions before using the product.
- It is not permitted to modify the original design of the product. All modifications are made at your own risk.
- Check that there are no stones, branches, tools, toys or other objects on the lawn that can damage the blades. Objects on the lawn can also lead to the product getting stuck. Help may be required to remove the object before the product can continue mowing. Always set the main switch in position *0* before clearing a blockage.

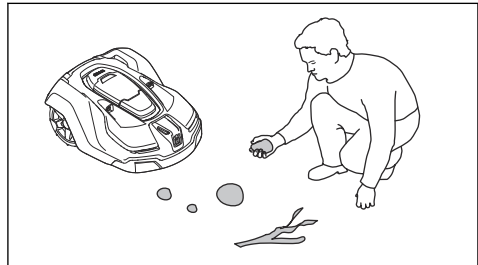

- Start the product according to the instructions. When the main switch is set to 1; make sure to keep your hands and feet away from the rotating blades. Never put your hands and feet under the product.
- Never touch moving hazardous parts, such as the blade disc, before it has come to a complete stop.
- Never lift up the product or carry it around when the main switch is in position 1.
- The product must never be allowed to collide with persons or other living creatures. If a person or other living creature comes in the way of the product, it shall be stopped immediately. Refer to *To stop the product on page 35*.
- Do not put anything on top of the product or its charging station.
- Do not allow the product to be used with a defective guard, blade disc or body. Neither should it be used with defective blades, screws, nuts or cables. Never connect a damaged cable, or touch a damaged cable before it is disconnected from the supply.
- Do not use the product if the main switch does not work.
- Always switch off the product using the main switch when the product is not in use. The product can only start when the main switch is set to 1 and the correct PIN code has been entered.
- The product must never be used at the same time as a sprinkler. Use the timer function so the product and sprinkler never run simultaneously. Refer to *To do the timer settings on page 24*.
- Husqvarna does not guarantee full compatibility between the product and other types of wireless systems such as remote controls, radio transmitters, hearing loops, underground electric animal fencing or similar.
- The built-in alarm is very loud. Be careful, especially if the product is handled indoors.
- Metal objects in the ground (for example reinforced concrete or anti-mole nets) can result in a stoppage. The metal objects can cause interference with the loop signal which then can lead to a stoppage.
- Operation and storage temperature is 0-50 °C / 32-122 °F. Temperature range for charging is 0-45 °C / 32-113 °F. Too high

temperatures might cause damage to the product.

2.3.2 Battery safety



WARNING: Lithium-ion batteries can explode or cause fire if disassembled, short-circuited, exposed to water, fire, or high temperatures. Handle carefully, do not dismantle, open the battery or use any type of electrical/mechanical abuse. Avoid storage in direct sunlight.

For more information about the battery, refer to *Technical data on page 54*

2.3.3 How to lift and move the product

To safely move from or within the work area:

1. Press the **STOP** button to stop the product.

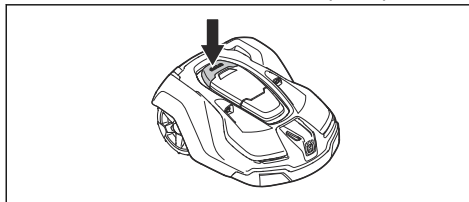

2. Set the main switch in position 0.

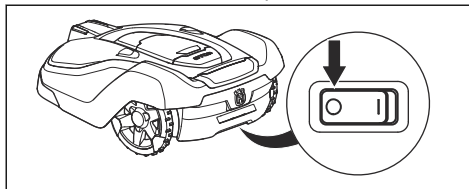

3. Carry the product by the handle under the product with the blade disc away from the body.





CAUTION: Do not lift the product when it is parked in the charging station. It can damage the charging station and/or the product. Press **STOP** and pull the product out of the charging station before lifting it.

2.3.4 Maintenance



WARNING: When the product is turned upside down the main switch must always be in the 0 position.

The main switch should be set in the 0 position before all work on the chassis of the product, such as cleaning or replacing the blades.

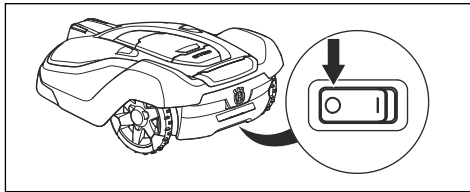

CAUTION: Never use a high-pressure washer or even running water to clean the product. Never use solvents for cleaning.



CAUTION: Use the plug to disconnect the charging station before any cleaning or maintenance of the charging station or the loop wire.

Inspect the product each week and replace any damaged or worn parts. Refer to *Maintenance on page 37*.

2.3.5 In the event of a thunderstorm

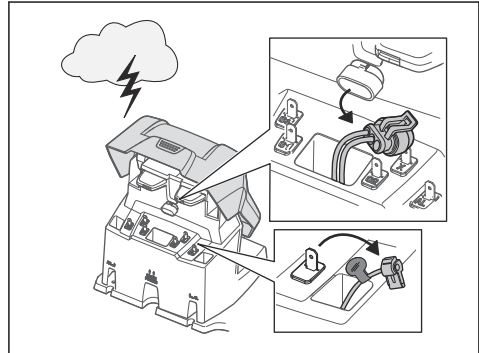

To reduce the risk of damage to electrical components in the product and the charging station, we recommend that all connections to the charging station are disconnected (power supply, boundary wire and guide wire) if there is a risk of a thunderstorm.

1. Mark the wires to simplify reconnecting. The charging station's connections are marked AR, AL and G1. Some models have additional guide wires (G2, G3).
2. Disconnect all connected wires and the power supply.
3. Connect all the wires and the power supply if there is no longer a risk of thunder. It is important that each wire is connected to the right place.

3 Installation

3.1 Introduction - Installation



WARNING: Read and understand the safety chapter before you install the product.



CAUTION: Use original spare parts and installation material.

Note: Refer to www.husqvarna.com for more information about installation.

3.2 Before the installation of the wires

You can select to attach the wires with stakes or bury them. You can use the 2 procedures for the same work area.

- Bury the boundary wire or the guide wire if you are going to use a dethatcher on the work area. If not, attach the boundary wire or guide wire with stakes.
- Cut the grass before you install the product. Make sure that the grass is maximum 10 cm / 4 in.

Note: The first weeks after installation the perceived sound level when cutting the grass may be higher than expected. When the product has cut the grass for some time, the perceived sound level is much lower.

3.3 Before the installation of the product

- Make a blueprint of the work area and include all obstacles.
- Make a mark on the blueprint where to put the charging station, the boundary wire and the guide wire.
- Make an eyelet on the blueprint where the guide wire connects to the boundary wire. Refer to *To install the guide wire on page 21*.
- Fill in holes in the lawn.

Note: Holes with water in the lawn can cause damage to the product.

3.3.1 To examine where to put the charging station

- Keep a minimum 2 m / 7 ft. of free space in front of the charging station.
- Keep a minimum of 1.5 m / 5 ft. of free space to the right and to the left of the charging station.
- Put the charging station near an outdoor power outlet.
- Put the charging station on a level surface.

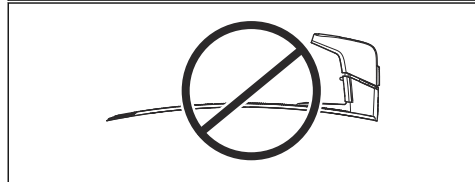
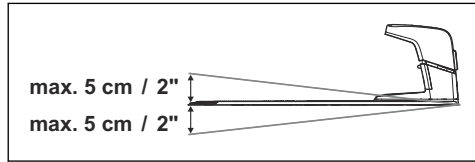

- Put the charging station in the lowest possible section of the work area.
- Put the charging station in an area without an irrigation system.
- Put the charging station in an area with protection from the sun.
- If the charging station is installed on an island, make sure to connect the guide wire to the island. Refer to *To make an island on page 18*.

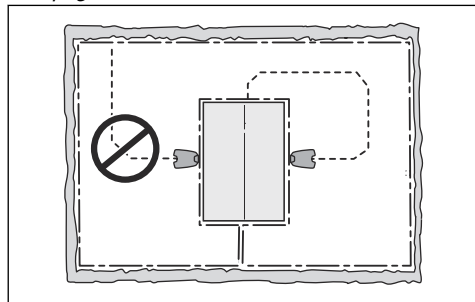

3.3.2 To examine where to put the power supply

- Put the power supply in an area with a roof and protection from the sun and rain.
- Put the power supply in an area with good airflow.
- Use a residual-current device (RCD) when you connect the power supply to the power outlet.



WARNING: Do not change the power supply. Do not cut or extend the low-voltage cable. There is a risk of electrical shock.

Low-voltage cables of different lengths are available as accessories.



CAUTION: Make sure that the blades on the product do not cut the low-voltage cable.



CAUTION: Do not put the low-voltage cable in a coil or below the charging station plate. The coil causes interference with the signal from the charging station.



3.3.3 To examine where to put the boundary wire

The boundary wire should be put as a loop around the work area. Sensors in the product senses when the product approaches the boundary wire, and the product selects another direction.



CAUTION: If the work area is adjacent to water bodies, slopes, precipices or a public road, the boundary wire must have a protective wall. The wall must be minimum 15 cm / 6 in. in height.

To make the connection easier between the guide wire and the boundary wire, it is

recommended to make an eyelet where the guide wire will be connected. Make the eyelet with approximately 20 cm / 8 in. of the boundary wire.

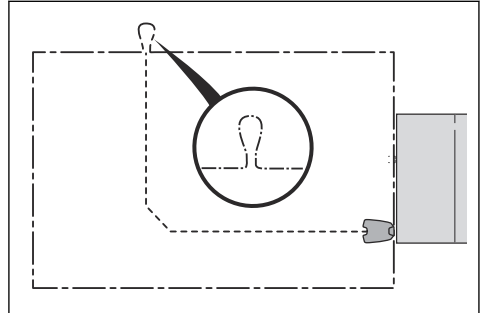

Note: Make a blueprint of the work area before you install the boundary wire and guide wire.

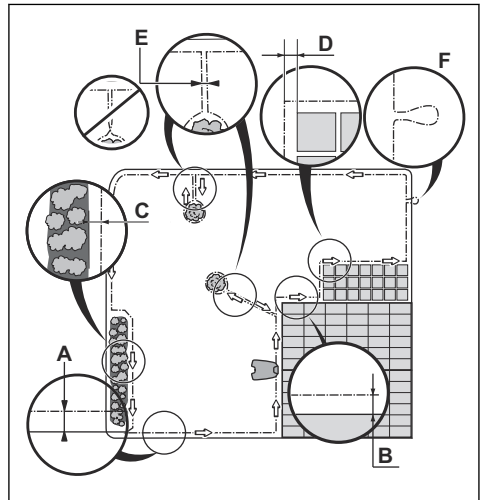

- Put the boundary wire around all of the work area (A). Adapt the distance between the boundary wire and obstacles.
- Put the boundary wire 40 cm / 16 in. (B) from an obstacle that is more than 5 cm / 2 in. high.

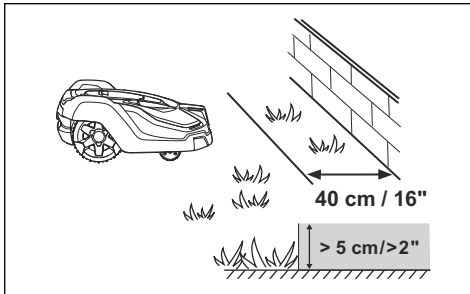

- Put the boundary wire 35 cm / 14 in. (C) from an obstacle that is 1-5 cm / 0.4-2 in. high.
- Put the boundary wire 10 cm / 4 in. (D) from an obstacle that is less than 1 cm / 0.4 in.
- If you have a paving stone path that is in level with the lawn, put the boundary wire below the paving stone.

Note: If the paving stone is minimum 30 cm / 12 in. wide, use the factory setting for the *Drive Past Wire* function to cut all the grass adjacent to the paving stone.



CAUTION: Do not let the product operate on gravel.

- If you make an island, put the boundary wire that runs to and from the island near together (E). Put the wires in the same stake.
- Make an eyelet (F) where the guide wire is to be connected to the boundary wire.



CAUTION: Do not make sharp bends when you install the boundary wire.



CAUTION: For careful operation without noise, isolate all obstacles such as trees, roots and stones.

3.3.3.1 To put the boundary wire in a slope

The product can operate in slopes. Slopes that are too steep must be isolated with the boundary wire. The gradient (%) is calculated as height per m. Example: 10 cm / 100 cm = 10%.

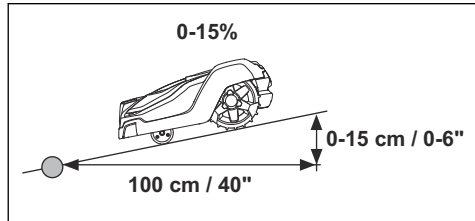

- For slopes steeper than 45% inside the work area, isolate the slope with boundary wire.
- For slopes steeper than 15% along the outer edge of the lawn, put the boundary wire 20 cm / 8 in. (A) from the edge.

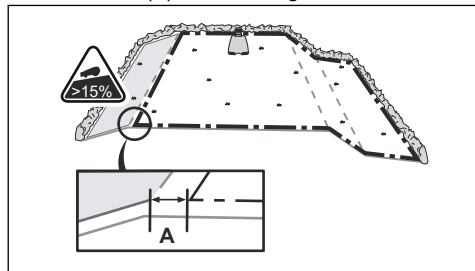

- Slopes adjacent to a public road must be isolated with boundary wire. Put a fence or a protective wall along the outer edge of the slope.

3.3.3.2 Passages

A passage is a section that has boundary wire on each side and that connects 2 work areas. The passage must be a minimum of 60 cm / 24 in. wide.

Note: If a passage is less than 2 m / 6.5 ft. wide, install a guide wire through the passage.

3.3.3.3 To make an island

- Put the boundary wire to and around the obstacle to make an island.
- Put the 2 sections of boundary wire that run to and from the obstacle together.
- Put the 2 sections of boundary wire in the same stake.

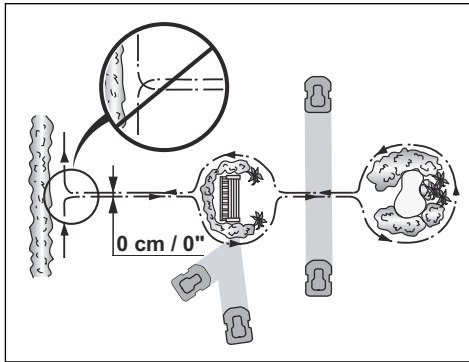

CAUTION: Do not put a section of boundary wire across the other. The sections of boundary wire must be parallel.



CAUTION: Do not put the guide wire across the boundary wire, for example a boundary wire that goes to an island.

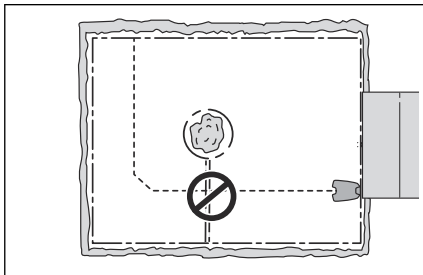

3.3.3.4 To make a secondary area

Make a secondary area (B) if the work area has 2 areas that are not connected with a passage. The work area with the charging station is the main area (A).

Note: The product must be manually moved between the main area and the secondary area.

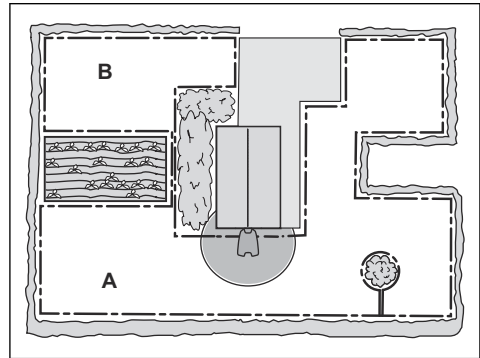

- Put the boundary wire around the secondary area (B) to make an island. Refer to *To make an island on page 18*.

Note: The boundary wire must be put as 1 loop around all of the work area (A + B).

Note: When the product cuts grass in the secondary area, the *Secondary area* mode must be selected. Refer to *Secondary area on page 34*.

3.3.4 To examine where to put the guide wire

- Put the guide wire in a line at a minimum of 2 m / 7 ft. in front of the charging station.
- Make sure that the guide wire has as much free area as possible to the left of the guide wire when facing the charging station. Refer to *To set the corridor width on page 29*.
- Put the guide wire minimum 30 cm / 12 in. from the boundary wire.
- Do not make sharp bends when you install the guide wire.
- If the work area has a slope, put the guide wire diagonally across the slope.

3.3.5 Work area examples

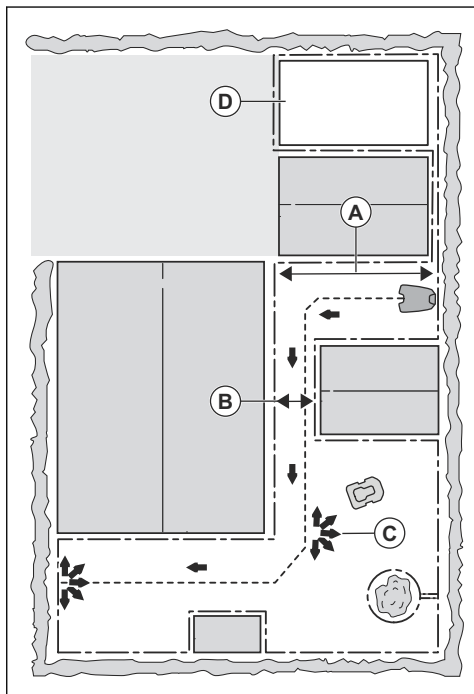

- If the charging station is put in a small area (A), make sure that the distance to the boundary wire is at a minimum 3 m / 10 ft.
- If the work area has a passage (B), make sure that the distance to the boundary wire is at a minimum 2 m / 6.5 ft. If the passage is smaller than 2 m / 6.5 ft., install a guide wire through the passage. Minimum passage between the boundary wire is 60 cm / 24 in.
- If the work area has areas which are connected by a narrow passage (B), you can set the product to leave the guide wire after a certain distance (C). The settings can be changed in *Lawn coverage on page 27*.
- Use the GPS Assisted Navigation. Refer to *Lawn coverage on page 27*.
- If the work area includes a secondary area (D), refer to *To make a secondary area on page 19*. Put the product in the secondary area and select *Secondary area mode*. Refer to *Secondary area on page 34*.

3.4 Installation of the product

3.4.1 To install the charging station



WARNING: Obey national regulations about electrical safety.

1. Read and understand the instructions about the charging station. Refer to *To examine where to put the charging station on page 16*.
2. Put the charging station in the selected area.
3. Connect the low-voltage cable to the charging station.
4. Put the power supply at a minimum height of 30 cm / 12 in.

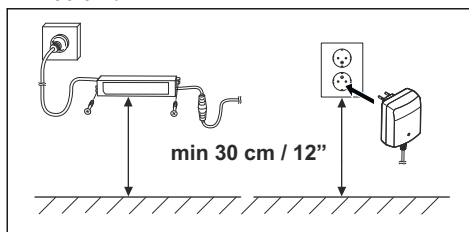

CAUTION: The product is only to be used with the power supply unit supplied by Husqvarna.



WARNING: Do not put the power supply at a height where there is a risk it can be put in water. Do not put the power supply on the ground.



WARNING: Do not encapsulate the power supply. Condensed water can harm the power supply and increase the risk of electrical shock.

5. Connect the power supply cable to a 100-240V outdoor power outlet.



WARNING: Applicable to USA/ Canada. If power supply is installed outdoors: Risk of Electric Shock. Install only to a covered Class A GFCI receptacle (RCD) that has an enclosure that is weatherproof with the attachment plug cap inserted or removed.

- Put the low-voltage cable in the ground with stakes or bury the cable. Refer to *To put the wire into position with stakes on page 22* or *To bury the boundary wire or the guide wire on page 22*.
- Connect the wires to the charging station. Refer to *To install the boundary wire on page 21* and *To install the guide wire on page 21*.
- Attach the charging station to the ground with the supplied screws.



CAUTION: Do not make new holes in the charging station plate.



CAUTION: Do not put your feet on the charging station.

3.4.2 To install the boundary wire

- Put the boundary wire around all of the work area. Start and complete the installation behind the charging station.



CAUTION: Do not put unwanted wire in a coil. The coil causes interference with the product.

- Open the connector and put the boundary wire in the connector.

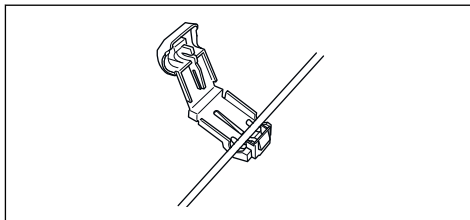

- Close the connector with a pair of pliers.
- Cut the boundary wire 1-2 cm / 0.4-0.8 in. above each connector.

- Put the right end of boundary wire into the channel with the mark "AR".
- Put the left end of boundary wire into the channel with the mark "AL".
- Push the right connector onto the metal pin on the charging station with the mark "AR".
- Push the left connector onto the metal pin on the charging station with the mark "AL".
- Put the cable mark on the left and right boundary wire.

3.4.3 To install the guide wire

- Open the connector and put the wires in the connector.
- Close the connector with a pair of pliers.
- Cut the guide wires 1-2 cm / 0.4-0.8 in. above each connector.
- Put the guide wires centrally below the charging station plate, and push them through the slot in the charging station tower.
- Push the connector onto the metal pin on the charging station with the mark "G1" (if applicable, also for G2 and G3).
- Put the cable mark on the guide wires.
- Put the end of the guide wires at the eyelet on the boundary wire.
- Cut the boundary wire with a pair of wire cutters.
- Connect the guide wires to the boundary wire with a coupler.

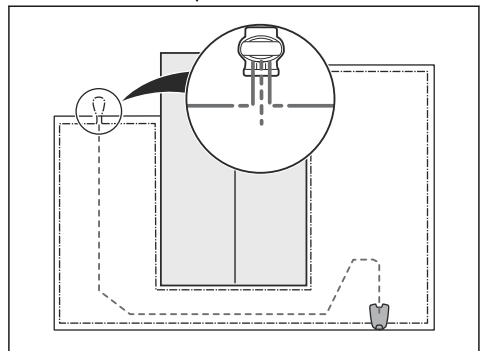

- Put the 2 ends of the boundary wire and the end of the guide wires into the coupler.

Note: Make sure that you can see the end of the guide wires through the transparent area of the coupler.

- b) Push the button on the coupler with an adjustable pliers.
-



CAUTION: Twinned cables, or a screw terminal block that is insulated with insulation tape are not satisfactory splices. Soil moisture will cause the wire to oxidize and after a time result in a broken circuit.

10. Attach the guide wires to the ground with stakes or bury the guide wires in the ground. Refer to *To put the wire into position with stakes on page 22* or *To bury the boundary wire or the guide wire on page 22*.
-

3.5 To put the wire into position with stakes

- Put the boundary wire and the guide wire on the ground.
 - Put the stakes at a maximum of 30 cm / 12 in. distance from each other.
 - Attach the stakes to the ground with a hammer or a plastic mallet.
-



CAUTION: Make sure that the stakes hold the boundary wire and the guide wire against the ground.

Note: The wire is overgrown with grass and not visible after a few weeks.

3.6 To bury the boundary wire or the guide wire

- Cut a groove in the ground with an edge cutter or a straight shovel.
 - Put the boundary wire or the guide wire 1-20 cm / 0.4-8 in. into the ground.
-

3.7 To extend the boundary wire or the guide wire

Note: Extend the boundary wire or the guide wire if it is too short for the work area. Use original spare parts, for example couplers.

1. Cut the boundary wire or the guide wire with a pair of wire cutters where it is necessary to install the extension.
 2. Add wire where it is necessary to install the extension.
 3. Put the boundary wire or the guide wire into position.
 4. Put the wire ends into a coupler.
-

Note: Make sure that you can see the ends of the boundary wire or the guide wire through the transparent area of the coupler.

5. Push the button on the coupler with an adjustable pliers.
-

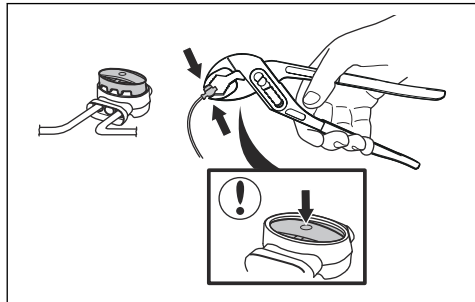

6. Put the boundary wire or the guide wire into position with stakes.
-

3.8 After the installation of the product

3.8.1 To do a visual check of the charging station

1. Make sure that the indicator LED lamp on the charging station has a green light.
 2. If the indicator LED lamp does not have a green light, do a check of the installation. Refer to *LED indicator lamp on the charging station on page 47* and *To install the charging station on page 20*.
-

3.8.2 To do the basic settings

Before you start the product for the first time, you must do the basic settings and calibrate the product.

1. Push the **STOP** button.
2. Set the **Main switch** to 1.
3. Push the **arrow** buttons and the **OK** button. Select *language, country, date, time* and set a PIN code.

Note: It is not possible to use 0000 as PIN code.

4. Put the product in the charging station.
5. Push the **START** button and close the hatch.

Note: Some models require a factory PIN code before the selection of personal PIN code.

Note: Use the MEMO page at the beginning of the manual to make a note of the PIN code. *Introduction on page 3.*

The product then moves away from the charging station and stops, while it calibrates some of the product settings.

3.9 Automower® Connect app

The product can connect to mobile devices that have the Automower® Connect app installed. The app uses long-range cellular connectivity. Automower® Connect is a free app for your mobile device. The Automower® Connect app gives extended functions to your Husqvarna product. You can:

- See the status of your product.
- Change settings to your product.
- Get extended product information.
- Get an alarm if the product moves out of the work area.

To pair the product with the app, refer to *Automower® Connect on page 32* and *To pair Automower® Connect and the product on page 32.*

3.9.1 To install the Automower® Connect app

1. Download the Automower® Connect app on your mobile device.
2. Sign up for a Husqvarna account in the Automower® Connect app.
3. Log in to your Husqvarna account in the Automower® Connect app.

3.9.2 Automower® Connect menu

The main menu in Automower® Connect offers 4 options:

- *Dashboard*
- *Map* (only available with Automower® Connect)
- *Settings*

3.9.2.1 Dashboard

The dashboard shows the current status of the product both visually and in text. It is very easy to control the product by tapping the controls, for example *Park*.

In the lower part of the dashboard there are shortcuts to the *Timer settings* and the *Map*. The dashboard also shows symbols according to below:

1. The battery status shows the remaining battery charge. A flash is shown over the battery symbol when the product charges its battery. A plug is shown over the battery symbol when the product is standing in the charging station without charging.
2. Cutting height.

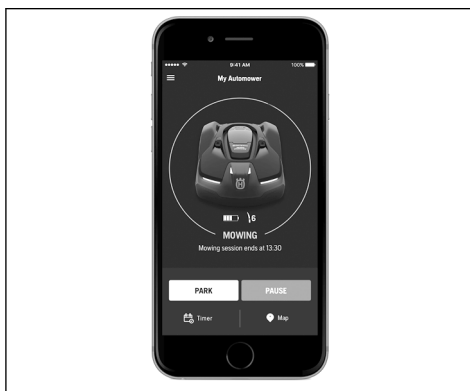

For more information about the operating modes *Start, Park and Pause*, see *Operation on page 34*.

3.9.2.2 Map

The map shows the current position of the product and the set centerpoint (origin) for GeoFence.

3.9.2.3 Settings in Automower® Connect



The product has factory settings but the settings can be adapted to each work area.

Most of the settings in the Automower® Connect app can be set in the display of the product. Refer to *To do the product settings on page 24*.

3.10 To do the product settings

The product has factory settings but the settings can be adapted to each work area.

3.10.1 To get access to the menu

1. Push the **STOP** button.
2. Enter the PIN code on the keypad.
3. Push the **MENU** button.

3.10.2 To do the timer settings



3.10.2.1 To calculate the timer setting

1. Calculate the dimension of your lawn in m^2 / yd^2 .
2. Divide the m^2 / yd^2 of the lawn with the approximate operation capacity. Refer to table below.
3. The result is equal to the number of hours that the product must operate each day.

Note: The operation capacity is approximate and timer settings can be adjusted.

Model	Approximate operation capacity, m^2/h / yd^2/h
Automower® 430XH	133 / 159
Automower® 450XH	208 / 248

Example: A lawn of $1000 m^2$ / $1200 yd^2$, cut with a Automower® 430XH.

$1000 m^2$ / 133 \approx 7.5 h.

$1200 yd^2$ / 159 \approx 7.5 h.

Days / week	h / day	Timer settings
7	7.5	07:00 - 14:30 / 07:00 am - 2:30 pm

3.10.2.2 To set the timer

1. Do steps 1–3 in *To get access to the menu on page 24*.
2. Use the **arrow** buttons and the **OK** button to move through the menu structure *Timer > Overview Timer settings*.
3. Use the **arrow** buttons and the **OK** button to select the day.
4. Use the **arrow** buttons and the **OK** button to select the time period.
5. Enter the time with the **number** buttons. The product can cut the grass 1 or 2 periods each day.

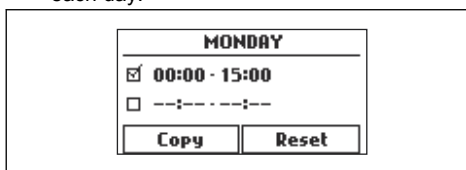

6. If the product must not cut grass on a specified day, unselect the box adjacent to the 2 time periods.

3.10.2.3 To copy the timer setting

1. Do steps 1–3 in *To get access to the menu on page 24*.
2. Use the **arrow** buttons and the **OK** button to move through the menu structure *Timer > Overview Timer settings > Overview > Copy to*.

- Use the **arrow** buttons and the **OK** button to copy the timer setting. You can copy the timer settings day to day or for the full week.

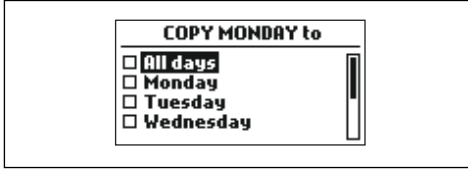

3.10.2.4 To reset the timer setting

You can remove all timer settings and use the factory setting. The factory timer setting lets the product to operate all hours of each day of the week. Refer to *To do the timer settings on page 24*.

- Do steps 1–3 in *To do the basic settings on page 23*.
- Use the **arrow** buttons and the **OK** button to move through the menu structure *Timer > Overview Timer settings > Overview > Reset timer*.
 - Push the **arrow** buttons to select *Current day* to only set the current day to factory settings.
 - Push the **arrow** buttons to select *All week* to reset all timer settings to factory settings.
- Push the **OK** button.

3.10.3 Cutting height



The cutting height can be varied from MIN (2 cm / 0.8 in.) to MAX (6 cm / 2.5 in.).

Note: The height adjustment setting is shown in the display of the product as a scale/numerical value.



CAUTION: During the first weeks after a new installation, the cutting height must be set to MAX to avoid damaging the loop wire. After this, the cutting height can be lowered step by step every week until the desired cutting height has been reached.

3.10.3.1 To set the cutting height

- Do steps 1–3 in *To get access to the menu on page 24*.
- Use the **arrow** buttons and the **OK** button to move through the menu structure *Cutting height*.
- Use the **arrow** buttons to set the cutting height.
- Push the **OK** button.

3.10.4 Security level



There are 3 security levels for the product *Low, Medium and High* or you can select your settings in *Custom*.

Function	Low	Medium	High
Alarm			X
PIN-code		X	X
Time lock	X	X	X

- Alarm** - An alarm goes off if the PIN-code is not entered within 10 seconds after the **STOP** button is pushed. The alarm also goes off when the product is lifted. The alarm stops when the PIN-code is entered.
- PIN-code** - The correct PIN-code must be entered to get access to the Menu structure of the product. If the incorrect PIN-code is entered 5 times, the product is locked for a time. The lock is extended for each new incorrect try.
- Time lock** - The product locks if the PIN-code has not been entered in 30 days. Enter the PIN-code to get access to the product.

3.10.4.1 To set the security level

Select 1 of 3 security levels for your product.

- Do steps 1–3 in *To get access to the menu on page 24*.
- Use the **arrow buttons** and the **OK** button to move through the menu structure *Settings > Security > Security level*.
- Use the **arrow buttons** and the **OK** button to select the level of security.

4. Push the **OK** button.

3.10.4.2 To change the PIN-code

1. Do steps 1–3 in *To get access to the menu on page 24*.
2. Use the **arrow buttons** and the **OK** button to move through the menu structure *Settings > Security > Advanced > Change PIN-code*.
3. Enter the new PIN code.
4. Push the **OK** button.
5. Enter the new PIN code.
6. Push the **OK** button.
7. Make a note of the new PIN code. Refer to *Introduction on page 3*.

3.10.4.3 To create a New loop signal

The loop signal is randomly selected to create a unique link between the product and the charging station. In rare cases, there may be a need to generate a new signal, for instance if two adjacent installations have a very similar signal.

1. Place the product in the charging station.
2. Do steps 1–3 in *To get access to the menu on page 24*.
3. Use the **arrow buttons** and the **OK** button to move through the menu structure *Security > Advanced > New loop signal*.
4. Await confirmation that the loop signal has been generated. This normally takes about 10 seconds.

3.10.4.4 To set duration of alarm and time lock

1. Do steps 1–3 in *To get access to the menu on page 24*.
2. Use the **arrow buttons** and the **OK** button to move through the menu structure *Security > Advanced > Duration*.
3. Enter the time for the *Duration of alarm* with the **number** buttons. You can select a number between 1 to 10 minutes.
4. Use the **arrow buttons** to select *Duration of time lock*.
5. Enter the time for the *Duration of time lock* with the **number** buttons. You can select a number between 1 to 100 days. The factory setting is 30 days.

3.10.5 Messages



In this menu the previous fault and information messages can be found. For some of the messages, there are tips and advice to help to rectify the fault. Refer to *Troubleshooting on page 40*.

If the product is disrupted in any way, for example it is trapped or the battery is low, a message is saved relating to the disruption and the time it happened.

If the same message is repeated several times, this may indicate that an adjustment to the installation or the product is required. Refer to *Installation on page 16*.

3.10.5.1 To read the messages

1. Do steps 1–3 in *To get access to the menu on page 24*.
2. Use the **arrow buttons** and the **OK** button to move through the menu structure *Messages > Fault messages and Messages > Info messages*.
3. Read the messages and read the *Troubleshooting* to get information and recommendations to correct the faults.

3.10.6 Weather timer



The *Weather timer* allows the product to automatically adjust its mowing time based on how fast the grass grows.

When the *Weather timer* is activated, the product needs time to decide the optimal mowing time for the work area in question. For this reason it can take a couple of days before mowing is optimized for the *Weather timer*.

The product cannot operate longer than the timer settings. It is therefore recommended to only deselect the times when the product must not operate. All other time should be made available for the *Weather timer*.

When the *Weather timer* is activated, it is very important to regularly check that the blade disc is clean and that the blades are in good condition.

Any grass twisted around the blade disc shaft, or blunt blades, can affect the *Weather timer*.

Note: If the mowing results are not satisfying, the cutting time can be adjusted to mow for a longer time (*High*) or for a shorter time (*Low*).

3.10.6.1 To set the Weather timer

1. Do steps 1–3 in *To get access to the menu on page 24*.
2. Use the **arrow** buttons and the **OK** button to move through the menu structure *Weather timer > Use*.
3. Push the **OK** button to select *Weather timer*.
4. Use the **arrow** buttons to set the cutting time. You can select between *Low, Mid, High*.

3.10.7 Installation



In the Installation menu it is possible to adapt the settings of the product for best mowing result.

3.10.7.1 Lawn coverage

GPS Assisted Navigation helps the product to select the most optimal operation. Refer to *To disable and enable the GPS function on page 27*. In more complex gardens operation can be improved by carrying out some of the manual settings in the *Lawn coverage* menu.

The *Lawn coverage* function is used to guide the product to remote parts of the work area. If the work area includes areas that are connected with narrow passages, the *Lawn coverage* function is useful to be able to maintain a well-cut lawn in all parts of the yard. The product begins to mow when it reaches the *Lawn coverage* point. At all other times, the product leaves the charging station in the standard manner and starts to mow.

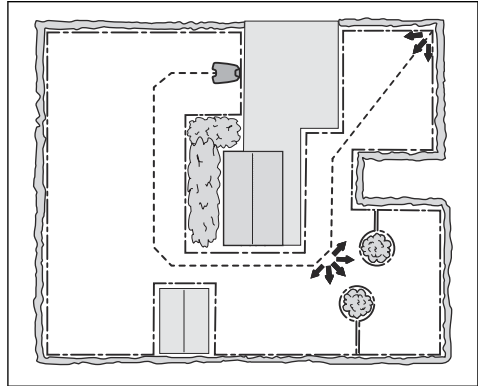

To disable and enable the GPS function

Disable the GPS Assisted Navigation to make manual settings in *Lawn Coverage*.

Note: It is recommended to use GPS Assisted Navigation.

1. Do steps 1–3 in *To get access to the menu on page 24*.
2. Use the **arrow** buttons and the **OK** button to move through the menu structure *Installation > Lawn Coverage*.
3. Push the **OK** button to disable or enable the GPS Assisted Navigation.

Note: When GPS assisted navigation is enabled it is used as long as there is a GPS service. The GPS assisted navigation is used even if manual settings have been made. Only when GPS service is not available, the manual settings are used.

To set the Lawn coverage function

1. Do steps 1–3 in *To get access to the menu on page 24*.
2. Use the **arrow** buttons and the **OK** button to move through the menu structure *Installation > Lawn coverage > Area 1-5*.
3. Use the left **arrow** button to select the area.
4. Push the **OK** button.
5. Measure the distance from the charging station to the start of the area. Measure along the guide wire. Refer to *To measure*

the distance from the charging station on page 28.

6. Push the **number** buttons to select the distance, measured in m.
7. Use the **number** buttons to select the % of the cutting time the product must cut the area. The % is equal to the percentage of the area in relation to the complete work area.
 - a) Measure the area.
 - b) Divide the area with the work area.
 - c) Convert the result to %.

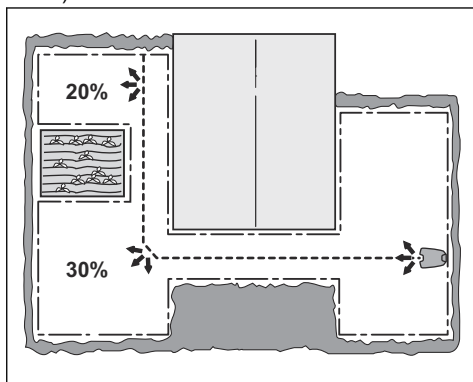

To do a test of the Lawn coverage function

1. Put the product in the charging station.
2. Do step 1-3 in *To get access to the menu on page 24*.
3. Use the **arrow** buttons and the **OK** button to move through the menu structure *Installation > Lawn coverage > Area 1-5 > More > Test*.
4. Push the **OK** button.
5. Push the **START** button.
6. Close the hatch.
7. Make sure the product can find the area.

To measure the distance from the charging station

1. Put the product in the charging station.
2. Do steps 1-3 in *To get access to the menu on page 24*.
3. Use the **arrow** buttons and the **OK** button to move through the menu structure *Installation > Lawn coverage > Area 1-5 > How far?*
4. Use the **number** buttons to set m as a distance.

5. Push the **OK** button.
6. Push the **BACK** button.
7. Use the **arrow** buttons and the **OK** button to move through the menu structure *Installation > Lawn coverage > Area 1-5 > More > Test*.
8. Push the **OK** button.
9. Push the **START** button and close the hatch.
10. Push the **STOP** button when the product is at the distance you select to measure. The distance shows in the display.

To disable or enable the Lawn coverage function

Disable the *Lawn coverage* function for each area.

1. Do steps 1-3 in *To get access to the menu on page 24*.
2. Use the **arrow** buttons and the **OK** button to move through the menu structure *Installation > Lawn coverage > Area 1-5 > Disable*.
3. Use the left **arrow** button to disable or enable the *Lawn coverage* function.
4. Push the **OK** button.
5. Push the **BACK** button.

3.10.7.2 Finding the charging station

The product can be set to search for the charging station in one or more of the following three ways:

1. Charging station signal
2. Follow boundary wire
3. Follow guide wire

The default settings are set so that these 3 search options are combined to find the charging station as fast as possible, but also with a minimum risk of tracks forming on the lawn. The product always starts by searching for the *Charging station signal*. After a specified time delay, it also uses *Follow guide* and *Follow boundary wire*.

Common causes why the product cannot follow the wire are:

- Obstacles close to the wire have not been isolated.
- The charging station, the boundary wire or the guide wire is not installed in accordance with the instructions in *To install the charging station on page 20*, *To install the*

boundary wire on page 21 and in *To install the guide wire on page 21.*

To set the delay time for the guide wire and the boundary wire

1. Do steps 1–3 in *To get access to the menu on page 24.*
2. Use the **arrow** buttons and the **OK** button to move through the menu structure *Installation > Find the charging station.*
3. Use the right and left **arrow** buttons to select *Guide* or *Boundary*.
4. Push the **OK** button.
5. Enter the time with the **number** buttons.
6. Push the **BACK** button.

To disable the guide wire and boundary wire

1. Do steps 1–3 in *To get access to the menu on page 24.*
2. Use the **arrow** buttons and the **OK** button to move through the menu structure *Installation > Find the charging station > Guide* or *Boundary*.
3. Use the **arrow** buttons to select *Disable*.
4. Push the **OK** button.

To test if the product can find the charging station

In the test the product follows the guide wire or the boundary wire to the charging station.

1. Do steps 1–3 in *To get access to the menu on page 24.*
2. Put the product 3 m / 9 ft. from the guide wire or the boundary wire.
3. Use the **arrow** buttons and the **OK** button to move through the menu structure *Installation > Find the charging station > Guide* or *Boundary > More*.
4. Use the **arrow** buttons to select *Guide* or *Boundary*.
5. Push the **OK** button.
6. Push the **START** button and close the hatch.

Make sure that the product follows the wire to the charging station and that the product docks with the charging station at first try.

To reset the settings for the guide wire and the boundary wire

1. Do steps 1–3 in *To get access to the menu on page 24.*

2. Use the **arrow** buttons and the **OK** button to move through the menu structure *Installation > Find the charging station > Guide* or *Boundary > More*.
3. Use the **arrow** buttons to select *Reset*.
4. Push the **OK** button.

To change the signal range of the charging station

For some installations it is necessary to decrease the signal of the charging station. For example when the charging station is put near a bush or wall which prevents the product from docking with the charging station.

Note: It is usually better to move the charging station, than to decrease the range of the charging station signal.

1. Do steps 1–3 in *To get access to the menu on page 24.*
2. Use the **arrow** buttons and the **OK** button to move through the menu structure *Installation > Find the charging station > Charger*.
3. Use the left **arrow** button to select *Max*, *Mid* or *Min*.
4. Push the **BACK** button.

3.10.7.3 Advanced

Corridor width

To set the corridor width

The boundary wire corridor is the area adjacent to the boundary wire and the guide corridor is the area adjacent to the guide wire. The product uses the corridors to find the charging station. When the product moves in the direction of the charging station, it always moves to the left of the guide wire.

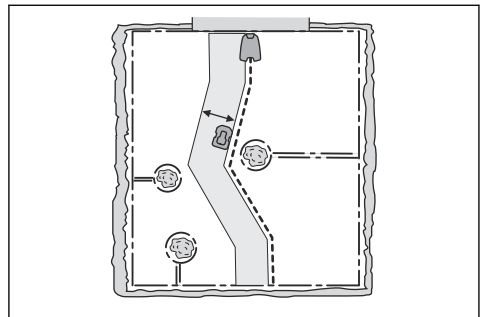

The corridor width is adjusted automatically. Only in rare occasions manual settings need to be entered. The corridor width can be set between 0-9. If guide corridor width is set to 0, the product runs over the guide wire. The factory setting is 6 for the boundary wire and 9 for the guide wire.

1. Do steps 1–3 in *To get access to the menu on page 24*.
2. Use the **arrow** buttons and the **OK** button to move through the menu structure *Installation > Advanced > Corridor width*.
3. Use the **arrow** buttons to select a corridor.
4. Use the **number** buttons to select a corridor width of 0-9.

Note: Make the corridor width as wide as possible for a minimum risk of lines in the lawn.

Exit angles

In the factory setting the product leaves the charging station in a direction in the 90°-270° exit sector. Change the exit angles to make it easier for the product to find the work areas.

If the charging station is put in a passage, 2 exit angles, for example 70°-110° and 250°-290°, can be used.

When 2 exit angles are used, it is necessary to set how frequently the product must leave the charging station in *Sector 1*. Use the *Proportion* function to set how frequently the product must use each sector. Set in %.

For example 75% means that the product leaves the charging station in *Sector 1* on 75% of the times and 25% of the times in *Sector 2*.

To set the exit angles

The product moves away from the charging station with an exit angle between 90°–270°. The exit angles can be set to 1–2 exit sectors.

1. Do steps 1–3 in *To get access to the menu on page 24*.
2. Use the **arrow** buttons and the **OK** button to move through the menu structure *Installation > Advanced > Exit angles > Sector 1 or 2*.
3. Use the **number** buttons to set the angles in degrees.
4. Push the down **arrow** button.

5. Use the **number** buttons to select how frequently the product must use each sector. Set in %.
6. Push the **BACK** button.

To set the reversing distance

The reversing distance is how many cm the product reverses when it leaves the charging station. The factory setting is 60 cm.

1. Do steps 1-3 in *To get access to the menu on page 24*.
2. Use the **arrow** button and the **OK** button to move through the menu structure *Installation > Advanced > Reversing distance*.
3. Use the **number** buttons to set the reverse distance in cm.
4. Push the **BACK** button.

To set the Drive Past Wire function

The front of the product always moves past the boundary wire by a specified distance before the product moves back into the work area. The factory setting is 31 cm. You can select a distance of 20-50 cm.

1. Do steps 1–3 in *To get access to the menu on page 24*.
2. Use the **arrow** button and the **OK** button to move through the menu structure *Installation > Advanced > Drive Past Wire*.
3. Use the **number** buttons to set the distance in cm.
4. Push the **BACK** button.

3.10.8 Settings



In settings you can change the general settings to your product.

3.10.8.1 Profiles

Different sets of product settings can be saved if the product is used in different work areas with different charging stations. You can set a maximum of 3 profiles.

To save settings to a profile

1. Do steps 1–3 in *To get access to the menu on page 24*.

2. Use the **arrow** buttons and the **OK** button to move through the menu structure *Settings > Profiles > Use > Profile A, B or C*.
3. Select a profile and push the **OK** button.
4. Select *Save* and push the **OK** button.

Note: If the settings that are not stored to the profile are made, the symbol * is shown beside the profile name.

To use a profile

1. Do steps 1–3 in *To get access to the menu on page 24*.
2. Use the **arrow** buttons and the **OK** button to move through the menu structure *Settings > Profiles > Use > Profile A, B or C > Select*.

3.10.8.2 ECO mode

ECO mode stops the signal in the boundary loop, the guide wire and the charging station, when the product is parked or is charging.

Note: Use *ECO mode* to save energy and avoid interference with other equipment, for example hearing loops or garage doors.

Note: Push the **STOP** button before you remove the product from the charging station. If not, the product can not be started in the work area.

To set the ECO mode

1. Do steps 1–3 in *To get access to the menu on page 24*.
2. Use the **arrow** buttons and the **OK** button to move through the menu structure *Settings > ECO mode*.
3. Push the **OK** button to select *ECO mode*.

3.10.8.3 Spiral Cutting

The product cuts the grass in a spiral pattern if the grass is longer in an area. *Spiral cutting* can be set in 5 levels:

- Low-
- Low
- Mid
- High
- High+

The level sets how sensitive the product is to changes in grass height.

Note: *Spiral cutting* is only started in the Main area mode. Cutting in the *Secondary area* mode does not let the product to start *Spiral cutting*. *Spiral Cutting* does not start in slopes steeper than 15%.

To set the level of Spiral Cutting

1. Do steps 1–3 in *To get access to the menu on page 24*.
2. Use the **arrow** buttons and the **OK** button to move through the menu structure *Settings > Spiral Cutting > Use > Intensity*.
3. Use the **arrow** buttons to select the level of *Spiral Cutting*.

3.10.8.4 Slope Control

The *Slope Control* function decreases lawn wear in slopes. *Slope Control* is enabled in the factory settings.

To enable or disable the Slope control

1. Do steps 1–3 in *To get access to the menu on page 24*.
2. Use the **arrow** buttons and the **OK** button to move through the menu structure *Settings > Slope control > Use*.

3.10.8.5 General

In *General* you can change the general settings of the product.

To set the time & date

1. Do steps 1–3 in *To get access to the menu on page 24*.
2. Use the **arrow** buttons and the **OK** button to move through the menu structure *Settings > General > Time & Date*.
3. Use the **number** buttons to set the time and then push the **BACK** button.
4. Use the **number** buttons to set the date and then push the **BACK** button.
5. Use the **arrow** buttons to set the time format and then push the **BACK** button.
6. Use the **arrow** buttons to set the date format and then push the **BACK** button.

To set the language

1. Do steps 1–3 in *To get access to the menu on page 24*.
2. Use the **arrow** buttons and the **OK** button to move through the menu structure *Settings > General > Language*.
3. Use the **arrow** buttons to select language and then push the **BACK** button.

To set the Country & Timezone

1. Do steps 1–3 in *To get access to the menu on page 24*.
2. Use the **arrow** buttons and the **OK** button to move through the menu structure *Settings > General > Country & Timezone*.
3. Use the **arrow** buttons to select country and then push the **BACK** button.

To reset all user settings

1. Do steps 1–3 in *To get access to the menu on page 24*.
2. Use the **arrow** buttons and the **OK** button to move through the menu structure *Settings > General > Reset all user settings?*
3. Use the right **arrow** button to select *Proceed with reset of all user settings?*
4. Push the **OK** button to reset all the user settings.

Note: *Security level, PIN code, Loop signal, Messages, Date & Time, Language and Country settings* are not reset.

The About menu

The *About* menu displays information about the product, for example serial number and firmware versions.

3.10.9 Accessories



Settings for accessories mounted on the product can be made in this menu.

3.10.9.1 Information

This menu handles accessories mounted on the product. Contact your local Husqvarna representative for more information on available accessories.

3.10.9.2 Automower® Connect

Automower® Connect is always connected to your product as long as the mobile device have connection with the mobile network, the product is charged and main switch is set in position 1.

To pair Automower® Connect and the product

1. Do steps 1–3 in *To get access to the menu on page 24*.
2. Use the **arrow** buttons and the **OK** button to move through the menu structure *Accessories > Automower® Connect > Pairing > New pairing*.
3. Follow the instructions in the app.

To set the Geofence level of sensitivity

The higher level of Geofence sensitivity, the easier the alarm starts.

1. Do steps 1–3 in *To get access to the menu on page 24*.
2. Use the **arrow** buttons and the **OK** button to move through the menu structure *Accessories > Automower Connect > Geofence*.
3. Put the product in the center of the work area.
4. Select *New center point* and push the **OK** button to set the source of the Geofence.
5. Use the **arrow** buttons to select level of Geofence sensitivity.

To use the SMS function

The SMS function sends you an SMS when the product is moved out of the GeoFence.

1. Do steps 1–3 in *To get access to the menu on page 24*.
2. Use the **arrow** buttons and the **OK** button to move through the menu structure *Accessories > Automower Connect > Communication > Use SMS*.
3. Push the **OK** button.
4. Use the **arrow** buttons and the **OK** button to move through the menu structure *Accessories > Automower Connect > Communication > SMS phone numbers*.
5. Push the **number** buttons to enter the telephone number with country code. For example (+)46701234567.
6. Push the **BACK** button.

Note: There is a maximum of 10 SMS each month from the product.

Network SIM PIN

This menu is only applicable if you use a non-Husqvarna SIM.

APN settings

The product must specify APN settings to be able to use and send data via the mobile net. Settings for Husqvarna SIM is default.

To reset the Automower® Connect settings

1. Do steps 1–3 in *To get access to the menu on page 24*.
2. Use the **arrow** buttons and the **OK** button to move through the menu structure *Accessories > Automower Connect > Reset*.
3. *Proceed with reset of Automower Connect settings* when you select **YES**.
4. Push the **OK** button.

3.10.9.3 Headlights

To set the schedule for the headlights

1. Do steps 1–3 in *To get access to the menu on page 24*.
2. Use the **arrow** buttons and the **OK** button to move through the menu structure *Accessories > Headlights > Schedule*.
3. Select between *Always ON, Evening only, Evening & night* or *Always OFF*.

Note: *Evening only* will start the schedule for the headlights at sunset and stop at midnight. *Evening & night* will start the schedule for the headlights at sunset and stop at sunrise.

To set the Flashes when fault function

The headlights flashes if the product stops to operate because of a fault if *Flashes when fault* is enabled.

1. Do steps 1–3 in *To get access to the menu on page 24*.
2. Use the **arrow** buttons and the **OK** button to move through the menu structure *Accessories > Headlights > Flashes when fault*.
3. Use the **OK** button to enable or disable the *Flashes when fault* function.

3.10.9.4 Ultrasonic (Automower® 450XH)

The *Ultrasonic* function makes the product decrease speed when the product comes near an obstacle. The product operates at a lower speed if the *Ultrasonic* function is disabled.

To set the Ultrasonic function

1. Do steps 1–3 in *To get access to the menu on page 24*.
2. Use the **arrow** buttons and the **OK** button to move through the menu structure *Accessories > Ultrasonic > Use*.

3.10.9.5 Mower house

When this option is enabled, the wear on the product and the house is reduced, but it can result in more uncut grass around the charging station.

To avoid collisions with the mower house

1. Do steps 1–3 in *To get access to the menu on page 24*.
2. Use the arrow buttons and the **OK** button to move through the menu structure *Accessories > Mower house > Avoid collisions with mower house*.

4 Operation

4.1 Main switch



WARNING: Read the safety instructions carefully before you start the product.



WARNING: Keep your hands and feet away from the rotating blades. Never put your hands or feet close to or under the product when the motor is running.



WARNING: Do not use the product when persons, especially children, or animals, are in the work area.

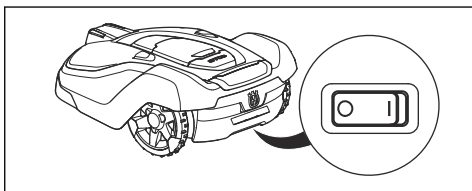

- Set the **Main switch** in the *1* position to start the product.
- Set the **Main switch** in the *0* position when the product is not in use or before any work, inspection or maintenance is being carried out.

When the **Main switch** is set in the *0* position the motors on the product cannot start.

4.2 To start the product

1. Press the **STOP** button to open the hatch.
2. Set the main switch to position *1*.
3. Enter the PIN code.
4. Press the **START** button.

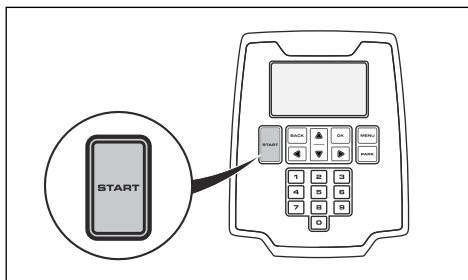

5. Select the desired operating mode. Refer to *Operating mode - Start on page 34*.

6. Close the hatch within 10 seconds.

If the product is parked in the charging station, it will only leave the charging station when the battery is fully charged and if the timer is set to allow the product to operate.

Note: Always press the **START** button before closing the hatch to start the product.

4.3 Operating mode - Start

When the **START** button has been pushed the following operation selections can be selected.

- Main area
- Secondary area
- Override timer
- Spot cutting

4.3.1 Main area

Main area is the standard operating mode where the product mows and charges automatically.

4.3.2 Override timer

The timer settings can be temporarily overridden by selecting *Override timer*. It is possible to override the timer for 24 h or 3 days.

4.3.3 Secondary area

In the *Secondary area* mode, the product operates until the battery is empty.

When the battery is empty, the product stops and the message *Needs manual charging* shows in the product display. Put the product in the charging station to charge the battery.

If the product charges in the *Secondary area* mode, it will fully charge, move out about 50 cm / 20 in. and then stop. This means that the product is charged and prepared to start to cut.

Note: It is recommended to change the operation selection to *Main area* before you put the product in the charging station.

4.3.4 Spot cutting

Spot cutting means that the product mows in a spiral pattern in order to cut the grass in the area where it was started. You can select how the product must continue to operate when cutting is complete.

- Use the right **arrow** button to select *Main Area* or *Secondary Area*.

4.4 Operating mode - Park

When selecting *Park* the following operation selections can be selected:

- Park until further notice
- Start again in 3 hours
- Start with next timer

4.4.1 Park until further notice

The product stays in the charging station until another operating mode is selected by pressing the **START** button.

4.4.2 Start again in 3 hours

The product stays in the charging station for 3 hours and then automatically goes back to the usual operation. This operation selection is applicable when it is necessary to pause operation.

4.4.3 Start with next timer

The product stays in the charging station and starts to operate on the next *Timer* setting.

4.5 To stop the product

1. Press the **STOP** button on top of the product.

The product stops and the blade motor stops.

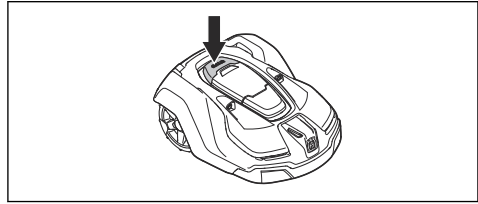

4.6 To switch off the product

1. Press the **STOP** button on top of the product.
2. Set the **Main switch** to position 0.

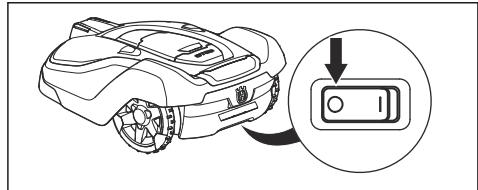

WARNING: Always switch off the product using the main switch if it requires maintenance, or if the product must be moved outside the work area.

4.7 To charge the battery

When the product is new or has been stored for a long period, the battery can be empty and needs to be charged before starting. In the *Main area* mode, the product automatically alternates between mowing and charging.



WARNING: Only charge the product using a charging station and a power supply which is intended for it. Incorrect use may result in electric shock, overheating or leakage of corrosive liquid from the battery.

In the event of leakage of electrolyte flush with water and seek medical help if it comes in contact with the eyes etc.

1. Set the **Main switch** to position 1.
2. Place the product in the charging station.
3. Open the hatch and slide the product in as far as possible to ensure proper contact between the product and the charging station.

-
-
-
4. The display shows a message that charging is in progress.

5 Maintenance

5.1 Introduction - maintenance

For better operating reliability and longer service life: check and clean the product regularly and replace worn parts if necessary. All maintenance and servicing must be done according to Husqvarna's instructions. Refer to *Maintenance on page 37*.

It is important that the blade disc rotates easily. The edges of the blades should not be damaged. The lifetime of the blades varies immensely and depends for instance on:

- Operating time and size of the work area.
- Type of grass and seasonal growth.
- Soil, sand and use of fertilizers.
- The presence of objects such as toys, tools, stones, roots and the like.

The normal life is 2 to 5 weeks when used under favorable conditions. Refer to *Replace the blades on page 38* on how to replace the blades.



WARNING: Wear protective gloves.

Note: Working with blunt blades gives a poorer mowing result. The grass is not cut cleanly and more energy is needed, resulting in the product not being able to maintain such a large area.

5.2 Clean the product

It is important to keep the product clean. A product with large amounts of grass stuck to it will not cope as well with slopes. It is recommended to clean using a brush.

Husqvarna offers a special cleaning and maintenance kit as an accessory. Contact your Husqvarna central service.



CAUTION: Never use a high-pressure washer to clean the product. Never use solvents for cleaning.

5.2.1 Chassis and blade disc

Inspect the blade disc and blades once a week.

1. Set the **Main switch** to position 0.

2. Lift the product onto its side.
3. Clean the blade disc and chassis using for example a dish brush. At the same time, check that the blade disc rotates freely in relation to the foot guard. Also, check that the blades are intact and can pivot freely.

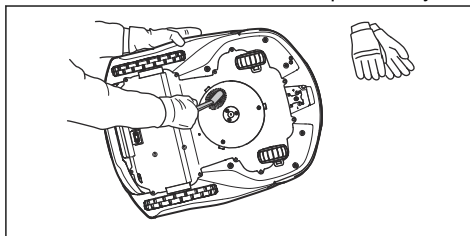

5.2.2 Chassis

Clean the underside of the chassis. Brush or wipe with a damp cloth.

5.2.3 Wheels

Clean around the front wheels and rear wheel as well as the rear wheel bracket. Grass on the wheels can impact on how the product performs in slopes.

5.2.4 Cover

Use a damp, soft sponge or cloth to clean the cover. If the cover is very dirty it may be necessary to use a soap solution or washing-up liquid.

5.2.5 Charging station

Clean the charging station regularly from grass, leaves, twigs and other objects that may impede docking.



WARNING: Use the plug to disconnect the charging station before any maintenance, or cleaning of charging station or power supply.

5.3 Replace the blades



WARNING: Use blades and screws of the right type. Husqvarna can only guarantee safety when using original blades. Only replacing the blades and reusing the screw can result in a screw wearing during mowing. The blades can then be propelled from under the blade and cause serious injury.

Replace worn or damaged parts for safety reasons. Even if the blades are intact, they should be replaced on a regular basis for the best mowing result and low energy usage. All 3 blades and screws must be replaced at the same time to obtain a balanced cutting system. Use Husqvarna original blades embossed with the crowned H-mark logotype, refer to *Technical data on page 54*.

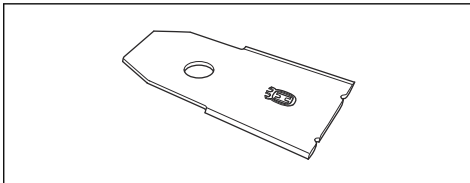

5.3.1 To replace the blades

1. Set the **Main switch** to position 0.

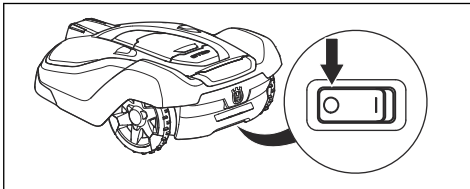

2. Turn the product upside down. Place the product on a soft and clean surface to avoid scratching the body and the hatch.
3. Rotate the skid plate so that its holes align with the screws for the blade.
4. Remove the 3 screws. Use a manual straight slot or cross-tip screwdriver.

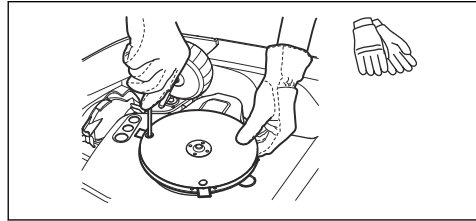

5. Remove each blade and screw.
6. Fasten new blades and screws.
7. Check that the blades can pivot freely.

5.4 Battery



WARNING: Only charge the product using a charging station and power supply which is intended for it. Incorrect use may result in electric shock, overheating or leakage of corrosive liquid from the battery. In the event of leakage of electrolyte flush with water and seek medical help if it comes in contact with the eyes etc.



WARNING: Use only original batteries recommended by the manufacturer. Product safety cannot be guaranteed with other batteries. Do not use non-rechargeable batteries.



CAUTION: The battery must be charged fully before winter storage. If the battery is not fully charged it can be damaged and in certain cases be rendered useless.

The charging time can vary depending on, among other factors, the ambient temperature.

Below indicates that the battery is getting old and eventually needs replacing:

- The operating time for the product is shorter than normal between charges. This leads to more charging cycles than normal, which increases the risk of tracks forming near the charging station.
- The product is found standing out on the lawn with *Empty battery* message. This indicates that the product does not have

battery capacity enough to find the charging station.

The battery is fine as long as the product maintains a well-cut lawn.

Note: Battery life is dependent on the length of the season and how many hours a day the product is operating. A long season or many hours of use a day means that the battery must be replaced more regularly.

Contact your local Husqvarna representative to replace the battery.

5.5 Winter service

Take your product to your local Husqvarna representative for service prior to winter storage. Regular winter service will maintain the product in good condition and create the best conditions for a new season without any disruptions.

Service usually includes the following:

- Thorough cleaning of the body, the chassis, the blade disc and all other moving parts.
- Testing of the products's function and components.
- Checking and, if required, replacing wear items such as blades and bearings.
- Testing the products's battery capacity as well as a recommendation to replace battery if necessary.
- If new firmware is available, the product is updated.

6 Troubleshooting

6.1 Introduction - troubleshooting

In this chapter, a number of messages are listed which may be shown in the display if there is a malfunction. There is a proposal as to the cause and steps to take for each message. This chapter also presents some symptoms that can guide you if the product does not work as expected. More suggestions for steps to take in the event of malfunction or symptoms can be found on www.husqvarna.com.

6.2 Fault messages

The list below shows a number of fault messages that may be shown in the display of the product. Contact your local Husqvarna representative if the same message appears often.

Message	Cause	Action
<i>Wheel motor blocked</i>	Grass or other object is wrapped around the drive wheel.	Check the drive wheel and remove the grass or other object.
<i>Cutting system blocked</i>	Grass or other object is wrapped around the blade disc.	Check the drive wheel and remove the grass or other object.
	The blade disc lies in a pool of water.	Move the product and prevent the collection of water in the work area.
<i>Cutting height blocked</i>	Grass or other object is wrapped around the cutting height adjustment, or between the blade disc and chassis.	Check the blade disc and the bellows around the cutting height adjustment, and remove any grass or other objects that may have got stuck.
<i>Trapped</i>	The product has got caught in something.	Free the product and rectify the reason for it becoming trapped.
	The product is stuck behind a number of obstacles.	Check if there are any obstacles which make it hard for the product to move on from this location.

Message	Cause	Action
<i>No loop signal</i>	The power supply is not connected.	Check the wall socket connection and whether an earth-fault breaker has tripped or not. Check that the low voltage cable is connected to the charging station.
	The low voltage cable is damaged or not connected.	Check that the low voltage cable is not damaged. Check that it is also properly connected to the charging station and to the power supply.
	The boundary wire is not connected to the charging station.	Check that the boundary wire connectors are fitted properly to the charging station. Replace connectors if damaged. Refer to <i>To install the boundary wire on page 21</i> .
	Boundary wire broken.	Find out where the break is. Replace the damaged section of the loop with a new loop wire and splice using an original coupler. Refer to <i>Finding breaks in the loop wire on page 50</i> .
	<i>ECO mode</i> is activated and the product has attempted to start outside the charging station.	Place the product in the charging station and start the product again. Refer to <i>To start the product on page 34</i> .
	The boundary wire is laid in the wrong direction around an island.	Check that the boundary wire was laid according to instructions, e.g. in the right direction around the island. Refer to <i>Before the installation of the product on page 16</i> .
	The connection between the product and the charging station has been broken.	Place the product in the charging station and generate a new loop signal. Refer to <i>To create a New loop signal on page 26</i> .
<i>Wrong PIN code</i>	Disturbances from metal objects (fences, reinforcement steel) or buried cables close by.	Try moving the boundary wire.
	Wrong PIN code has been entered. Five attempts are permitted, and the keypad is then blocked for five minutes.	Enter the correct PIN code. Contact your local Husqvarna representative if you forget the PIN code.

Message	Cause	Action
<i>Outside work area</i>	The boundary wire connections to the charging station are crossed.	Check that the boundary wire is connected correctly.
	The boundary wire is too close to the edge of the work area.	Check that the boundary wire has been laid according to the instructions. Refer to <i>To install the boundary wire on page 21</i> .
	The work area slopes too much by the boundary loop.	
	The boundary wire is laid in the wrong direction around an island.	
	Disturbances from metal objects (fences, reinforcement steel) or buried cables close by.	Try moving the boundary wire.
	The product finds it hard to distinguish the signal from another product installation close by.	Place the product in the charging station and generate a new loop signal. Refer to <i>To create a New loop signal on page 26</i> .
<i>Empty battery</i>	The product cannot find the charging station.	Check that the charging station and the guide wire are installed in accordance with the instructions. Refer to <i>Installation of the product on page 20</i> .
	The guide wire is broken or not connected.	Find out where the break is and rectify it.
	The battery is spent.	Replace the battery. Refer to <i>Battery on page 38</i> .
	The charging station's antenna is defective.	Check if the indicator lamp in the charging station flashes red. Refer to <i>LED indicator lamp on the charging station on page 47</i> .
<i>No drive</i>	The product has got caught in something.	Free the product and rectify the reason for the lack of drive. If it is due to wet grass, wait until the lawn has dried before using the product.
	The work area includes a steep slope.	Maximum guaranteed slope is 45%. Steeper slopes should be isolated. Refer to <i>To put the boundary wire in a slope on page 18</i> .
	The guide wire is not laid at an angle on a slope.	If the guide wire is laid on a slope, it must be laid at an angle across the slope.
<i>Wheel motor overloaded</i>	The product has got caught in something.	Free the product and rectify the reason for the lack of drive. If it is due to wet grass, wait until the lawn has dried before using the product.

Message	Cause	Action
<i>Charging station blocked</i>	The contact between the charging strips and contact strips may be poor and the product has made a number of attempts to charge.	Put the product in the charging station and check that the charging strips and contact strips make good contact.
	An object is obstructing the product.	Remove the object.
	The charging station is tilted or bent.	Confirm that the charging station is placed on a fully flat and horizontal ground. The charging station must not be tilted or bent.
<i>Stuck in charging station</i>	There is an object in the way of the product preventing it from leaving the charging station.	Remove the object.
<i>Upside down</i>	The product is leaning too much or has turned over.	Place the product on a flat, level surface, and start the product again.
<i>Needs manual charging</i>	The product is set to the <i>Secondary area</i> operating mode.	Place the product in the charging station. This behavior is normal and no action is required.
<i>Next start hh:mm</i>	The timer setting prevents the product from operating.	Change the timer settings. Refer to <i>To do the timer settings on page 24</i> .
	The clock on the product is not correct.	Set the time. Refer to <i>To set the time & date on page 31</i> .
<i>Lifted</i>	The lift sensor has been activated as the product has become trapped.	Free the product.
<i>Collision sensor problem, front/rear</i>	The body of the product can not move freely around its chassis.	Check that the body of the product can move freely around its chassis. If the problem remains, the message requires action by an authorized service technician.
<i>Wheel drive problem, right/left</i>	Grass or other object is wrapped around the drive wheel.	Clean the wheels and around the wheels.
<i>Alarm! Mower stopped</i>	The alarm was activated because the product was stopped.	Adjust the mower security settings in the <i>Security</i> menu. Refer to <i>Security level on page 25</i> .
<i>Alarm! Mower lifted</i>	The alarm was activated because the product was lifted.	
<i>Alarm! Mower tilted</i>	The alarm was activated because the product was tilted.	

Message	Cause	Action
<i>Electronic problem</i>	Temporary electronic or firmware related issue in the product.	Switch off/on the product. If the problem remains, the message requires action by an authorized service technician.
<i>Loop sensor problem, front/rear</i>		
<i>Charging system problem</i>		
<i>Tilt sensor problem</i>		
<i>Temporary problem</i>		
<i>Temporary battery problem</i>	Temporary battery or firmware related issue in the product.	Switch off/on the product. If the problem remains, the message requires action by an authorized service technician.
<i>Battery problem</i>		
<i>Charging current too high</i>	Wrong or faulty power supply unit.	Switch off/on the product. If the problem remains, the message requires action by an authorized service technician.
<i>Connectivity problem</i>	Potential problem on the connectivity circuit board in the product.	Switch off/on the product. If the problem remains, the message requires action by an authorized service technician.

6.3 Information messages

The list below shows a number of information messages that may be found in the *Messages* menu in the Automower® Connect app. Contact your local Husqvarna representative if the same message appears often.

Message	Cause	Action
<i>Low battery</i>	The product cannot find the charging station.	Check that the charging station and the guide wire are installed in accordance with the instructions. Refer to <i>Before the installation of the product on page 16</i> .
	The guide wire is broken or not connected.	Find out where the break is and rectify it.
	The battery is spent.	Replace the battery. Refer to <i>Battery on page 38</i> .
	The charging station's antenna is defective.	Check if the indicator lamp in the charging station flashes red. Refer to <i>LED indicator lamp on the charging station on page 47</i> .
<i>Settings restored</i>	Confirmation that a <i>Reset all user settings</i> has been carried out.	This is normal. No action required.
<i>Limited cutting height range</i>	The maximum and minimum position of the cutting height adjustment is limited.	Check that no grass or other objects are blocking the blade disc from moving up or down.
		Carry out a cutting height calibration. Contact your local Husqvarna representative.
<i>Unexpected cutting height adj</i>	The cutting height adjustment is altered without a request from the product.	Carry out a cutting height calibration. Contact your local Husqvarna representative.
<i>Cutting system imbalance</i>	The product has discovered vibrations in the cutting disc.	Verify that the blades and screws are intact and not worn out. Verify that all blades are correctly mounted. Check that no double blades are mounted on any of the three blade positions.

Message	Cause	Action
<i>Guide 1 not found</i> <i>Guide 2 not found</i> <i>Guide 3 not found</i>	The guide wire is not connected to the charging station.	Check that the guide wire's connector is tightly connected to the charging station. Refer to <i>To install the guide wire on page 21</i> .
	Break in the guide wire.	Find out where the break is. Replace the damaged section of the guide wire with a new loop wire and splice using an original coupler.
	The guide wire is not connected to the boundary loop.	Check that the guide wire is connected correctly to the boundary loop. Refer to <i>To install the guide wire on page 21</i> .
<i>Guide calibration failed</i>	The product has failed to calibrate the guide wire.	Check that the guide wires are installed according to the instructions. Refer to <i>To install the guide wire on page 21</i> .
<i>Guide calibration accomplished</i>	The product has succeeded to calibrate the guide wire.	No action required.
<i>GPS navigation problem</i>	Problem with the GPS assisted navigation equipment.	Contact your local Husqvarna representative if this message appears often.
<i>Weak GPS signal</i>	The GPS signal is weak for the current work area. GPS assisted navigation cannot be used.	If the message appears often, disable the GPS assisted navigation and instead use the manual settings for Lawn coverage. Refer to <i>To disable and enable the GPS function on page 27</i> .
<i>Difficult finding home</i>	The product has been following the boundary wire several laps without finding the charging station.	The installation has not been done correctly. Refer to <i>Installation on page 16</i> .
		Wrong corridor width setting on boundary wire. Refer to <i>To set the corridor width on page 29</i> .
		The product was started on a Secondary area with the Main area setting.
<i>Temporary problem with the server.</i>	Please try again.	Contact your local Husqvarna representative if this message appears often.
<i>Connection problems</i>	Problem with the Automower® Connect module	Restart the product. If there still is a connection problem, try to unpair the product (<i>My mowers</i>) and then pair it again. If the problem remains, contact your local Husqvarna representative.
<i>Connection settings restored</i>	Settings for wireless connectivity have been restored due to an error.	Check and revise settings if necessary.

Message	Cause	Action
<i>Weak signal</i>	Weak GPS signal for Automower® Connect module	Make sure that the product is not upside down. If the problem remains, the message requires action by an authorized service technician.
<i>SIM card requires PIN</i>	The SIM card must be unlocked.	Make sure the correct SIM PIN has been entered into the mower's menu (Network > SIM card). Contact your local Husqvarna representative if this message appears often.
<i>SIM card locked</i>	The SIM card must be replaced.	Contact your local Husqvarna representative.
<i>SIM card not found</i>	Automower® Connect requires a SIM card to be inserted in the mower.	Contact your local Husqvarna representative.
<i>GeoFence problem</i>	The GeoFence is not work due to poor (or no) communication with the system.	Contact your local Husqvarna representative.

6.4 LED indicator lamp on the charging station

For a fully functional installation, the indicator lamp in the charging station must emit a solid or flashing green light. If any other color than green is visible, follow the troubleshooting guide below.

There is more help on www.husqvarna.com. If you still need help, please contact your local Husqvarna representative.

Light	Cause	Action
<i>Green solid light</i>	Good signals	No action required
<i>Green flashing light</i>	The signals are good and <i>ECO mode</i> is activated.	No action required. For more information on <i>ECO mode</i> . Refer to <i>ECO mode on page 31</i> .
<i>Blue flashing light</i>	The boundary loop is not connected to the charging station.	Check that the boundary wire connectors are fitted properly to the charging station. Refer to <i>To install the boundary wire on page 21</i> .
	Break in the boundary loop.	Find out where the break is. Replace the damaged section of the loop with a new loop wire and splice using an original coupler.
<i>Red flashing light</i>	Interruption in the charging station's antenna.	Contact your local Husqvarna representative.
<i>Red solid light</i>	Fault in the circuit board or incorrect power supply in the charging station. The fault should be rectified by an authorized service technician.	Contact your local Husqvarna representative.

6.5 LED indicator lamp on the product

There is a LED indicator lamp on top of the product, which shows the current status:

Light	Cause	Action
<i>Green solid light</i>	The product is either mowing the lawn, or leaving the charging station.	No action required.
<i>Blue solid light</i>	The product is either paused, parked, charging or is searching for the charging station.	No action required.
<i>Yellow solid light</i>	The STOP button has been pressed.	Press the START button on top of the product to start it again.
<i>Red solid light</i>	The product has stopped due to an error.	Clear the error by pressing the STOP button, and then activate the product by pressing the START button on top of the product.
<i>Yellow flashing light</i>	The product requests the PIN code.	The PIN code needs to be confirmed before the product can be activated.

There is more help on www.husqvarna.com. If you still need help, please contact your local Husqvarna representative.

6.6 Symptoms

If your product does not work as expected, follow the symptoms guide below.

There is a FAQ (Frequently Asked Questions) on www.husqvarna.com which provides more detailed answers to a number of standard questions. Contact your local Husqvarna representative if you still cannot find the reason for the fault.

Symptoms	Cause	Action
The product has difficulty docking.	The boundary wire is not laid in a long straight line that is far enough out from the charging station.	Check that the charging station has been installed correctly. Refer to <i>To install the charging station on page 20</i>
	The charging station is on a slope.	Place the charging station on a surface that is entirely level. Refer to <i>To examine where to put the charging station on page 16</i> .
The product runs at the wrong time	The product clock needs to be set.	Set the clock. Refer to <i>To set the time & date on page 31</i> .
	The start and stop times for mowing are incorrect.	Reset the start time and stop time settings for mowing. Refer to <i>To reset the timer setting on page 25</i> .
The product vibrates.	Damaged blades lead to imbalance in the cutting system.	Inspect the blades and screws and replace them if necessary. Refer to <i>Replace the blades on page 38</i> .
	Too many blades in the same position lead to imbalance in the cutting system.	Check that only one blade is fitted at each screw.
	Different versions (thickness) of Husqvarna blades are used.	Check if the blades are of different versions.
The product runs, but the blade disc does not rotate.	The product searches for the charging station.	No action. The blade disc does not rotate when the product is searching for the charging station.
The product mows for shorter periods than usual between charges.	Grass or other foreign object blocks the blade disc.	Remove and clean the blade disc. Refer to <i>Chassis and blade disc on page 37</i> .
	The battery is spent.	Replace the battery. Refer to <i>To remove the battery on page 53</i> .
Both the mowing and charging times are shorter than usual.	The battery is spent.	Replace the battery. Refer to <i>To remove the battery on page 53</i> .
The product is parked for hours in the charging station.	The product is parked due to a timer setting, or because <i>Park until further notice</i> has been chosen in the app.	Edit the timer settings or press the START button to start the product.

Symptoms	Cause	Action
The product often moves in circles or spirals.	Spiral cutting is a natural part of the product's movement pattern.	Adjust the intensity of spiral cutting. This function can be disabled if necessary. Refer to <i>Spiral Cutting on page 31</i> .
The product turns round and stays on a small area for several minutes.	This is completely normal for the product. The product has GPS assisted navigation that contributes to an even result.	No action.
Uneven mowing results.	The product works too few hours per day.	Increase the mowing time. Refer to <i>To do the timer settings on page 24</i> . The <i>Weather timer</i> senses that the lawn has been mowed more than it actually has. Increase the intensity level in the <i>Weather timer</i> . Disable the <i>Weather timer</i> if this does not help.
	The <i>How often?</i> setting is incorrect in relation to the layout of the work area. Note: Not applicable if GPS assisted navigation is enabled.	Check that the correct <i>How often?</i> value is selected.
	The shape of the work area requires the use of <i>Area 1-5</i> for the product to find its way to all remote areas. Note: Not applicable if GPS assisted navigation is enabled.	Use <i>Area 1-5</i> to steer the product to a remote area. Refer to <i>Lawn coverage on page 27</i> .
	Work area is too large.	Try to limit the work area, or to extend the work time. Refer to <i>To do the timer settings on page 24</i> .
	Dull blades.	Replace all the blades. Refer to <i>Replace the blades on page 38</i> .
	Long grass in relation to the set cutting height.	Increase the cutting height and then successively lower it.
	Accumulation of grass by the blade disc or around the motor shaft.	Check that the blade disc rotates freely and easily. If not, screw off the blade disc and remove grass and foreign objects. Refer to <i>Clean the product on page 37</i> .

6.7 Finding breaks in the loop wire

Breaks in the loop wire are usually the result of unintentional physical damage to the wire such as when gardening with a shovel. In countries with ground frost, also sharp stones that move in the ground can damage the wire. Breaks can also occur due to the wire being stretched excessively during installation.

Mowing the grass too low right after the installation can damage wire insulation. Damage to the insulation may not cause disruptions until several weeks or months later.



CAUTION: Always select the maximum cutting height the first weeks after installation and then lower the height one step at a time every second week until the desired cutting height has been reached.

A defective splicing of the loop wire can also lead to disruptions several weeks after the splice was done. A faulty splice can, for example, be the result of the original coupler not being pressed together hard enough with a pair of pliers, or that a coupler of lower quality than the original coupler has been used.

Note: Please first check all known splices before further troubleshooting is done.

A wire break can be located by gradually halving the distance of the loop where the break may have occurred until there is only a very short section of the wire left.

The following method does not work if *ECO mode* is activated. Make sure first that *ECO mode* is turned off. Refer to *ECO mode* on page 31.

1. Check that the indicator lamp in the charging station flashes blue, which indicates a break in the boundary loop. Refer to *LED indicator lamp on the charging station* on page 47.
2. Check that the boundary wire connections to the charging station are properly connected and not damaged. Check that the indicator lamp in the charging station is still flashing blue.

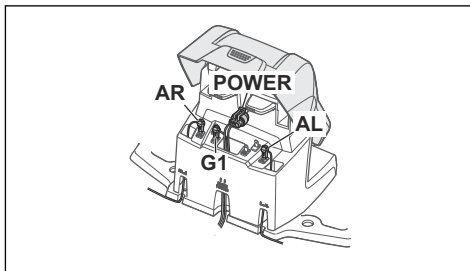

3. Switch the connections between the guide wire and the boundary wire in the charging station.

Start by switching connection AL and G1. Some models have additional guide wires (G2, G3). The same procedure can be followed for them.

If the indicator lamp is lit with a solid green light, then the break is somewhere on the boundary wire between AL and the point where the guide wire is connected to the boundary wire (thick black line in the illustration).

To rectify the fault you will need boundary wire, connector(s) and coupler(s):

- a) If the suspected boundary wire is short then it is easiest to exchange all of the boundary wire between AL and the point where the guide wire is connected to the boundary wire (thick black line).
- b) If the suspected boundary wire is long (thick black line) then do as follows: Put AL and G1 back to their original positions. Then disconnect AR. Connect a new loop wire to AR. Connect the other end of this new loop wire at the middle of the suspected wire section.

If the indicator lamp now is green, then the break is somewhere in the wire between the disconnected end to the point where the new wire is connected (thick black line below). In that case, move the connection for the new wire closer to the disconnected end (roughly at the middle of the suspected wire section) and check again if the indicator lamp is green.

Continue until only a very short section of the wire remains which is the difference between a solid green light and a flashing blue light. Then follow instruction in step 5 below.

4. If indicator lamp still flashes blue in step 3 above: Put AL and G1 back in their original positions. Then switch AR and G1. If indicator lamp now is lit with a solid green light then disconnect AL and connect a new boundary wire to AL. Connect the other end of this new wire at the middle of the suspected wire section. Follow the same approach as in 3a) and 3b) above.

- When the break is found, the damaged section must be replaced with a new wire. Always use original couplers.

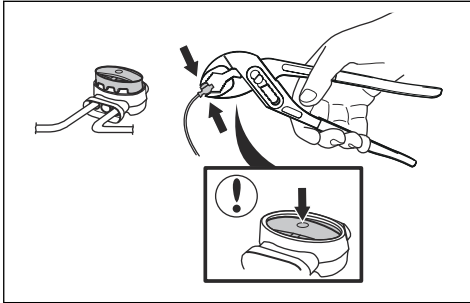

7 Transportation, storage and disposal

7.1 Transportation

The supplied Li-ion batteries obey the Dangerous Goods Legislation requirements.

- Obey all applicable national regulations.
- Obey the special requirement on package and labels for commercial transportations, including by third parties and forwarding agents.

7.2 Storage

- Fully charge the product. Refer to *To charge the battery on page 35*.
- Disconnect the product with the **main switch**. Refer to *To switch off the product on page 35*.
- Clean the product. Refer to *Clean the product on page 37*.
- Keep the product in a dry, frost free space.
- Keep the product with all wheels on level ground during storage, or use a Husqvarna wall hanger.
- If you keep the charging station indoors, disconnect and remove the power supply and all the connectors from the charging station. Put the end of each connector wire in a container with grease.

Note: If you keep the charging station outdoors, do not disconnect the power supply and the connectors.

7.3 Disposal

- Obey the local recycling requirements and applicable regulations.
- For questions about how to remove the battery, refer to *To remove the battery on page 53*.

7.3.1 To remove the battery



CAUTION: Only remove the battery when you dispose the product. When you remove the warranty seal, the Husqvarna warranty is no longer applicable.

1. Switch off the product. Refer to *Main switch on page 34*.
2. Pull out the grommet on the charging cable at the very front of the product, and carefully remove the connector.
3. Lift the cover, one corner at a time.
4. Remove the 14 screws with a Torx 20.

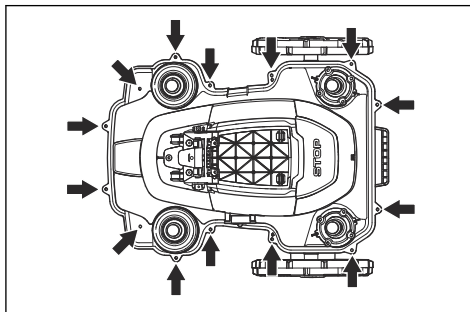

5. Lift the rear edge of the top section of the chassis.
6. Disconnect the cable from the main circuit board.
7. Remove the top section of the chassis.
8. Remove the 3 screws that holds the battery with a Torx 20.

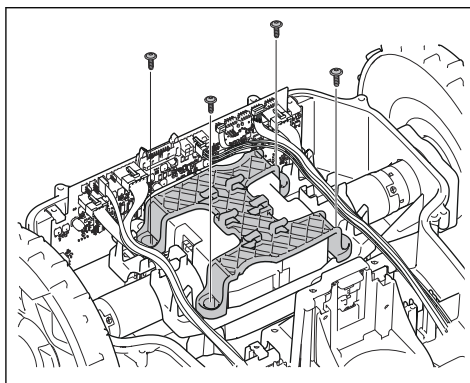

9. Disconnect the battery connection from the main circuit board.
10. Open the battery cover and remove the battery.

8 Technical data

8.1 Technical data

Dimensions	Automower® 430XH	Automower® 450XH
Length, cm / "	75 / 29.5	75 / 29.5
Width, cm / "	63 / 24.8	63 / 24.8
Height, cm / "	33 / 13	33 / 13
Weight, kg / lbs	14.7 / 5.8	15.3 / 6

Electrical system	Automower® 430XH	Automower® 450XH
Battery, Lithium-Ion 18 V/5.2 Ah Art. No.	588 14 64-01	588 14 64-01
Battery, Lithium-Ion 18 V/5.0 Ah Art. No.	593 11 84-01	593 11 84-01 (2 pcs.) 5.0 Ah/ battery
Battery, Lithium-Ion 18 V/4.9 Ah Art. No.	593 11 84-02	593 11 84-02 (2 pcs.) 4.9 Ah/ battery
Power supply, V/28 V DC	100-240	100-240
Low voltage cable length, m / ft	10 / 33	10 / 33
Mean energy consumption at maximum use	18 kWh/month for a work area of 3200 m ² / 0.8 acre	23 kWh/month for a work area of 5000 m ² / 1.25 acres
Charging current, A DC	4.2	7
Average mowing time, min	145	270
Average charging time, min	50	60

Boundary wire antenna	Automower® 430XH	Automower® 450XH
Operating Frequency Band, Hz	300-80000	300-80000
Maximum Radio-frequency power, mW @60m ⁵	<25	<25

⁵ Maximum active output power to antennas in the frequency band in which the radio equipment operates.

Noise emissions measured in the environment as sound power⁶	Automower® 430XH	Automower® 450XH
Measured sound power noise level, dB (A)	56	60
Guaranteed sound power noise level	59	62
Sound pressure noise level at the operator's ear, dB (A) ⁷	45	49

Mowing	Automower® 430XH	Automower® 450XH
Cutting system	3 pivoted cutting blades	
Blade motor speed, rpm	2300	2300
Power consumption during cutting, W +/- 20 %	30	35
Cutting height, cm / "	5-9 / 2-3.6	5-9 / 2-3.6
Cutting width, cm / "	24 / 9.4	24 / 9.4
Narrowest possible passage, cm / "	60 / 24	60 / 24
Maximum angle for work area, %	45	45
Maximum angle for boundary wire, %	15	15
Maximum length boundary wire, m / ft	800 / 2600	800 / 2600
Maximum length guide loop, m / ft	400 / 1300	400 / 1300
Working capacity, m ² / acre(s), +/- 20%	3200 / 0.8	5000 / 1.25

IP-classification	Automower® 430XH	Automower® 450XH
Robotic lawn mower	IPX4	IPX4
Charging station	IPX1	IPX1
Power supply	IPX4	IPX4

⁶ Noise emissions in the environment measured as sound power (L_{wa}) in conformity with EC directive 2000/14/EC and New South Wales legislation (Protection of the Environment Operations Regulation 2017, Noise Control). The guaranteed sound power level includes variation in production as well as variation from the test code with 1-3 dB(A). Noise emission data can be found on the rating label and in the Technical data chapter.

⁷ Sound pressure noise uncertainties K_{pA} , 2-4 dB (A)

Frequency Band Support	
Automower® Connect 3G	Band 19 (800 MHz)
	Band 5 (850 MHz)
	Band 8 (900 MHz)
	Band 2 (1900 MHz)
	Band 1 (2100 MHz)
Automower® Connect 2G	GSM 850 MHz
	E-GSM 900 MHz
	DCS 1800 MHz
	PCS 1900 MHz

Power Class		
Automower® Connect 3G	Power Class 3	24 dBm
Automower® Connect 2G	Power Class 4 (for GSM/E-GSM)	33 dBm
	Power Class 1 (for DCS/PCS)	30 dBm

Husqvarna AB does not guarantee full compatibility between the product and other types of wireless systems such as remote controls, radio transmitters, hearing loops, underground electric animal fencing or similar.

The products are made in England or the Czech Republic. See information on the rating plate. Refer to *Introduction on page 3*

9 Warranty

9.1 Warranty terms

Husqvarna® warranty covers this product's functionality for a period of 2 years from date of purchase. The warranty covers serious faults relating to materials or manufacturing faults.

Within the warranty period, we will replace the product or repair it at no charge if the following terms are met:

- The product and the charging station may only be used in compliance with the instructions in this Operator's Manual. This manufacturer's warranty does not affect warranty entitlements against the dealer/retailer.
- End-users or non-authorized third parties must not attempt to repair the product.

Examples of faults which are not included in the warranty:

- Damage caused by water seepage from using a high-pressure washer, or from being submerged under water, for example when heavy rain forms pools of water.
- Damage caused by lightning.
- Damage caused by improper battery storage or battery handling.
- Damage caused by using a battery that is not a Husqvarna original battery.
- Damage caused by not using Husqvarna original spare parts and accessories, such as blades and installation material.
- Damage to the loop wire.
- Damage caused by non-authorized changing or tampering with the product or its power supply.

The blades and wheels are seen as disposable and are not covered by the warranty.

If an error occurs with your Husqvarna product, please contact Husqvarna customer service for further instructions. Please have the receipt and the product's serial number at hand when contacting Husqvarna customer service.

10 Applicable to US/CA market

10.1 Supplier's Declaration of Conformity

Issuer: Husqvarna AB, Drottningatan 2, S-561 82 Huskvarna, Sweden
www.husqvarnagroup.com.

Responsible party: Husqvarna Professional Products, Inc. 9335 Harris Corners Parkway Suite 500 Charlotte, NC 28269 United States U.S. Contact information: James McNew, Manager Product Compliance, Telephone: +1 704 597 5000.

10.2 Compliance requirements

FCC ID: XPY1CGM5NNN (Automower® Connect module).

The device complies with part 15 of the FCC Rules. Operation is subjected to the following 2 conditions:

1. This device may not cause harmful interference.
2. This device must accept any interference received, including interference that may cause undesired operation.



WARNING: To comply with RF exposure requirements, please maintain a separation distance of at least 20 cm / 7 inches from any part of the product.

Models with a hatch: The supplied label shall be attached to the product according to figure below.

This device contains the module
FCC ID: XXX1YYYY2ZZZ

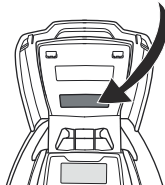

Note: Changes or modifications made to this equipment not expressly approved by Husqvarna

may void the FCC authorization to operate this equipment.

Note: This device complies with Part 15 of the FCC Rules [and with Industry Canada licenceexempt RSS standard(s)]. Operation is subject to the following two conditions: this device may not cause harmful interference, and this device must accept any interference received, including interference that may cause undesired operation.

Note: This equipment has been tested and found to comply with the limits for a Class B digital device, pursuant to part 15 of the FCC Rules. These limits are designed to provide reasonable protection against harmful interference in a residential installation. This equipment generates, uses and can radiate radio frequency energy and, if not installed and used in accordance with the instructions, may cause harmful interference to radio communications. However, there is no guarantee that interference will not occur in a particular installation. If this equipment does cause harmful interference to radio or television reception, which can be determined by turning the equipment off and on, the user is encouraged to try to correct the interference by one or more of the following measures:

- Reorient or relocate the receiving antenna.
- Increase the separation between the equipment and receiver.
- Connect the equipment into an outlet on a circuit different from that to which the receiver is connected.
- Consult the dealer or an experienced radio/TV technician for help.



WARNING: Cancer and Reproductive Harm - www.P65Warnings.ca.gov



Husqvarna[®]

AUTOMOWER[®] is a trademark owned by Husqvarna AB.
Copyright[®] 2019 HUSQVARNA. All rights reserved.

www.husqvarna.com

Original instructions

1141532-95



2019-07-05