



Operator's manual
HUSQVARNA AUTOMOWER®
550 EPOS



EN, English

Read the operator's manual carefully and make sure that you understand the instructions before you use the product.

Contents

1 Introduction	
1.1 Support.....	3
1.2 System description.....	3
1.3 Product description.....	3
1.4 System overview.....	4
1.5 Product overview.....	5
1.6 Symbols on the product.....	5
1.7 Symbols on the battery.....	6
1.8 Symbols in the Automower® Connect app.....	6
1.9 General manual instructions.....	6
2 Safety	
2.1 Safety information.....	8
2.2 Safety definitions.....	9
2.3 Safety instructions for operation.....	9
3 Installation	
3.1 Introduction - Installation.....	12
3.2 Primary components for installation.....	12
3.3 General preparations.....	12
3.4 To examine where to put the reference station...	12
3.5 To examine where to put the charging station....	12
3.6 To examine where to put the power supply.....	13
3.7 To examine where to install the objects on the map.....	14
3.8 Installation of the product.....	15
3.9 Settings in Automower® Connect.....	20
4 Operation	
4.1 Main switch.....	23
4.2 To start the product.....	23
4.3 Operating mode - Start.....	23
4.4 Operating mode - Park.....	23
4.5 To stop the product.....	24
4.6 To switch off the product.....	24
4.7 To charge the battery.....	24
5 Maintenance	
5.1 Introduction - maintenance.....	25
5.2 Clean the product.....	25
5.3 Replace the blades.....	26
5.4 Battery.....	26
5.5 Winter service.....	26
6 Troubleshooting	
6.1 Introduction - troubleshooting.....	27
6.2 Fault messages.....	27
6.3 Information and warning messages.....	33
6.4 LED indicator lamp on the charging station.....	34
6.5 LED indicator lamp on the product.....	34
6.6 Symptoms.....	35
7 Transportation, storage and disposal	
7.1 Transportation.....	37
7.2 Storage.....	37
7.3 Disposal.....	37
8 Technical data	
8.1 Technical data.....	38
8.2 Registered trademarks.....	40
9 Warranty	
9.1 Warranty terms.....	41
10 Applicable to US/CA market	
10.1 Supplier's Declaration of Conformity.....	42
10.2 Compliance requirements.....	42

1 Introduction

Serial number:

PIN code:

The serial number is on the product rating plate and on the product carton.

1.1 Support

For support about the product, speak to your Husqvarna servicing dealer.

1.2 System description

The EPOS system contains a robotic lawn mower, a charging station and a reference station. The robotic lawn mower and the reference station receive satellite signals for positioning. The reference station is stationary and sends correction data to the robotic lawn mower to get an accurate position of the robotic lawn mower. The work area for the product is made virtually in Automower® Connect app by operating the product and adding waypoints to make a map in the app. Refer to *System overview on page 4*.

1.3 Product description

Note: Husqvarna regularly updates the appearance and function of the products. Refer to *Support on page 3*.

The product is a robotic lawn mower. The product has a battery power source and cuts grass automatically. It continuously alternates between mowing and charging. The movement pattern is random, which means that the lawn is mowed evenly and with less wear. The virtual boundary specifies the work area where the product is allowed to operate. The satellite receiver in the product senses when it is approaching the virtual boundary. When the product hits an obstacle or approaches the virtual boundary the product selects a new direction.

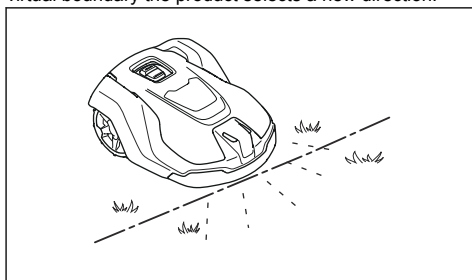

The operator selects the operation settings in the Automower® Connect app. The app shows the selected and possible operation settings, and the operation mode of the product.

1.3.1 Mowing technique

The product is emission free, easy to use and saves energy. The frequent cutting technique improves the grass quality and decreases the use of fertilizers. Collection of grass is not necessary.

1.3.2 Find the charging station

The product operates until the battery state of charge is low, then the product starts to find its way to the charging station. The product uses EPOS guidance to find the charging station. EPOS guidance uses satellite signals to find a path to the charging station that reduces the wear on the lawn.

1.3.3 Connectivity

Automower® Connect is a mobile application that is used for the installation of the product and makes it possible to select the operation settings remotely. Refer to *Automower® Connect on page 16*.

Husqvarna Fleet Services™ is a cloud solution where multiple products can be added to get an overview of all products and control them remotely. Husqvarna Fleet Services™ is available as a web service and as an app. Refer to *Husqvarna Fleet Services™ on page 16*.

1.4 System overview

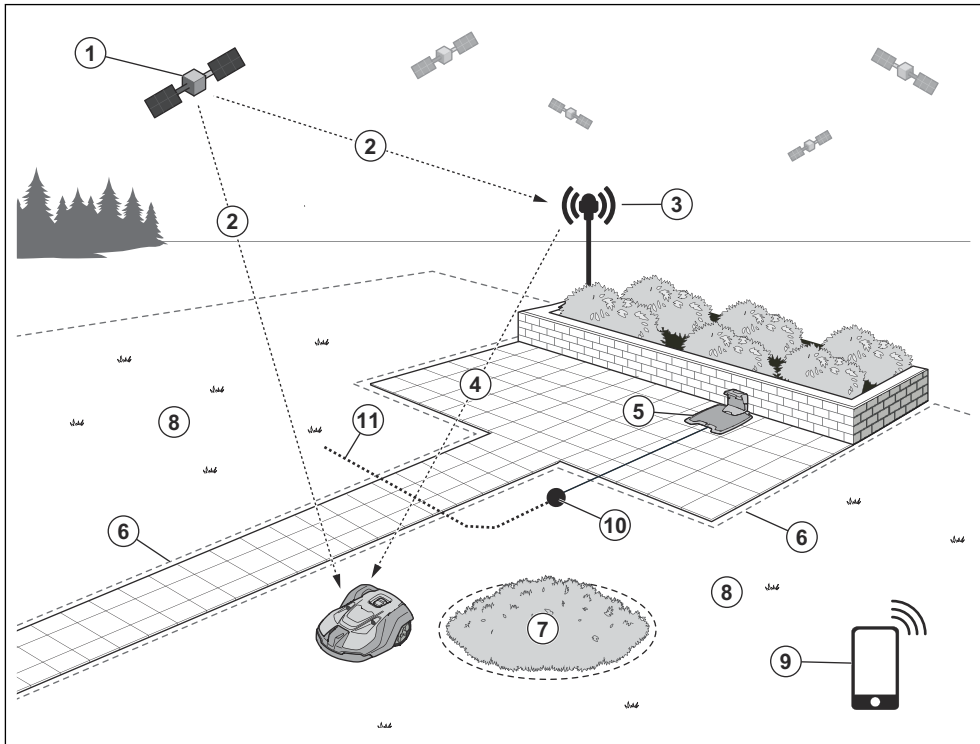

- | | |
|-----------------------------------|-------------------------------|
| 1. Navigation satellites | 7. Stay-out zone |
| 2. Satellite signals | 8. Work area |
| 3. Reference station ¹ | 9. Mobile device ² |
| 4. Correction data | 10. Docking point |
| 5. Charging station | 11. Transport path |
| 6. Virtual boundary | |

¹ Purchased separately.

² Not included.

1.5 Product overview

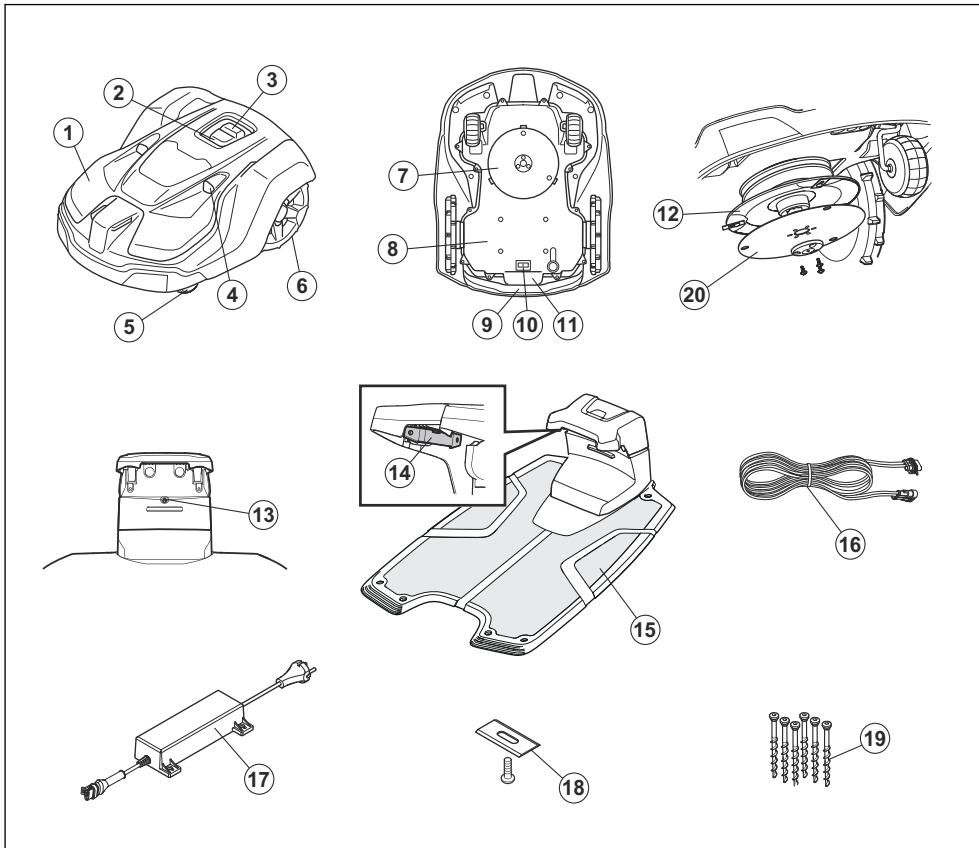

1. Body
2. LED indicator lamp of the product
3. STOP/START button
4. Ultrasonic sensors
5. Front wheels
6. Rear wheels
7. Cutting system
8. Chassis box with electronics, battery and motors
9. Handle
10. Main switch
11. Rating plate (including product identification code)
12. Blade disc
13. LED indicator lamp of the charging station
14. Contact strips
15. Charging station
16. Low-voltage cable
17. Power supply³
18. Extra blades
19. Screws for securing the charging station

1.6 Symbols on the product

These symbols can be found on the product. Study them carefully.

³ The appearance may differ depending on market.



WARNING: Read the user instructions before operating the product.



WARNING: Disable the product before working on or lifting the product.



WARNING: Keep a safe distance from the product when operating. Keep your hands and feet away from the rotating blades.



WARNING: Do not ride on the product. Never put your hands or feet close to or under the product.

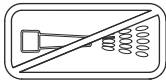

Never use a high-pressure washer or even running water to clean the product.

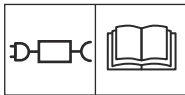

Use a detachable power supply as defined on the rating label next to the symbol.



This product conforms to the applicable EC Directives.



It is not permitted to dispose this product as normal household waste. Ensure that the product is recycled in accordance with local legal requirements.



The chassis contains components which are sensitive to electrostatic discharge (ESD). The chassis must also be resealed in a professional manner. For these reasons the chassis shall only be opened by authorized service technicians. A broken seal can result in the entire or parts of the warranty no longer being valid.



The low-voltage cable must not be shortened, extended or spliced.

Do not use a trimmer nearby the low-voltage cable. Be careful when trimming edges where the cables are placed.

1.7 Symbols on the battery



Read the user instructions.



Do not discard the battery into fire and do not expose the battery to a heat source.



Do not immerse the battery into water.

1.8 Symbols in the Automower® Connect app



Shows the strength of the radio signal that the product receives from the reference station.

The status is EPOS confirmed. The product has an accurate position and direction. This is necessary to operate the product automatically and for the installation of map objects.



The status is EPOS action is necessary. The product has an accurate position but it is necessary to operate the product, manually or automatically, to get an accurate direction.



The status is EPOS searching. The product does not have an accurate position and is searching for the satellite signals and the correction data to get an accurate position.



1.9 General manual instructions

The following system is used in the Operator's Manual to make it easier to use:

- Text written in *italics* is a text that is in the Automower® Connect app, or is a reference to another section in the Operator's manual.
- Text written in **bold** is one of the buttons on the product or in appDrive.

2.1 Safety information

2.1.1 IMPORTANT. READ CAREFULLY BEFORE USE. KEEP FOR FUTURE REFERENCE

The operator is responsible for accidents or hazards occurring to other people or property.

This appliance is not intended for use by persons (including children) with reduced physical, sensory or mental capabilities (that could affect a safe handling of the product), or lack of experience and knowledge, unless they have been given supervision or instruction concerning use of the appliance by a person responsible for their safety.

This appliance can be used by children aged from 8 years and above and persons with reduced physical, sensory or mental capabilities or lack of experience and knowledge if they have been given supervision or instruction concerning use of the appliance in a safe way and understand the hazards involved. Local regulations may restrict the age of the operator. Cleaning and maintenance shall not be made by children without supervision.

Never connect the power supply to an outlet if the plug or cord is damaged. Worn or damaged cord increase the risk of electric shock.

Only charge the battery in the included charging station. Incorrect use may result in electric shock, overheating or leaking of corrosive liquid from the battery. In the event of leakage of electrolyte, flush with water/neutralizing agent. Seek medical help if it comes in contact with the eyes.

Use only original batteries recommended by the manufacturer. Product safety cannot be guaranteed with other than original batteries. Do not use non-rechargeable batteries.

The appliance must be disconnected from the supply mains when removing the battery.



WARNING: The product can be dangerous if used incorrectly.



CAUTION: Used if there is a risk of damage to the product, other materials or the adjacent area if the instructions in the manual are not obeyed.



WARNING: Do not use the product when persons, especially children, or animals are in the work area.

Note: Used to give more information that is necessary in a given situation.



WARNING: Keep your hands and feet away from the rotating blades. Never put your hands or feet close to or under the product when it is switched on.

2.3 Safety instructions for operation

2.3.1 Use

- The product may only be used with the equipment recommended by the manufacturer. All other types of use are incorrect. The manufacturer's instructions with regard to operation/maintenance must be followed precisely.
- The product may only be operated, maintained and repaired by persons that are fully conversant with its special characteristics and safety regulations. Please read the Operator's Manual carefully and make sure you understand the instructions before using the product.
- It is not permitted to modify the original design of the product. All modifications are made at your own risk.
- To prevent damage to the product and accidents to vehicles and persons, do not install work areas and transport paths across public pathways.
- Warning signs shall be placed around the work area of the product if it is used in public areas. The signs shall have the following text: **Warning! Automatic lawn mower! Keep away from the machine! Supervise children!**



WARNING: In the event of an injury or accident seek medical help.

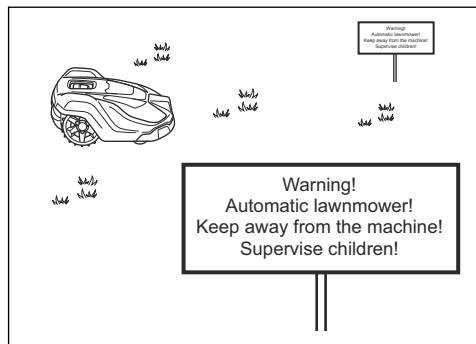

2.2 Safety definitions

Warnings, cautions and notes are used to point out specially important parts of the manual.



WARNING: Used if there is a risk of injury or death for the operator or bystanders if the instructions in the manual are not obeyed.

- Use the park mode, refer to *Park until further notice on page 23* or switch off the product when persons, especially children or animals are in the

work area. Refer to *To switch off the product on page 24*. It is recommended to program the product for use during hours when the area is free from activity. Consider that certain species, e.g. hedgehogs, are active at night. They can potentially be harmed by the product. Refer to *Schedule on page 20*.

- Do not install the charging station, including any accessory, at a location that is below, or within 60 cm / 24 in. from, any combustible material. Do not install the power supply unit in easily flammable surroundings. In case of malfunction, heating of the charging station and the power supply may occur and create a potential risk of fire.
- Check that there are no foreign objects such as stones, branches, tools or toys on the lawn. If the blades hit foreign objects the blades can be damaged. Always switch off the product before clearing a blockage. Inspect the product for damage before starting the product again. Refer to *To switch off the product on page 24*.

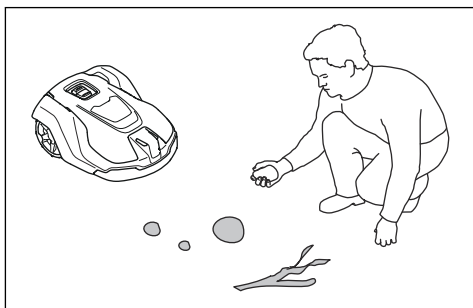

- If the product starts to vibrate abnormally. Always switch off the product and inspect for damage before starting the product again. Refer to *To switch off the product on page 24*.
- Switch on the product according to the instructions. When the product is switched on; make sure to keep your hands and feet away from the rotating blades. Never put your hands and feet under the product.
- Never touch moving hazardous parts, such as the blade disc, before it has come to a complete stop.
- Never lift up the product or carry it around when it is switched on.
- Avoid to let the product collide with persons or other living creatures. If a person or other living creature comes in the way of the product, it shall be stopped immediately. Refer to *To stop the product on page 24*.
- Do not put anything on top of the product, the charging station or the reference station.
- Do not allow the product to be used with a defective guard, blade disc or body. Neither should it be used with defective blades, screws, nuts or

cables. Never connect a damaged cable, or touch a damaged cable before it is disconnected from the supply.

- Do not use the product if the **STOP** button does not work.
- Always switch off the product when it is not in use. The product can only start when the correct PIN code has been entered.
- Do not run when operating the product manually with appDrive. Always walk, be sure on footing on slopes and make sure to maintain balance at all times.
- The product must never be used at the same time as a sprinkler. Use the *Schedule* function so the product and sprinkler never run simultaneously. Refer to *Schedule on page 20*.
- Husqvarna does not guarantee full compatibility between the product and other types of wireless systems such as remote controls, radio transmitters or similar.
- The built-in alarm is very loud. Be careful, especially if the product is handled indoors.
- Operation and storage temperature is 0-50 °C / 32-122 °F. Temperature range for charging is 0-45 °C / 32-113 °F. Too high temperatures might cause damage to the product.

2.3.2 Battery safety



WARNING: Lithium-ion batteries can explode or cause fire if disassembled, short-circuited, exposed to water, fire, or high temperatures. Handle carefully, do not dismantle, open the battery or use any type of electrical/mechanical abuse. Avoid storage in direct sunlight.

For more information about the battery, refer to *Technical data on page 38*

2.3.3 How to lift and move the product

To safely move the product from or in the work area the product can be lifted or operated with appDrive. Refer to *How to lift the product on page 11* and *appDrive on page 23*.



WARNING: The product must be switched off before lifting it. The product is disabled when the **Main switch** is in position 0.



CAUTION: Do not lift the product when it is parked in the charging station. It can damage the charging station and/or the product. Push **STOP** and pull the product out of the charging station before lifting it.

2.3.3.1 How to lift the product

1. Push the **STOP** button to stop the product.

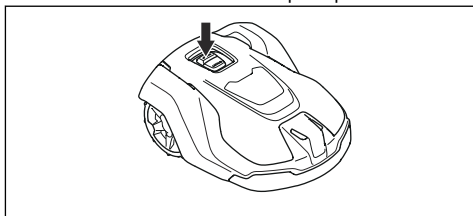

2. Set the **Main switch** in position *0*.

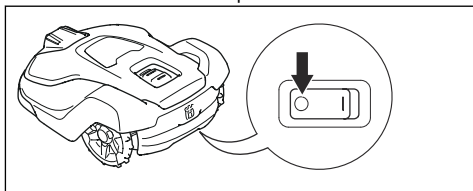

3. Carry the product by the handle with the blade disc away from your body.

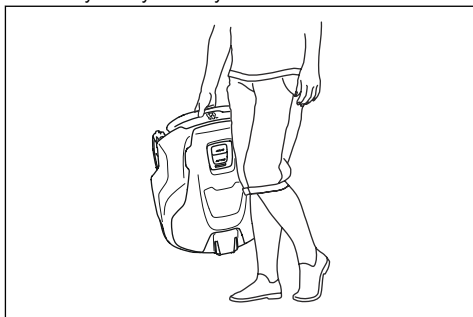

2.3.4 Maintenance



WARNING: When the product is turned upside down the **Main switch** must always be in the *0* position.

The **Main switch** should be set in the *0* position before all work on the chassis of the product, such as cleaning or replacing the blades.

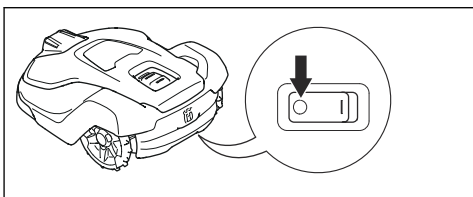

CAUTION: Never use a high-pressure washer or even running water to clean the product, charging station and reference station. Never use solvents for cleaning.



CAUTION: Use the plug to disconnect the charging station before any cleaning or maintenance of the charging station.

Inspect the product each week and replace any damaged or worn parts. Refer to *Maintenance on page 25*.

2.3.5 In the event of a thunderstorm

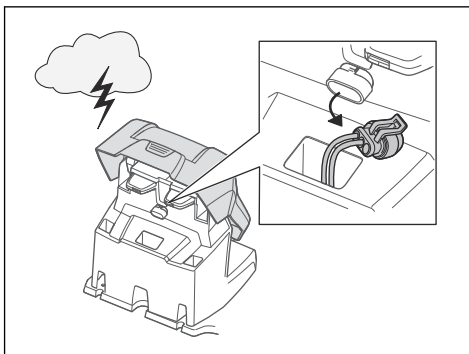

To decrease the risk of damage to electrical components in the product and the charging station, we recommend that the power supplies to the charging station and reference station are disconnected if there is a risk of a thunderstorm. Connect the power supplies again when there is not a risk of thunderstorm.

3 Installation

3.1 Introduction - Installation



WARNING: Read and understand the safety chapter before you install the product.



CAUTION: Use original spare parts and installation material.

Note: Refer to www.husqvarna.com for more information about installation.

3.2 Primary components for installation

The installation includes the components that follow:

- Robotic lawn mower, that cuts the lawn automatically.
- Charging station, that charges the product.
- Power supply, which is connected to the charging station and a 100-240V power outlet.
- Reference station⁴, that receives satellite signals and sends correction data to the robotic lawn mower.
- Mobile device with the Automower® Connect app to do the installation and the settings for the product.

3.3 General preparations



CAUTION: Water filled holes in the lawn can cause damage to the product.



CAUTION: Read the installation chapter before you start the installation.

- Make a blueprint of the work area and include all obstacles. This makes it easier to examine where to put the charging station, the reference station, and the virtual boundaries.
- Make a mark on the blueprint where to put the charging station, the reference station, the point of interest, the transport paths and the virtual boundaries for the work areas and stay-out zones.
- Make sure that the work area where the product operates has unimpeded sky view.
- Fill in holes in the lawn.

⁴ Purchased separately.

- Cut the grass before you install the product. Make sure that the grass is maximum 10 cm / 4 in.

Note: The first weeks after installation the sound level when cutting the grass can be higher than usual. The sound level will decrease when the product has operated for some time.

3.4 To examine where to put the reference station

Read and understand the instructions about where to put the reference station. Refer to the Operator's manual for the reference station.

3.5 To examine where to put the charging station

- Put the charging station in the work area or near the work area. A work area can be connected to the charging station with a transport path.
- You can put the charging station in an Automower® house.
- Keep a minimum 3 m / 10 ft. of free space in front of the charging station.
- Put the charging station (A) where the docking point (B) has unimpeded sky view. This means that 110° of the sky in all directions must be unimpeded. The product cannot receive satellite signals that is less than 10% elevation angle. The charging station docking point (B) is 3 m / 9.8 ft. in front of the charging station.

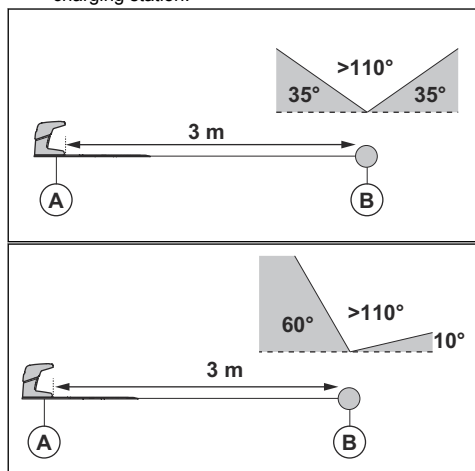

- If the product must not operate in a part of the docking area, put a protective wall that is minimum 15 cm / 6 in. in height. The docking area (A) is a circular area around the charging station with a radius of 3 m / 9.8 ft.

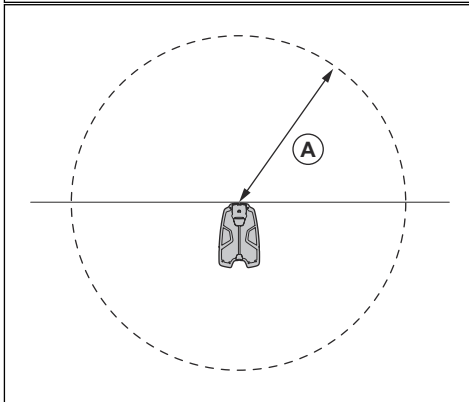
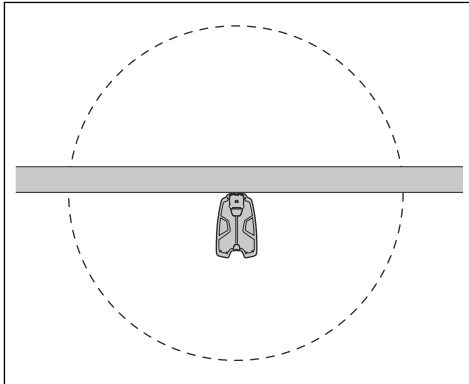

Note: The product uses the charging station signal to search for the charging station when it is in the docking area.

- Put the charging station near a power outlet.
- Put the charging station on a level surface.
- The baseplate of the charging station must not be bent.

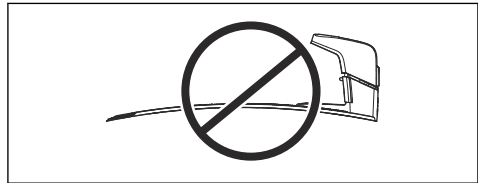
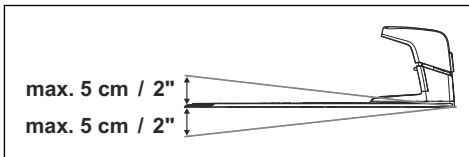

- If the work area has 2 parts separated with a steep slope, we recommend to put the charging station in the lower section.



CAUTION: Metal objects in the ground, for example reinforced concrete or anti-mole nets can cause interference with the charging station signal.

3.6 To examine where to put the power supply



WARNING: Do not cut or extend the low-voltage cable. There is a risk of electrical shock.



CAUTION: Make sure that the blades on the product do not cut the low-voltage cable.



CAUTION: Do not put the low-voltage cable in a coil or below the charging station plate. The coil causes interference with the signal from the charging station.



- Put the power supply in an area with a roof and protection from the sun and rain.
- Put the power supply in an area with good airflow.
- Use a residual-current device (RCD) with a tripping current of maximum 30 mA when you connect the power supply to the power outlet.

Low-voltage cables of different lengths are available as accessories.

3.7 To examine where to install the objects on the map



CAUTION: If the work area is adjacent to water bodies, slopes, precipices or a public road, the virtual boundary must have a protective wall. The wall must be minimum 15 cm / 6 in. in height.



CAUTION: Do not let the product operate on gravel.



CAUTION: For careful operation without noise, isolate all obstacles such as trees, roots and stones.

Note: Make a blueprint of the work area before you install the virtual boundaries.

- Make sure that the area where the product operates has unimpeded sky view. This means that 110° of the sky in all directions must be unimpeded. The product cannot receive satellite signals that is less than 10% elevation angle.

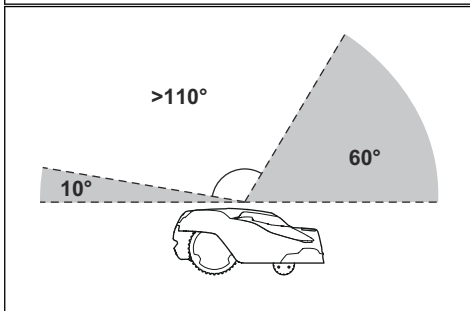
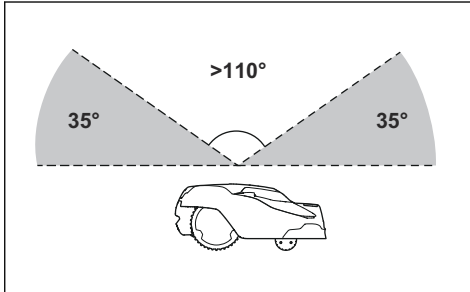

- Make sure that there are no trees close to the virtual boundaries and along the paths.

- Make sure that there are no trees with thick vegetation in the areas where the product operates.
- Make sure the that product can receive radio signals from the reference station in the complete area. It is recommended to have a free line of sight between the product and the reference station for an optimal performance.

3.7.1 Passages

A passage is a section that has virtual boundary on each side and that connects 2 parts of the work area. The passage must be a minimum of 2 m / 6.5 ft. wide to get a good cutting result. Short passages can be as narrow as 1 m / 3.3 ft. A long narrow passage can have a negative impact of the cutting result. A dead end must be a minimum of 2 m / 6.5 ft. wide.

3.7.2 To install the map objects in a slope

The product can operate in 45% slopes. Slopes that are too steep must be excluded from the area or isolated as stay-out zones. The gradient (%) is calculated as height per m. Example: 10 cm / 100 cm = 10%.

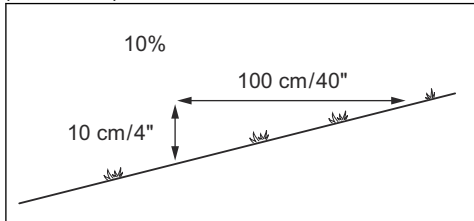

- For slopes steeper than 45% inside the work area, isolate the slope with a stay-out zone.
- For slopes steeper than 15% along the outer edge of the lawn. For installation of the virtual boundary, operate the product with the rear wheel 5 cm / 2 in. (A) from the edge.

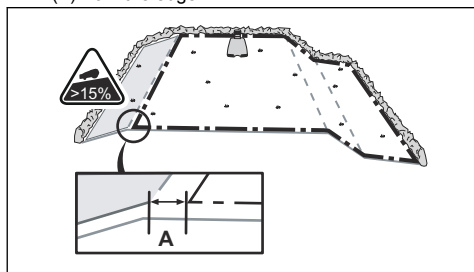

- For slopes adjacent to a public road, put a fence or a protective wall along the outer edge of the slope.

3.8 Installation of the product

3.8.1 General steps for installation of the product

For full instructions follow the installation instructions in *Installation of the product on page 15*.

1. Install the reference station.
2. Install the charging station.
3. Install the Automower® Connect app to your mobile device.
4. Pair the product with the Automower® Connect app. Do the basic settings in the start up sequence in the Automower® Connect app.
5. Make a map with work areas, stay-out zones, transport paths and point of interests.
6. Use Automower® Connect app to do settings for the product.

3.8.2 Installation tools

- Hex key, 8 mm. Included in the carton.

3.8.3 Installation of the charging station

Read and understand the instructions about the charging station. Refer to *To examine where to put the charging station on page 12*.



WARNING: Obey national regulations about electrical safety.



WARNING: The product is only to be used with the power supply unit supplied by Husqvarna.



WARNING: Do not put the power supply at a position where there is a risk that it can become wet. Do not put the power supply on the ground.



WARNING: Do not encapsulate the power supply. Condensed water can harm the power supply and increase the risk of electrical shock.



WARNING: Risk of Electric Shock. Install only to an residual-current device (RCD) with a tripping current of maximum 30 mA when connecting the power supply to the wall socket. Applicable to USA/Canada. If power supply is installed outdoors: Risk of Electric Shock. Install only to a covered Class A GFCI receptacle (RCD) that has an

enclosure that is weatherproof with the attachment plug cap inserted or removed.



CAUTION: Do not make new holes in the charging station plate.



CAUTION: Do not put your feet on the baseplate of the charging station.



WARNING: The power supply cable and extension cable must be outside the work area to avoid damage to the cables.

When connecting the power supply, only use a power outlet that is connected to an residual current device (RCD).

3.8.3.1 To install the charging station

1. Put the charging station in the selected area.
2. Attach the charging station to the ground with the supplied screws.
3. Connect the low-voltage cable to the charging station.
4. Put the power supply at a minimum height of 30 cm / 12 in. Refer to *To examine where to put the power supply on page 13*.

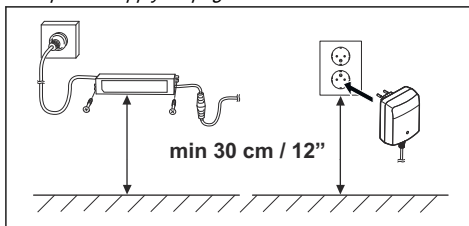

5. Connect the power supply cable to a 100-240V power outlet.
6. Put the low-voltage cable in the ground outside the work area. Use stakes or bury the cable.
7. Put the product in the charging station to charge the product.

3.8.3.2 To do a visual check of the charging station

1. Make sure that the indicator LED lamp on the charging station has a green light.

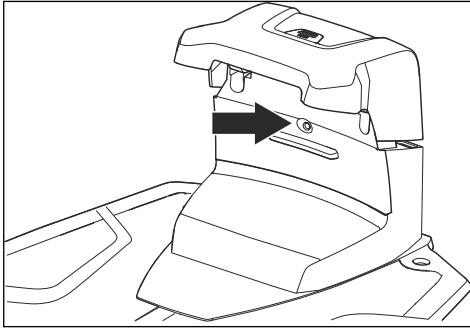

2. If the indicator LED lamp does not have a green light, do a check of the installation. Refer to *To install the charging station on page 15* and *LED indicator lamp on the charging station on page 34*.

3.8.4 Installation of the reference station

Install the reference station according to the instructions in the Operator's manual for the reference station.

3.8.5 Automower® Connect

Automower® Connect is a free app for your mobile device. Use the app for installation, settings and operation of your product. You can also find more information for example about alarm and statistics in the Automower® Connect app.

The app gives 2 modes of connectivity: Long-range cellular connectivity and Short-range Bluetooth® connectivity.

- Dashboard that shows the current status of the product and the battery state of charge.
- Account shows an overview of the account settings and the unit format can be set.
- My mowers can manage all the products paired to your account and add new ones.

Note: All countries do not support cellular connection to Automower® Connect because of regional specified cellular systems. The included Automower® Connect lifetime service only applies if there is a third part sub-supplier of 2G/4G available in the operational area.

3.8.5.1 To install the Automower® Connect app

1. Download the Automower® Connect app on your mobile device.
2. Sign up for a Husqvarna account in the Automower® Connect app.
3. An e-mail is sent to the registered e-mail address. Follow the instructions in the e-mail in less than 24 hours to validate your account.
4. Log in to your Husqvarna account in the Automower® Connect app.

3.8.5.2 Automower® Direct

You can use Automower® Direct if you have the Automower® Connect app and the PIN code for the product but no Husqvarna account.

Automower® Direct uses short-range Bluetooth® communication. Husqvarna cannot guarantee the time period or coverage of the long-range cellular connectivity. Use Bluetooth® to communicate with the product if you are in short-range of the product.

3.8.6 Husqvarna Fleet Services™

Husqvarna Fleet Services™ is a cloud solution that gives the commercial fleet manager an overview of all products. It also gives the fleet manager the possibility to control all products remotely. Husqvarna Fleet Services™ is available as a web service and as an app. When you use the Husqvarna Fleet Services™ app you will be redirected to the Automower® Connect app. For more information about Husqvarna Fleet Services™, refer to www.husqvarna.com.

3.8.6.1 To connect to the product with Husqvarna Fleet Services™

1. Download the Husqvarna Fleet Services™ app and Automower® Connect app to your mobile device.
2. Log on to the Husqvarna Fleet Services™ app.
3. Follow the instructions about how to pair the product with Husqvarna Fleet Services™.

3.8.7 To do the basic settings

When the product is switched on for the first time, there are some basic settings to do before the product can start to operate. You must pair the product and the Automower® Connect app to be able to install objects on the map, change the settings and operate the product. You can enter the Automower® Connect app directly or via the Husqvarna Fleet Services™ app.

1. Switch on the product.

Note: The Bluetooth® pairing mode is active for 3 minutes. If pairing has not been successful within this time period, switch off the product and then switch on the product again.

2. Log on to your Husqvarna account in the Automower® Connect app.
3. Start Bluetooth® on your mobile device.
4. Select *My mowers* in the Automower® Connect app, and then select add your product.
5. Enter the factory PIN code.
6. Pair the product and the reference station.
7. Pair the product and the charging station.
8. Select if you want to enable the GeoFence.

Note: It is only necessary to pair the Automower® Connect app and the product one time.

3.8.8 Installation of the map

On the map you can install the objects that follow in the Automower® Connect app:

- *Work areas (A)*
- *Stay-out zones (B)*
- *Transport path (C)*
- *Charging station (D)*
- *Point of interest (E)*
- *Work area, Secondary area (G)*

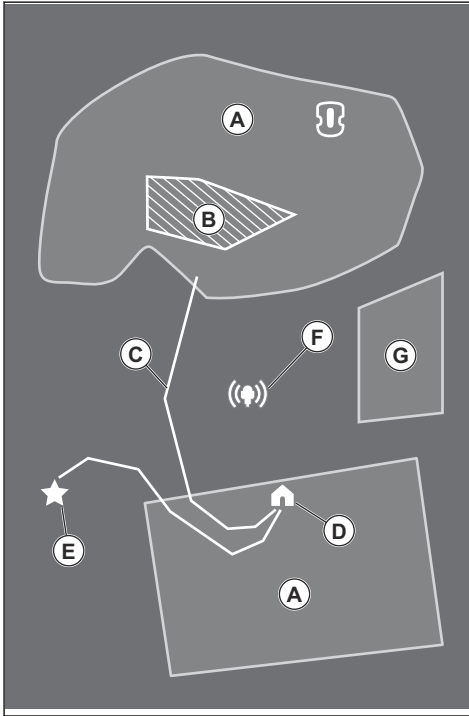

Read and understand the instructions about where to install the map objects. Refer to *To examine where to install the objects on the map on page 14*.

For a complete map installation a work area and a charging station are necessary.

A work area is an area where the product can operate and cut grass automatically. A work area is specified by virtual boundaries. The charging station can be put in the work area or near the work area that is connected to it with a transport path. A work area with no charging station in the work area and no charging station connected to it with a transport path is operated as a

secondary area. Maximum 20 work areas can be installed on a map.

A transport path is a specified path between the docking point in front of the charging station and a work area. The product can operate automatically in this path, but does not cut grass. A transport path can temporarily be enabled and disabled in the app.

Stay-out zones can be made if there are areas where the product must not operate. A stay-out zone is specified by virtual boundaries. Stay-out zones can temporarily be enabled and disabled in the app.

A point of interest is a specified position where the product can be parked at. This can for example be used for a service point where maintenance of the product is done. The point of interest is connected to the docking point with a path.

To install objects on the map, operate the product with the appDrive installation to add waypoints on the map. The status EPOS confirmed is necessary to add waypoints on the map. The waypoints (A) are positions that specifies the virtual boundaries and paths (B). The lines are straight between the waypoints. Add a number of waypoints to make smooth curves. Minimum 3 waypoints are necessary to make a work area or a stay-out zone. You can adjust the positions of the waypoints in the app after the installation of the map.

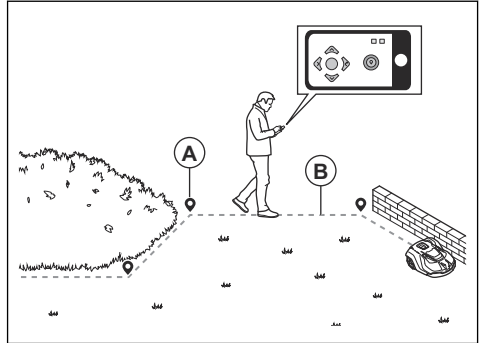

CAUTION: Do not lift and move the product between the waypoints during the installation. Use appDrive for a correct installation.

Note: The position of the waypoint when you install a work area or a stay-out zone is in the front left corner of the product.

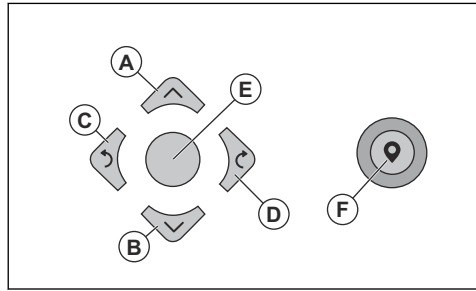
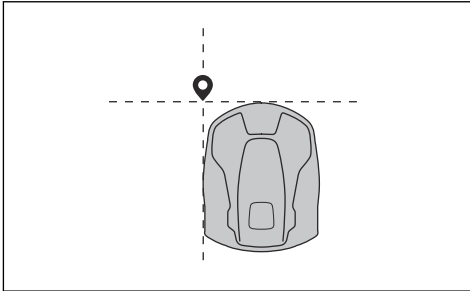

Note: Walk 2-3 m / 6.5-9.8 ft. behind the product when you operate the product with appDrive.

Note: The position of the waypoint when you install a transport path or a path to a point of interest is in the middle of the product.



To make a work area

- Operate the product clockwise around the boundary of the work area.
- Add waypoints on the map. Add the waypoints minimum 3 cm / 1 in. from obstacles.

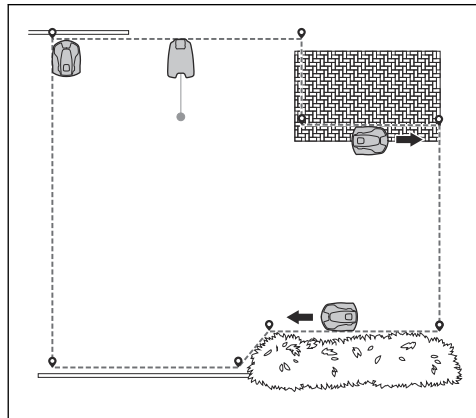

- Put the product to straddle the edge between the lawn and the stone path if it is less than 1 cm / 0.4 in. high when you add a waypoint.

3.8.8.1 To install objects on the map

Select the object you want to install and use the buttons in the appDrive installation to operate the product:

- Use the **up** button (A) to move the product forward.
- Use the **down** button (B) to move the product rearward.
- Use the left **arrow** button (C) to rotate the product to the left.
- Use the right **arrow** button (D) to rotate the product to the right.
- Use the **center** button (E) as a joystick to move and rotate the product in any direction.
- Use the **waypoint** button (F) to add a waypoint in the map.

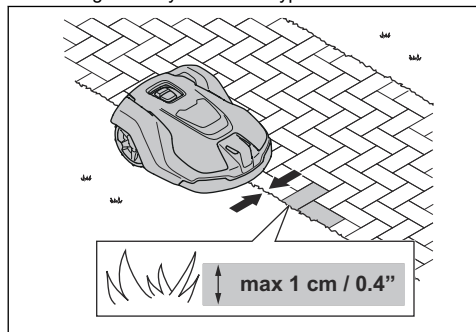

- Add the waypoint at the outer corner to install the virtual boundary around a corner.

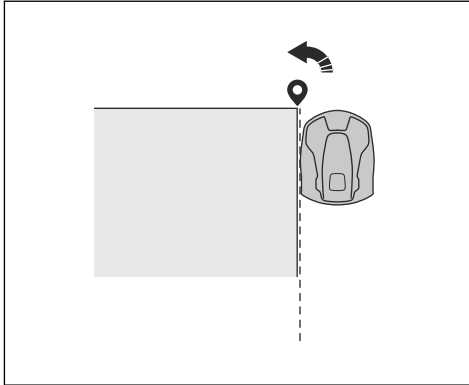

- Do not set waypoints that make a virtual boundary go across itself in the same work area.
- Save the work area to automatically connect the first and last waypoint with a virtual boundary.

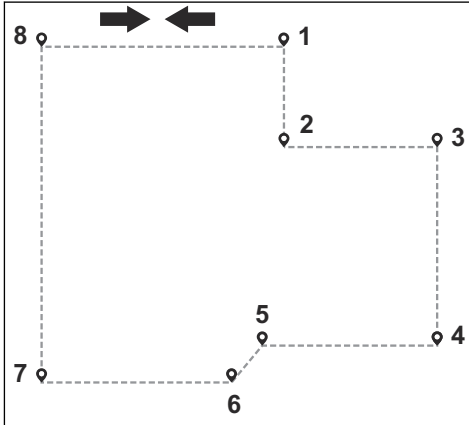

To make a stay-out zone

- Operate the product counterclockwise around the boundary of the stay-out zone.
- Add waypoints on the map. Add the waypoints minimum 3 cm / 1 in. from obstacles.
- Do not set waypoints that make a virtual boundary go across itself in the same stay-out zone.
- Save the work area to automatically connect the first and last waypoint with a virtual boundary.

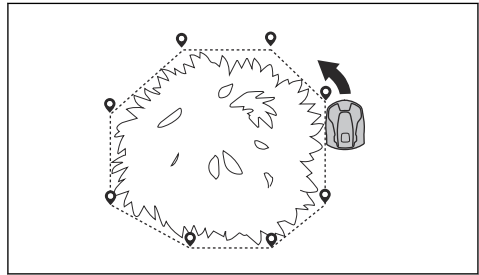

To make a transport path

- Operate the product and add waypoints on the map to install a transport path. Start in a work area minimum 1 m / 3.3 ft. from the virtual boundary.
- Do not install a transport path across a stay-out zone.
- Do not set waypoints that make a transport path go across itself.
- Operate the product and add waypoints to connect the transport path to the docking point.
- Save the transport path to automatically connect the last waypoint to the docking point.
- Set the corridor width (A) for the transport path. The corridor width can be set to 2-5 m / 6.6-16.4 ft.

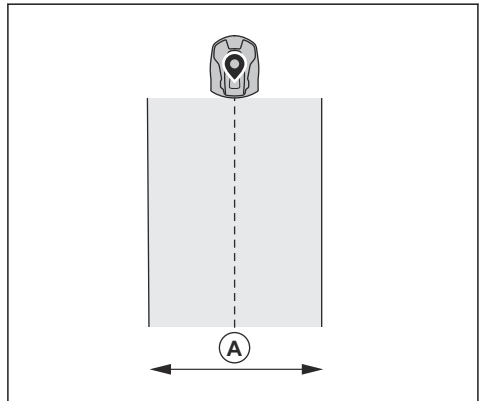

To make a point of interest

- Operate the product and add waypoints on the map. Start at the position where you want to install the point of interest. The first waypoint specifies the point of interest.
- Operate the product and add waypoints to make a path to the charging station.
- Save the point of interest to automatically connect the last waypoint to the docking point.
- Set the corridor width (A) for the point of interest. The corridor width can be set to 2-5 m / 6.6-16.4 ft.

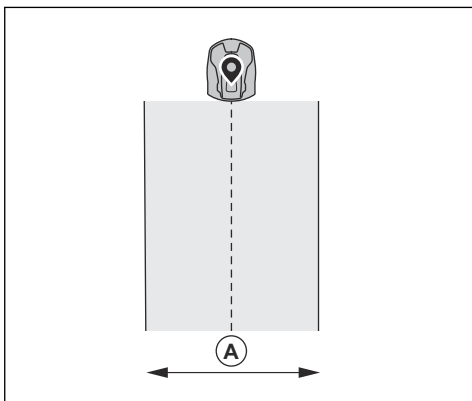

3.9 Settings in Automower® Connect

The product has factory settings but the settings can be adapted to each work area.

3.9.1 Schedule



In *Schedule* you can change the schedule settings for the product. The *Schedule* is set individually for each work area connected to the charging station. *Secondary areas* cannot be scheduled.

The schedule function controls which hours the product should operate and not operate. When the product is not operating it is parked in the charging station. The operating hours and days can be seen in an overview in the Automower® Connect app.

The default schedule setting allows the product to operate around the clock 7 days a week. This is normally a suitable setting for a work area corresponding to the maximum capacity. If the work area is less than the maximum capacity the schedule should be used to minimize wear on the grass and to the product.

To calculate the schedule setting, refer to *To calculate the schedule setting on page 20*.

3.9.1.1 To calculate the schedule setting

1. Calculate the dimension of your lawn in m^2 / ft^2 .
2. Divide the m^2 / ft^2 of the lawn with the approximate operation capacity. Refer to table below.
3. The result is equal to the number of hours that the product must operate each day.

Note: The operation capacity is approximate and is calculated for flat and open work area. If the work area

has a lot of slopes or obstacles, you need to increase the *Schedule* settings.

Model	Approximate operation capacity, m^2/h / ft^2/h
Automower® 550 EPOS	208 / 2240

Example: A lawn of $3000 m^2$ / $32000 ft^2$, cut with an Automower® 550 EPOS.

$3000 m^2 / 208 \approx 14.5 h$.

$32000 ft^2 / 2240 \approx 14.5 h$.

Days / week	h / day	Schedule settings
7	14.5	7:00 - 21:30 / 7:00 am - 9:30 pm

3.9.2 Cutting height



The cutting height is set individually for each work area. The cutting height can be set to 20-60 mm / 0.8-2.4 in.

3.9.3 Operation



In the Operation's menu it is possible to change the settings of the *Weather timer*, *ECO mode* and *Spiral cutting*.

3.9.3.1 Spiral cutting

If the product enters an area where it senses the grass is longer than average, it can change the movement pattern to *Spiral cutting*. This means that the product mows in a spiral pattern to faster cut the area with longer grass. It is possible to set the intensity of the *Spiral cutting*. *Very low* / *Low* intensity means that *Spiral cutting* begins less often. *High* / *Very high* intensity means that *Spiral cutting* begins more often.

Note: *Spiral Cutting* does not start in slopes steeper than 15%.

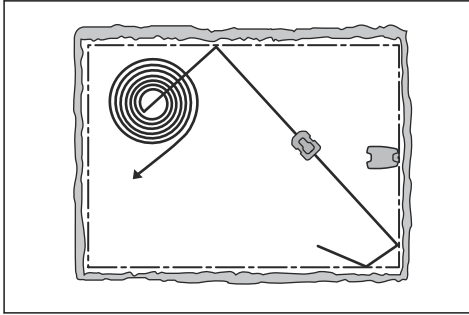

3.9.3.2 Weather timer

Weather timer automatically adjust the cutting time to the growth of the grass. The product is not permitted to operate more than the schedule settings.

Note: When using *Weather timer*, it is recommended to make as much operating time as possible available for *Weather timer*. Do not restrict the schedule more than necessary.

The first operation of the day is set by the schedule settings. The product always complete 1 mowing cycle, and then *Weather timer* selects if the product will continue to operate or not.

Note: *Weather timer* is reset if the product does not operate for more than 50 hours, or if a *Reset of all user settings* is done. *Weather timer* is not changed if a *Reset of schedule settings* is done.

3.9.3.3 ECO mode

If *ECO mode* is enabled, it switches off the signal in the charging station, when the product is parked or is charging.

Note: Use *ECO mode* to save energy and prevent interference with other equipment, for example hearing loops or garage doors.

Note: To start the product manually in the work area, push the **STOP** button before you remove the product from the charging station. If not, the product cannot park at the charging station.

3.9.4 Accessories



Settings for accessories mounted on the product can be made in this menu.

3.9.4.1 Headlights

There are 4 different headlight settings that control when the headlights are on:

- *Always ON*
- *Evening only (19:00-00:00)*
- *Evening and night (19:00-07:00)*
- *Always OFF*

The light can be set to solid or flashing light. The headlights can also be set to flash if there is an error.

3.9.4.2 To avoid collisions with the Automower® house

When this option is enabled, the wear on the product and the Automower® house is reduced, but it can result in more uncut grass around the charging station.

3.9.5 General (Bluetooth® only)



This function is used to set time and date, or to reset to default settings.

3.9.5.1 Time & date

The time and date can be changed manually, or by using the time and date from the mobile device.

3.9.5.2 Reset to factory settings

The user settings can be reset to factory settings. All objects on the map and schedule settings will be deleted.

Note: *PIN code*, *Loop signal*, *Messages* and *Date & Time* will not be reset.

3.9.6 Security (Bluetooth® only)



The security settings controls the PIN code, the GeoFence and other security functions. The correct PIN-code must be entered to get access to the *Security* menu in the Automower® Connect app.

3.9.6.1 New loop signal

The loop signal is randomly selected to create a unique link between the product and the charging station. In rare cases, there may be a need to generate a new signal, for instance if 2 adjacent installations have a very similar signal.

3.9.6.2 Change PIN code

You can change the PIN code in the Automower® Connect app. Make a note of the new PIN code in Memo. Refer to *Introduction on page 3*.

3.9.6.3 Theft protection

In the *Theft protection* menu it is possible to set the alarm duration and also what events should trigger the alarm. The factory setting is to require PIN code and the alarm duration is 1 min.

Require PIN code

This function means that the product cannot be operated or controlled after the **STOP** button has been pushed without first entering the correct PIN code. If the incorrect PIN code is entered 5 times, the product is locked for a time. The lock is extended for each new incorrect try.

Alarm duration

There is a possibility to set how long the alarm signal should last. A setting between 1 and 10 minutes is possible.

STOP button pressed

If the alarm "*STOP button pressed*" is enabled, the alarm goes off if someone presses the **STOP** button and the PIN code is not entered within 30 seconds.

Carried away

If the alarm *Carried away* is enabled, the product senses unexpected motions, and the alarm goes off.

3.9.6.4 GeoFence

GeoFence is a GPS-based theft protection that makes a virtual fence for the product. If the product is more than a set distance away from the center position the product will be deactivated and an alarm will start. The center position will be set to the current position of the product when the function is enabled. The PIN code is needed to deactivate the alarm and to start the product again. The GeoFence is only enabled when the product is switched on.

3.9.7 Automower® Connect (Bluetooth® only)



In *Automower® Connect* you can enable or disable the Automower® Connect module. You can also see the signal strength, connectivity status, initiate new pairing or remove the product from the paired accounts.

3.9.8 Messages (Bluetooth® only)

In this menu the previous fault and information messages can be found. For some of the messages, there are tips and advice to help to rectify the fault.

Note: The *Messages* menu is only available for Bluetooth® short-range connectivity.

If the product is disrupted in any way, for example it is trapped or the battery is low, a message is saved relating to the disruption and the time it happened.

If the same message is repeated several times, this may indicate that an adjustment to the installation or the product is required. Refer to *Installation on page 12*.

3.9.9 Download firmware over the air (Firmware over the air FOTA)

The product has a function that automatically downloads new firmware. When a new firmware is available, a notification shows in the app where you can select to install the new firmware. In the factory setting this function is enabled.

4 Operation

4.1 Main switch



WARNING: Read the safety instructions carefully before you start the product.



WARNING: Keep your hands and feet away from the rotating blades. Do not put your hands or feet near to or below the product when the cutting motor is on.



WARNING: Do not use the product when persons, especially children, or animals are in the work area.

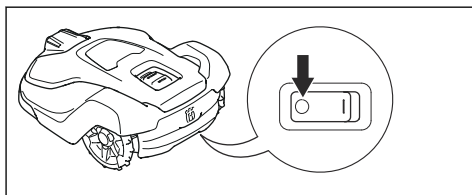

- Set the **Main switch** in the *1* position to start the product.
- Set the **Main switch** in the *0* position when the product is not in use or before you do inspection or maintenance on the product.

4.2 To start the product

1. Set the **Main switch** to position *1*.
2. Open the Automower® Connect app.
3. Enter the PIN code.
4. Push the **START** button on the product.

4.3 Operating mode - Start

When you select *Start* in the app you can select the operation selections that follow:

- *Resume Schedule*
- *appDrive*
- *Select area*

4.3.1 Resume Schedule

The product will continue to operate on the scheduled work area where it cuts the grass and charges automatically.

4.3.2 appDrive

Use the appDrive to operate the product manually.

4.3.2.1 To operate the product with appDrive

Use the buttons to operate the product:

- Use the **up** button (A) to move the product forward.
- Use the **down** button (B) to move the product rearward.
- Use the left **arrow** button (C) to rotate the product to the left.
- Use the right **arrow** button (D) to rotate the product to the right.
- Use the **center** button (E) as a joystick to move and rotate the product in any direction.

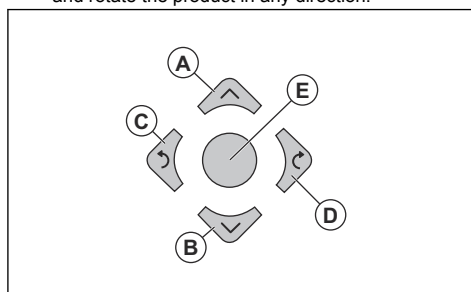

Note: Walk 2-3 m / 6.5-9.8 ft. behind the product when you operate the product with appDrive.

4.3.3 Select area

You can select if you want the product to temporarily operate in a selected work area and not according to the set schedule. Select for how long time the product must operate in the selected area. When this is completed the product will continue to operate according to schedule.

4.3.3.1 Secondary area

For the product to operate in a secondary area, you must move the product manually to and from the secondary area. The product cuts for a selected period of time or until the battery is empty.

4.4 Operating mode - Park

When you select *Park* in the app you can select the operation selections that follow:

- *Park until further notice*
- *Select duration*

4.4.1 Park until further notice

The operation mode *Park* means that the product goes back to the charging station where it stays until a new

operation mode is selected and the **START** button is pushed.

4.4.2 Select duration

The product goes back to the charging station and stays for the selected park duration. Use the operation selection to temporary stop an ongoing mowing cycle and let the product to stay in the charging station.

4.4.3 Operating mode - Pause

When selecting *Pause* in the Automower® Connect app, the product stop the current activity and pause. The product is paused until either *Park* or *Start* is selected in the Automower® Connect app.

4.5 To stop the product

1. Push the **STOP** button on top of the product.

The product stops and the blade motor stops.

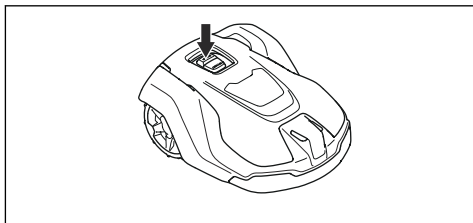

Note: When you push the **START** button again, the product continues to operate in the same operating mode as before.

4.6 To switch off the product

1. Push the **STOP** button on top of the product.
2. Enter the Automower® Connect app and connect to the product with Bluetooth® short-range.

Note: If the product is not connected to Automower® Connect with Bluetooth® when setting the **Main switch** to 0, the product is disabled but not switched off. When the product is disabled the motors are not allowed to run.

3. Set the **Main switch** to position 0.

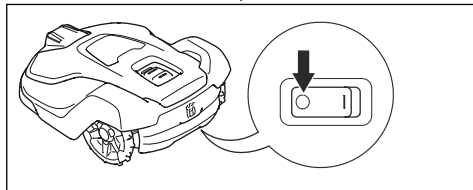

WARNING: Always switch off the product using the **Main switch** if it requires maintenance, or if the product must be moved outside the work area.

4.7 To charge the battery



WARNING: Only charge the product using a charging station which is intended for it. Incorrect use may result in electric shock, overheating or leakage of corrosive liquid from the battery.

In the event of leakage of electrolyte flush with water and seek medical help if it comes in contact with the eyes etc.

When the product is new or has been in storage for a long period, the battery can be empty, charge the battery before you start the product.

1. Set the **Main switch** to position *1*.
2. Put the product in as far as possible in the charging station. Make sure that the product and the charging station is connected. Refer to contact and charging strips in *Product overview on page 5*.
3. Make sure that the charging is in progress in the Automower® Connect app.

5 Maintenance

5.1 Introduction - maintenance



WARNING: The product must be switched off before any maintenance is done. The product is disabled when the **Main switch** is in position 0.



WARNING: Wear protective gloves.

For better operation and longer service life, make sure to clean the product regularly and replace worn parts. All maintenance and servicing must be done according to Husqvarna's instructions. Refer to *Warranty on page 41*.

When the product is first used, the blade disc and blades should be inspected once a week. If the amount of wear during this period has been low, the inspection interval can be increased.

It is important that the blade disc rotates easily. The edges of the blades should not be damaged. The lifetime of the blades varies immensely and depends for instance on:

- Operating time and size of the work area.
- Type of grass and seasonal growth.
- Soil, sand and use of fertilizers.
- The presence of objects such as cones, windfalls, toys, tools, stones, roots and the like.

The normal life is 2 to 5 weeks when used under favorable conditions. Refer to *Replace the blades on page 26* on how to replace the blades.

Note: Working with blunt blades gives a poorer mowing result. The grass is not cut cleanly and more energy is needed resulting in the product not mowing such a large area.

5.2 Clean the product

It is important to keep the product clean. A product with large quantity of grass blocked to it will not cope as good with slopes. It is recommended to clean using a brush.

Husqvarna recommends to use a special cleaning and maintenance kit, available as an accessory. Speak to your Husqvarna representative for more information.



CAUTION: Do not use a high-pressure washer to clean the product and the charging station. Do not use solvents for cleaning.

5.2.1 Chassis and blade disc

Inspect the blade disc and blades once a week.

1. Set the **Main switch** to position 0.
2. Lift the product onto its side.
3. Clean the blade disc and chassis using for example a dish brush. At the same time, check that the blade disc rotates freely in relation to the foot guard. Also, check that the blades are intact and can pivot freely.

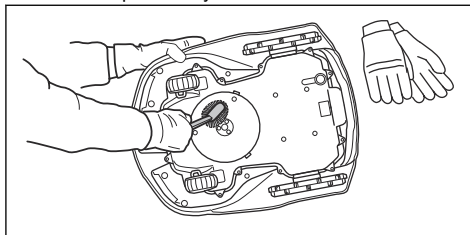

5.2.2 Chassis

Clean the underside of the chassis. Brush or wipe with a damp cloth.

5.2.3 Wheels

Clean around the wheels. Grass on the wheels can impact on how the product performs in slopes.

5.2.4 The body of the product

Use a moist, soft sponge or cloth to clean the body of the product. If the body of the product is dirty, use a mild soap solution to clean it.

5.2.5 Charging station



WARNING: Disconnect the power supply from the power outlet before any maintenance, or cleaning of charging station or power supply.

Clean the charging station regularly from grass, leaves, twigs and other objects that may impede docking.

5.3 Replace the blades



WARNING: Use blades and screws of the right type. Husqvarna can only guarantee safety when using original blades. Only replacing the blades and reusing the screw can result in a screw wearing during mowing. The blades can then be propelled from under the body and cause serious injury.

Replace worn or damaged parts for safety reasons. Even if the blades are intact, they should be replaced on a regular basis for the best mowing result and low energy usage. All 3 blades and screws must be replaced at the same time to obtain a balanced cutting system. Use Husqvarna original blades embossed with the crowned H-mark logotype, refer to *Technical data on page 38*.

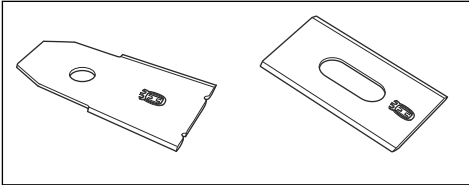

5.3.1 To replace the blades

1. Push the **STOP** button
2. Set the **Main switch** to position 0.

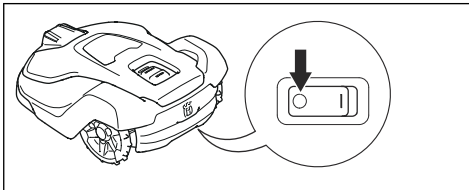

3. Turn the product upside down. Put the product on a soft and clean surface to avoid scratching the product.
4. Rotate the skid plate so that its holes align with the screws for the blade.
5. Remove the 3 screws with a screwdriver.

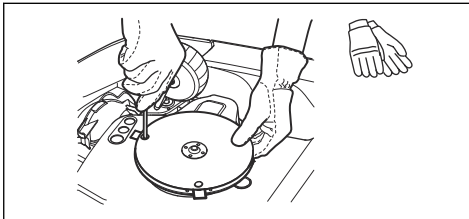

6. Remove the 3 blades.

7. Attach 3 new blades and screws.
8. Make sure that the blades can pivot freely.

5.4 Battery



WARNING: Only charge the product using a charging station which is intended for it. Incorrect use may result in electric shock, overheating or leakage of corrosive liquid from the battery. In the event of leakage of electrolyte flush with water and seek medical help if it comes in contact with the eyes etc.



WARNING: Use only original batteries recommended by the manufacturer. Product safety cannot be guaranteed with other batteries. Do not use non-rechargeable batteries.



CAUTION: The battery must charge a complete cycle before winter storage. If the battery is not fully charged it can be damaged and in certain cases be rendered useless.

If the operating time for the product is shorter than normal between charges, this indicates that the battery is getting old and eventually needs replacing.

Note: Battery life is dependent on the length of the season and how many hours a day the product is operating. A long season or many hours of use a day means that the battery must be replaced more regularly. The battery is fine as long as the product maintains a well-cut lawn.

5.5 Winter service

Take your product to your Husqvarna central service for service prior to winter storage. Regular winter service will maintain the product in good condition and create the best conditions for a new season without any disruptions.

Service usually includes the following:

- Thorough cleaning of the body, the chassis, the blade disc and all other moving parts.
- Testing of the product's function and components.
- Checking and, if required, replacing wear items such as blades and bearings.
- Testing the product's battery capacity as well as a recommendation to replace battery if necessary.
- If new firmware is available, the product is updated.

6 Troubleshooting

6.1 Introduction - troubleshooting

All messages can be found in the *Messages* menu in Automower® Connect. More suggestions for steps to take in the event of malfunction or symptoms can be found on www.husqvarna.com.

Note: The *Messages* menu is only available for short-range connectivity (Bluetooth®).

6.2 Fault messages

The fault messages in the table below are shown in the Automower® Connect app. Speak to your Husqvarna representative if the same message shows frequently.

Message	Cause	Action
<i>Cutting system blocked</i>	Grass or other objects is wound around the blade disc.	Examine the blade disc and remove the grass or other object.
	The blade disc is in a pool of water.	Move the product and prevent the collection of water in the work area.
	The grass is high and thick.	Adjust the cutting height to the height of the grass. Adjust the schedule settings to increase the mowing time.
<i>Trapped</i>	The product is blocked in a small area behind a number of obstacles.	Examine if there are obstacles which make it hard for the product to move away from this location.

Message	Cause	Action
<i>No loop signal</i>	The power supply or the low-voltage cable for the charging station is not connected.	Examine the LED status on the charging station. If there is no power to the charging station, the LED is not lit. Examine the wall socket connection and if a residual-current device is engaged. Make sure that the low-voltage cable is connected to the charging station.
	The power supply or the low-voltage cable for the charging station is damaged.	Replace the power supply or low-voltage cable.
	<i>ECO mode</i> is enabled and the LED indicator lamp on the charging station is flashing green. The product has been started manually in the work area without pushing the STOP button before removing the product from the charging station. The charging station signal is disabled and the product cannot enter the charging station. Refer to <i>ECO mode</i> on page 21.	Put the product in the charging station. Start the product. Refer to <i>To start the product</i> on page 23.
	The product does not find the loop signal from the charging station.	Put the product in the charging station and generate a new loop signal. Refer to <i>New loop signal</i> on page 21.
	The charging station is not installed correctly.	Install the charging station according to the instruction. Refer to <i>To install the charging station</i> on page 15.
	Interference from metal objects such as fences, reinforcement steel or buried cables near the charging station.	Change the position of the charging station.
<i>Outside work area</i>	The work area slopes too much by the virtual boundary.	Make sure that the virtual boundary is installed correctly. Refer to <i>To examine where to install the objects on the map</i> on page 14.
	The transport path or the path to the point of interest slopes too much.	Make sure that the transport path is installed correctly. Refer to <i>To install the map objects in a slope</i> on page 14.
	The product finds it hard to distinguish the charging station signal from another product installation close by.	Put the product in the charging station and generate a new loop signal. Refer to <i>New loop signal</i> on page 21.
	Interference from metal objects such as fences, reinforcement steel or buried cables near the charging station.	Change the position of the charging station.

Message	Cause	Action
<i>Empty battery</i>	The product cannot find the charging station.	The product has no accurate position and cannot find the charging station. There is an obstacle preventing the product to find the charging station.
	The battery is at the end of its life cycle.	Replace the battery. Refer to <i>Battery on page 26</i> .
	The charging station's antenna is defective.	Check if the indicator lamp in the charging station flashes red. Refer to <i>LED indicator lamp on the charging station on page 34</i> . This problem requires action by authorized service technician.
<i>No drive</i>	The product has hit an obstacle and stopped or the wheels cannot move on the wet grass.	Free the product and rectify the reason for the lack of drive. If it is due to wet grass, wait until the lawn has dried before using the product.
	The work area includes a steep slope.	Maximum guaranteed slope is 45%. Steeper slopes should be isolated. Refer to <i>To install the map objects in a slope on page 14</i> .
<i>Wheel motor overloaded right, left</i>	Grass or other objects is wound around the drive wheel.	Examine the drive wheel and remove grass or other objects.
<i>Charging station blocked</i>	The contact between the charging strips and contact strips may be poor and the product has made a number of attempts to charge.	Put the product in the charging station and check that the charging plates and contact plates make good contact.
	An object is obstructing the product.	Remove the object.
	The charging station is tilted or bent.	Confirm that the charging station is placed on a fully flat and horizontal ground. The charging station must not be tilted or bent.
<i>Stuck in charging station</i>	The product slips on the baseplate.	Clean the baseplate.
	There is an object in the way of the product preventing it from leaving the charging station.	Remove the object.
<i>Upside down</i>	The product is leaning too much or has turned over.	Turn the product the right way up.
<i>Mower tilted</i>	The product is tilted more than the maximum angle.	Move the product to a flat area.
<i>Lifted</i>	The lift sensor is engaged because the product hit an object or/and is blocked.	Free the product. If the problem stays, speak to your approved servicing dealer.
<i>Collision</i>	The body of the product can not move freely around its chassis.	Remove dirt or objects between the chassis and the body to make sure that the body can move freely around the chassis.
	The product has become stuck.	Free the product and rectify the reason.

Message	Cause	Action
<i>Wheel motor blocked right/left</i>	Grass or other object is wrapped around the drive wheel.	Clean the wheels and around the wheels.
<i>Alarm! Mower stopped</i>	The alarm was activated because the product was stopped.	Adjust the mower security settings in the <i>Security</i> menu. Refer to <i>Security (Bluetooth® only)</i> on page 21.
<i>Alarm! Mower outside Geo-fence</i>	Alarm activated as the product was moved outside the GeoFence area.	
<i>Alarm! Mower was moved</i>	Alarm activated as the product has been moved.	
<i>Electronic problem</i>	Temporary electronic or firmware related issue in the product.	Restart the product.
<i>Loop sensor problem</i>		If the problem stays, speak to your approved servicing dealer.
<i>Charging system problem</i>		
<i>Tilt sensor problem</i>		
<i>Temporary problem</i>		
<i>Invalid sub-device combination</i>		
<i>Temporary battery problem</i>		
<i>Faulty mix of batteries</i>		
<i>Collision sensor problem</i>		
<i>Lift sensor problem</i>		
<i>Battery problem</i>	Temporary battery or firmware related issue in the product.	Restart the product. If the problem stays, speak to your approved servicing dealer.
	Wrong type of battery.	Use only original batteries recommended by the manufacturer.
<i>Battery temperature outside limits</i>	The product does not operate if the battery temperature is too high or too low.	The product starts to operate again when the temperature is between the set limits and the schedule settings let the product to operate. Make sure that the charging station is put in an area with protection from the sun.
<i>Charging current too high</i>	Wrong or faulty power supply unit.	Restart the product. If the problem stays, speak to your approved servicing dealer.

Message	Cause	Action
<i>Map problem</i>	There is no defined work area.	Make a work area in the Automower® Connect app. Refer to <i>To make a work area on page 18</i> .
	The charging station or the reference station has been moved.	Move the charging station or the reference station to their original positions.
		Do a new installation of the map.
	The map object file is incorrect.	Do a check of the map in the app. Adjust the map and save it.
Delete the map and do a new installation.		
<i>Wheel drive problem, right/left</i>	Grass or other objects is wound around the drive wheel.	Examine the drive wheel and remove grass or other objects.
<i>Searching for position</i>	Weak satellite signal to the reference station.	The satellite signal is temporary weak. The product will start to operate when the satellite signals are good.
		Examine the installation of the reference station. Refer to the Operator's manual for the Reference station.
	Weak satellite signal to the product.	The satellite signal is temporary weak. The product will start to operate when the satellite signal are good.
		The area includes parts where the satellite signal is weak. Examine if the product has satellite signal in all parts of the work area. Examine if the sky is obscured. If possible, remove obstructing objects. Otherwise, redo the installation and exclude these parts. Refer to <i>Installation of the map on page 17</i>
<i>No accurate position from satellites</i>	Weak satellite signal to the reference station.	Examine the installation of the reference station. Refer to the Operator's manual for the Reference station.
	Weak satellite signal to the product.	The area includes parts where the satellite signal is weak. Examine if the product has satellite signal in the complete area. Examine if the sky is obscured. If possible, remove obstructing objects. Otherwise, redo the installation and exclude these parts. Refer to <i>To make a work area on page 18</i>

Message	Cause	Action
<i>Reference station communication problem</i>	The product is not paired with the reference station.	Redo the pairing with the reference station.
	The reference station is not installed correctly.	Examine the installation of the reference station. Refer to the Operator's manual for the Reference station.
	The reference station radio signal does not cover the complete area.	Test if the product has radio signal from the reference station in the complete area. If not, redo the installation of the reference station or the installation of the map. Refer to <i>Installation of the map on page 17</i> .
	Power failure.	Find and rectify the cause for power failure for the reference station.
	There is an error in the reference station and the LED status indicator is flashing red.	Disconnect the power to the reference station and connect it again to restart the reference station. If the problem stays, speak to your approved servicing dealer.
<i>Unexpected cutting height adj</i>	The cutting height adjustment cannot move.	Examine the cutting height adjustment and remove grass or other objects. If the problem stays, speak to your approved servicing dealer.
<i>Limited cutting height range</i>		
<i>Cutting height problem</i>		
<i>Cutting height blocked</i>		
<i>Cutting system major imbalance</i>	The product has discovered vibrations in the cutting disc.	Continued operation can cause damage to the cutting system. Make sure that the blades and screws are not damaged and not worn. Make sure that all blades are correctly attached. Make sure that there is only one blade attached on each position in the blade disc.

6.3 Information and warning messages

The information messages in the table below are shown in the *Messages* menu in the Automower® Connect app. Speak to your Husqvarna representative if the same message shows frequently.

Message	Cause	Action
<i>Low battery</i>	The product cannot find the charging station.	The product has no accurate position and cannot find the charging station. There is an obstacle preventing the product to find the charging station.
	The battery is at the end of its life cycle.	Replace the battery. Refer to <i>Battery on page 26</i> .
	The charging station's antenna is defective.	Check if the indicator lamp in the charging station flashes red. Refer to <i>LED indicator lamp on the charging station on page 34</i> . This problem requires action by authorized service technician.
<i>Cutting system imbalance</i>	The product has discovered vibrations in the cutting disc.	Make sure that the blades and screws are not damaged and not worn. Make sure that all blades are correctly attached. Make sure that there is only one blade attached in each position on the blade disc.
<i>Connectivity problems</i>	Problem with the Automower® Connect module.	Restart the product. If there still is a connection problem, try to unpair the product (<i>My mowers</i>) and then pair it again. If the problem remains, speak to your local Husqvarna representative.
<i>Wrong PIN code</i>	An incorrect PIN code has been entered. 5 tries are permitted, and the product is then blocked for a period of time.	Enter the correct PIN code. If the PIN code is incorrect, use the link in the app to send the PIN code to your registered e-mail address. If you have not registered the e-mail address, speak to your local Husqvarna representative.
<i>Ultrasonic problem</i>	Temporary electronic or firmware related issue in the product.	Restart the product.
<i>GPS navigation problem</i>		If the problem stays, speak to your approved servicing dealer.

6.4 LED indicator lamp on the charging station

For a fully functional installation, the indicator lamp in the charging station must show a solid or flashing green light. If another color shows, follow the troubleshooting guide below.

There is more help on www.husqvarna.com. If you still need help, speak to your local Husqvarna representative.

Light	Status
Green solid light	Good signals.
Green flashing light	The signals are good and <i>ECO mode</i> is activated. Refer to <i>ECO mode on page 21</i> .
Red flashing light	Interruption in the charging station's antenna. Speak to your local Husqvarna representative.
Red solid light	Fault in the circuit board or incorrect power supply in the charging station. The fault must be correct by an authorized service technician. Speak to your local Husqvarna representative.

6.5 LED indicator lamp on the product

The LED indicator lamp on top of the product shows the current status:

Light	Status
Green solid light	The product is mowing the lawn or leaving the charging station.
Green flashing light	The product is paused.
Red flashing light	The product has stopped due to an error.
Yellow solid light	The STOP button has been pushed.
Yellow flashing light	The product requests the PIN code.
Blue solid light	The product is on its way to the charging station or a point of interest.
	An app is connected to the product with Bluetooth®, the blue solid light is lit for 3 seconds.
Blue pulsating light	The product is charging in the charging station.
Blue flashing light	The product is parked in charging station.
	The product can at this time find the Bluetooth® to connect with.
White solid light	The product is in appDrive mode.
White pulsating light	The product switching off.
	Firmware installation is ongoing.
White flashing light	The firmware must be updated.

There is more help on www.husqvarna.com. If you still need help, speak to your local Husqvarna representative.

6.6 Symptoms

If your product does not work as expected, follow the symptoms guide below.

Symptoms	Cause	Action
The Main switch is set to 0 but the product is not switched off.	The Main switch was set to 0 when the product was not connected to the Automower® Connect app with Bluetooth®. The product is disabled but not switched off.	Set the Main switch to 1 and connect the product to the Automower® Connect app with Bluetooth® and set the Main switch to 0.
The product has difficulty docking.	The charging station is on a slope.	Place the charging station on a surface that is entirely level. Refer to <i>To examine where to put the charging station on page 12.</i>
	The charging station is put too far from the work area.	Delete the work area and make a new work area or move the charging station.
The product runs at the wrong time.	The product clock needs to be set.	Set the clock. Refer to <i>Time & date on page 21.</i>
	The start and stop times for mowing are incorrect.	Reset the start time and stop time settings for mowing. Refer to <i>Schedule on page 20.</i>
The product vibrates.	Damaged blades lead to imbalance in the cutting system.	Inspect the blades and screws and replace them if necessary. Refer to <i>To replace the blades on page 26.</i>
	Too many blades in the same position lead to imbalance in the cutting system.	Check that only one blade is fitted at each screw.
	Different versions (thickness) of Husqvarna blades are used.	Check if the blades are of different versions.
The product runs, but the blade disc does not rotate.	The product searches for the charging station.	No action. The blade disc does not rotate when the product is searching for the charging station.
The product mows for shorter periods than usual between charges.	Grass or other foreign object blocks the blade disc.	Remove and clean the blade disc. Refer to <i>Chassis and blade disc on page 25.</i>
	The battery is at the end of its life cycle.	Replace the battery. Refer to <i>Battery on page 26.</i>
	The grass is high and thick and requires more energy to cut.	Increase the cutting height and then successively lower it.
Both the mowing and charging times are shorter than usual.	The battery is at the end of its life cycle.	Replace the battery. Refer to <i>Battery on page 26.</i>

Symptoms	Cause	Action
The product is parked for hours in the charging station.	The product is parked due to a schedule setting, or because <i>Park until further notice</i> has been chosen in the app.	Open the app and edit the schedule settings, or go to <i>Dashboard</i> and start the product.
	The product does not operate if the battery temperature is too high or too low.	The product starts to operate again when the temperature is between the set limits and the schedule settings let the product to operate. Make sure that the charging station is put in an area with protection from the sun.
The product often moves in circles or spirals.	Spiral cutting is a natural part of the product's movement pattern.	Adjust the intensity of spiral cutting. This function can be disabled if necessary. Refer to <i>Spiral cutting on page 20</i> .
The product turns round and stays on a small area for several minutes.	This is completely normal for the product. The product has GPS assisted navigation that contributes to an even result.	No action.
Cannot pair the mobile device with the product.	The product is already paired with another app or another mobile device nearby.	Close the app that is not to be used and try again.
Uneven mowing results.	The product works too few hours per day.	Increase the mowing time. Refer to <i>Schedule on page 20</i> .
		The <i>Weather timer</i> senses that the lawn has been mowed more than it actually has. Increase the intensity level in the <i>Weather timer</i> . Disable the <i>Weather timer</i> if this does not help.
	Work area is too large.	Try to limit the work area, or to extend the work time. Refer to <i>To calculate the schedule setting on page 20</i> .
	Dull blades.	Replace all the blades. Refer to <i>To replace the blades on page 26</i> .
	Long grass in relation to the set cutting height.	Increase the cutting height and then successively lower it.
	Accumulation of grass by the blade disc or around the motor shaft.	Check that the blade disc rotates freely and easily. If not, screw off the blade disc and remove grass and foreign objects. Refer to <i>Chassis and blade disc on page 25</i> .

7 Transportation, storage and disposal

7.1 Transportation

The supplied Li-ion batteries obey the Dangerous Goods Legislation requirements.

- Obey all applicable national regulations.
- Obey the special requirement on package and labels for commercial transportations, including by third parties and forwarding agents.

7.2 Storage

- Fully charge the product. Refer to *To charge the battery on page 24*.
- Disconnect the product with the **Main switch**. Refer to *To switch off the product on page 24*.
- Clean the product. Refer to *Clean the product on page 25*.
- Keep the product in a dry, frost free space.
- Keep the product with all wheels on level ground during storage, or use a Husqvarna wall hanger.
- If you keep the charging station indoors, disconnect and remove the power supply from the charging station.

Note: If you keep the charging station outdoors, do not disconnect the power supply and the connectors.

7.3 Disposal

- Obey the local recycling requirements and applicable regulations.
- For questions about how to remove the battery, refer to *To remove the batteries on page 37*.

7.3.1 To remove the batteries



CAUTION: Only remove the batteries when you dispose the product. When you remove the warranty seal, the Husqvarna warranty is no longer applicable.

1. Disconnect the product with the **Main switch**. Refer to *To switch off the product on page 24*.
2. Pull out the grommet on the charging cable at the very front of the product, and carefully remove the connector.
3. Lift the cover, one corner at a time.
4. Remove the 14 screws with a Torx 20.

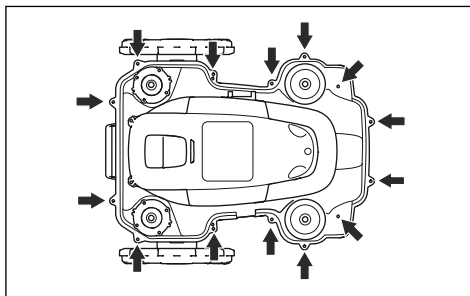

5. Lift the rear edge of the top section of the chassis.
6. Disconnect the cable from the main circuit board.
7. Remove the top section of the chassis.
8. Remove the 3 screws that holds the batteries with a Torx 20.

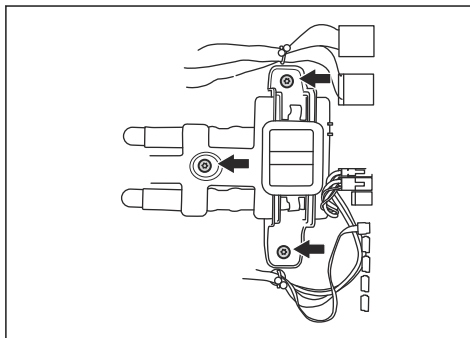

9. Disconnect the batteries connection from the main circuit board.

8 Technical data

8.1 Technical data

Dimensions	Automower® 550 EPOS
Length, cm / in.	72 / 28.3
Width, cm / in.	56 / 22
Height, cm / in.	32 / 12.6
Weight, kg / lbs	14.4 / 31.7

Electrical system	Automower® 550 EPOS
Battery, Lithium-Ion 18V, 5.0 Ah, Art. No	593 11 84-01, 593 11 85-01, 593 11 84-03 (2 pcs.) 5.0 Ah/battery
Battery, Lithium-Ion 18V, 4.9 Ah, Art. No	593 11 84-02, 593 11 85-02 (2 pcs.) 4.9 Ah/battery
Power supply (28V DC), V AC	100-240
Low-voltage cable for charging station, length m/ft.	10 / 33
Mean energy consumption at maximum use	23 kWh/month in a 5000 m ² work area
Charging current, A DC	7
Type of Power Supply Unit for charging station ⁵	FW7458/28/D/XX/Y, ADP-200JR XX, ADP-200MR XX
Average mowing time, min	210
Average charging time, min	60

Charging station wire antenna	Automower® 550 EPOS
Operating Frequency Band, Hz	300-80000
Maximum magnetic field, dBuA/m	82
Maximum Radio-frequency power ⁶ , mW @60m	<25 mW @60m

Noise emissions measured in the environment as sound power⁷	Automower® 550 EPOS
Measured sound power noise level, dB (A)	63
Noise emissions uncertainties K _{WA} , dB (A)	3
Sound pressure noise level at the operator's ear, dB (A) ⁸	55

⁵ XX, YY can be any alphanumeric characters or blank for marketing purpose only, no technical differences.

⁶ Maximum active output power to antennas in the frequency band in which the radio equipment operates.

⁷ Determined according to Directive 2006/42/EC and standard EN 50636-2-107.

⁸ Sound pressure noise uncertainties K_{pA}, 2-4 dB (A).

Mowing	Automower® 550 EPOS
Cutting system	3 pivoted cutting blades
Maximum blade motor speed, rpm	2700
Power consumption during cutting, W +/- 20 %	35
Cutting height, cm / in.	2-6 / 0.8-2.4
Cutting width, cm / in.	24 / 9.4
Narrowest possible passage, m / ft.	2 / 6.5
Maximum angle for cutting area, %	45
Maximum angle for virtual boundary, %	15
Working capacity, m ² / acre(s) +/- 20%	5000 / 1.25

IP-classification	Automower® 550 EPOS
Robotic lawn mower	IPX4
Charging station	IPX1
Power supply charging station	IP44

Frequency Band Support	
Bluetooth® Frequency range	2400.0-2483.5 MHz
Automower® Connect 2G	GSM 850 MHz, E-GSM 900 MHz, DCS 1800 MHz, PCS 1900 MHz
Automower® Connect 4G	Band 12 (700 MHz), Band 17 (700 MHz), Band 28 (700 MHz), Band 13 (700 MHz), Band 20 (800 MHz), Band 26 (850 MHz), Band 5 (850 MHz), Band 19 (850 MHz), Band 8 (900 MHz), Band 4 (1700 MHz), Band 3 (1800 MHz), Band 2 (1900 MHz)
SRD868 (Europe)	863-870 MHz
SRD915 (North America)	902-928 MHz

Power Class		
Bluetooth® Output power	8 dBm	
Automower® Connect 2G	Power Class 4 (GSM/E-GSM)	33 dBm
	Power Class 1 (DCS/PCS)	30 dBm
	Power Class E2 (GSM/E-GSM)	27 dBm
	Power Class E2 (DCS/PCS)	26 dBm
Automower® Connect 4G	Power Class 3	23 dBm
SRD868 (Europe)	13 dBm	
SRD915 (North America)	13 dBm	

Full compatibility cannot be guaranteed between the product and other types of wireless systems such as remote controls, radio transmitters, hearing loops, buried electric animal fencing or similar.

The products are made in England or the Czech Republic. See information on the rating plate. Refer to *Product overview on page 5*.

8.2 Registered trademarks

The *Bluetooth®* word mark and logos are registered trademarks owned by *Bluetooth SIG, inc.* and any use of such marks by Husqvarna is under license.

9 Warranty

9.1 Warranty terms

Husqvarna® warranty covers this product's functionality for a period of 2 years from date of purchase. The warranty covers serious faults relating to materials or manufacturing faults. Within the warranty period, we will replace the product or repair it at no charge if the following terms are met:

- The product and the charging station may only be used in compliance with the instructions in this Operator's Manual. This manufacturer's warranty does not affect warranty entitlements against the dealer/retailer.
- End-users or non-authorized third parties must not attempt to repair the product.

Examples of faults which are not included in the warranty:

- Damage caused by water seepage from using a high-pressure washer, or from being submerged under water, for example when heavy rain forms pools of water.
- Damage caused by lightning.
- Damage caused by improper battery storage or battery handling.
- Damage caused by using a battery that is not a Husqvarna original battery.
- Damage caused by not using Husqvarna original spare parts and accessories, such as blades and installation material.
- Damage caused by non-authorized changing or tampering with the product or its power supply.

The blades and wheels are seen as disposable and are not covered by the warranty.

If an error occurs with your Husqvarna product, please contact Husqvarna customer service for further instructions. Please have the receipt and the product's serial number at hand when contacting Husqvarna customer service.

10 Applicable to US/CA market

10.1 Supplier's Declaration of Conformity

Issuer: Husqvarna AB, Drottninggatan 2, S-561 82 Huskvarna, Sweden www.husqvarnagroup.com.

Responsible party: Husqvarna Professional Products, Inc. 9335 Harris Corners Parkway Suite 500 Charlotte, NC 28269 United States U.S. Contact information: Michael Campbell, Sr Director Quality, test compliance, Telephone: +1 704 597 5000.

10.2 Compliance requirements

FCC ID: MCQ-XBSX (Short range device 915 MHz).

FCC ID ZASHQ-BLE-1G (Bluetooth® module).

FCC ID: XPYUBX18ZO01 (Automower® Connect 2G/4G).

The Bluetooth® module is located on the HMI-board (PCBA) in the upper chassis. All circuit boards in the mower using radio are located in the upper chassis. They must only be accessed by an authorized service technician.

harmful interference to radio or television reception, which can be determined by turning the equipment off and on, the user is encouraged to try to correct the interference by one or more of the following measures:

- Reorient or relocate the receiving antenna.
- Increase the separation between the equipment and receiver.
- Connect the equipment into an outlet on a circuit different from that to which the receiver is connected.
- Consult the dealer or an experienced radio/TV technician for help.



WARNING: Cancer and Reproductive Harm - www.P65Warnings.ca.gov.



WARNING: To comply with RF exposure requirements, please maintain a separation distance of at least 20 cm/7 inches from any part of the product.

Note: Changes or modifications made to this equipment not expressly approved by Husqvarna may void the FCC authorization to operate this equipment.

Note: This device complies with Part 15 of the FCC Rules [and with Industry Canada licence-exempt RSS standard(s)]. Operation is subject to the following two conditions: this device may not cause harmful interference, and this device must accept any interference received, including interference that may cause undesired operation.

Note: This equipment has been tested and found to comply with the limits for a Class B digital device, pursuant to part 15 of the FCC Rules. These limits are designed to provide reasonable protection against harmful interference in a residential installation. This equipment generates, uses and can radiate radio frequency energy and, if not installed and used in accordance with the instructions, may cause harmful interference to radio communications. However, there is no guarantee that interference will not occur in a particular installation. If this equipment does cause



Husqvarna[®]

AUTOMOWER[®] is a trademark owned by Husqvarna AB.
Copyright[®] 2021 HUSQVARNA. All rights reserved.

www.husqvarna.com

Original instructions

1142663-95



2021-01-14