



Auto Mower

Operator's Manual



Please read through this Operator's Manual carefully and understand its contents before using the Auto Mower.

We congratulate you in becoming a new owner of a Husqvarna Auto Mower. You have chosen a product that we hope will fulfil and even exceed the expectations you have a right to demand. Automatic lawn mowing is a new step in development, which involves a new way of thinking and behaviour, not least from the consumer himself.

The Auto Mower is in many ways a revolutionary product. It allows you to have a well-kept lawn throughout the season with a minimum of inspection and maintenance.

The document that you are now holding in your hand, the Operator's Manual, is an important part of your future interaction with the Husqvarna Auto Mower.

We know that an Operator's Manual is normally seen as boring and complicated and therefore has a tendency to be left unread. With this machine it will be difficult to properly operate it without this documentation. Therefore our first suggestion is:

– To read this Operator's Manual and save it for future use. In addition to the instructions normally provided in a Operator's Manual, for example warnings, safety instructions and maintenance instructions, we also provide a comprehensive description of how the Auto Mower “thinks” and works. There are also installation instructions for different types of lawns and a simple trouble shooting chart. We hope that this will help you to gain as much as possible from your new product.

If you have any questions or thoughts not answered in this document you are always welcome to contact your dealer. We hope that you get immense enjoyment from your new Auto Mower. Good luck!

Husqvarna AB Sweden

Lars Andersson
Business Manager Automatic Lawn mowers

Please visit us on the Internet:

www.automower.com

www.husqvarna.com

SYMBOL EXPLANATION/LIST OF CONTENTS

Symbols on the Auto Mower



IMPORTANT!
Read through the Operator's Manual carefully and make sure you understand it before you start to use the Auto Mower.



WARNING!
Keep children out of mowing area while Auto Mower is in operation.



WARNING!
This tool can be dangerous if used incorrectly. The warnings and safety instructions in the Operator's Manual must be followed carefully for the Auto Mower to be used safely and efficiently.



WARNING!
There are rotating blades under the Auto Mower. Never put your hands or feet close to or under the body of the Auto Mower while it is running.



This product conforms to the applicable EU Directives.



Stop the Auto Mower by lifting its cover.

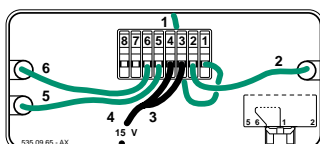

Connection instructions, charging station.

Symbols in the Operator's Manual

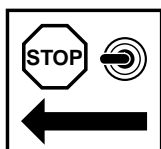

Inspection and/or maintenance should be carried out with the Auto Mower power switch set to "STOP".

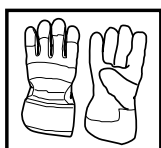

Always wear protective gloves when working with the blades or cutting disc.

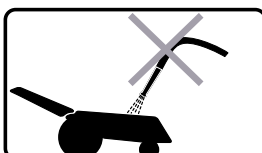

Never use a high-pressure jet or even running water to clean the Auto Mower.

List of contents

Symbol explanation

Symbols on the Auto Mower	1
Symbols in the Operator's Manual	1

Safety guidelines and information

Use	2
Transport	2
Care	2

Special safety features

Tilt sensor	3
Lift sensor	3
Collision sensor	3

Parts of the Auto Mower

What is what?	4
---------------------	---

Function

Technical data	5
Charging station	5
Loop wires	5
Auto Mower	5

Installation

Planning the installation	6
Installation of the charging station	7
Installation of boundary wire	8
Installation of search loop	9
Installation, step by step	11

Use

Start and stop	12
Adjusting the cutting height	12
Charging an empty battery	13
Settings	14
Sound and lamp indications	16

Maintenance

Replacing the blades	17
Battery	17
Winter storage	17
Cleaning	17

Trouble shooting

Trouble shooting chart	18
------------------------------	----

Owner information

Owner information	20
-------------------------	----



WARNING!

Under no circumstances may the original design of the Auto Mower be modified without the permission of the manufacturer. Always use genuine spare parts. Unauthorized modifications and/or components can result in serious disruptions and the risk of personal injury.



SAFETY GUIDELINES AND INFORMATION

Use

- Read through the Operator's Manual carefully and make sure you understand its contents before using the Auto Mower.
- Read and follow instructions on mower and in owners manual.
- Keep children out of mowing area while Auto Mower is in operation.
- Keep hands and feet away from cutting deck and mowing parts.
- Remove objects that could be thrown by the blades.
- Check that there are no stones, twigs, tools, toys or other objects on the lawn that can damage the blades or cause the mower to stop.
- Start the Auto Mower in accordance with the instructions. Keep your hands and feet away from the rotating blades. Never put your hands or feet underneath the mower.
- Make sure that no one is standing in front of the Auto Mower when you start it.
- Never lift up the Auto Mower or carry it around when it is running.
- Do not let persons who do not know how the Auto Mower works and behaves use the mower.
- Do not put anything on top of the Auto Mower or its charging station.
- Do not allow the Auto Mower to be used if any part is seen to be defective or faulty. This includes the cutting disc, blades, nuts, bolts and cables.
- Do not use the Auto Mower if the power switch does not work.
- Always switch off the Auto Mower by means of the power switch when it is not in use.

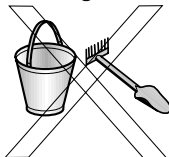

Starting the Auto Mower

The battery must be charged before starting when the Auto Mower is new or has been stored for a long period, see "Charging an empty battery". In other cases the Auto Mower can be started at any time within the mowing area, according to the following:

- Lift the cover and switch on the switch. A long beep should be heard.
- Enter your personal code, * **code #**. On delivery the code is * **0000 #**, see the "Settings" section to select your personal code.
- Lower the cover. The Auto Mower will either immediately start to mow or seek out the charging station. If the Auto Mower travels to the charging station with a fully charged battery it will leave after a short while. If the battery needs to be charged, it will remain there for sometime before leaving the charging station.

Stopping the Auto Mower

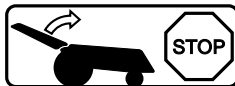

- Stop the Auto Mower by lifting up the rear cover. Enter the first digit of the code to deactivate the theft alarm. Otherwise the alarm will sound after approx. 6 seconds. The long beep heard after lifting the rear cover confirms that cutting disc has stopped.
- Restart the Auto Mower by lowering the rear cover again.
- Always set the power switch to "STOP" if you intend to carry out any maintenance on the Auto Mower or to move it outside of the mowing area. When the switch is flipped to on, the personal code, ***code #**, must be entered.

Transport



WARNING!

Never move the Auto Mower with the cover lowered. The blades can then rotate and cause personal injury.

Moving the Auto Mower from or within the mowing area:

1. Lift the cover. The long beep after the cover has been lifted indicates that the cutting disc has stopped.
2. Enter the first digit of your personal code to prevent the theft alarm being activated.
3. Switch off the power switch if the Auto Mower is to be moved outside of the mowing area. Otherwise this does not need to be switched off.
4. Carry the Auto Mower by its handle.

Pack away the Auto Mower in the original packaging or in the Husqvarna Auto Mower storage bag when transporting over long distances.

Care

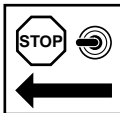

- Inspect the Auto Mower weekly and replace any damaged parts. Check in particular that the cutting disc and blades are not damaged. Change all the blades at the same time if replacement is necessary so that the rotating parts are balanced, see the "Maintenance" section.
- Clean the charging station's contact plates and the Auto Mower's charging pins using a fine abrasive cloth if necessary. If black oxide forms on the Auto Mower's charging pins this can be a sign of inferior electrical contact between the charging pins and the charging station's contact plates. Check the installation of the charging station, refer to "Installation, step by step". Always check whether cleaning is necessary with the first usage after the winter break.
- Contact your local dealer when changing damaged or worn parts.
- Old batteries that have been replaced should be returned for disposal to your dealer or to a recycling station.



WARNING!

The power switch must be switched off with all work on the mower's chassis such as cleaning, setting the cutting height or replacing the blades. The power switch must always be switched off when the machine is turned upside down. If the mower's start-up signal has been switched off you will not hear beeps warning for the start of the cutting disc (5 beeps during 5 seconds).

SPECIAL SAFETY FEATURES

Tilt Sensor

The tilt sensor is located in the rear chassis of the mower. In the event that the mower is not properly shut down by raising the rear cover, and the mower is lifted from the rear of the machine or is inadvertently elevated from the front, the blade motor will automatically shut down, stopping the rotation of the cutting blades. Only when the mower is returned to its normal level position will the machine attempt to re-start after approximately 20 seconds.

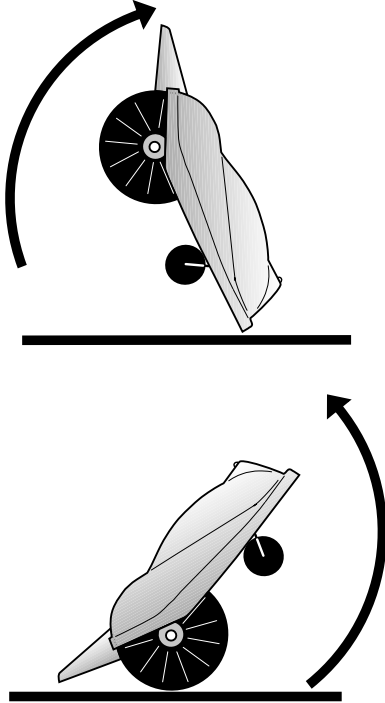

Lift Sensor

The lift sensor is located under the front nose of the machine. In the event that the mower is not properly shut down by raising the rear cover, and an attempt is made to lift the machine off the ground by any outer section of the body, the blade motor will automatically shut down, stopping the rotation of the cutting blades. Only when the mower is returned to its normal position will the machine attempt to re-start after approximately 20 seconds.

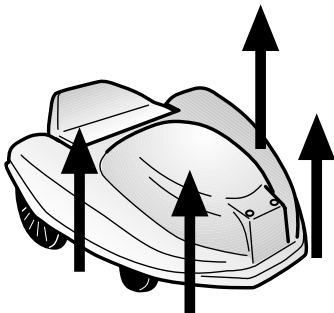

Collision Sensors

The collision sensors are located adjacent to the rear wheels and is the attaching point of the body to the frame. If the machine bumps into to any firm or solid object in the zone marked --- during the course of its normal forward movement, the machine will stop its forward movement, back up and turn left or right, then resume forward movement.

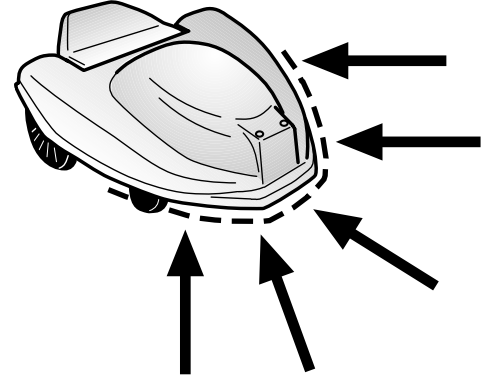

PARTS OF THE AUTO MOWER

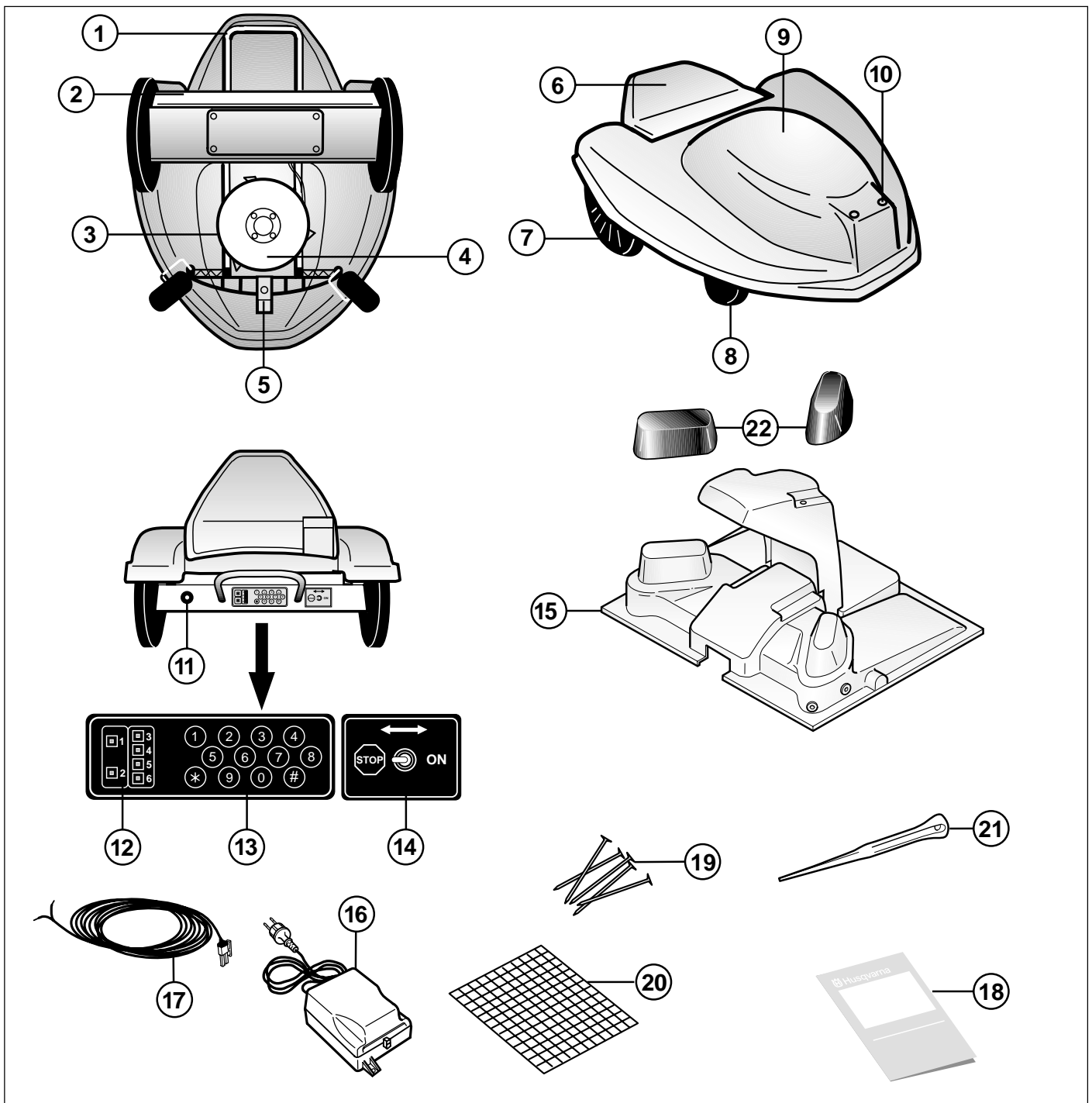

What is what?

1. Handle and cover rest
2. Box containing computer, battery and wheel motors
3. Cutting disc
4. Protective disc
5. Loop sensor
6. Hinged cover
7. Drive wheel
8. Front wheel
9. Body
10. Charging pins
11. Buzzer

12. LEDs (light-emitting diodes)
13. Keypad
14. Power switch
15. Charging station
16. Transformer with mains power cable
17. Low-voltage cable
18. Operator's Manual
19. Nails for docking unit
20. Mesh for charging station
21. Tool for connecting wires to charging station
22. Protective covers for charging station docking tower

FUNCTION

Technical data

Battery	NiMH special battery, 12 V
Mowing system	Cutting disc with three pivoting blades
Cutting height	Variable adjustment, approx. 3–9 cm/ 1.2-3.5"
Weight	7.1 kg/15.6 lbs
Length	72 cm/28"
Width	60 cm/23.6"
Height	26 cm/10.2"
Cutting width	22 cm/8.7"
Working capacity	1650 m ² /18 000 ft ² ± 20%
Charging station	15 V / 2.5 A
Transformer	115 / 15 Volt, double-insulated

Charging station

The charging station has two tasks. It charges the Auto Mower's battery when necessary, and also sends control signals along the search wire and boundary wires. The charging station is connected to a wall socket via the supplied cable and transformer.

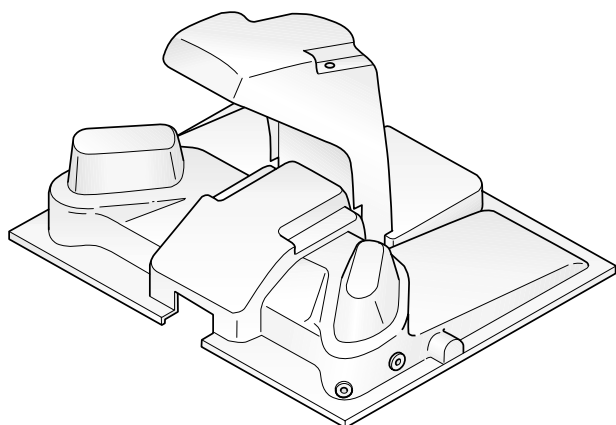

Loop wires

Two separate loop wires have to be laid out, a boundary wire and a search wire. The boundary wire runs round the edge of the Auto Mower's working area, and the search wire guides the Auto Mower to the charging station. Signals transmitted from these two wires are received by the Auto Mower's sensor.

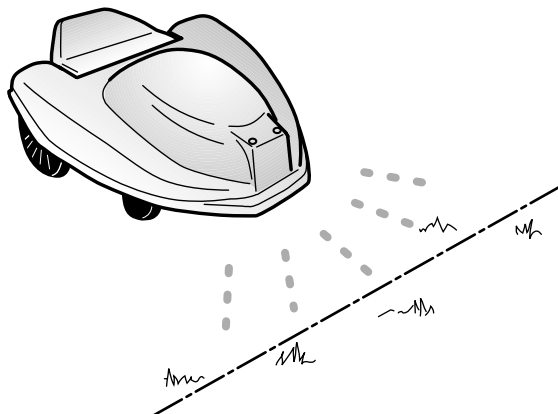

Auto Mower

Operating principle

The Auto Mower mows your lawn automatically. When its battery runs down it moves to its charging station to recharge. When the battery is fully charged, the Auto Mower starts mowing again.

The Auto Mower is controlled by a built-in computer that consists of a circuit board with a microprocessor. The computer is the Auto Mower's "brain" and handles all of its functions, commands and path selection by means of the data gathered via the keypad, sensor and battery charging status.

Movement pattern

The Auto Mower always starts its work in accordance with the random principle, i.e. the starting path is unplanned. Each time it hits an obstacle or senses the signal from the boundary wire, the computer chooses a new direction. This is designed so that the Auto Mower never regularly repeats the same movement pattern.

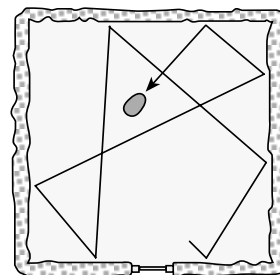

If the Auto Mower enters an area where it senses that the grass is longer than where it has just been, it can start to mow systematically. It then mows in a spiral pattern, mowing the area that has longer grass than the surrounding area. After this it returns to the random principle.

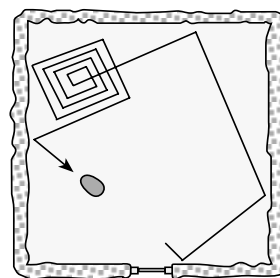

Initially the Auto Mower works for a few hours to get an idea of the average length and thickness of the grass. Only then does it start working systematically.

When the front of the Auto Mower bumps into an obstacle it backs away and chooses a new direction.

When the Auto Mower needs to charge its battery it follows the search wire that leads it to the charging station. If the battery doesn't need charging the Auto Mower ignores the search wire.

Working capacity

The Auto Mower can cut about 100 m² (1100 ft²) per hour when operating and is recommended for grass areas of up to approx. 1650 m²/18 000 ft² ± 20%.

The size of the area that the Auto Mower can mow depends partly on the shape of the garden. If the working area consists of an open lawn, this generally means that the Auto Mower can mow a larger area than if the working area consists of several grass areas or one that has many trees, flower beds or the like.

The length of time the Auto Mower spends mowing and recharging can vary, and depends partly on the temperature.

INSTALLATION

Planning the installation

To get a good mowing result, you must install the charging station and boundary wires carefully. Read through the whole of this section before you begin the installation.

When the Auto Mower is released into the working area the length of the grass should not be more than 1–2 centimetres (1/3-1/2") longer than the set cutting height, especially if the working area is large. It may be necessary to cut the grass using a traditional lawn mower before using the Auto Mower for the first time. The Auto Mower will then prevent the grass from growing long.

The boundary wire is laid so that it frames in the Auto Mower's working area. The loop can also be used to exclude areas within the working area.

The search wire is laid inside the working area. When it is time to recharge the battery the Auto Mower will start to search for the search wire.

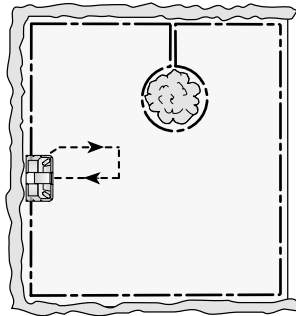

The boundary wire must be no longer than 500 meters (1640 ft). The distance between the Auto Mower and the nearest part of the boundary wire must not exceed 35 meters (115 ft) anywhere in the working area.

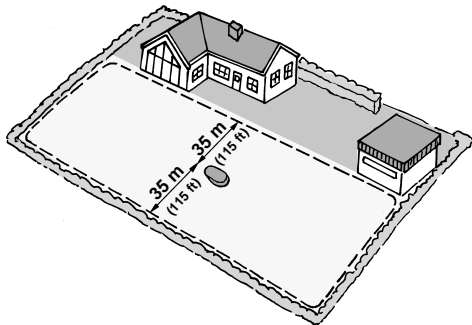

When the Auto Mower's working area borders, e.g. collections of water, driveways and pathways, etc. the boundary wire must be supplemented with a number of posts, edging or a fence with a height of at least 15 cm (6"). This is an additional safety measure to prevent the Auto Mower from running outside of its working area.

Placing the charging station

When you decide where to put the charging station, it is important to consider how the power supply will be arranged. The charging station is connected to the transformer via the supplied 20 meters (65 ft) long low-voltage cable. The transformer should be placed in a weather-protected location, if possible indoors, and is connected to a 115 Volt standard household receptacle. If placed outdoors, the transformer should be placed horizontally and at least 0,5 meters (20") above the ground. The transformer must never be exposed to dampness. Use only the Husqvarna original low-voltage cable and transformer.

The most suitable location for the charging station is at the outer edge of the working area. Exactly where depends on the shape of the garden. If the working area consists of several smaller areas that are separate and joined by pathways, it is best to put the charging station as central as possible. The search wire must also be laid so that the final metre before the charging station is straight. The area under and in front of the charging station must be flat and level.

The accompanying mesh should be placed underneath and in front of the charging station. It reduces wear to the lawn and gives the Auto Mower a firm base to ensure reliable charging. See the illustrations below for examples of search wire installations.

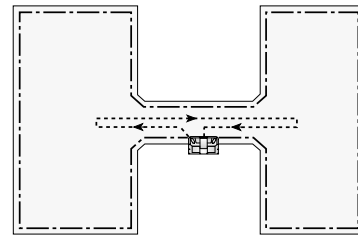
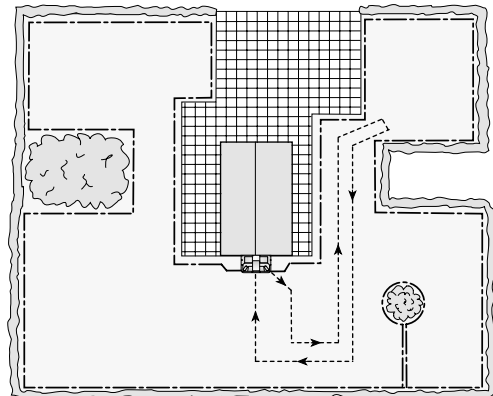
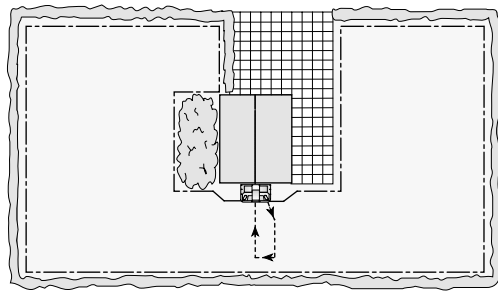

The area in front of the charging station should be as open as possible. Don't put the charging station in a "pocket". We recommend that the charging station is placed somewhere along a straight part of the boundary wire rather than in a corner.

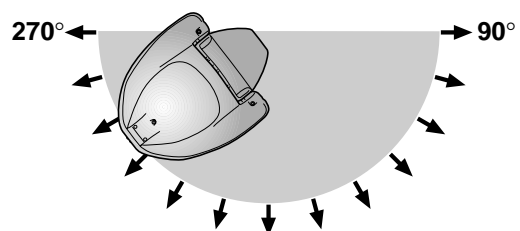
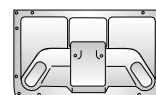
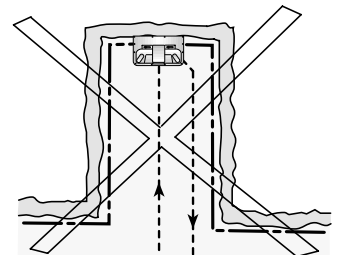

The mower normally leaves the charging station at a random angle within the range 90–270° (see diagram).

INSTALLATION

If the charging station has to be placed in a passage, the grass in the passage around the charging station could be mown too often. To avoid this the Auto Mower can be programmed to leave the charging station in any chosen direction within the range 45–315°. You simply enter the angles between which you want the mower to leave the charging station. See the chapter on “Use” (Leaving the charging station).

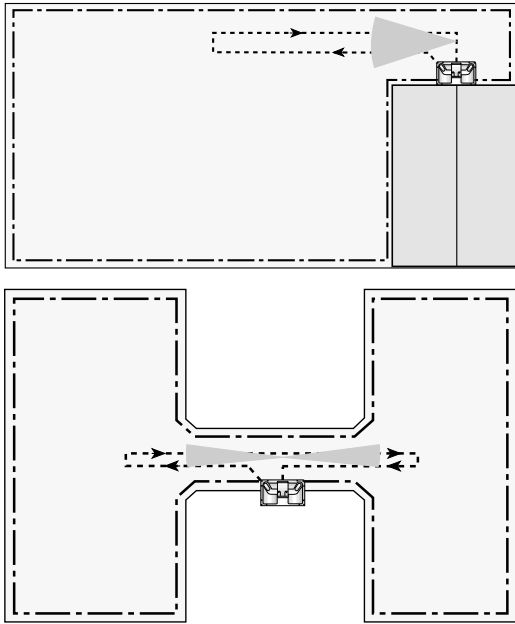

It is beneficial to place the charging station in the shade if possible, when operated in areas with a hot climate.

Separate working areas

It may be a good idea to lay out more than one separate working area in certain cases:

- When lawn areas are not joined to each other.
- When one area is much smaller than another and the only link is through a narrow passage.

The charging station and the search wire must be located in the main area, i.e. the largest working area. The boundary wire is then laid in accordance with the installation instructions, along the outer edge of the Auto Mower’s working area, see “Installation of boundary wire”. The secondary area or areas are created by laying the boundary wire in the form of an “island” outside the working area. See the illustration.

The Auto Mower must then be moved by hand between the various working areas, since automatic battery charging can only be carried out while the Auto Mower is in the main area. To facilitate the manual work see the chapter, “Settings” (Mowing secondary areas).

When the battery is fully charged the Auto Mower can mow for about 2-3 hours or 200-300 m² (650-1000 ft), depending on the age of the battery and the length of the grass.

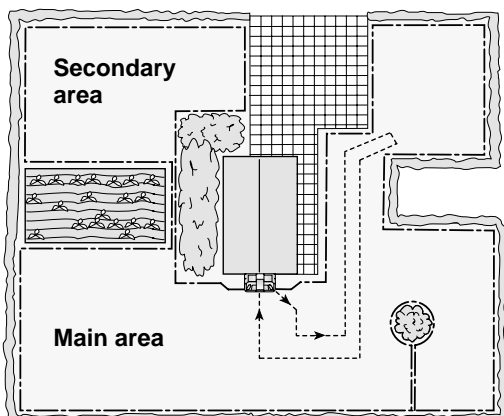

Installation of the charging station

Secure the charging station to the ground using the six nails supplied.

The boundary wire and search wire should be routed through the wire channels in the charging station so that they exit by the terminal block at the rear. The low-voltage cable is led out backwards from the terminal block through the hole in the cover.

The incoming search wire (connect to terminal 1) should be routed through one of the four wire channels at the front of the charging station. For most installations the first or second slot from the left usually provides the most effective docking (see drawing).

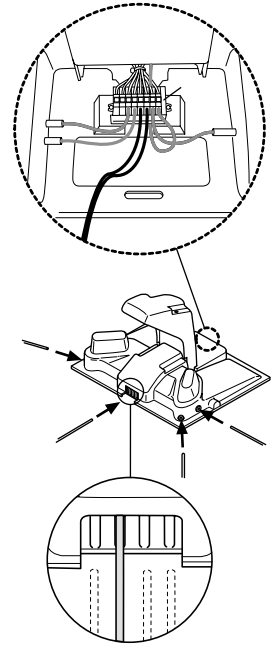

To ensure correct docking and charging of the battery it is important that the charging station is installed as follows:

- The charging station must not stand on an upslope (fig. 1).
- The charging station must be level in relation to the mower (fig. 2).
- The charging station must be on level ground (fig. 3).

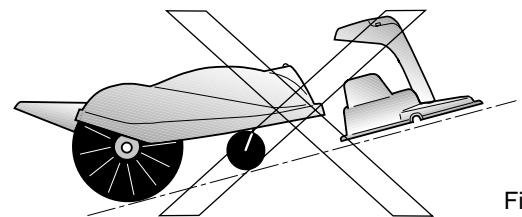

Fig.1

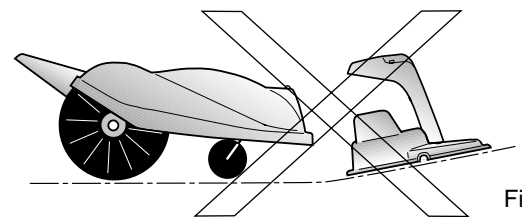

Fig.2

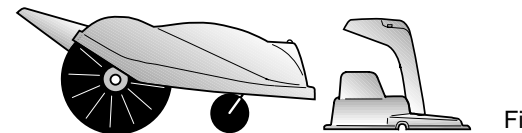
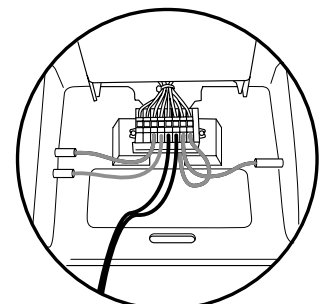

Fig.3

There is a terminal block at the rear. The low voltage cable, the search wire and the boundary wire should be connected to the terminal block. See “Installation, step by step”.



INSTALLATION

There is a toggle switch on the charging station for testing. A continuous beep when the switch is switched on indicates that the charging station is receiving power and that the search and boundary wires are connected. A series of beeps indicates that the charging station is receiving power, but the search or boundary wires or both are disconnected or broken.

There should be two free zones of 40 cm (16") on both short sides of the charging station to provide optimal operation. Accordingly, the boundary wires should run from the charging station in line with its outer edges.

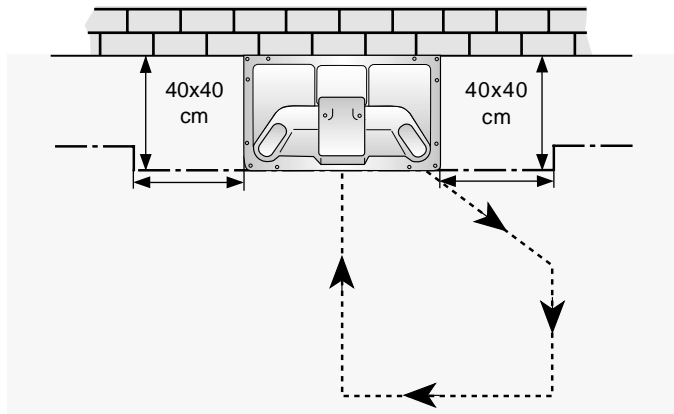

Installation of boundary wire

The boundary wire must be laid along the outer edge of the Auto Mower's working area.

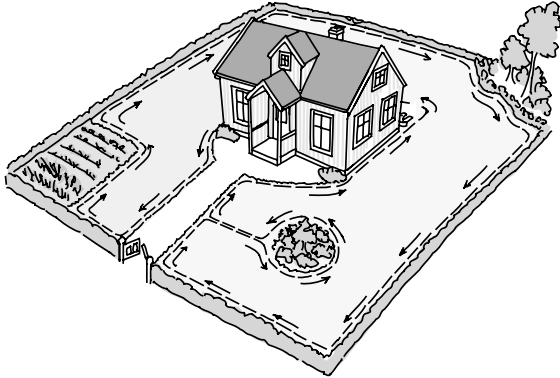

When the Auto Mower reaches the boundary wire it senses that it is passing the wire. It then continues for a short distance beyond the wire before reversing.

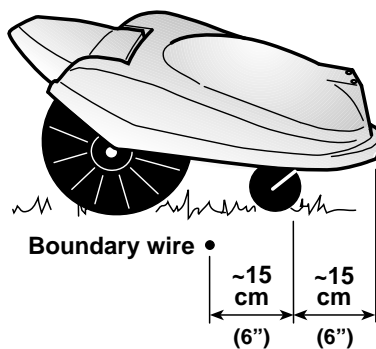

How far inside the outer edge of the working area the boundary wire should be placed depends on what lies immediately outside the area. If there is a high obstacle, such as a wall or fence, or delicate flowers, just outside the area to be mown, the boundary wire should be laid 40 cm (16") from the obstacle. This should prevent the Auto Mower bumping into it.

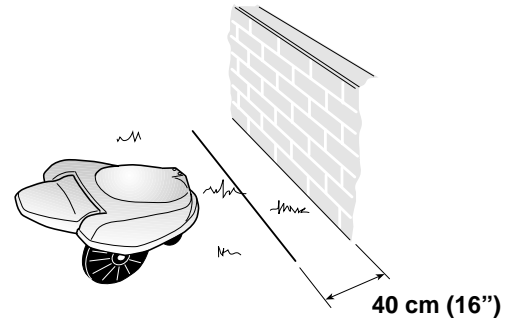

Where the lawn finishes with a ditch or a small rise, such as curb stones (max. 5 cm/1 1/8" high), lay the boundary wire 30 cm (12") inside the edge of the working area. This ensures that the wheels will not fall into the ditch or ride up on the curb stones.

If the lawn slopes down toward the boundary wire this distance must be increased by 5–10 cm (2–4") because of the slope.

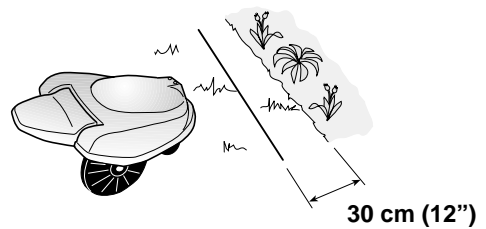

Where a path has been laid at the same level as the lawn, it is possible to allow the Auto Mower to drive a little way on to the path and cut the grass right up to the edge. In this case, lay the boundary wire about 10 cm (4") from the edge of the path.

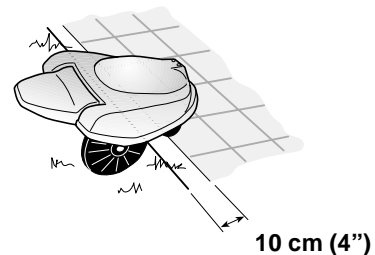

Long narrow passages (more than 2 meters/6 1/2 ft in length) should be at least 2 m (6 1/2 ft) wide, i.e. leaving 140 cm (55") between the wires, to give the Auto Mower enough space to make its way through. See the illustration. Shorter passages (less than 1 meter/39 inches long) should be at least 1,2 m (39 inches) wide.

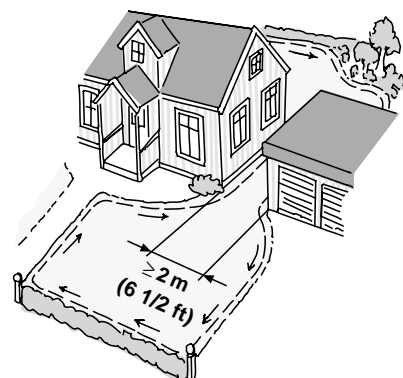

INSTALLATION

The Auto Mower can mow areas with an incline of up to around 15° (27 cm difference in height per metre). Steeper areas must be cordoned off with the boundary wire. If the optional weights are fitted (article number 535 09 11-01, the mower can tackle inclines slightly steeper than 15°. You should however avoid laying the boundary wire on a downslope. When the grass is wet the mower may slip if the slope is too steep, and it might have problems reversing when it reaches the wire.

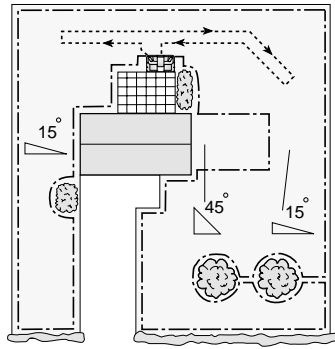

Lay out the boundary wire and secure it to the ground using staples so that there is no risk of the blades cutting the cable. Allow the Auto Mower to work for a week and then decide whether any adjustments to the wire routing are necessary. After a few weeks the grass will have "weaved in" the cable so that it is not visible. The boundary cable can also be laid from 2-5 cm (7/8-2") to a maximum of 20 cm (7 1/2") under the soil.

Metallic objects can interfere with the boundary signal. The boundary wire should not be routed too close to iron fences or metal manhole covers. In most cases it is sufficient to lay the boundary wire 30 cm (12") from these types of object. However, in some cases, such as electric fences, the distance may need to be greater. If the Auto Mower regularly stops at a certain point on the lawn and indicates that there is no signal from the wire (LED 6 is on), this is probably due to this kind of interference.

If the boundary wire needs to be joined this must be done so that the joint is waterproof. The best contact is obtained if the joint is made using Husqvarna's solder-free connector, item number 535 04 43-01. The joint can also be soldered and then insulated using shrink tube.

NOTE! Twisted cable ends or a single screw terminal block, insulated with insulation tape are not satisfactory joints. Ground moisture will cause the conductors to oxidize and after a period of time this will result in a broken circuit.

Excluding areas inside the working area

If you wish, you can keep the Auto Mower away from certain areas within the cutting area, such as flowerbeds, fountains etc. Route the boundary wire out to the section, around the section and then back along the same route as the boundary wire was taken out. The same instructions also apply when the boundary wire is being taken out to an area that lies outside the first excluded working area. The wires should be laid adjacent to each other. If the wires are stapled, they should be placed under the same staples.

NOTE! It is very important to route the inbound and outbound boundary wire in the correct direction around each section, so that the inbound is always on the first installed side and the outbound is always on the opposite side.

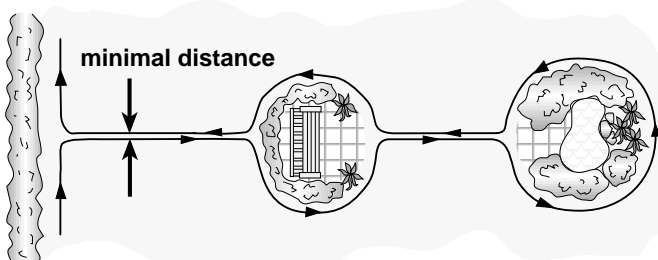

Trees, bushes and the like that can withstand the Auto Mower pushing against them do not need to be screened off by the boundary wire. The Auto Mower will reverse anyway when it hits an obstacle. However, these obstacles must be higher than the front edge of the chassis, which means about 10 cm (4") or more. Similarly, obstacles with a gentle slope, for example stones or large trees with protruding roots, should be either screened off or removed. Otherwise the Auto Mower can climb up on such obstacles and probably damage its blades.

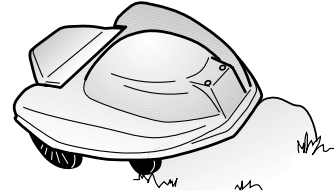

Installation of search loop

When it's time to charge the battery, the Auto Mower begins to look for the search wire. Once the Auto Mower has detected that it has crossed the search wire, it follows the wire in a clockwise direction until it reaches the docking side of the charging station. Searching for the search wire begins when there is enough charge left in the battery for another hour or two of running time. At some time during this period the Auto Mower must therefore find the search wire. If the Auto Mower has plenty of charge left in its battery, it will ignore the search wire.

The search wire must be laid from the charging station clockwise around but inside the working area and then back to the charging station. If the working area consists of several sections that are joined to each other by long narrow passages, the search wire must be laid so that it goes into each area. See "Planning installation" for examples.

The search wire must never go outside the working area or cross over itself.

Passages and wire separation distance

Lay the search wire as straight as possible. Make sharp corners wherever the wire needs to turn. Refer to "Installation of boundary wire" for advice on possible signal interference from the surroundings.

The search wire should be laid so that its wires are at least 70 cm (28") from each other and from the boundary wire, see the illustration. In exceptional cases and along short stretches, e.g. to be able to enter a narrow passage, or for the final 4 feet leading to the charging station, the wire lengths are allowed to lie closer to each other. The search wire may even be laid across the two parts of the boundary wire that approach and return from an "island".

The outgoing search wire from the charging station should lie at an angle of 45° to the boundary wire, see the illustration. The final 4 feet of the incoming wire must go straight into the charging station, see the illustration.

NOTE! The search wire loop should form a long and narrow corridor-like shape. Don't lay the wire lengths further than 2 m (6 1/2 ft) apart.

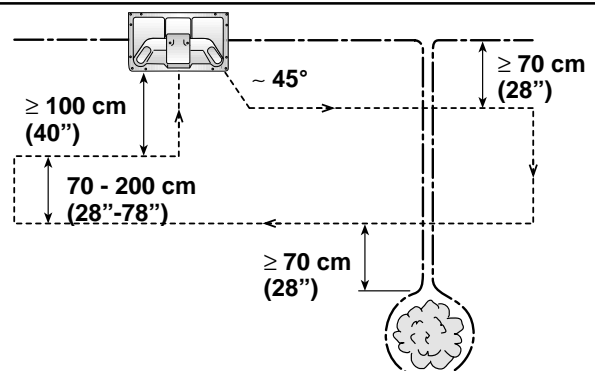

INSTALLATION

In exceptional cases and over short distances the wires can be laid closer together, i.e. in a narrow passageway or in the final 4 feet approach to the charging station. If so, it is important that the wires are equally spaced.

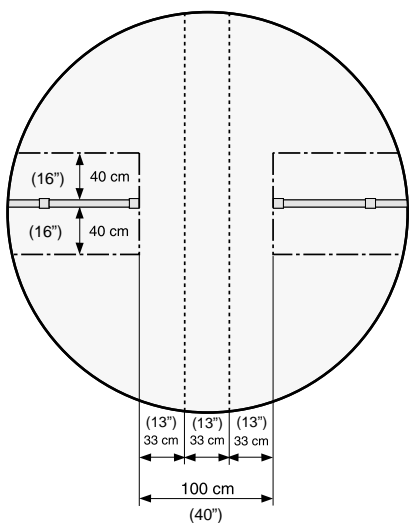

Since the Auto Mower follows the path of the search wire, it must be laid at least 40 cm (16 inches) away from any obstacle to prevent the Auto Mower from bumping into anything on its way to the charging station.

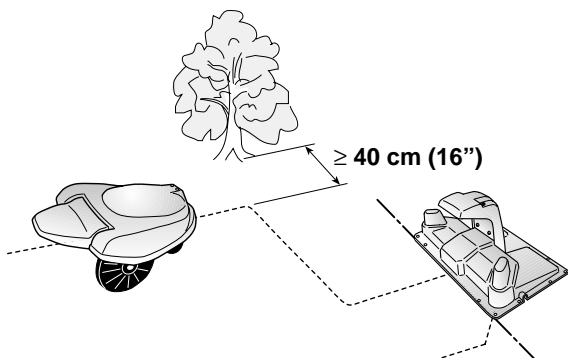

INSTALLATION

Installation, step by step

The wires must be connected to the docking unit terminal block as shown in this wiring diagram when steps 3-12 in these installation instructions are performed.

Use the tool supplied to connect the six wires to the terminal block. See drawing.

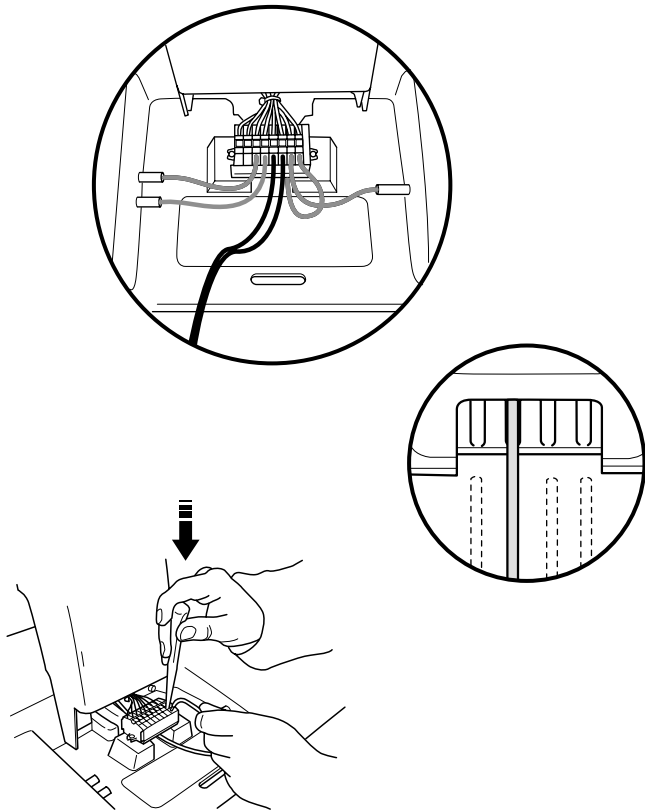

NOTE! Do not let any metal objects touch the charging station contact plates while the transformer power cable is plugged into the receptacle. This can cause the plates to short-circuit and the transformer fuse will blow. There is no risk of harmful electric shock from the 15 V low-voltage supply.

1. Select the placement for the charging station as set out in "Planing the installation".
2. Position the charging station and secure it to the ground using the six nails supplied.
3. Strip both conductors on the low-voltage cable and connect to positions 3 and 4 on the charging station terminal block. It does not matter which of the conductors that are connected to terminals 3 and 4.
4. Run the low voltage cable to the transformer. Insert the low voltage cable connector in the transformer. Connect the transformer's power cable to a 115 V standard receptacle.
5. As power is supplied to the charging station you can charge the Auto Mower while the boundary wire and search wire are being installed. Place the mower in the charging station with the ON/STOP switch set to STOP for around 1 hour. Then lift the cover, set the switch to ON, enter the code * 0000 # and close the cover. See also "Charging an empty battery". The first charge takes a few hours. If the Auto Mower leaves the charging station before the boundary wire has been installed completely, it will stop in front of the charging station and alarm "sense no signal from the wire". This alarm will stop automatically when the boundary wire is connected. You can also switch off the Auto Mower's alarm by lifting the cover and entering the first digit of the code.

6. Install the boundary wire as set out in the description, see "Installation of the boundary wire". Wait to connect the cable ends.
7. Install the search wire as set out in the description "Installation of the search wire". Wait to connect the cable ends.
8. If the Auto Mower is in the charging station – lift up the rear, enter the first digit of the code and move the mower from the charging station.
9. Lay the boundary wires in the wire channels. Trim the wires, strip the insulation and connect to terminals 2 and 5, as shown in the wiring diagram on the left.
10. Lay one search wire in the wire channel, as shown in the wiring diagram on the left, strip the insulation and connect to terminal 6.
11. Lay the other search wire in one of the four slots available at the front of the charging station (see drawing on left). For most installations one of the two wire channels on the left is most suitable. Strip the wire and connect to terminal 1. Now place the Auto Mower at right angles to the search wire, a couple of metres from the charging station, and key in the command * 31 #.

Check whether the Auto Mower's contact pins line up roughly with the centres of the contact plates when it docks with the charging station. If they are not aligned with the contact plates then you should disconnect the incoming search wire from terminal 1 and route it through one of the other wire channels. Repeat the docking operation three or four times to ensure that the Auto Mower docks correctly with the charging station each time.

If the Auto Mower stops immediately and gives three beeps when you key in the command * 31 #, and LED 4 flashes or LED 6 glows steadily, then the wires have been connected incorrectly. If this happens go back to steps 9 and 10 and check that the installation is correct.

12. Make sure the surface in front of the charging station is completely flat, so that both of the Auto Mower's charging pins make good contact with the charging station's contact plates. Adjust the charging station vertically if necessary. See drawing below.

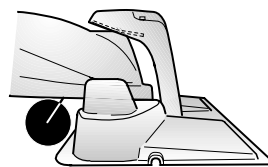

Staple the mesh securely to the lawn in front of the charging station. It reduces compaction and wear to the lawn, which could lead to problems with charging and Auto Mower operation.

Use the switch on the charging station to check the boundary wire.

- A continuous beep means that the search and boundary wires are not broken.
- An series of beeps means incorrect installation or a break in the search or boundary wire. Ensure that the search and boundary wires have been laid in accordance with the installation instructions, or repair the break in the wire.
- If no beep is heard there is no power supply to the charging station.

USE

Start and stop



WARNING!
There are rotating blades under the Auto Mower. Never put your hands or feet close to or under the body of the Auto Mower while the motor is running.



WARNING!
Read carefully through the safety regulations in this Operator's Manual before you start the Auto Mower.

Starting the Auto Mower

The battery must be charged before starting when the Auto Mower is new or has been stored for a long period, see "Charging an empty battery". In other cases the Auto Mower can be started at any time within the mowing area, according to the following:

- Lift the cover and switch on the switch. A long beep should be heard.
- Enter your personal code, * **code #**. On delivery the code is * **0000 #**, see the "Settings" section to select your personal code.
- Lower the cover. The Auto Mower will either immediately start to mow or seek out the charging station. If the Auto Mower travels to the charging station with a fully charged battery it will leave after a short while. If the battery needs to be charged, it will remain there for sometime before leaving the charging station.

Stopping the Auto Mower



- Stop the Auto Mower by lifting up the rear cover. Enter the first digit of the code to deactivate the theft alarm. Otherwise the alarm will sound after approx. 6 seconds. The long beep heard after lifting the rear cover confirms that cutting disc has stopped.
- Restart the Auto Mower by lowering the rear cover again.
- Always set the power switch to "STOP" if you intend to carry out any maintenance on the Auto Mower or to move it outside of the mowing area. When the switch is flipped to on, the personal code, * **code #**, must be entered.

Adjusting the cutting height

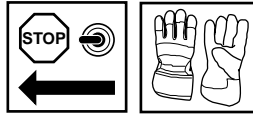

The cutting height can be adjusted to any height between around 3 cm (setting 1) and 9 cm (setting 5) (1 1/4" and 3.5"), which is roughly equivalent to 4–10 cm (1.5-4") for a conventional and heavier gasoline powered mower.

- Switch off the Auto Mower by lifting the cover, entering the first code digit of the code and switching off the switch.
- Turn the Auto Mower upside down and place it on a soft surface.
- Unscrew and loosen the height adjustment knobs to adjust the cutting height. Move the entire cutting motor up or down until the desired cutting height is reached. Then re-tighten the adjustment knobs.

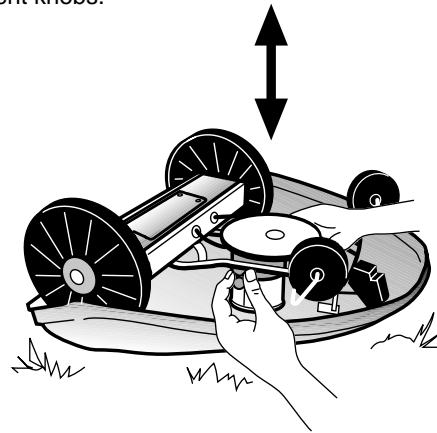

Charging an empty battery

These instructions apply when Auto Mower is new, or after a long period of storage.

If the Auto Mower has been used recently it does not need to be started in the charging station, see the chapter "Start and stop".

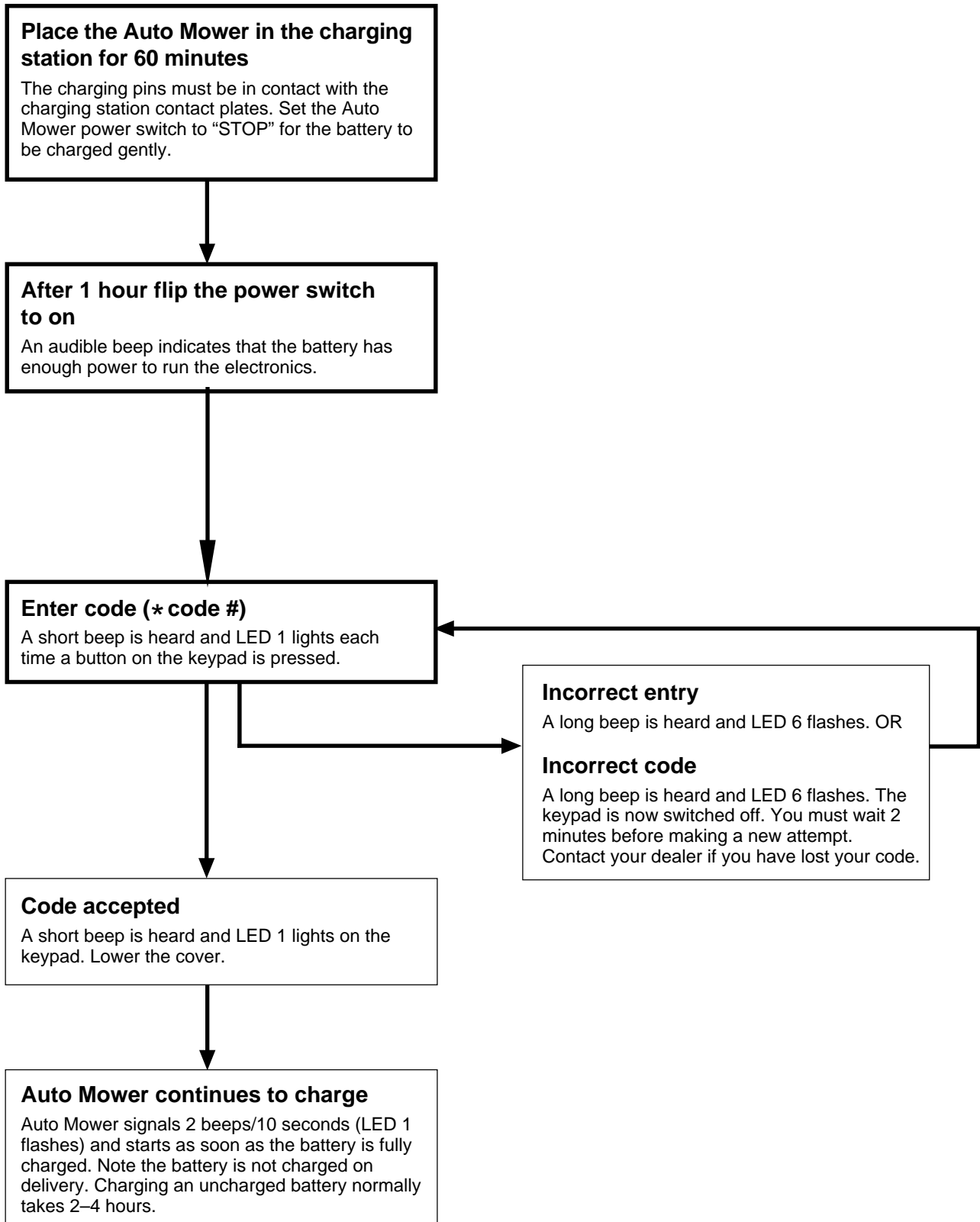

Settings

The keypad is used to deactivate the theft alarm, enter the security code and to change some of the Auto Mower's settings.

If you have started to enter a value by pressing buttons on the keypad and wish to cancel the input, press *.

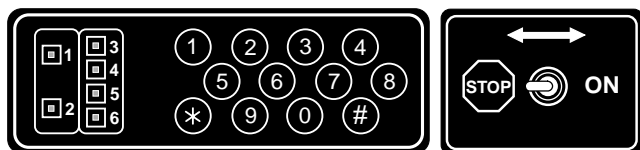

Resetting the values

Pressing * 21 # resets everything back to the settings the Auto Mower had when it was delivered. However, your personal code will not be changed.

Basic setting

You can simplify the operation of the mower by entering * 9 # * code #. This switches off the theft alarm, so there is no need to enter the first digit of the code when you lift the rear cover. This also switches off all audible signals, except the start-up beep.

Selecting a personal code

You have to enter a code into your Auto Mower for it to start working. On delivery the code is set to * 0000 #. It is possible and it is recommended that should select your own personal code. Think of a code with four digits and then enter it using the keypad as follows:

* current code # new code # new code #

Example: * 0000 # 1234 # 1234 # changes from code 0000 to 1234. LED # 1 will light after entering the sequence if the Auto Mower accepts the input.

NOTE! It is important that the personal code is written down and stored in a safe place. If you should forget your personal code, contact your dealer.

Regular entry of the code

You will have to enter your personal code again from time to time. This prevents anyone from using the Auto Mower if it is stolen. When it is time to re-enter the code, the Auto Mower will indicate LED 3 solid. Note that you do not need to change your code, just enter it. The code must also be entered if the theft alarm goes off, or if the Auto Mower has been switched off.

By default, the code will have to be entered once a week, but we recommend you choose the time interval yourself, from 1 to 26 weeks, by entering:

* 6 # no. of weeks # * code #

Example: * 6 # 5 # * code # means that you must enter the code every fifth week.

Setting the sounds

The sounds the Auto Mower can make are divided into four groups:

Operating sound	The Auto Mower indicates it is mowing or charging.
Error sound	The Auto Mower indicates that something is wrong.
Start-up sound	The Auto Mower warns you that the cutting disc is about to start.
Theft alarm	Comes on if the Auto Mower is not switched off correctly.

The volumes of the operating and error sounds can be set individually between 0 and 4, where 0 = silent and 4 = loudest:

Operating sound * 2 # volume # (preset volume = 1)
Error sound * 3 # volume # (preset volume = 1)
Start-up sound * 4 # volume # (preset volume = 2)

Example: * 2 # 0 # switches off the operating sound completely.

Theft alarm

The standard setting for the theft alarm is for it to sound for 1 minute. You can choose the length of time the alarm will sound yourself, from 0 to 1000 minutes, by entering:

* 7 # no. of minutes # * code #

Example 1: * 7 # 10 # * code # sounds the theft alarm for ten minutes.

Example 2: * 7 # 0 # * code # switches the alarm off completely.

Start and stop times for mowing

IMPORTANT INFORMATION

Technically, your Auto Mower can work 24 hours a day, which it is set to do on delivery, as no times have been entered. It is not recommended to be operated this way. If the mower is set to run for too long, the grass can appear "down-trodden". In addition, component wear increases and the battery life may be shortened.

The Auto Mower has an internal clock, that can be used to decide at what time of day the Auto Mower will mow, and when it shall rest. This is done by first entering the current time, and then entering the start and stop times desired for mowing. At the set start time, the Auto Mower will begin to mow, and continue until the set stop time (charging as needed). Then the Auto Mower will begin to search for the charging station, go there, charge its battery and wait for the next scheduled start time.

Hours and minutes for the current time are set with the command:

* 50 # hhmm # Hours (hh) are set using 24 hr military time.

The mowing start and stop times are entered only as whole hours with the command:

Start time	first mowing period	* 51 # hh #
Stop time	first mowing period	* 52 # hh #
Start time	second mowing period	* 53 # hh #
Stop time	second mowing period	* 54 # hh #

Example 1: You want the Auto Mower to cut between 9:00 AM and 1:00 PM. The time is 7:45 AM when the settings are being made.

* 50 # 0745 # Note that '0745' = 7:45 AM in military time
 * 51 # 09 # Note that '09' = 9:00 AM in military time
 * 52 # 13 # Note that '13' = 1:00 PM in military time

Example 2: The Auto Mower will mow between 8:00 AM and 11:00 AM and between 6:00 PM and 11:00 PM. The clock is already set with the current time.

* 51 # 08 # Note that '08' = 8:00 AM in military time
 * 52 # 11 # Note that '11' = 11:00 AM in military time
 * 53 # 18 # Note that '18' = 6:00 PM in military time
 * 54 # 23 # Note that '23' = 11:00 PM in military time

The mower by default does not have any cutting times set, allowing it to cut 24 hours continuously. Entry of times is required.

Example: * 51 # 0 #
 * 52 # 0 #
 * 53 # 0 #
 * 54 # 0 #

The start and stop times can be zeroed by keying in * 35 #. This does not affect the setting of the clock.

The number of hours it takes to mow an area depends on many factors, such as its size, the shape of the working area and the rate of grass growth. To start off with, a suitable working time can be calculated as 1 hour per 100 m² (1000 ft²) mowing area, which for 700 m² (7000 ft²) results in 7 hours. After you have used the Auto Mower for a few weeks you will be able to judge whether the mowing time should be lengthened or shortened.

Using the Auto Mower at night will require more frequent cleaning as the grass will be damp and will then collect under the body.

Searching for a buried/hidden boundary wire

The Auto Mower has a feature that will easily find a buried/hidden boundary wire. Enter *** 5 # 1** and leave the rear cover open. Move the Auto Mower on the front wheels using the rear handle.

When the loop sensor at the front of the Auto Mower is outside the boundary wire the mower will beep, and when it is inside it is silent. When it is inside the search wire LED 3 lights up. This command only works when the charging station is connected.

If the mower does not detect any signal all four LEDs flash.

Reset the Auto Mower to normal operation by entering *** 5 # 0 #**, or by lowering the cover.

Leaving the charging station

See the chapter on "Installation" (Placing the charging station). By default the Auto Mower is set to leave the charging station at a random angle between 90° and 270°. This works well on most lawns. If you want to choose a different angle, you simply enter the angles between which you want the mower to leave the charging station, *** 65 # angle 1 #**, *** 66 # angle 2 #**.

For example: Leave between 80° and 100°: *** 65 # 80 #**, *** 66 # 100 #**.

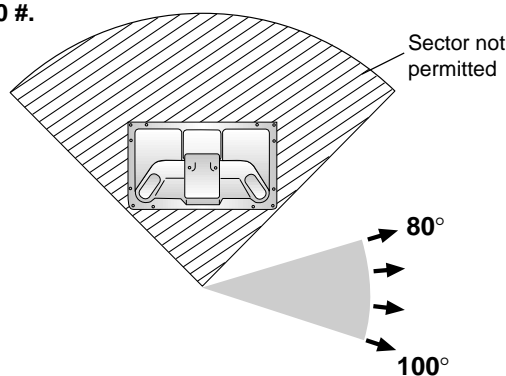

If you want it to leave alternately between two symmetrical sectors, for example 85–90° and 265°–275°, enter one range of angles, followed by *** 67 # 1 #**.

For example: 85–95° and 265°–275°: *** 65 # 85 #**, *** 66 # 95 #**, *** 67 # 1 #**.

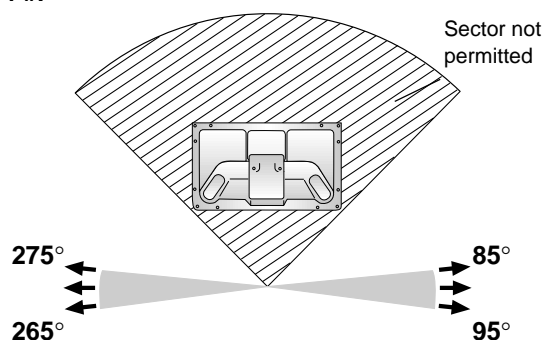

The angles at which the Auto Mower sets off can be restored to the default settings by keying in *** 36 #**.

Mowing secondary areas

To set the Auto Mower in the operating mode "mow secondary area" enter the command *** 33 #** when the mower is in the charging station. The Auto Mower will reverse out and stop immediately in front of the charging station when it is fully charged.

Now move the Auto Mower to the secondary area. When the mower is started it will run until the entire battery is discharged (this takes about 2-3 hours) and will then signal "cannot find charging station". The Auto Mower must then be returned to the charging station by hand. The operating mode "mow secondary area" is automatically cancelled.

You can also cancel the operating mode "mow secondary area" by using the command *** 34 #** before the battery is discharged. By moving the Auto Mower back to the working area where the charging station is located it will seek out the charging station itself when necessary.

USE

Sound and lamp indications

This table shows the Auto Mower's sound and lamp signal indications. When the mower cover is opened and the alarm has been switched off, the LEDs on the keypad panel will light for 12 seconds. A green LED indicates an information message and a red LED an error message. To see the latest error message again, enter * 20 #.

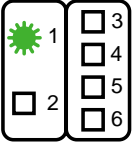
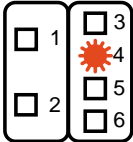
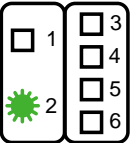
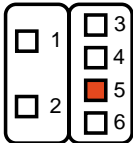
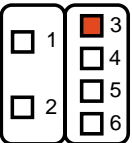
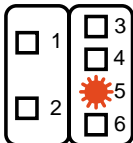
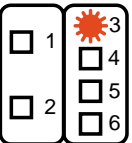
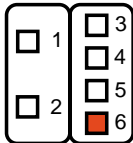
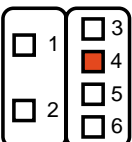
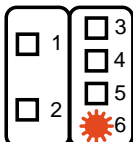
LED	Sound	Meaning	LED	Sound	Meaning
LED 1 flashes 	2 beeps every ten seconds	Charging in progress. When complete the Auto Mower will work again.	LED 4 flashes 	3 beeps per second	The Auto Mower is outside of the cutting area, or one of the wires is connected incorrectly.
LED 2 flashes 	2 beeps every ten seconds	Auto Mower has cut for the set time. It will start to mow again at the next scheduled start time.	LED 5 on 	3 beeps per second	The wheel motors are blocked or slip. Check whether anything is blocking the drive wheels.
LED 3 on 	3 beeps per second	No code or it has expired. Enter the code again.	LED 5 flashes 	3 beeps per second	The Auto Mower cannot find the charging station.
LED 3 flashes 	3 beeps per second	The Auto Mower is trapped and cannot move.	LED 6 on 	3 beeps per second	The Auto Mower cannot detect the signal from the loop wire.
LED 4 on 	3 beeps per second	The cutting disc is blocked. Switch off the switch and ensure the cutting disc can rotate freely.	LED 6 flashes 	long beep	Incorrect entry from the keypad.

The long beep after the mower cover has been lifted confirms that the cutting disc has stopped rotating.

MAINTENANCE

Replacing the blades

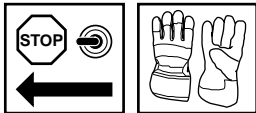

The cutting disc is bolted to the cutting motor shaft and carries three blades that are thrown outwards by centrifugal force when the disc rotates. The blades are each held in the blade disc by their own special screw.

To replace a blade:

1. Rotate the protective plate so that its holes are lined up with the screws.
2. Insert a standard or crosshead screwdriver through the hole and undo the screw.
3. Remove the blade.

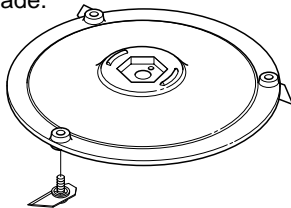

The design of the blade holders ensures that they will not come off if they hit small objects such as twigs lying on the lawn.

Check that the blades are not damaged, as this can cause vibration that may damage the Auto Mower. If one or more blades is damaged, replace all three blades at the same time, to keep the cutting disc balanced.

Battery

The service life of the battery depends on the number of hours that the Auto Mower works each day. At five hours mowing a day, the battery will normally last two to three years. The longer the daily mowing period, the shorter the battery life.

If the Auto Mower has been able to find the charging station without difficulty for quite a long time, but then suddenly stops and signals "Cannot find charging station" (3 beeps per second, LED 5 flashing), this may be a sign that the battery needs replacing. Contact your local dealer to check the condition of the battery.

Winter storage

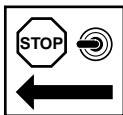

- During the winter the Auto Mower should be stored in a dry place, preferably in the Husqvarna storage case. The original packaging or storing on all four wheels with the power switch set to "STOP" may be used.
- The battery does not require any maintenance over winter.
- The charging station should be covered during the winter to protect it from moisture, a tarpaulin or plastic bag are suitable. If the docking unit is taken indoors for the winter the lower section must also be taken in. The transformer should then be disconnected from the receptacle and the six wires disconnected from the lower section. The wire ends should then be protected from moisture by inserting them in the Husqvarna waterproof connector. If this is not done, the cables will become oxidized. An oxidized conductor will not give satisfactory electrical connection.

Cleaning

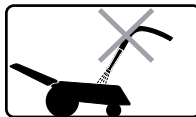

NOTE!

Never use a high pressure washer, or even running water, to clean the Auto Mower, as water can get into the electronics and destroy sensitive components.

Body, outside

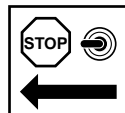

Use a sponge or soft cloth and water to clean the mower body. If it is very dirty, a soap solution or mild washing liquid may be used.

NOTE!

Never use solvents such as acetone, petroleum based or similar chemicals to clean the mower body.

Underbody and cutting disc

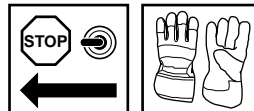

Inspect the cutting disc and blades once a week. Check that the cutting disc can rotate freely and easily. Also check that the protective plate can rotate freely and easily relative to the cutting disc.

Use a brush to remove any clumps of grass or foreign objects and clean the blades if necessary.

Charging pins and contact plates

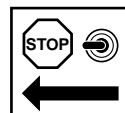

If the Auto Mower's charging pins have black marks this is a sign of poor electrical contact with the contact plates of the charging station. Fill in any holes under the rear wheels of the mower and bend down the contact plates so that they make good contact with the pins.

Remove corrosion from the Auto Mower charging pins and charging station contact plates if necessary, e.g. after winter storage or if there is a problem with charging. Use a fine abrasive cloth to clean the charging pins and contact plates.

NOTE!

The transformer power cable must not be inserted in the receptacle when the charging station contact plates are being cleaned. If the transformer is connected and a metal object touches the contact plates they can short-circuit and blow the transformer fuse. There is no risk of harmful electric shock from the 15 V low-voltage supply.

TROUBLE SHOOTING

Trouble shooting chart

Refer to “Sound and lamp indications” for explanations of the Auto Mower indications. Before trouble shooting, first charge the Auto Mower battery in the charging station to eliminate faults due to low battery charge. Read through the entire Operator’s Manual to make sure that the fault cannot be easily solved by using the keypad commands or the power switch.

Fault indication	Possible cause	Action
<p>The Auto Mower cannot detect the signal from the boundary wire.</p> <p>3 beeps/second LED 6 is on</p>	The transformer is not connected to the receptacle or the fuse has blown.	<p>Use the test switch on the charging station to check loop wires and power supply.</p> <ul style="list-style-type: none"> • A continuous beep means that the search and boundary wires are not broken. • An series of beeps means incorrect installation or a break in the search or boundary wire. Ensure that the search and boundary wires have been installed in accordance with the installation instructions, or repair the break in the wire.
	Break in the boundary wire.	Check the wire by using the test switch as described above.
	If this only happens at certain places on the lawn it may be caused by metal objects (fencing, iron strengthening bars etc.) or cables buried nearby.	Check by moving the position of the boundary wire.
	If this happens near to an “island”, it may be because the boundary wire has been laid in the wrong direction around the “island” and is cancelling out its own signal.	Ensure that the boundary wire has been installed in accordance with the installation instructions.
<p>The Auto Mower cannot find the charging station.</p> <p>3 beeps/second LED 5 flashes</p>	Incorrectly adjusted docking unit. The Mower charging pins do not make good connection with the charging station contact plates.	<ul style="list-style-type: none"> • Use a fine abrasive cloth to clean the surfaces of the charging pins and contact plates. • Make sure that the mower is standing on flat ground and that neither of the rear wheels is in a dip. • Adjust the docking unit horizontally and vertically. • If necessary bend the contact plates down slightly.
	Auto Mower cannot find the search wire.	Change the route of the search wire so that it better covers the working area.
	Break in the search wire.	Check the wire by using the test switch as described above.
	Battery requires reconditioning.	The battery requires reconditioning. Place the Auto Mower in the charging station and enter * 71 #. The battery will be reconditioned automatically, which will take 6–10 hours. The mower will give its usual charging signals during this time. When reconditioning is complete the mower will return automatically to normal operation. It is an advantage if the battery is reconditioned at night when it is cooler. If the problem persists, contact your dealer for assistance.
	Battery is past usable life.	Contact your dealer to get a replacement battery.

TROUBLE SHOOTING

Observation	Possible cause	Action
The Auto Mower goes outside the cutting area	If this only happens at certain places on the lawn it may be caused by metal objects (fencing, iron strengthening bars etc.) or cables buried nearby.	Check by moving the position of the boundary wire.
	The cutting area is sloping too steeply.	Ensure that the boundary wire has been installed in accordance with the installation instructions.
	The boundary wire has been installed incorrectly around an "island".	Ensure that the boundary wire has been installed in accordance with the installation instructions.
	The boundary wire has been installed too close to the edge of the area that you want to use as the working area.	Ensure that the boundary wire has been installed in accordance with the installation instructions.
Uneven mowing result	The Auto Mower is cutting too few hours each day.	Lengthen the working time, see "Settings".
	The working area is too large.	Try reducing the size of the working area or lengthening the working time, see "Settings".
	The blades are dull.	Change all three blades, to keep the cutting disc balanced.
	Grass is too long in relation to the set cutting height.	Raise the mowing height. Gradually lower the cutting height until the desired height has been achieved.
	Clumps of grass clippings on the cutting disc or around the motor shaft.	Use a small brush or wood dowel to clean off the grass clippings. Check that the cutting disc rotates freely.
The Auto Mower cuts at the wrong time	The Auto Mower clock requires setting.	Set the clock, see "Settings".
	The cutting start and stop times are incorrectly set.	Set the mowing start and stop times again, see "Settings".
The Auto Mower vibrates	Unbalanced cutting disc or damaged blades.	Clean the cutting disc and/or change all three blades. If cleaning is necessary between the riveted discs, remove the blades and clean using steel wire. Replace the blades.
Auto Mower runs around but the cutting disc does not rotate.	Auto Mower is searching for the charging station.	No action. The cutting disc does not rotate when the mower is searching for the charging station.
The mower runs for shorter periods than usual between recharging.	Grass or a foreign object is slowing down the cutting disc or protective plate.	Clean the cutting disc and protective plate.
Mowing and charging times are both shorter than usual.	This is normal behaviour when the temperature is high (gradually increasing above 25°C/80°F).	

OWNER INFORMATION

Serial number: _____

Personal code: _____

Date of Purchase: _____

Dealer Name: _____

Dealer Phone Number: _____

EU declaration of conformity (Only applies to Europe)

(Directive 89/392/EEC, Annex II, A)

We, **Husqvarna AB**, S-561 82 Huskvarna, Sweden, tel +46 36-146500, declare under sole responsibility that the automatic lawn mower Husqvarna **Auto Mower** from 1998's serial numbers and onwards (the year is clearly stated in plain text on the type plate with subsequent serial number), is in conformity with the following standards or other normative documents following the provisions in the COUNCIL'S DIRECTIVES:

- of June 14 1989 "relating to machinery" **89/392/EEC** and applicable supplements.
- of May 3 1989 "relating to electromagnetic compatibility" **89/336/EEC** and applicable supplements.

The following standards have been applied: **EN292-2**.

Huskvarna 20 December, 1999



Bo Andréasson, Development manager





2000W49