

**Operator's manual (EPA)**  
**323P4 325P5 X-series**

Please read the operator's manual carefully and make sure you understand the instructions before using the machine.

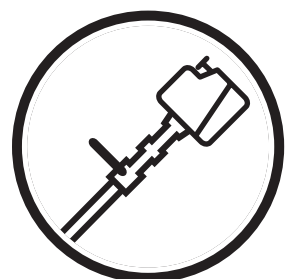

**English**

# KEY TO SYMBOLS

## Symbols

**WARNING!** The machine can be a dangerous tool if used incorrectly or carelessly, which can cause serious or fatal injury to the operator or others.



Please read the operator's manual carefully and make sure you understand the instructions before using the machine.



Always wear:

- A protective helmet where there is a risk of falling objects
- Approved hearing protection
- Protective goggles or a visor



This machine is not electrically insulated. If the machine touches or comes close to high-voltage power lines it could lead to death or serious bodily injury. Electricity can jump from one point to another by arcing. The higher the voltage, the greater the distance electricity can jump. Electricity can also travel through branches and other objects, especially if they are wet. Always keep a distance of at least 10 m between the machine and high-voltage power lines and/or any objects that are touching them. If have to work within this safe distance you should always contact the relevant power company to make sure the power is switched off before you start work.

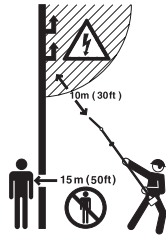

This machine has a long reach. Make sure that no people or animals come closer than 15 m when the machine is running.

Always wear approved protective gloves.



Wear sturdy, non-slip boots.



Other symbols/decals on the machine refer to special certification requirements for certain markets.

Switch off the engine by moving the stop switch to the STOP position before carrying out any checks or maintenance.

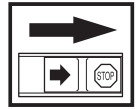

Always wear approved protective gloves.



Regular cleaning is required.

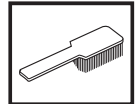

Visual check.



Protective goggles or a visor must be worn.



Filling with chain oil and adjusting oil flow



# CONTENTS

## Contents

### KEY TO SYMBOLS

Symbols ..... 2

### CONTENTS

Contents ..... 3

Note the following before starting: ..... 3

### SAFETY INSTRUCTIONS

Personal protective equipment ..... 4

Machine's safety equipment ..... 4

Checking, maintaining and servicing the machine's safety equipment ..... 5

General safety precautions ..... 11

Safety instructions for using a pruning saw ..... 12

### WHAT IS WHAT?

What is what? ..... 15

### ASSEMBLY

Fitting the cutting head ..... 16

Fitting the bar and chain ..... 16

Adjusting the harness ..... 16

Filling with oil ..... 16

Assembling and dismantling the two-piece shaft (325P5) ..... 17

### FUEL HANDLING

Fuel ..... 18

Fuelling ..... 18

### STARTING AND STOPPING

Check before starting ..... 19

Starting and stopping ..... 19

### MAINTENANCE

Carburettor ..... 20

Muffler ..... 21

Cooling system ..... 22

Spark plug ..... 22

Air filter ..... 22

Bevel gear ..... 23

Maintenance schedule ..... 23

### TECHNICAL DATA

Technical data ..... 24

### FEDERAL EMISSION CONTROL WARRANTY STATEMENT

YOUR WARRANTY RIGHTS AND OBLIGATIONS ..... 26

## Note the following before starting:



**WARNING!** Under no circumstances may the design of the machine be modified without the permission of the manufacturer. Always use genuine accessories. Non-authorized modifications and/or accessories can result in serious personal injury or the death of the operator or others.

**Your warranty does not cover damage or liability caused by the use of non-authorized accessories or replacement parts.**

The machine is only designed for cutting branches and twigs.

Maintenance, replacement, or repair of the emission control devices and system may be performed by any nonroad engine repair establishment or individual.

Husqvarna AB has a policy of continuous product development and therefore reserves the right to modify the design and appearance of products without prior notice.

This decal certifies that the product has been approved in accordance with American exhaust emissions requirements EPA Ph II and CARB Tier II. The Emissions Compliance Period referred to on the Emissions Compliance label indicates the numbers of operating hours for which the engine has been shown to meet Federal and California emission requirements.

 **Husqvarna**

HUSQVARNA AB HUSKVARNA SWEDEN  
IMPORTANT ENGINE INFORMATION TWC  
THIS ENGINE CONFORMS TO U.S. EPA PH1  
FOR SMALL NON - ROAD ENGINES.  
REFER TO OPERATOR'S MANUAL FOR  
MAINTENANCE SPECIFICATIONS AND ADJUSTMENTS.



## WARNING

The engine exhaust from this product contains chemicals known to the State of California to cause cancer, birth defects or other reproductive harm.

# SAFETY INSTRUCTIONS

## Personal protective equipment

**IMPORTANT INFORMATION** The machine can be a dangerous tool if used incorrectly or carelessly, which can cause serious or fatal injury to the operator or others. Please read the operator's manual carefully and make sure you understand the instructions before using the machine. You must wear approved protective equipment whenever you use the machine. Personal protective equipment cannot eliminate the risk of injury but it will reduce the degree of injury if an accident does happen. Ask your dealer for help in choosing the right equipment.



**WARNING! Remove your hearing protection as soon as you stop the engine, so that you can hear any noises or warning signals.**

### GLOVES

Gloves must be worn when required, for example when fitting, inspecting or cleaning cutting attachments.



### PROTECTIVE HELMET AND VISOR



**HEARING PROTECTION** Wear hearing protection that provides adequate noise reduction.

**EYE PROTECTION** Blows from branches or objects that are thrown out by a cutting attachment can damage the eyes.

### BOOTS

Wear sturdy, non-slip boots.



**CLOTHING** Wear clothes made of a strong fabric and avoid loose clothing that can catch on twigs and branches. Always wear heavy, long pants. Do not wear jewellery, shorts sandals or go barefoot. Secure hair so it is above shoulder level.

### FIRST AID KIT

Always have a first aid kit nearby.



## Machine's safety equipment

This section describes the machine's safety equipment, its purpose, and how checks and maintenance should be carried out to ensure that it operates correctly. See the "What is what?" section to locate where this equipment is positioned on your machine.



**WARNING! Never use a machine that has faulty safety equipment! Carry out the inspection, maintenance and service routines listed in this section.**

### Throttle lock

The throttle lock is designed to prevent accidental operation of the throttle control. When you press the lock (A) (i.e. when you grasp the handle) it releases the throttle control (B). When you release the handle the throttle control and the throttle lock both move back to their original positions. This movement is controlled by two independent return springs. This arrangement means that the throttle control is automatically locked at the idle setting.

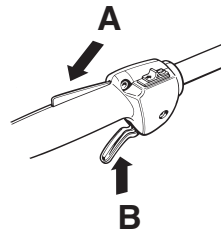

### Stop switch

Use the stop switch to switch off the engine.

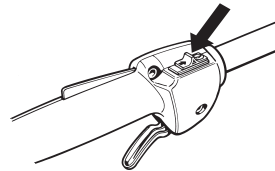

### Vibration damping system

Your machine is equipped with a vibration damping system that is designed to minimise vibration and make operation easier.

# SAFETY INSTRUCTIONS

The machine's vibration damping system reduces the transfer of vibration between the engine unit/cutting equipment and the machine's handle unit.

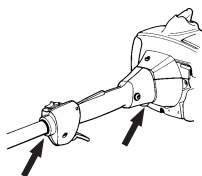

**WARNING!** Overexposure to vibration can lead to circulatory damage or nerve damage in people who have impaired circulation. Contact your doctor if you experience symptoms of overexposure to vibration. Such symptoms include numbness, loss of feeling, tingling, pricking, pain, loss of strength, changes in skin colour or condition. These symptoms normally appear in the fingers, hands or wrists. The risk increases at low temperatures.

## Muffler

The muffler is designed to keep noise levels to a minimum and to direct exhaust fumes away from the user.



A muffler fitted with a catalytic converter is also designed to reduce harmful exhaust gases.

In countries that have a warm and dry climate there is a significant risk of fire. We therefore fit certain mufflers with a spark arrestor mesh. Check whether the muffler on your machine is fitted with this kind of mesh.

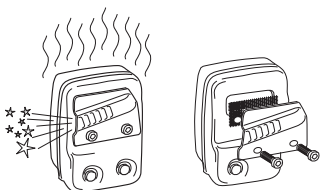

For mufflers it is very important that you follow the instructions on checking, maintaining and servicing your machine. See instructions under the heading Checking, maintaining and servicing the machine's safety equipment.



**WARNING!** Mufflers fitted with catalytic converters get very hot during use and remain so for some time after stopping. This also applies at idle speed. Contact can result in burns to the skin. Remember the risk of fire!



**WARNING!** The inside of muffler contain chemicals that may be carcinogenic. Avoid contact with these elements in the event of a damaged muffler.



**WARNING!** Engine exhaust fumes contain carbon monoxide, which can cause carbon monoxide poisoning. For this reason you should not start or run the machine indoors, or anywhere that is poorly ventilated.

The exhaust fumes from the engine are hot and may contain sparks which can start a fire. Never start the machine indoors or near combustible material!

## Checking, maintaining and servicing the machine's safety equipment

### IMPORTANT!

All servicing and repair work on the machine requires special training. This is especially true of the machine's safety equipment. If your machine fails any of the checks described below you must contact your service agent. When you buy any of our products we guarantee the availability of professional repairs and service. If the retailer who sells your machine is not a servicing dealer, ask him for the address of your nearest service agent.

### Throttle lock

- Make sure the throttle control is locked at the idle setting when the throttle lock is released.

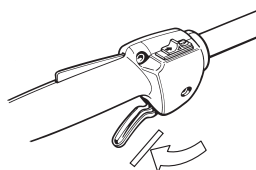

- Press the throttle lock and make sure it returns to its original position when you release it.

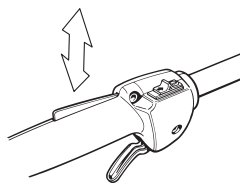

- Check that the throttle control and throttle lock move freely and that the return springs work properly.

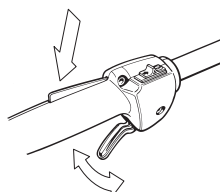

# SAFETY INSTRUCTIONS

- See instructions under the heading Start. Start the machine and apply full throttle. Release the throttle and check that the cutting attachment stops and remains at a standstill. If the cutting attachment rotates with the throttle in the idle position then the carburettor idle setting must be checked. See instructions under the heading Maintenance.

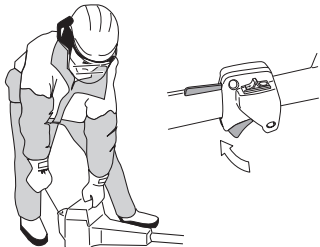

## Stop switch

- Start the engine and make sure the engine stops when you move the stop switch to the stop setting.

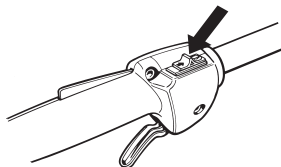

## Vibration damping system



- Regularly check the vibration damping units for cracks or deformation.
- Check that the vibration damping element is undamaged and securely attached.

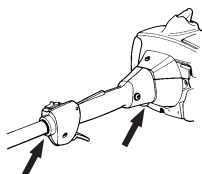

## Muffler



- Never use a machine that has a faulty muffler.



- Regularly check that the muffler is securely attached to the machine.

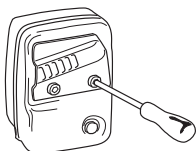

- If the muffler on your machine is fitted with a spark arrestor mesh this must be cleaned regularly. A blocked mesh will cause the engine to overheat and may lead to serious damage.

Never use a muffler with a defective spark arrestor mesh.

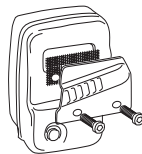

## Cutting equipment



This section describes how you can achieve maximum clearing capacity and extend the life of the cutting attachment through correct maintenance and using the right type of cutting attachment.

Check the cutting equipment with regard to damage and crack formation. Damaged cutting equipment should always be replaced.

- **Only use cutting equipment recommended by us!**

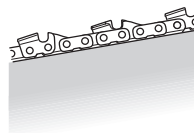

- **Keep the chain's cutting teeth properly sharpened! Follow our instructions and use the recommended file gauge.** A damaged or badly sharpened chain increases the risk of accidents.



- **Maintain the correct raker clearance! Follow our instructions and use the recommended raker gauge.** Too large a clearance increases the risk of kickback.



- **Keep the chain properly tensioned!** If the chain is slack it is more likely to jump off and lead to increased wear on the bar, chain and drive sprocket.



# SAFETY INSTRUCTIONS

- **Keep cutting equipment well lubricated and properly maintained!** A poorly lubricated chain is more likely to break and lead to increased wear on the bar, chain and drive sprocket.

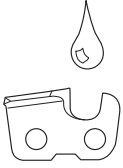

**WARNING!** Never use a machine with faulty safety equipment. The machine's safety equipment must be checked and maintained as described in this section. If your machine fails any of these checks contact your service agent to get it repaired.



**WARNING!** Always stop the engine before doing any work on the cutting attachment. This continues to rotate even after the throttle has been released. Ensure that the cutting attachment has stopped completely and disconnect the HT lead from the spark plug before you start to work on it.

## Specification of bar and saw chain

When the cutting attachment supplied with your machine has to be replaced, because it is worn out or damaged, you must only fit the types of bar and saw chain recommended by us.

### Bar

- Length (inches/cm)

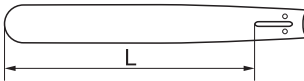

- Number of teeth on bar tip sprocket (T). Small number = small tip radius = low risk of kickback.

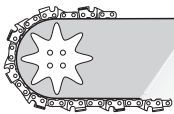

- Chain pitch (inches). The spacing between the drive links of the chain must match the spacing of the teeth on the bar tip sprocket and drive sprocket.

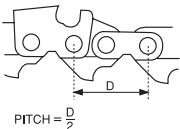

- Number of drive links. The number of drive links is determined by the length of the bar, the chain pitch and the number of teeth on the bar tip sprocket.



- Bar groove width (inches/mm). The groove in the bar must match the width of the chain drive links.



- Saw chain oil hole and hole for chain tensioner pin.

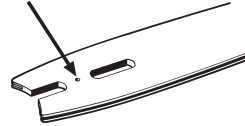

## Chain

- Saw chain pitch (inches). (The distance between three drive links, divided by two.)

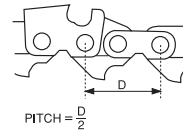

- Drive link width (mm/inches)

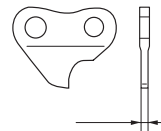

- Number of drive links.

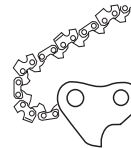

Level of kickback reduction. The only thing that describes the level of kickback reduction offered by a saw chain is its model number.

## Sharpening your chain and adjusting raker clearance



**WARNING!** The risk of kickback is increased with a badly sharpened chain!

### General information on sharpening cutting teeth

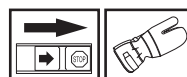

- Never use a blunt chain. When the chain is blunt you have to exert more pressure to force the bar through the wood and the cuttings will be very small. If the chain is very blunt it will not produce any cuttings at all. Wood powder would be the only result.
- A sharp chain eats its way through the wood and produces long, thick cuttings.

# SAFETY INSTRUCTIONS

- The cutting part of the chain is called the cutting link and this consists of a cutting tooth (A) and the raker lip (B). The cutting depth is determined by the difference in height between the two.

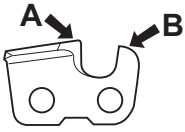

- When you sharpen a cutting tooth there are five important factors to remember.

- Filing angle

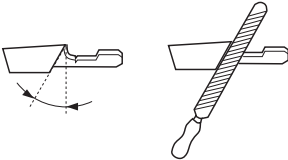

- Cutting angle

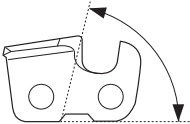

- File position

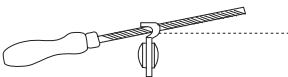

- Round file diameter

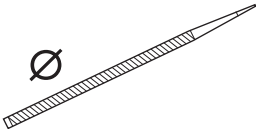

- File depth

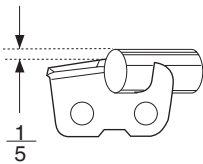

It is very difficult to sharpen a chain correctly without the right equipment. We recommend that you use our file gauge. This will help you obtain the maximum kickback reduction and cutting performance from your chain.

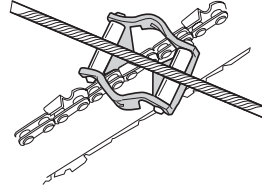

**WARNING!** The following faults will increase the risk of kickback considerably:

**File angle too large**

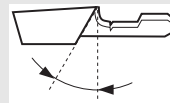

**Cutting angle too small**

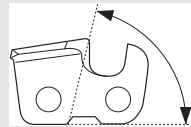

**File diameter too small**

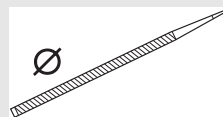

## Sharpening cutting teeth



To sharpen cutting teeth you will need a round file and a file gauge.

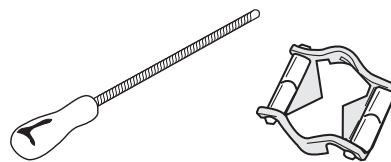

- Check that the chain is correctly tensioned. A slack chain will move sideways, making it more difficult to sharpen correctly.
- Always file cutting teeth from the inside face outwards. Reduce the pressure on the return stroke. File all the teeth on one side of the bar first. Then turn the saw over and file the remaining teeth from the other side.

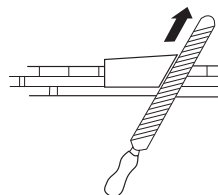



# SAFETY INSTRUCTIONS

- File all the teeth to the same length. When the length of the cutting teeth is reduced to 4 mm (0.16") the chain is worn out and should be replaced.

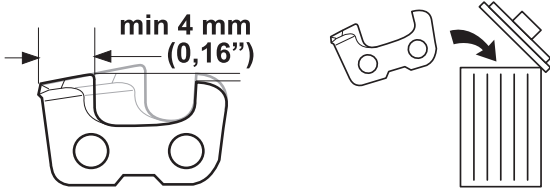

## General advice on setting raker clearance

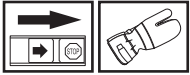

- When you sharpen the cutting teeth you reduce the raker clearance (=cutting depth). To maintain optimal cutting performance you must file back the raker lip to the recommended height.

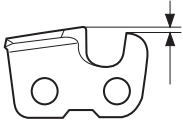

- On a low-kickback cutting link the front edge of the raker lip is rounded. It is very important that you maintain this radius or bevel when you adjust the raker clearance.



- We recommend that you use our raker gauge to achieve the correct clearance and bevel on the raker lip.

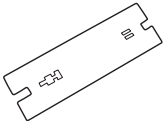

**WARNING! The risk of kickback is increased if the raker clearance is too large!**

## Setting the raker clearance



- Before setting the raker clearance the cutting teeth should be newly sharpened.

We recommend that you adjust the raker clearance every third time you sharpen the chain. NOTE! This recommendation assumes that the length of the cutting teeth is not reduced excessively.

- To adjust the raker clearance you will need a flat file and a raker gauge.

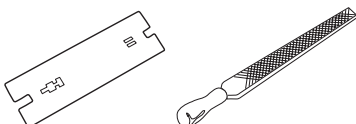

- Place the gauge over the raker lip.

- Place the file over the part of the lip that protrudes through the gauge and file off the excess. The clearance is correct when you no longer feel any resistance as you draw the file over the gauge.

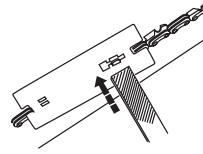

## Tensioning the chain

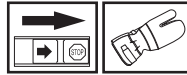

**WARNING! A slack chain may jump off and cause serious or even fatal injury.**

- The more you use a chain the longer it becomes. It is therefore important to adjust the chain regularly to take up the slack.
- Check the chain tension every time you refuel. NOTE! A new chain has a running-in period during which you should check the tension more frequently.
- Tension the chain as tightly as possible, but not so tight that you cannot pull it round freely by hand.

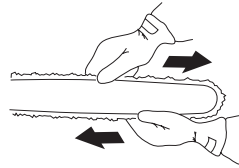

- Undo the bar nut.

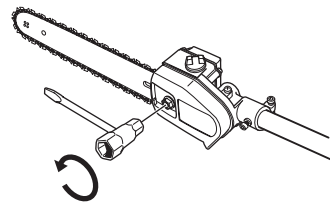

- Tension the chain by turning the chain tensioning screw clockwise using the combination spanner. The chain should be tensioned until it does not sag from the underside of the bar.

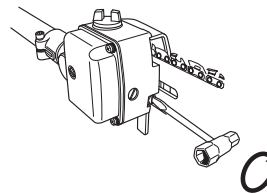

# SAFETY INSTRUCTIONS

- Use the combination spanner to tighten the blade nut while holding up the tip of the bar. Check that you can pull the saw chain round freely by hand.

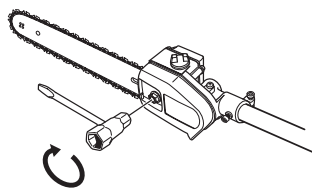

## Lubricating cutting equipment



**WARNING! Poor lubrication of cutting equipment may cause the chain to snap, which could lead to serious, even fatal injuries.**

### Chain oil

- Chain oil must demonstrate good adhesion to the chain and also maintain its flow characteristics regardless of whether it is warm summer or cold winter weather.
- As a chain saw manufacturer we have developed an optimal chain oil which, with its vegetable oil base, is also biodegradable. We recommend the use of our own oil for both maximum chain life and to minimise environmental damage.
- If our own chain oil is not available, standard chain oil is recommended.
- In areas where oil specifically for lubrication of saw chains is unavailable, ordinary EP 90 transmission oil may be used.
- **Never use waste oil!** This is dangerous for yourself, the machine and the environment.

### Filling with chain oil



The oil pump is preset at the factory to meet most lubrication requirements. A full oil tank will last about half as long as a full tank of fuel. You should therefore check the level of oil in the oil tank regularly to avoid damage to the saw chain and bar that could occur due to lack of lubrication.

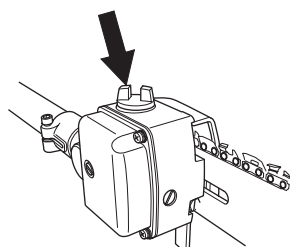

### Checking chain lubrication

- Check the chain lubrication each time you refuel.

Aim the tip of the bar at a light coloured surface about 20 cm (8 inches) away. After 1 minute running at 3/4 throttle you should see a distinct line of oil on the light surface.

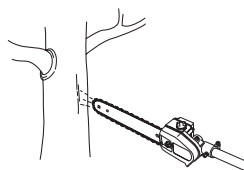

### Adjusting chain lubrication

When cutting dry or hard species of wood it may be necessary to increase lubrication. To adjust the oil flow, first undo screw (A) then turn the adjuster screw (B) anticlockwise. Re-tighten screw (A). Remember that this will increase the oil consumption and you should therefore check the level in the oil tank more frequently.

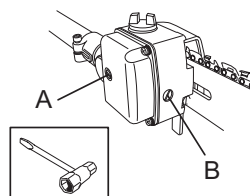

### What to do if lubrication does not work:

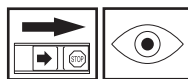

- Check that the oil channel in the bar is not obstructed. Clean if necessary.

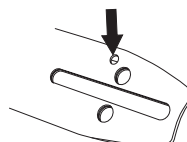

- Check that the oil channel in the gear housing is clean. Clean if necessary.
- Check that the bar tip sprocket turns freely. If the chain lubrication system is still not working after carrying out the above checks you should contact your service workshop.

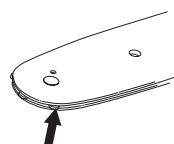

### Checking wear on cutting equipment

#### Chain

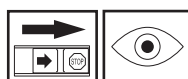

Check the chain daily for:

- Visible cracks in rivets and links.
- Whether the chain is stiff.

# SAFETY INSTRUCTIONS

- Whether rivets and links are badly worn.

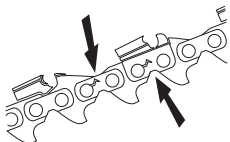

We recommend you compare the existing chain with a new chain to decide how badly the existing chain is worn.

When the length of the cutting teeth has worn down to only 4 mm the chain must be replaced.

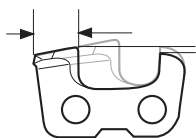

## Chain drive sprocket



Regularly check the degree of wear on the drive sprocket. Replace if wear is excessive.

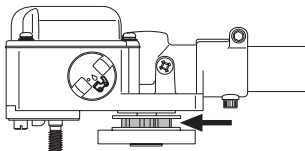

## Vibration damping system



Check regularly that the vibration damping element is free from cracks. Check regularly the degree of wear to the rubber dampers. Replace them if worn.

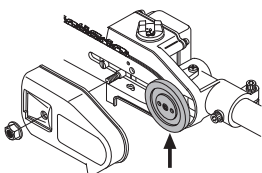

## Bar



Check regularly:

- Whether there are burrs on the edges of the bar. Remove these with a file if necessary.

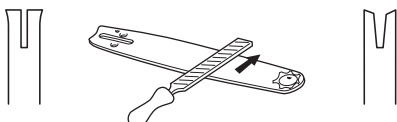

- Whether the groove in the bar has become badly worn. Replace the bar if necessary.
- Whether the tip of the bar is uneven or badly worn. If a hollow forms on the underside of the bar tip this is due to running with a slack chain.

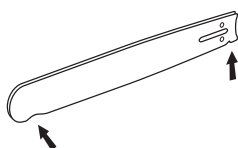

- To prolong the life of the bar you should turn it over daily.

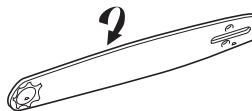

**WARNING! A faulty cutting attachment may increase the risk of accidents.**

## General safety precautions

### Important

The machine is only designed for cutting branches and twigs.

The only accessories to be used with the engine unit as a drive source are the cutting units we recommend in the chapter "Technical data".

Never use the machine if you are tired, if you have drunk alcohol, or if you are taking medication that could affect your vision, your judgement or your co-ordination.

Wear personal protective equipment. See instructions under the heading Personal protective equipment.

Never use a machine that has been modified in any way from its original specification.

Never use a machine that is faulty. Carry out the checks, maintenance and service instructions described in this manual. Some maintenance and service measures must be carried out by trained and qualified specialists. See instructions under the heading Maintenance.

All covers and guards must be fitted before starting. Make sure the spark plug cap and HT lead are not damaged. Otherwise you could get an electric shock.

The machine operator shall ensure, while working, that no persons or animals come closer than 15 metres (50 feet). When several operators are working in the same area the safety distance should be at least double tree length, however, at least 15 metres (50 feet).



**WARNING! Faulty cutting equipment increases the risk of accidents.**

## Starting



**WARNING! When the engine is started with the choke in either the choke or start throttle positions, the cutting equipment starts to move immediately.**

- The complete clutch cover and shaft must be fitted before the machine is started, otherwise the clutch can come loose and cause personal injury.
- Never start the machine indoors. Exhaust fumes can be dangerous if inhaled.
- Observe your surroundings and make sure that there is no risk of people or animals coming into contact with the cutting equipment.

# SAFETY INSTRUCTIONS

- Place the machine on the ground, ensure the cutting attachment is clear of twigs and stones. Hold the body of the machine on the ground using your left hand (CAUTION! Not with your foot). Then grip the starter handle with your right hand and pull the starter cord.



## Fuel safety



- Always use a fuel container with an anti-spill valve.
- Never refuel the machine while the engine is running. Always stop the engine and let it cool for a few minutes before refuelling.
- Make sure there is plenty of ventilation when refuelling or mixing fuel (gasoline and 2-stroke oil).
- Move the machine at least 3 m from the refuelling point before starting it.

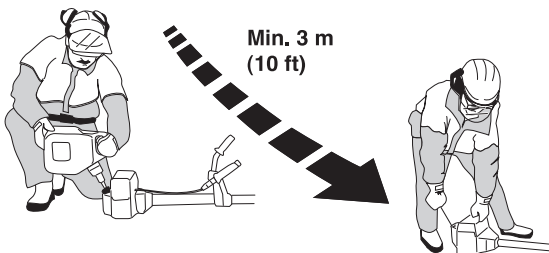

- Never start the machine:
- If you have spilt fuel on it. Wipe off the spillage and allow remaining fuel to evaporate.
  - If you spill fuel or chain oil on yourself or your clothes. Change your clothes.
  - If the machine is leaking fuel. Check regularly for leaks from the fuel cap and fuel lines.

## Transport and storage

- Store and transport the machine and fuel so that there is no risk of any leakage or fumes coming into contact with sparks or naked flames, for example, from electrical machinery, electric motors, electrical relays/switches or boilers.
- When storing and transporting fuel always use approved containers intended for this purpose.
- When storing the machine for long periods the fuel tank must be emptied. Contact your local gas station to find out where to dispose of excess fuel.
- Ensure the machine is cleaned and that a complete service is carried out before long-term storage.
- If the machine is to be transported on a vehicle, it must be secured to avoid damage or fuel leakage. You should also make sure that the machine cannot injure any person or animal during transport. Observe relevant traffic regulations.

- The transport guard must always be fitted to the cutting attachment when the machine is being transported or in storage.



**WARNING! Take care when handling fuel. Bear in mind the risk of fire, explosion and inhaling fumes.**

## Safety instructions for using a pruning saw



**WARNING! The machine can cause serious personal injury. Read the safety instructions carefully. Learn how to use the machine.**



**WARNING! Cutting tool. Do not touch the tool without first switching off the engine.**

CAUTION! Please read the operator's manual carefully and make sure you understand the instructions before using the machine.

## Personal protection



- Always wear boots and other equipment described under the heading Personal protective equipment.
- Always wear working clothes and heavy-duty long trousers.
- Never wear loose clothing or jewellery.
- Make sure your hair does not hang below shoulder level.

## Safety instructions regarding the surroundings

- Never allow children to use the machine.
- Ensure that no-one comes closer than 15 m while you are working.
- Never allow anyone else to use the machine without first ensuring that they have understood the contents of the operator's manual.
- Never work from a ladder, stool or any other raised position that is not fully secured.



# SAFETY INSTRUCTIONS

## Safety instructions while working



- Always ensure you have a safe and stable working position
- Always use both hands to hold the machine. Hold the machine at the side of your body.



- Use your right hand to control the throttle setting.
- Make sure that your hands and feet do not come near the cutting attachment when the engine is running.
- When the engine is switched off, keep your hands and feet away from the cutting attachment until it has stopped completely.
- Watch out for stumps of branches that can be thrown out during cutting.
- Always lay the machine on the ground when you are not using it.
- Check the working area for foreign objects such as electricity cables, insects and animals, etc, or other objects that could damage the cutting attachment, such as metal items.
- If any foreign object is hit or if vibrations occur stop the machine immediately. Disconnect the HT lead from the spark plug. Check that the machine is not damaged. Repair any damage.
- If anything gets caught up in the cutting equipment while you are working, switch off the engine and let it stop completely and remove the ignition lead before cleaning the cutting equipment.
- This machine is not electrically insulated. If the machine touches or comes close to high-voltage power lines it could lead to death or serious bodily injury.

## Safety instructions after completing work



- The transport guard should always be fitted to the cutting attachment when the machine is not in use.
- Make sure the cutting attachment has stopped before cleaning, carrying out repairs or an inspection. Disconnect the HT lead from the spark plug.

- Always wear heavy-duty gloves when repairing the cutting attachment. This is extremely sharp and can easily cause cuts.

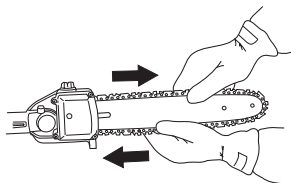

- Store the machine out of reach of children.
- Use only original spare parts for repairs.

## Basic working techniques

- Hold the machine as close to your body as possible to get the best balance.



- Make sure that the tip does not touch the ground.
- Do not rush the work, but work steadily until all the branches have been cut back cleanly.
- Always slow the engine to idle speed after each working operation. Long periods at full throttle without any load on the engine can lead to serious engine damage.
- Always work at full throttle.
- Let the engine drop back to idle speed between each cut. Long periods at full throttle can cause serious damage to the centrifugal clutch.



**WARNING! Never stand directly underneath a branch that is being cut. This could lead to serious or even fatal personal injury.**

Observe great care when working close to overhead power lines. Falling branches can result in short-circuiting.



**WARNING! Observe the applicable safety regulations for work in the vicinity of overhead power lines.**

# SAFETY INSTRUCTIONS



**WARNING!** This machine is not electrically insulated. If the machine touches or comes close to high-voltage power lines it could lead to death or serious bodily injury. Electricity can jump from one point to another by arcing. The higher the voltage, the greater the distance electricity can jump. Electricity can also travel through branches and other objects, especially if they are wet. Always keep a distance of at least 10 m between the machine and high-voltage power lines and/or any objects that are touching them. If have to work within this safe distance you should always contact the relevant power company to make sure the power is switched off before you start work.



**WARNING!** This machine has a long reach. Make sure that no people or animals come closer than 15 m when the machine is running.

- Whenever possible position yourself so that you can make the cut at right angles to the branch.

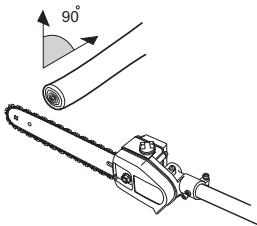

- Do not work with the shaft held straight out in front of you (like a fishing rod) as this increases the apparent weight of the cutting attachment.

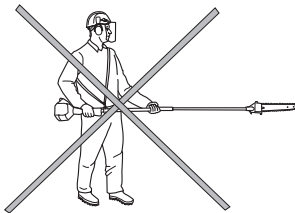

- Cut large branches in sections so that you have better control over where they fall.

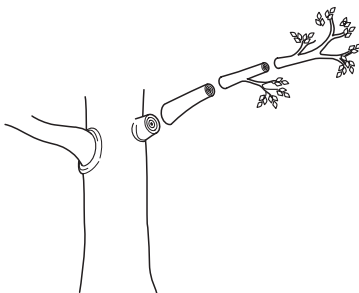

- Never cut through the swelling at the root of the branch as this will slow down healing and increase the risk of fungal attack!

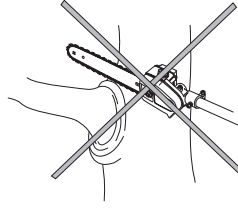

- Use the stop at the base of the cutting head to provide support during cutting. This will help prevent the cutting attachment from "jumping" on the branch.

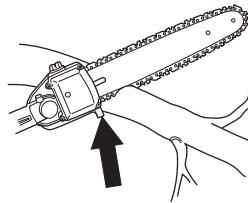

- Make an initial cut on the underside of the branch before cutting through the branch. This will prevent tearing of the bark, which could lead to slow healing and cause permanent damage to the tree. The cut should not be deeper than 1/3 of the branch thickness to prevent jamming. Keep the chain running while you withdraw the cutting attachment from the branch to prevent it jamming.

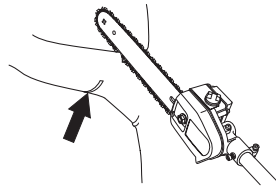

- Use the harness to support the weight of the machine and make it easier to handle.



- Make sure you have a firm footing and that you can work without being hampered by branches, stones and trees.



**WARNING!** Never activate the throttle without having the cutting attachment in full view.

# WHAT IS WHAT?

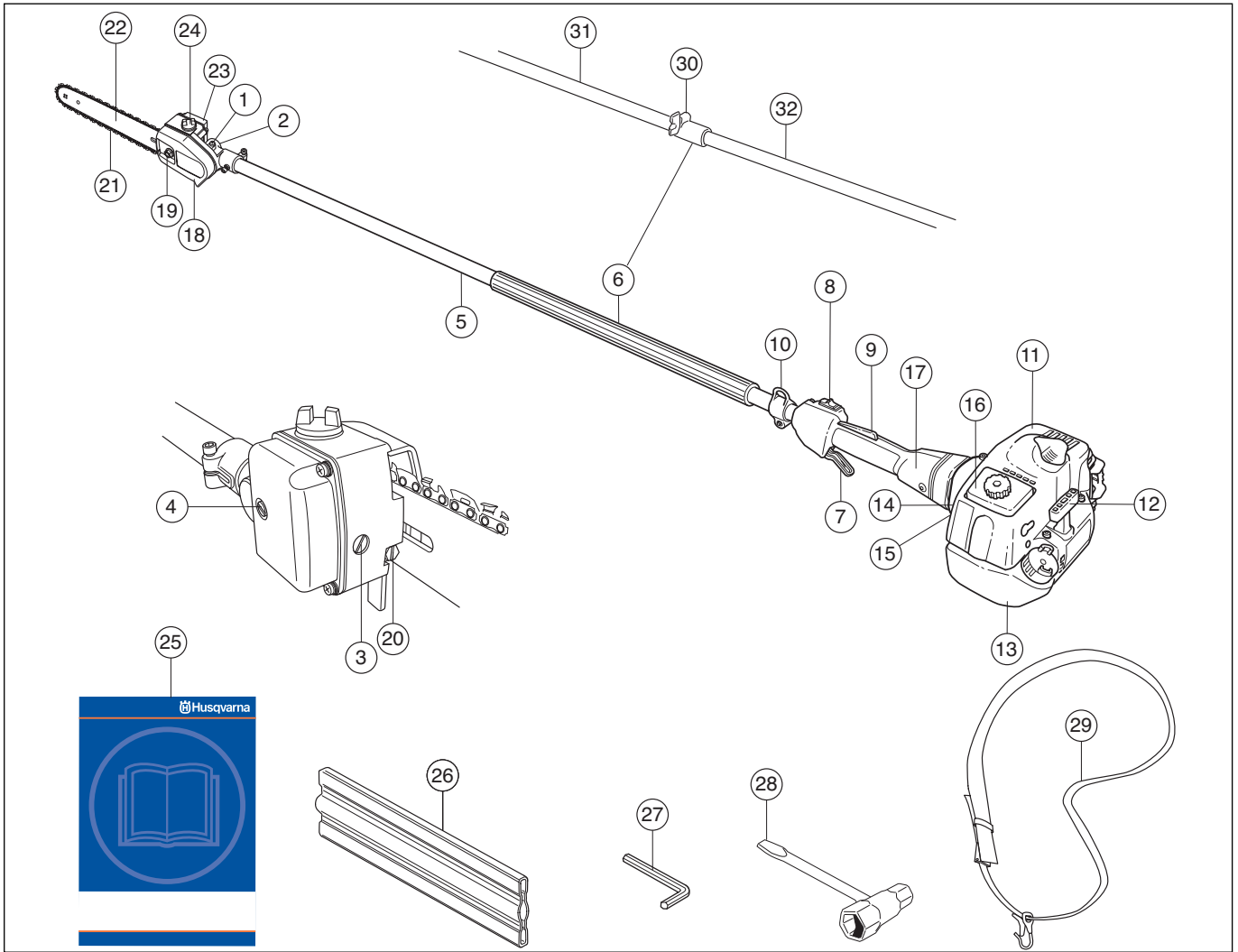

## What is what?

- |  |                                   |
|--|-----------------------------------|
| 1 Grease filler cap                      | 17 Clutch cover                   |
| 2 Bevel gear                             | 18 Protective guard for saw chain |
| 3 Chain lubrication adjustment screw (B) | 19 Bar nut                        |
| 4 Chain lubrication locking screw (A)    | 20 Chain tensioning screw         |
| 5 Shaft                                  | 21 Chain                          |
| 6 Front handle                           | 22 Bar                            |
| 7 Throttle control                       | 23 Chain oil tank                 |
| 8 Stop switch                            | 24 Filling with chain oil         |
| 9 Throttle lock                          | 25 Operator's manual (EPA)        |
| 10 Harness support hook                  | 26 Transport guard                |
| 11 Cylinder cover                        | 27 Allen key                      |
| 12 Starter handle                        | 28 Combination spanner            |
| 13 Fuel tank                             | 29 Harness                        |
| 14 Choke control                         | 30 Shaft coupling (325P5)         |
| 15 Air purge                             | 31 Upper shaft (325P5)            |
| 16 Air filter cover                      | 32 Lower shaft (325P5)            |

# ASSEMBLY

## Fitting the cutting head



- Fit the cutting head on the shaft so that the screw (A) is aligned with the hole in the shaft as shown.
- Tighten screw A.
- Tighten screw B.

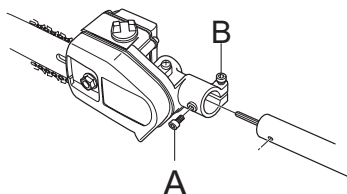

**CAUTION!** Make sure that the drive shaft inside the shaft engages with the cut-out in the cutting head.

## Fitting the bar and chain



Unscrew the bar nut and remove the protective cover.

Fit the bar over the bar bolt. Place the bar in its rearmost position. Place the chain over the drive sprocket and in the groove on the bar. Begin on the top side of the bar.

Make sure that the edges of the cutting links are facing forward on the top edge of the bar.

Fit the cover and locate the chain adjuster pin (A) in the hole in the bar. Check that the drive links of the chain fit correctly on the drive sprocket (B) and that the chain is in the groove in the bar (C). Tighten the bar nut finger-tight.

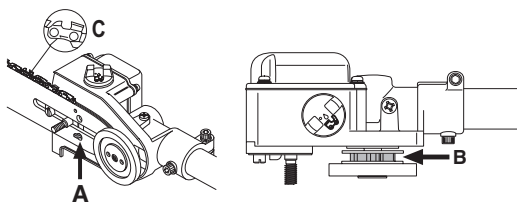

Tension the chain by turning the chain tensioning screw clockwise using the combination spanner. The chain should be tensioned until it does not sag from the underside of the bar.

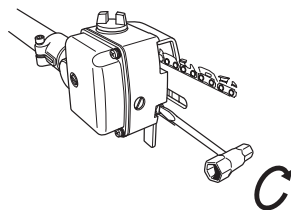

- The chain is correctly tensioned when there is no slack on the underside of the bar, and it can still be turned easily by hand. Tighten the bar nut with the combination spanner while holding up the tip of the bar.

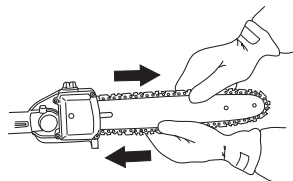

- When fitting a new chain, the chain tension has to be checked frequently until the chain is run-in. Check the chain tension regularly. A correctly tensioned chain ensures good cutting performance and long life.

## Adjusting the harness



You should always use the harness with the machine to give maximum control over the machine and reduce the risk of fatigue in your arms and back.

- Put on the harness.
- Hook the machine onto the harness support hook.
- Adjust the length of the harness so that the support hook is roughly level with your right hip.



## Filling with oil



- Open the cap on top of the bar head

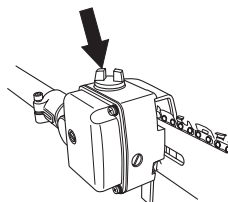

- Fill with Husqvarna saw chain oil.
- Refit the cap.



## Assembling and dismantling the two-piece shaft

(325P5)



### Assembly:

- Make sure the knob is loose.
- Align the cut-out in the upper shaft with the coupling's lock plate on the lower shaft. The parts then lock together.

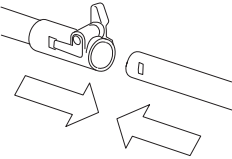

- Tighten the knob.

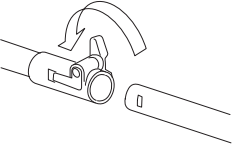

### Dismantling:

Undo the knob (at least three turns).

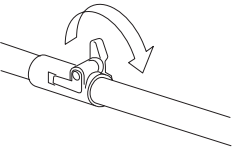

- Push the knob towards the coupling.
- Carefully twist the upper shaft to unlock it.
- Hold both parts of the shaft and pull the upper shaft out of the coupling.

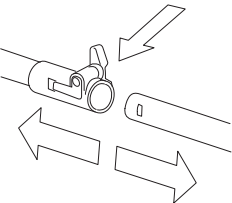

# FUEL HANDLING

## Fuel

CAUTION! The machine is equipped with a two-stroke engine and must always be run using a mixture of gasoline and two-stroke engine oil. It is important to accurately measure the amount of oil to be mixed to ensure that the correct mixture is obtained. When mixing small amounts of fuel, even small inaccuracies can drastically affect the ratio of the mixture.

**WARNING! Always ensure there is adequate ventilation when handling fuel.**

## Gasoline



CAUTION!

Always use high grade unleaded oil mixed gasoline (minimum 87 RON). If your machine is equipped with a catalytic converter (see chapter on Technical data) always use a good quality unleaded petrol/oil mixture. Leaded petrol will destroy the catalytic converter and it will no longer serve its purpose.

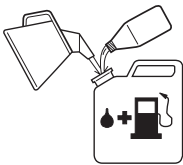

- **This engine is certified to operate on unleaded gasoline.**
- The lowest recommended octane rating is 87. If you run the engine on lower octane rating than 87 so-called "knocking" can occur. This leads to an increased engine temperature, which can result in a serious engine breakdown.
- When working at continuous high revs a higher octane rating is recommended.

## Two-stroke oil

- For best results and performance use HUSQVARNA two-stroke oil, which is specially formulated for our two-stroke engines. Mixture 1:50 (2%).
- Never use two-stroke oil intended for water-cooled outboard engines, sometimes referred to as outboard oil.
- Never use oil intended for four-stroke engines.

| Gasoline, litre | Two-stroke oil, litre |
|-----------------|-----------------------|
|                 | <b>2% (1:50)</b>      |
| 5               | 0,10                  |
| 10              | 0,20                  |
| 15              | 0,30                  |
| 20              | 0,40                  |
| US gallon       | US fl. oz.            |
| 1               | 2 1/2                 |
| 2 1/2           | 6 1/2                 |
| 5               | 12 7/8                |

## Mixing

- Always mix the gasoline and oil in a clean container intended for fuel.

- Always start by filling half the amount of the gasoline to be used. Then add the entire amount of oil. Mix (shake) the fuel mixture. Add the remaining amount of gasoline.
- Mix (shake) the fuel mixture thoroughly before filling the machine's fuel tank.

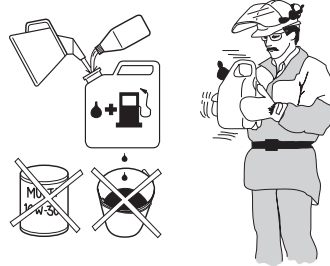

- Do not mix more than one month's supply of fuel at a time.
- If the machine is not used for some time the fuel tank should be emptied and cleaned.
- **This engine is certified to operate on unleaded gasoline.**

**WARNING! The catalytic converter muffler gets very hot during and after use. This also applies during idling. Be aware of the fire hazard, especially when working near flammable substances and/or vapours.**

## Fuelling



**WARNING! Taking the following precautions, will lessen the risk of fire:**

**Do not smoke or place hot objects near fuel.**

**Always shut off the engine before refuelling.**

**Always stop the engine and let it cool for a few minutes before refuelling.**

**When refuelling, open the fuel cap slowly so that any excess pressure is released gently.**

**Tighten the fuel cap carefully after refuelling.**

**Always move the machine away from the refuelling area before starting.**

- Move the machine at least 3 m from the refuelling point before starting it.

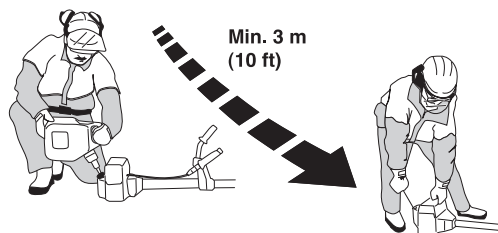

- Clean the area around the fuel cap. Contamination in the tank can cause operating problems.
- Ensure that the fuel is well mixed by shaking the container before filling the tank.

# STARTING AND STOPPING

## Check before starting

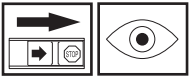

- Inspect the working area. Remove any objects that could be thrown out.
- Check the cutting attachment. Never use blunt, cracked or damaged equipment.
- Check that the machine is in perfect working order. Check that all nuts and screws are tight.
- Make sure the chain is adequately lubricated. See instructions under the heading Lubricating the cutting attachment.
- Check that the cutting attachment always stops when the engine is idling.
- Only use the machine for the purpose it was intended for.
- Make sure that the handle and safety features are in good working order. Never use a machine that lacks a part or has been modified outside its specifications.



## Starting and stopping



**WARNING!** The complete clutch cover and shaft must be fitted before the machine is started, otherwise the clutch can come loose and cause personal injury.

Always move the machine away from the refuelling area before starting. Place the machine on a flat surface. Ensure the cutting attachment cannot come into contact with any object. Make sure no unauthorised persons are in the working area, otherwise there is a risk of serious personal injury. The safety distance is 15 metres.

## Cold engine

**Ignition:** Set the stop switch to the start position.

**Choke:** Set the choke control in the choke position.

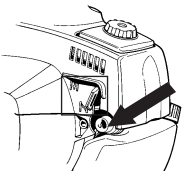

**Air purge:** Press the air purge diaphragm repeatedly until fuel begins to fill the diaphragm. The diaphragm need not be completely filled.

## Warm engine

Use the same procedure as for starting a cold engine but without setting the choke control in the choke position. The correct choke/start throttle setting is obtained by moving the choke control to the choke position and then pushing it in again.

## Stopping

Stop the engine by switching off the ignition.

**WARNING!** When the engine is started with the choke in the choke or start position the cutting attachment starts to rotate immediately.

## Starting



Hold the body of the machine on the ground using your left hand (CAUTION! Not with your foot!).

Grip the starter handle, slowly pull out the cord with your right hand until you feel some resistance (the starter pawls grip), now quickly and powerfully pull the cord.

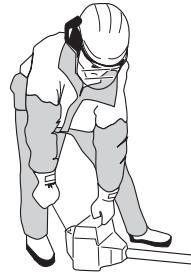

Push the choke control back to its original position as soon as the engine fires, and continue trying to start until the engine starts. When the engine starts, quickly apply full throttle to automatically disengage the start throttle setting.

**CAUTION!** Do not pull the starter cord all the way out and do not let go of the starter handle when the cord is fully extended. This can damage the machine. Also take care to ensure that the cutting attachment is not touching the ground when you start the machine.

# MAINTENANCE

## Carburettor

Your Husqvarna product has been designed and manufactured to specifications that reduce harmful emissions. After the engine has used 8-10 tanks of fuel the engine will be run-in. To ensure that it continues to run at peak performance and to minimise harmful exhaust emissions after the running-in period, ask your dealer/service workshop (who will have a rev counter at their disposal) to adjust your carburettor.



**WARNING!** The complete clutch cover and shaft must be fitted before the machine is started, otherwise the clutch can come loose and cause personal injury.

## Function



- The carburettor governs the engine's speed via the throttle control. Air and fuel are mixed in the carburettor. The air/fuel mixture is adjustable. Correct adjustment is essential to get the best performance from the machine.
- The setting of the carburetor means that the engine is adapted to local conditions, for example, the climate, altitude, fuel and the type of 2-stroke oil.
- The carburettor has three adjustment controls:

L = Low speed jet

H = High speed jet

T = Idle adjustment screw

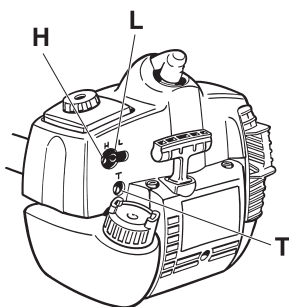

- The L and H-jets are used to adjust the supply of fuel to match the rate that air is admitted, which is controlled with the throttle. If they are screwed clockwise the air/fuel ratio becomes leaner (less fuel) and if they are turned anti-clockwise the ratio becomes richer (more fuel). A lean mixture gives a higher engine speed and a rich mixture gives a lower engine speed.
- The T-screw regulates the throttle setting at idle speed. If the T-screw is turned clockwise this gives a higher idle speed; turning it anti-clockwise gives a lower idle speed.

## Basic setting

- The basic carburettor settings are adjusted during testing at the factory. The basic setting is richer than the optimal setting and should be maintained for the first few hours the machine is in use. The carburettor should then be finely adjusted. Fine adjustment should be carried out by a skilled technician.

**CAUTION!** If the cutting attachment rotates when the engine is idling the idle adjustment screw T should be turned anti-clockwise until the cutting attachment stops.

**Rec. idle speed** 2700 rpm

**Recommended max. speed:** See the Technical data section.



**WARNING!** If the idle speed cannot be adjusted so that the cutting attachment stops, contact your dealer/service workshop. Do not use the machine until it has been correctly adjusted or repaired.

## Fine adjustment

- When the machine has been "run-in" the carburettor should be finely adjusted. **The fine adjustment should be carried out by a qualified person.** First adjust the L-jet, then the idling screw T and then the H-jet.

## Conditions

- Before any adjustments are made, make sure that the air filter is clean and the air filter cover is fitted. If you adjust the carburettor when the air filter is dirty it will result in a leaner mixture when the filter is finally cleaned. This can lead to serious engine damage.
- Carefully turn both jets, L and H, so that they are midway between fully screwed in and fully screwed out.
- Do not attempt to adjust the L and H jets beyond either stop as this could cause damage.
- Now start the machine according to the starting instructions and let it warm up for 10 minutes.

**CAUTION!** If the cutting attachment rotates when the engine is idling the idle adjustment screw T should be turned anti-clockwise until the cutting attachment stops.

## Low speed jet L

Try to find the highest idling speed, turning the low speed needle L clockwise respectively counter-clockwise. When the highest speed has been found, turn the low speed needle L 1/4 turn counter-clockwise.

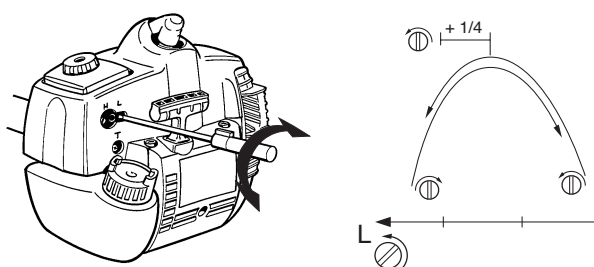

**CAUTION!** If the cutting attachment rotates when the engine is idling the idle adjustment screw T should be turned anti-clockwise until the cutting attachment stops.

# MAINTENANCE

## Fine adjustment of the idle speed T

Adjust the idle speed using the idle adjustment screw T, if it is necessary to readjust. First turn the idle adjustment screw T clockwise until the cutting attachment starts to rotate. Then turn the screw anticlockwise until the cutting attachment stops. The idle speed is correctly adjusted when the engine will run smoothly in every position. The idle speed should also be well below the speed at which the cutting attachment starts to rotate.

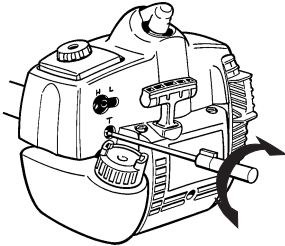

**IMPORTANT!** If the idle speed cannot be adjusted so that the cutting attachment stops, contact your dealer/service workshop. Do not use the machine until it has been correctly adjusted or repaired.

## High speed jet H

The high speed jet H affects the engine power, speed, temperature and fuel consumption. If the high speed jet H is set too lean (screwed in too far) the engine speed will be too high and cause engine damage. Do not let the engine run at full speed for more than 10 seconds.

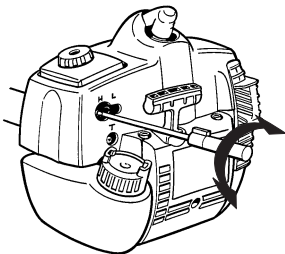

Apply full throttle and turn the high speed jet H very slowly clockwise until the engine slows down. Then turn the high speed jet H very slowly anticlockwise until the engine starts to run unevenly. Now turn the high speed jet H slowly clockwise a little way until the engine runs smoothly.

Note that the engine should not be under load when you adjust the high speed jet H. You should therefore remove the cutting attachment, nut, support flange and drive disc before adjusting the high speed jet H.

The high speed jet H is adjusted correctly when the machine burbles a little. If the machine races then the setting is too lean. If the engine produces a lot of smoke and burbles a lot then the setting is too rich.

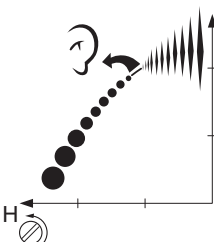

**CAUTION!** For optimum adjustment of the carburettor, contact a qualified dealer/service workshop that has a revolution counter at their disposal.

## Correctly adjusted carburettor

When the carburettor is correctly adjusted the machine will accelerate without hesitation and burble a little at maximum speed. It is also important that the cutting attachment does not rotate at idle. If the low speed jet L is set too lean it may cause starting difficulties and poor acceleration.

If the high speed jet H is set too lean it will result in less power, less performance, poor acceleration and/or damage to the engine.

If both the L and H jets are set too rich it will result in acceleration problems or too low a working speed.

## Muffler

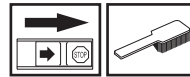

**CAUTION!** Some mufflers are fitted with a catalytic converter. See chapter on Technical data to see whether your machine is fitted with a catalytic converter.

The muffler is designed to reduce the noise level and to direct the exhaust gases away from the operator. The exhaust gases are hot and can contain sparks, which may cause fire if directed against dry and combustible material.

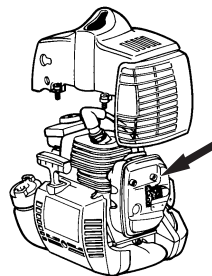

Some mufflers are equipped with a special spark arrestor mesh. If your machine has this type of muffler, you should clean the mesh at least once a week. This is best done with a wire brush.



On mufflers without a catalytic converter the mesh should be cleaned weekly, or replaced if necessary. On mufflers fitted with a catalytic converter the mesh should be checked, and if necessary cleaned, monthly. **If the mesh is damaged it should be replaced.**

If the mesh is frequently blocked, this can be a sign that the performance of the catalytic converter is impaired. Contact your dealer to inspect the muffler. A blocked mesh will cause the machine to overheat and result in damage to the cylinder and piston. See also instructions under the heading Maintenance.

# MAINTENANCE

**CAUTION!** Never use a machine with a defective muffler.



**WARNING!** Mufflers fitted with catalytic converters get very hot during use and remain so for some time after stopping. This also applies at idle speed. Contact can result in burns to the skin. Remember the risk of fire!

## Cooling system

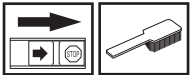

To keep the working temperature as low as possible the machine is equipped with a cooling system.

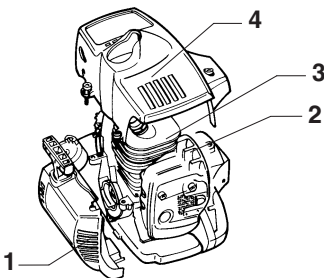

The cooling system consists of:

- 1 Air intake on the starter.
- 2 Fins on the flywheel.
- 3 Cooling fins on the cylinder.
- 4 Cylinder cover (directs cold air over the cylinder).

Clean the cooling system with a brush once a week, more often in demanding conditions. A dirty or blocked cooling system results in the machine overheating which causes damage to the piston and cylinder.

## Spark plug



The spark plug condition is influenced by:

- Incorrect carburettor adjustment.
- An incorrect fuel mixture (too much or incorrect type of oil).
- A dirty air filter.

These factors cause deposits on the spark plug electrodes, which may result in operating problems and starting difficulties.

If the machine is low on power, difficult to start or runs poorly at idle speed: always check the spark plug first before taking any further action. If the spark plug is dirty, clean it and check

that the electrode gap is 0.5 mm (0,020"). The spark plug should be replaced after about a month in operation or earlier if necessary.

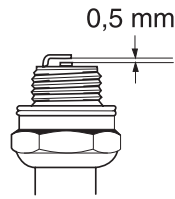

**CAUTION!** Always use the recommended spark plug type! Use of the wrong spark plug can damage the piston/cylinder.

## Air filter

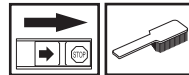

The air filter must be regularly cleaned to remove dust and dirt in order to avoid:

- Carburettor malfunctions
- Starting problems
- Loss of engine power
- Unnecessary wear to engine parts
- Excessive fuel consumption.

Clean the filter every 25 hours, or more regularly if conditions are exceptionally dusty.

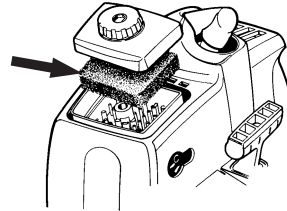

## Cleaning the air filter

Remove the air filter cover and take out the filter. Wash it clean in warm, soapy water. Ensure that the filter is dry before refitting it.

An air filter that has been in use for a long time cannot be cleaned completely. The filter must therefore be replaced with a new one at regular intervals. **A damaged air filter must always be replaced.**

If the machine is used in dusty conditions the air filter should be soaked in oil. See instructions under the heading Oiling the air filter.

# MAINTENANCE

## Oiling the air filter

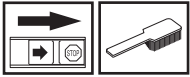

Always use HUSQVARNA filter oil, art. no. 503 47 73-01. The filter oil contains a solvent to make it spread evenly through the filter. You should therefore avoid skin contact.

Put the filter in a plastic bag and pour the filter oil over it. Knead the plastic bag to distribute the oil. Squeeze the excess oil out of the filter inside the plastic bag and pour off the excess before fitting the filter to the machine. Never use common engine oil. This would drain through the filter quite quickly and collect in the bottom.

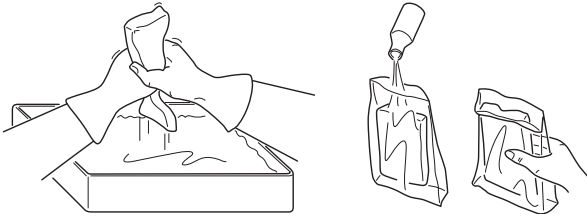

## Bevel gear

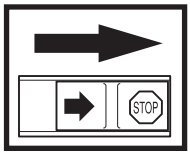

The bevel gear is filled with the right quantity of grease at the factory. However, before using the machine you should check that the bevel gear is filled three-quarters full with grease. Use HUSQVARNA special grease.

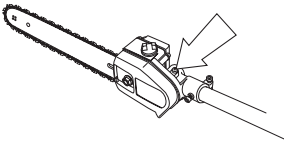

The grease in the bevel gear does not normally need to be changed except if repairs are carried out.

## Maintenance schedule

Below you will find some general maintenance instructions. If you need further information please contact your service workshop.

### Daily maintenance

- Clean the outside of the machine.
- Check throttle trigger and throttle trigger lockout function.
- Check that the stop switch works correctly.
- Check that the cutting attachment does not rotate at idle.
- Check that the harness is undamaged.
- Check that nuts and screws are tight.
- Check that there are no fuel leaks.
- Clean the area under the protective cover.

### Weekly maintenance

- Check the starter, the starter cord and the recoil spring.
- Clean the air filter.
- Clean the carburettor compartment.
- Clean the outside of the spark plug. Remove and check the electrode gap. Adjust the gap to 0.5 mm or change the spark plug.
- Clean the cooling fins on the cylinder and check that the air intake near the starter is not blocked.
- Clean or replace the spark arrestor mesh on the muffler (only applies to mufflers without a catalytic converter).
- File off any burrs from the edges of the bar.

### Monthly maintenance

- Clean the fuel tank.
- Clean the outside of the carburettor and the space around it.
- Clean the fan and the area around it.
- Check fuel hose for cracks or other damage. Change if necessary.
- Check all cables and connections.
- Check the clutch, clutch springs and the clutch drum for wear. Replace if necessary.
- Replace the spark plug. Check that the spark plug is fitted with a suppressor.
- Replace the air filter.
- Check and clean the spark arrestor mesh on the muffler (only applies to mufflers fitted with a catalytic converter).

---

# TECHNICAL DATA

---

## Technical data

| Technical data  | 323P4             | 325P5             |
|---|-------------------|-------------------|
| <b>Engine</b>   |                   |                   |
| Cylinder volume, cu.in/cm <sup>3</sup>  | 1,50/24,5         | 1,50/24,5         |
| Cylinder bore, inch/mm  | 1,34/34           | 1,34/34           |
| Stroke, inch/mm   | 1,06/27           | 1,06/27           |
| Recommended max. speed, rpm   | 11000-11700       | 11000-11700       |
| Idle speed, rpm   | 2700              | 2700              |
| Max. engine output, acc. to ISO 8893  | 0,9/9000          | 0,9/9000          |
| Catalytic converter muffler   | No                | Yes               |
| Speed-regulated ignition system   | Yes               | Yes               |
| <b>Ignition system</b>  |                   |                   |
| Manufacturer/type of ignition system  | WalbroMB/SEM AM49 | WalbroMB/SEM AM49 |
| Spark plug  | NGK BPMR 7A       | NGK BPMR 7A       |
| Electrode gap, inch/mm  | 0,02/0,5          | 0,02/0,5          |
| <b>Fuel and lubrication system</b>  |                   |                   |
| Manufacturer/type of carburettor  | Zama C1Q          | Zama C1Q          |
| Fuel tank capacity, US pint/litre   | 0,02/0,5          | 0,02/0,5          |
| <b>Chain lubrication system</b>   |                   |                   |
| Oil tank capacity, US pint/litre  | 0,17              | 0,17              |
| <b>Weight</b>   |                   |                   |
| Weight without fuel, cutting attachment and guard, Lbs/kg   | 5,0               | 5,1               |
| <b>Sound levels</b>   |                   |                   |
| (see note 1)  |                   |                   |
| Equivalent noise pressure level at the user's ear, measured according to EN/ISO 11680-1, dB(A)            | 94                | 92                |
| Equivalent noise power level at the user's ear, measured according to EN/ISO 11680-1 and ISO 10884, dB(A) | 107               | 105               |
| <b>Vibration levels</b>   |                   |                   |
| Vibration levels on the handles, measured according to EN/ISO 11680-1, m/s <sup>2</sup>                   |                   |                   |
| Idle speed, rear/front handles:   | 1,3/1,9           | 2,2/2,6           |
| Max. speed, rear/front handles:   | 4,0/3,1           | 6,6/7,5           |

Note 1: Equivalent sound pressure level is calculated as the time-weighted energy total for sound pressure levels under various working conditions with the following time distribution: 1/2 idling and 1/2 max speed.







# TECHNICAL DATA

## Bar and chain combinations

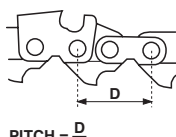
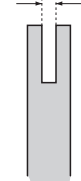
The following combinations are CE approved.

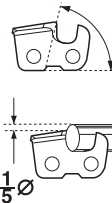
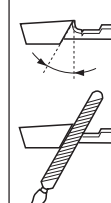
| Length, inches | Bar         |                                  | Chain                           |
|----------------|-------------|----------------------------------|---------------------------------|
|                | Pitch, inch | Max. no of teeth on tip sprocket |                                 |
| 10             | 3/8         | 7T                               | Husqvarna S 36/<br>Oregon 91 VG |
| 12             | 3/8         | 7T                               | Husqvarna S 36/<br>Oregon 91 VG |
| 10             | 3/8         | 7T                               | Oregon 90SG                     |
| 12             | 3/8         | 7T                               | Oregon 90SG                     |

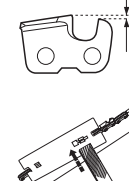
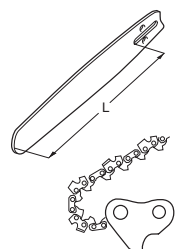
|      |  |  |  |  |  |  |  |  |
|------|---|---|---|---|---|--|---|---|
|      | inch  | inch/mm   | inch/mm   |   |   |  | inch/mm   | inch/cm: dl   |
| 91VG | 3/8"  | 0,050"/1,3  | 5/32" /4,0  | 85°   | 30°   | 0°   | 0,025"/0,65   | 10"/25:40<br>12"/30:45  |
| S36  | 3/8"  | 0,050"/1,3  | 5/32" /4,0  | 85°   | 30°   | 0°   | 0,025"/0,65   | 10"/25:40<br>12"/30:45  |
| 90SG | 3/8"  | 0,043"/1,1  | 5/32" /4,0  | 85°   | 30°   | 0°   | 0,025"/0,65   | 10"/25:40<br>12"/30:45  |

# FEDERAL EMISSION CONTROL WARRANTY STATEMENT

## YOUR WARRANTY RIGHTS AND OBLIGATIONS

The EPA (The US Environmental Protection Agency), Environment Canada and Husqvarna Forest & Garden are pleased to explain the emissions control system warranty on your 2001 and later small nonroad engine. In U.S. and Canada, new small nonroad engines must be designed, built and equipped to meet the federal stringent anti-smog standards. Husqvarna Forest & Garden must warrant the emission control system on your small nonroad engine for the period of time listed below provided there has been no abuse, neglect or improper maintenance of your unit. Your emission control system includes Parts such as the carburetor and the ignition system. Where a warrantable condition exists, Husqvarna Forest & Garden will repair your small nonroad engine at no cost to you. Expenses covered under warranty include diagnosis, parts and labor.

## MANUFACTURER'S WARRANTY COVERAGE

The 2001 and later small nonroad engines are warranted for two years. If any emission related part on you engine (as listed above) is defective, the part will be repaired or replaced by Husqvarna Forest & Garden.

## OWNER'S WARRANTY RESPONSIBILITIES

As the small nonroad engine owner, you are responsible for the performance of the required maintenance listed in your Operator's Manual. Husqvarna Forest & Garden recommends that you retain all receipts covering maintenance on your small nonroad engine, but Husqvarna Forest & Garden cannot deny warranty solely for the lack of receipts or for your failure to ensure the performance of all scheduled maintenance. As the small nonroad engine owner, you should, however, be aware that Husqvarna Forest & Garden may deny you warranty coverage if your small nonroad engine or a part of it has failed due to abuse, neglect, improper maintenance, unapproved modifications or the use of parts not made or approved by the original equipment manufacturer. You are responsible for presenting your small nonroad engine to a Husqvarna Forest & Garden authorized servicing dealer as soon as a problem exists. The warranty repairs should be completed in a reasonable amount of time, not to exceed 30 days. If you have any questions regarding your warranty rights and responsibilities, you should contact your nearest authorized servicing dealer or call Husqvarna Forest & Garden at 1-800-487-5963

## WARRANTY COMMENCEMENT DATE

The warranty period begins on the date small nonroad engine is delivered.

## LENGTH OF COVERAGE

Husqvarna Forest & Garden warrants to the initial owner and each subsequent purchaser that the engine is free from defects in materials and workmanship which cause the failure of a warranted part for a period of two years.

## WHAT IS COVERED

**REPAIR OR REPLACEMENT OF PARTS** Repair or replacement of any warranted part will be performed at no charge to the owner at an approved Husqvarna Forest &

Garden servicing dealer. If you have any questions regarding your warranty rights and responsibilities, you should contact your nearest authorized servicing dealer or call Husqvarna Forest & Garden at 1-800-487-5963

**WARRANTY PERIOD** Any warranted part which is not scheduled for replacement as required maintenance, or which is scheduled only for regular inspection to the effect of "repair or replace as necessary" shall be warranted for 2 years. Any warranted part which is scheduled for replacement as required maintenance shall be warranted for the period of time up to the first scheduled replacement point for that part.

**DIAGNOSIS** The owner shall not be charged for diagnostic labor which leads to the determination that a warranted part is defective, if the diagnostic work is performed at an approved Husqvarna Forest & Garden servicing dealer.

**CONSEQUENTIAL DAMAGES** Husqvarna Forest & Garden may be liable for damages to other engine components caused by the failure of a warranted part still under warranty.

## WHAT IS NOT COVERED

All failures caused by abuse, neglect or improper maintenance are not covered.

## ADD -ON OR MODIFIED PARTS

The use of add-on or modified parts can be grounds for disallowing a warranty claim. Husqvarna Forest & Garden is not liable to cover failures of warranted parts caused by the use of add-on or modified parts.

## HOW TO FILE A CLAIM

If you have any questions regarding your warranty rights and responsibilities, you should contact your nearest authorized servicing dealer or call Husqvarna Forest & Garden at 1-800-487-5963

## WHERE TO GET WARRANTY SERVICE

Warranty services or repairs shall be provided at all Husqvarna Forest & Garden authorized servicing dealers.

## MAINTENANCE, REPLACEMENT AND REPAIR OF EMISSION-RELATED PARTS

Any Husqvarna Forest & Garden approved replacement part used in the performance of any warranty maintenance or repairs on emission-related parts, will be provided without charge to the owner if the part is under warranty.

## EMISSION CONTROL WARRANTY PARTS LIST

- 1 Carburetor and internal parts
- 2 Intake pipe, airfilter holder and carburetor bolts.
- 3 Airfilter and fuelfilter covered up to maintenance schedule.
- 4 Ignition System
  - 1 Spark Plug, covered up to maintenance schedule
  - 2 Ignition Module
- 5 Muffler with catalytic converter

## MAINTENANCE STATEMENT

The owner is responsible for the performance of all required maintenance, as defined in the operator's manual.











1140167-95



2003-03-19