

Operator's manual
323HD60 325HD60**X-series**
325HD75**X-series**

Please read the operator's manual carefully and make sure you understand the instructions before using the machine.



English

KEY TO SYMBOLS

Symbols

WARNING! Incorrect or careless use of a hedge trimmer can turn it into a dangerous tool that can cause serious or even fatal injury. It is extremely important that you read and understand the contents of this operator's manual.



Please read the operator's manual carefully and make sure you understand the instructions before using the machine.



Always wear:

- Approved hearing protection
- Approved eye protection



This product is in accordance with applicable EC directives.



Always wear approved protective gloves.



Wear sturdy, non-slip boots or shoes.



Noise emission to the environment according to the European Community's Directive. The machine's emission is specified in chapter Technical data and on label.



Other symbols/decals on the machine refer to special certification requirements for certain markets.

The engine is switched off by moving the stop switch to the stop position. **CAUTION!** The stop switch automatically returns to the start position. In order to prevent unintentional starting, the spark plug cap must be removed from the spark plug when assembling, checking and/or performing maintenance.

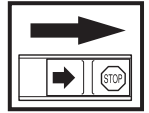

Always wear approved protective gloves.

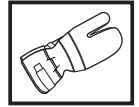

Regular cleaning is required.

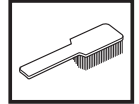

Visual check.



Protective goggles or a visor must be worn.



CONTENTS

Contents

KEY TO SYMBOLS

Symbols 2

CONTENTS

Contents 3

Note the following before starting: 3

INTRODUCTION

Dear Customer, 4

WHAT IS WHAT?

What is what? 5

GENERAL SAFETY PRECAUTIONS

Important 6

Personal protective equipment 6

Machine's safety equipment 7

FUEL HANDLING

Fuel safety 10

Fuel 10

Fuelling 11

STARTING AND STOPPING

Check before starting 12

Starting and stopping 12

WORKING TECHNIQUES

General working instructions 14

MAINTENANCE

Carburettor 16

Muffler 17

Cooling system 18

Spark plug 18

Air filter 18

Gear housing 19

Cleaning and lubrication 19

Maintenance schedule 20

TECHNICAL DATA

Technical data 21

EC-declaration of conformity (Applies to Europe only) . 22

Note the following before starting:

Please read the operator's manual carefully.

Long-term exposure to noise can result in permanent hearing impairment. So always use approved hearing protection.



WARNING! Under no circumstances may the design of the machine be modified without the permission of the manufacturer. Always use genuine accessories. Non-authorized modifications and/or accessories can result in serious personal injury or the death of the operator or others.



WARNING! Incorrect or careless use of a hedge trimmer can turn it into a dangerous tool that can cause serious or even fatal injury. It is extremely important that you read and understand the contents of this operator's manual.

INTRODUCTION

Dear Customer,

Congratulations on your choice to buy a Husqvarna product! Husqvarna is based on a tradition that dates back to 1689, when the Swedish King Charles XI ordered the construction of a factory on the banks of the Husqvarna River, for production of muskets. The location was logical, since water power was harnessed from the Huskvarna River to create the water-powered plant. During the more than 300 years of being, the Husqvarna factory has produced a lot of different products, from wood stoves to modern kitchen appliances, sewing machines, bicycles, motorcycles etc. In 1956, the first motor driven lawn mowers appeared, followed by chain saws in 1959, and it is within this area Husqvarna is working today.

Today Husqvarna is one of the leading manufacturers in the world of forest and garden products, with quality as our highest priority. The business concept is to develop, manufacture and market motor driven products for forestry and gardening as well as for building and construction industry. Husqvarna's aim is also to be in the front edge according to ergonomics, usability, security and environmental protection. That is the reason why we have developed many different features to provide our products within these areas.

We are convinced that you will appreciate with great satisfaction the quality and performance of our product for a very long time to come. The purchase of one of our products gives you access to professional help with repairs and service whenever this may be necessary. If the retailer who sells your machine is not one of our authorised dealers, ask for the address of your nearest service workshop.

It is our wish that you will be satisfied with your product and that it will be your companion for a long time. Think of this operator's manual as a valuable document. By following its' content (using, service, maintenance etc) the life span and the second-hand value of the machine can be extended. If you will sell this machine, make sure that the buyer will get the operator's manual.

Thank you for using a Husqvarna product.

Husqvarna AB has a policy of continuous product development and therefore reserves the right to modify the design and appearance of products without prior notice.

WHAT IS WHAT?

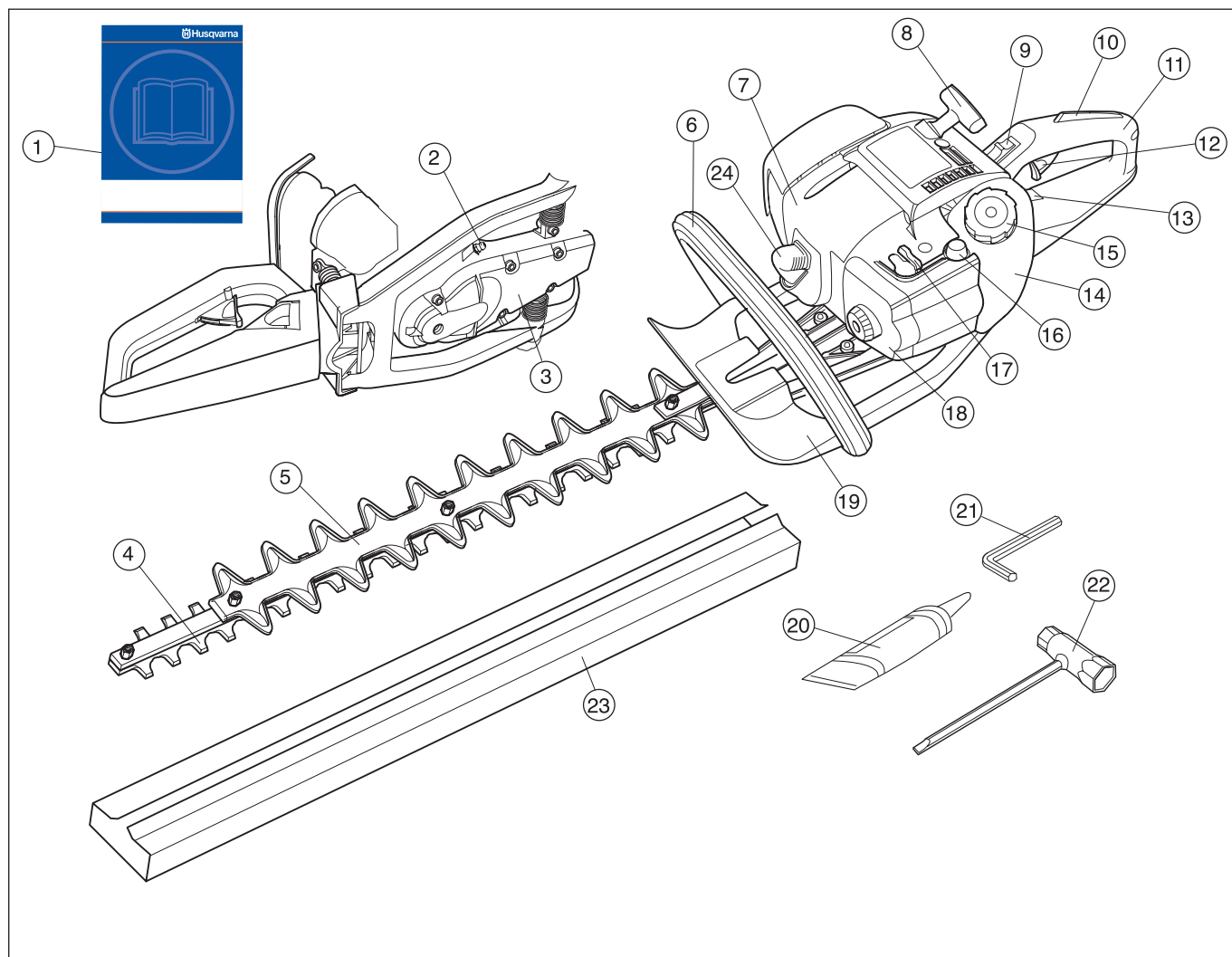

What is what?

- | | |
|---------------------------------|--|
| 1 Operator's manual | 13 Lock for handle (325HD60, 325HD75) |
| 2 Grease filler cap, bevel gear | 14 Fuel tank |
| 3 Gear housing | 15 Fuel cap |
| 4 Blades | 16 Air purge |
| 5 Blade guard | 17 Choke control |
| 6 Front handle | 18 Air filter cover. |
| 7 Cylinder cover | 19 Hand guard |
| 8 Starter handle | 20 Tube of grease |
| 9 Stop switch | 21 Allen key |
| 10 Throttle lock | 22 Combination spanner |
| 11 Adjustable handle | 23 Transport guard |
| 12 Throttle control | 24 Spark plug cap and spark plug |

GENERAL SAFETY PRECAUTIONS

Important

IMPORTANT!

The machine is only designed for cutting branches and twigs.

Never use a machine that has been modified in any way from its original specification.

Never use the machine if you are tired, if you have drunk alcohol, or if you are taking medication that could affect your vision, your judgement or your co-ordination.

Wear personal protective equipment. See instructions under the heading Personal protective equipment.

Never use the machine in extreme weather conditions such as severe cold, very hot and/or humid climates.

Never use a machine that is faulty. Carry out the checks, maintenance and service instructions described in this manual. Some maintenance and service measures must be carried out by trained and qualified specialists. See instructions under the heading Maintenance.

All covers and guards must be fitted before starting. Ensure that the spark plug cap and ignition lead are undamaged to avoid the risk of electric shock.



WARNING! Running an engine in a confined or badly ventilated area can result in death due to asphyxiation or carbon monoxide poisoning.



WARNING! Never allow children to use or be in the vicinity of the machine. As the machine is equipped with a spring-loaded stop switch and can be started by low speed and force on the starter handle, even small children under some circumstances can produce the force necessary to start the machine. This can mean a risk of serious personal injury. Therefore remove the spark plug cap when the machine is not under close supervision.



WARNING! Faulty blades can increase the risk of accidents.

Personal protective equipment

IMPORTANT!

Incorrect or careless use of a hedge trimmer can turn it into a dangerous tool that can cause serious or even fatal injury. It is extremely important that you read and understand the contents of this operator's manual.

You must use approved personal protective equipment whenever you use the machine. Personal protective equipment cannot eliminate the risk of injury but it will reduce the degree of injury if an accident does happen. Ask your dealer for help in choosing the right equipment.



WARNING! Listen out for warning signals or shouts when you are wearing hearing protection. Always remove your hearing protection as soon as the engine stops.

HEARING PROTECTION

Wear hearing protection that provides adequate noise reduction.



EYE PROTECTION

Always wear approved eye protection. If you use a visor then you must also wear approved protective goggles. Approved protective goggles must comply with standard ANSI Z87.1 in the USA or EN 166 in EU countries.

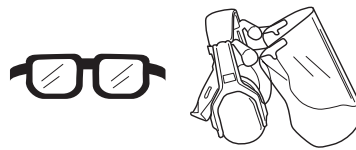

GLOVES

Gloves should be worn when necessary, e.g., when fitting cutting attachments.



BOOTS

Wear sturdy, non-slip boots or shoes.



CLOTHING

Wear clothes made of a strong fabric and avoid loose clothing that can catch on twigs and branches. Always wear heavy, long pants. Do not wear jewellery, shorts sandals or go barefoot. Secure hair so it is above shoulder level.

FIRST AID KIT

Always have a first aid kit nearby.



GENERAL SAFETY PRECAUTIONS

Machine's safety equipment

This section describes the machine's safety equipment, its purpose, and how checks and maintenance should be carried out to ensure that it operates correctly. See the "What is what?" section to locate where this equipment is positioned on your machine.

The life span of the machine can be reduced and the risk of accidents can increase if machine maintenance is not carried out correctly and if service and/or repairs are not carried out professionally. If you need further information please contact your nearest service workshop.

IMPORTANT!

All servicing and repair work on the machine requires special training. This is especially true of the machine's safety equipment. If your machine fails any of the checks described below you must contact your service agent. When you buy any of our products we guarantee the availability of professional repairs and service. If the retailer who sells your machine is not a servicing dealer, ask him for the address of your nearest service agent.



WARNING! Never use a machine with faulty safety equipment. The machine's safety equipment must be checked and maintained as described in this section. If your machine fails any of these checks contact your service agent to get it repaired.

Throttle lock

The throttle lock is designed to prevent accidental operation of the throttle control. When you press the lock (A) (i.e. when you grasp the handle) it releases the throttle control (B). When you release the handle the throttle control and the throttle lock both move back to their original positions. This movement is controlled by two independent return springs. This arrangement means that the throttle control is automatically locked at the idle setting.

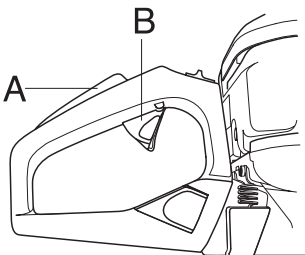

Make sure the throttle control is locked at the idle setting when the throttle lock is released.

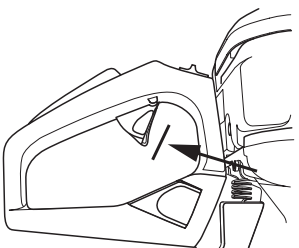

Press the throttle lock and make sure it returns to its original position when you release it.

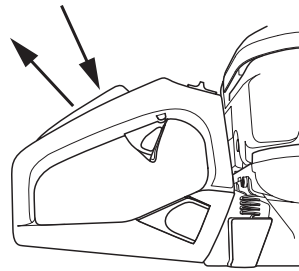

Check that the throttle control and throttle lock move freely and that the return springs work properly.

See instructions under the heading Start. Start the hedge trimmer and apply full throttle. Release the throttle trigger and check that the blades stop and remain stationary. If the blades move when the throttle trigger is in the idle position then the carburettor idle setting must be adjusted. See instructions under the heading Maintenance.



Stop switch

Use the stop switch to switch off the engine.

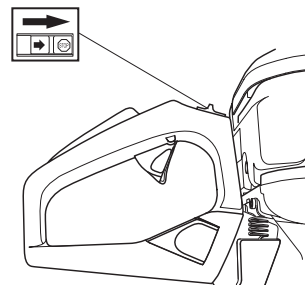

Start the engine and make sure the engine stops when you move the stop switch to the stop setting.

Hand guard

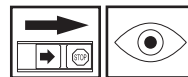

The hand guard prevents hands from coming into contact with the moving blades, for example, if the operator loses grip on the front handle.

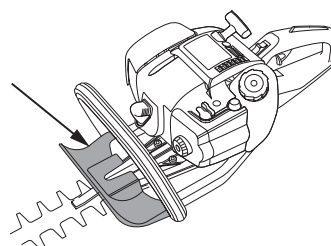

Check that the hand guard is fitted correctly.

Check that the hand guard is undamaged.

GENERAL SAFETY PRECAUTIONS

Vibration damping system

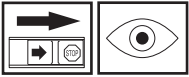

Your machine is equipped with a vibration damping system that is designed to minimize vibration and make operation easier.

The machine's vibration damping system reduces the transfer of vibration between the engine unit/cutting equipment and the machine's handle unit.

The engine body including the blades is suspended on the handlebar system via a four springs.

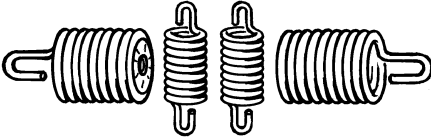

Regularly check the vibration damping units for cracks or deformation. Check that the vibration damping element is undamaged and securely attached.



WARNING! Overexposure to vibration can lead to circulatory damage or nerve damage in people who have impaired circulation. Contact your doctor if you experience symptoms of overexposure to vibration. Such symptoms include numbness, loss of feeling, tingling, pricking, pain, loss of strength, changes in skin colour or condition. These symptoms normally appear in the fingers, hands or wrists. The risk increases at low temperatures.

Muffler

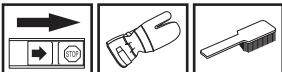

The muffler is designed to keep noise levels to a minimum and to direct exhaust fumes away from the user.

A muffler fitted with a catalytic converter is also designed to reduce harmful exhaust gases.



In countries that have a warm and dry climate there is a significant risk of fire. We therefore fit certain mufflers with a spark arrester mesh. Check whether the muffler on your machine is fitted with this kind of mesh.

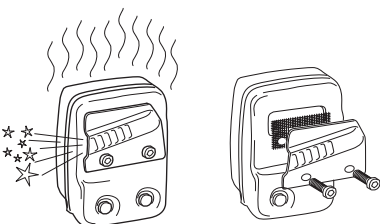

For mufflers it is very important that you follow the instructions on checking, maintaining and servicing your machine.

Never use a machine that has a faulty muffler.



Regularly check that the muffler is securely attached to the machine.

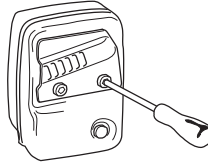

If the muffler on your machine is fitted with a spark arrester mesh this must be cleaned regularly. A blocked mesh will cause the engine to overheat and may lead to serious damage.

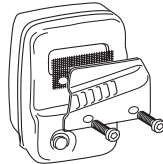

WARNING! Mufflers fitted with catalytic converters get very hot during use and remain so for some time after stopping. This also applies at idle speed. Contact can result in burns to the skin. Remember the risk of fire!



WARNING! The inside of the muffler contain chemicals that may be carcinogenic. Avoid contact with these elements in the event of a damaged muffler.



WARNING! Bear in mind that:

The exhaust fumes from the engine are hot and may contain sparks which can start a fire. Never start the machine indoors or near combustible material!

GENERAL SAFETY PRECAUTIONS

Blades



To ensure good cutting results it is important that the contact pressure between the blades is correct. The contact pressure is adjusted by turning the screws on the underside of the bar clockwise as far as they will go. Then turn the screws anticlockwise a 1/4 turn. Lock the screws using the locking nut on the top of the bar. Check that the screws are loose enough to allow the washers under the screw heads to slide sideways.

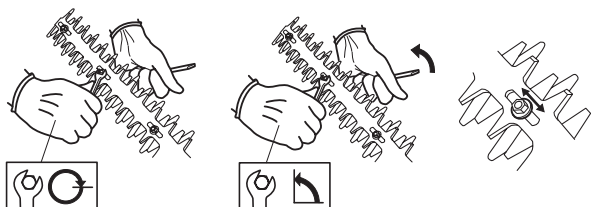

When the blades are correctly adjusted the play between the blades should be 0,2–0,4 mm, measured at the screws.

The edges of the blades are too hard to be filed. Dull blades should be sharpened using a grinder.

Replace the blades if they are bent or damaged.

Blade guard



The blade guard (A) is intended to protect against any part of the body coming into contact with the blades (B).

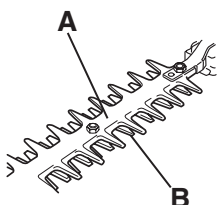

Check that the blade guard is not damaged or distorted. Replace the blade guard if it is bent or damaged.

Gear housing

The gear housing gets hot when the machine has been in use. To avoid burning yourself do not touch the gear housing.

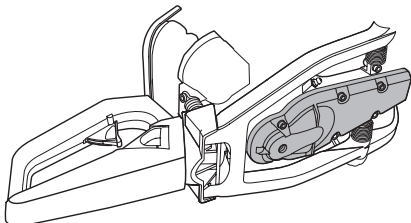

FUEL HANDLING

Fuel safety

Never start the machine:

- 1 If you have spilt fuel on it. Wipe off the spillage and allow remaining fuel to evaporate.
- 2 If you have spilt fuel on yourself or your clothes, change your clothes. Wash any part of your body that has come in contact with fuel. Use soap and water.
- 3 If the machine is leaking fuel. Check regularly for leaks from the fuel cap and fuel lines.

Transport and storage

- Store and transport the machine and fuel so that there is no risk of any leakage or fumes coming into contact with sparks or naked flames, for example, from electrical machinery, electric motors, electrical relays/switches or boilers.
- When storing and transporting fuel always use approved containers intended for this purpose.
- When storing the machine for long periods the fuel tank must be emptied. Contact your local petrol station to find out where to dispose of excess fuel.
- Ensure the machine is cleaned and that a complete service is carried out before long-term storage.
- The transport guard must always be fitted to the cutting attachment when the machine is being transported or in storage.
- In order to prevent unintentional starting of the engine, the spark plug cap must always be removed during long-term storage, if the machine is not under close supervision and when performing all service measures.



WARNING! Take care when handling fuel. Bear in mind the risk of fire, explosion and inhaling fumes.

Fuel

CAUTION! The machine is equipped with a two-stroke engine and must always be run using a mixture of petrol and two-stroke engine oil. It is important to accurately measure the amount of oil to be mixed to ensure that the correct mixture is obtained. When mixing small amounts of fuel, even small inaccuracies can drastically affect the ratio of the mixture.



WARNING! Fuel and fuel fumes are highly inflammable and can cause serious injury when inhaled or allowed to come in contact with the skin. For this reason observe caution when handling fuel and make sure there is adequate ventilation.

Petrol



CAUTION! Always use a quality petrol/oil mixture at least 90 octane (RON). If your machine is equipped with a catalytic converter (see chapter on Technical data) always use a good quality unleaded petrol/oil mixture. Leaded petrol will destroy the catalytic converter.

Use low-emission petrol, also known as alkylate petrol, if it is available.



- The lowest octane recommended is 90 (RON). If you run the engine on a lower octane grade than 90 so-called knocking can occur. This gives rise to a high engine temperature, which can result in serious engine damage.
- When working at continuous high revs a higher octane rating is recommended.

Two-stroke oil

- For best results and performance use HUSQVARNA two-stroke engine oil, which is specially formulated for our air-cooled two-stroke engines.
- Never use two-stroke oil intended for water-cooled engines, sometimes referred to as outboard oil (rated TCW).
- Never use oil intended for four-stroke engines.
- A poor oil quality and/or too high oil/fuel ratio may jeopardise function and decrease the life time of catalytic converters.
- Mixing ratio
 - 1:50 (2%) with HUSQVARNA two-stroke oil.
 - 1:33 (3%) with oils class JASO FB or ISO EGB formulated for air-cooled, two-stroke engines.

Petrol, litre	Two-stroke oil, litre	
	2% (1:50)	3% (1:33)
5	0,10	0,15
10	0,20	0,30
15	0,30	0,45
20	0,40	0,60

FUEL HANDLING

Mixing

- Always mix the petrol and oil in a clean container intended for fuel.
- Always start by filling half the amount of the petrol to be used. Then add the entire amount of oil. Mix (shake) the fuel mixture. Add the remaining amount of petrol.
- Mix (shake) the fuel mixture thoroughly before filling the machine's fuel tank.

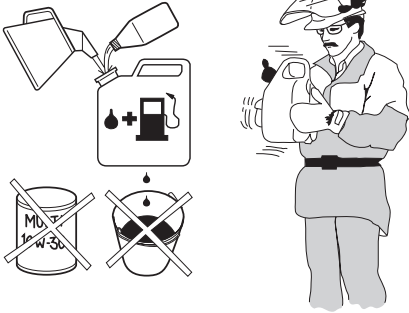

- Do not mix more than one month's supply of fuel at a time.
- If the machine is not used for some time the fuel tank should be emptied and cleaned.



WARNING! The catalytic converter muffler gets very hot during and after use. This also applies during idling. Be aware of the fire hazard, especially when working near flammable substances and/or vapours.

Fuelling



WARNING! Taking the following precautions, will lessen the risk of fire:

Do not smoke or place hot objects near fuel.

Always shut off the engine before refuelling.

Always stop the engine and let it cool for a few minutes before refuelling.

When refuelling, open the fuel cap slowly so that any excess pressure is released gently.

Tighten the fuel cap carefully after refuelling.

Always move the machine away from the refuelling area before starting.

- Always use a fuel container with an anti-spill valve.
- Clean the area around the fuel cap. Contamination in the tank can cause operating problems.
- Ensure that the fuel is well mixed by shaking the container before filling the tank.

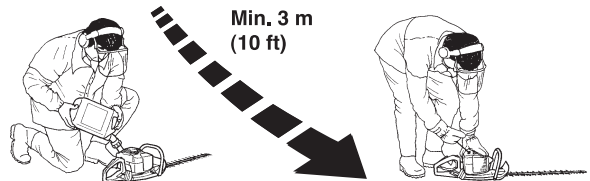

STARTING AND STOPPING

Check before starting



- Inspect the working area. Remove any objects that could be thrown out.
- Check the cutting attachment. Never use blades that are dull, cracked or damaged.

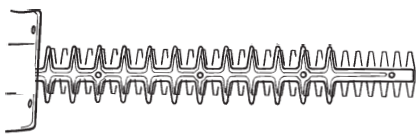

- Check that the machine is in perfect working order. Check that all nuts and screws are tight.
- Make sure the gear housing is lubricated correctly. See instructions under the heading Gear housing.
- Check that the cutting attachment always stops when the engine is idling.
- Only use the machine for the purpose it was intended for.
- Make sure that the handle and safety features are in good working order. Never use a machine that lacks a part or has been modified outside its specifications.
- All covers must be correctly fitted and undamaged before you start the machine.

Starting and stopping



WARNING! The complete clutch cover and gear housing must be fitted before the machine is started, otherwise the clutch may come loose and cause personal injury.

Always move the machine about 3 metres from the refuelling position before starting. Place the machine on a firm surface. Remember that the blades may start to move when the engine is started. Make sure the blades cannot come into contact with any object. Make sure that no unauthorised persons are in the working area, otherwise there is a risk of serious personal injury. The safety distance is 15 metres.

Cold engine

Primer bulb:

Press the air purge repeatedly until fuel begins to fill the bulb. The bulb need not be completely filled.

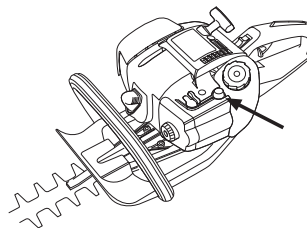

Choke:

Set the choke control in the choke position.

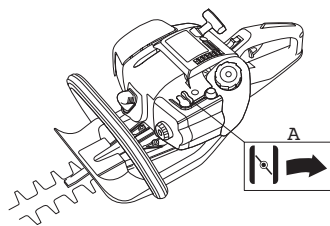

Warm engine

Primer bulb:

Press the air purge repeatedly until fuel begins to fill the bulb. The bulb need not be completely filled.

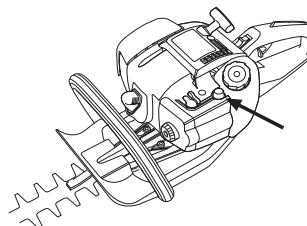

STARTING AND STOPPING

Starting

Hold the body of the machine on the ground using your left hand (CAUTION! Not with your foot!). Grip the starter handle, slowly pull out the cord with your right hand until you feel some resistance (the starter pawls grip), now quickly and powerfully pull the cord.

Push the choke control back to its original position as soon as the engine fires, and continue trying to start until the engine starts.

CAUTION! Do not pull the starter cord all the way out and do not let go of the starter handle when the cord is fully extended. This can damage the machine.



Stopping

The engine is switched off by moving the stop switch to the stop position.

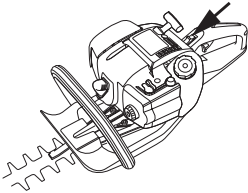

CAUTION! The stop switch automatically returns to the start position. In order to prevent unintentional starting, the spark plug cap must be removed from the spark plug when assembling, checking and/or performing maintenance.

WORKING TECHNIQUES

General working instructions

IMPORTANT!

This section takes up the basic safety precautions for working with a hedge trimmer.

If you encounter a situation where you are uncertain how to proceed you should ask an expert. Contact your dealer or your service workshop.

Avoid all usage which you consider to be beyond your capability.



WARNING! The machine can cause serious personal injury. Read the safety instructions carefully. Learn how to use the machine.



WARNING! Cutting tool. Do not touch the tool without first switching off the engine.

Personal protection

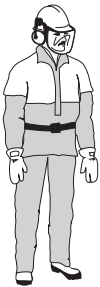

- Wear personal protective equipment. See instructions under the heading Personal protective equipment.
- Always wear working clothes and heavy-duty long trousers.
- Never wear loose clothing or jewellery.
- Make sure your hair does not hang below shoulder level.

Safety instructions regarding the surroundings

- Never allow children to use the machine.
- Ensure that no-one comes closer than 15 m while you are working.
- Never allow anyone else to use the machine without first ensuring that they have understood the contents of the operator's manual.
- Never work from a ladder, stool or any other raised position that is not fully secured.

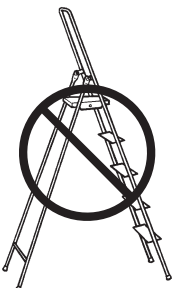

Safety instructions while working



- Always ensure you have a safe and stable working position.
- Always use both hands to hold the machine. Hold the machine in front of your body.

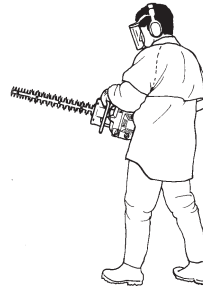

- Make sure that your hands and feet do not come near the cutting attachment when the engine is running.



- When the engine is switched off, keep your hands and feet away from the cutting attachment until it has stopped completely.
- Watch out for stumps of branches that can be thrown out during cutting.
- Do not cut too close to the ground. Stones and other objects can be thrown out.
- Check the working area for foreign objects such as electricity cables, insects and animals, etc, or other objects that could damage the cutting attachment, such as metal items.
- If any foreign object is hit or if vibrations occur stop the machine immediately. Disconnect the HT lead from the spark plug. Check that the machine is not damaged. Repair any damage.
- If anything jams in the blades while you are working, switch off the engine and wait until it has stopped completely before cleaning the blades. Disconnect the HT lead from the spark plug.

WORKING TECHNIQUES

Safety instructions after completing work



- The transport guard should always be fitted to the cutting attachment when the machine is not in use.
- Make sure the cutting attachment has stopped before cleaning, carrying out repairs or an inspection. Disconnect the HT lead from the spark plug.
- Always wear heavy-duty gloves when repairing the cutting attachment. This is extremely sharp and can easily cause cuts.



- Store the machine out of reach of children.
- Use only original spare parts for repairs.

Basic working techniques

- Work with a swinging action from the bottom upwards when trimming sides.
- Adjust the throttle setting to suit the load.
- When trimming a hedge the engine should always face away from the hedge.
- Hold the machine as close to your body as possible to get the best balance.

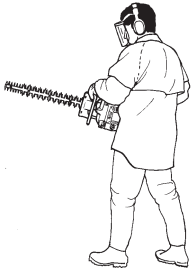

- Make sure that the tip does not touch the ground.
- Do not rush the work, but work steadily until all the branches have been cut back cleanly.

(325HD60, 325HD75)

- The hedge trimmer's rear handle can be set in three positions by pulling out the catch. See figure. When the handle is adjusted the hedge trimmer should be idling or not running.

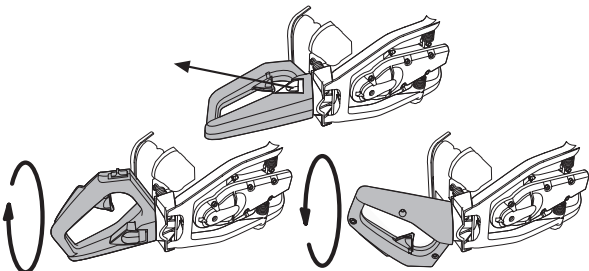

- While working the handle should always be facing upwards irrespective of how the hedge trimmer is directed.

MAINTENANCE

Carburettor

Your Husqvarna product has been designed and manufactured to specifications that reduce harmful emissions. After the engine has used 8-10 tanks of fuel the engine will be run-in. To ensure that it continues to run at peak performance and to minimise harmful exhaust emissions after the running-in period, ask your dealer/service workshop (who will have a rev counter at their disposal) to adjust your carburettor.



WARNING! The complete clutch cover and gear housing must be fitted before the machine is started, otherwise the clutch may come loose and cause personal injury.

Function



- The carburettor governs the engine's speed via the throttle control. Air and fuel are mixed in the carburettor. The air/fuel mixture is adjustable. Correct adjustment is essential to get the best performance from the machine.
- Adjusting the carburettor means that the engine is adapted to local operating conditions, e.g. climate, altitude, petrol and the type of 2-stroke oil.
- The carburettor has three adjustment controls:

L = Low speed jet

H = High speed jet

T = Idle adjustment screw

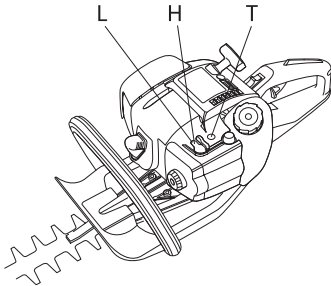

- The L and H-jets are used to adjust the supply of fuel to match the rate that air is admitted, which is controlled with the throttle. If they are screwed clockwise the air/fuel ratio becomes leaner (less fuel) and if they are turned anti-clockwise the ratio becomes richer (more fuel). A lean mixture gives a higher engine speed and a rich mixture gives a lower engine speed.
- The T-screw regulates the throttle setting at idle speed. If the T-screw is turned clockwise this gives a higher idle speed; turning it anti-clockwise gives a lower idle speed.

Basic setting

- The basic carburettor settings are adjusted during testing at the factory. The basic setting is richer than the optimal setting and should be maintained for the first few hours the machine is in use. The carburettor should then be finely adjusted. Fine adjustment should be carried out by a skilled technician.

CAUTION! If the blades move while the engine is idling the T screw should be turned anti-clockwise until they stop.

Rec. idle speed 2700 rpm

Recommended max. speed: See the Technical data section.



WARNING! If the idle speed cannot be adjusted so that the cutting attachment stops, contact your dealer/service workshop. Do not use the machine until it has been correctly adjusted or repaired.

Fine adjustment

- When the machine has been "run-in" the carburettor should be finely adjusted. The fine adjustment should be carried out by a qualified person. First adjust the L-jet, then the idling screw T and then the H-jet.

Conditions

- Before any adjustments are made, make sure that the air filter is clean and the air filter cover is fitted. If you adjust the carburettor when the air filter is dirty it will result in a leaner mixture when the filter is finally cleaned. This can lead to serious engine damage.
- Carefully turn both jets, L and H, so that they are midway between fully screwed in and fully screwed out.
- Do not attempt to adjust the L and H jets beyond either stop as this could cause damage.
- Now start the machine according to the starting instructions and let it warm up for 10 minutes.

CAUTION! If the blades move while the engine is idling the T screw should be turned anti-clockwise until they stop.

Low speed jet L

Try to find the highest idle speed by turning the low speed jet L clockwise then anti-clockwise. When the highest speed has been found, turn the low speed jet L 1/4 turn anti-clockwise.

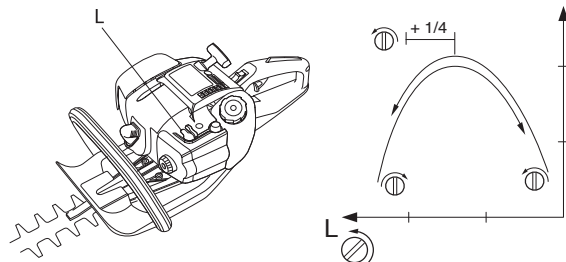

CAUTION! If the blades move while the engine is idling the T screw should be turned anti-clockwise until they stop.

MAINTENANCE

Fine adjustment of the idle speed T

Adjust the idle speed with the idle adjustment screw T, if adjustment is necessary. First turn the idle adjustment screw T clockwise until the blades start to move. Then turn the idle adjustment screw T anticlockwise until the blades stop. The idle speed is correctly adjusted when the engine runs smoothly in every position. There should also be a clear margin to the speed at which the blades start to move.

The blades must also remain stationary when the choke control is in the start throttle position.

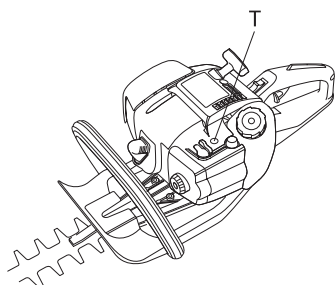

IMPORTANT! If the idle speed cannot be adjusted so that the cutting attachment stops, contact your dealer/service workshop. Do not use the machine until it has been correctly adjusted or repaired.

High speed jet H

The high speed jet H affects the engine power, speed, temperature and fuel consumption. If the high speed jet H is set too lean (screwed in too far) the engine speed will be too high and cause engine damage. Do not let the engine run at full speed for more than 10 seconds.

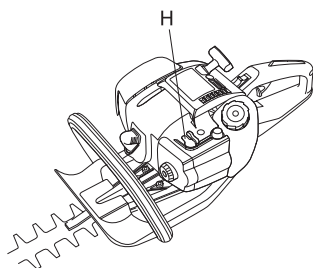

Apply full throttle and turn the high speed jet H very slowly clockwise until the engine slows down. Then turn the high speed jet H very slowly anticlockwise until the engine starts to run unevenly. Now turn the high speed jet H slowly clockwise a little way until the engine runs smoothly.

Note that the engine should not be under load when you adjust the high speed jet H. The high speed jet H is adjusted correctly when the machine burbles a little. If the machine races then the setting is too lean. If the engine produces a lot of smoke and burbles a lot then the setting is too rich.

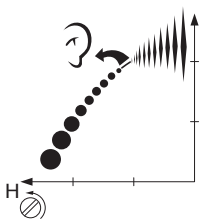

CAUTION! For optimum adjustment of the carburettor, contact a qualified dealer/service workshop that has a revolution counter at their disposal.

Correctly adjusted carburettor

When the carburettor is correctly adjusted the machine accelerates without hesitation and burbles a little at maximum speed. It is also important that the blades do not move when the engine is idling or when the choke control is in the start position. If the low speed jet L is set too lean it may cause starting difficulties and poor acceleration.

If the high speed jet H is set too lean it will result in less power, less performance, poor acceleration and/or damage to the engine. If both the L and H jets are set too rich it will result in acceleration problems or too low a working speed.

Muffler

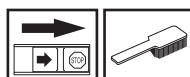

CAUTION! Some mufflers are fitted with a catalytic converter. See chapter on Technical data to see whether your machine is fitted with a catalytic converter.

The muffler is designed to reduce the noise level and to direct the exhaust gases away from the operator. The exhaust gases are hot and can contain sparks, which may cause fire if directed against dry and combustible material.

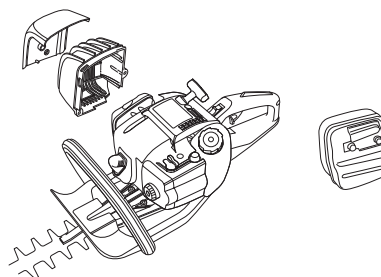

Some mufflers are equipped with a special spark arrester mesh. If your machine has this type of muffler, you should clean the mesh at least once a week. This is best done with a wire brush.

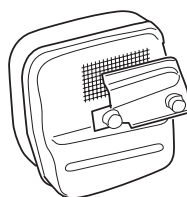

On mufflers without a catalytic converter the mesh should be cleaned weekly, or replaced if necessary. On mufflers fitted with a catalytic converter the mesh should be checked, and if necessary cleaned, monthly. **If the mesh is damaged it should be replaced.** If the mesh is frequently blocked, this can be a sign that the performance of the catalytic converter is impaired. Contact your dealer to inspect the muffler. A blocked mesh will cause the machine to overheat and result in damage to the cylinder and piston. See also instructions under the heading Maintenance.

CAUTION! Never use a machine with a defective muffler.



WARNING! Mufflers fitted with catalytic converters get very hot during use and remain so for some time after stopping. This also applies at idle speed. Contact can result in burns to the skin. Remember the risk of fire!

MAINTENANCE

Cooling system

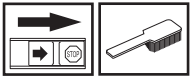

To keep the working temperature as low as possible the machine is equipped with a cooling system.

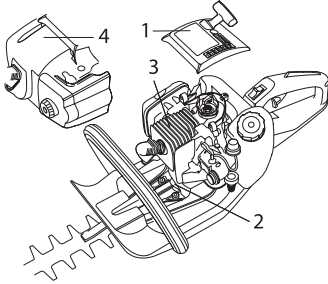

The cooling system consists of:

- 1 Air intake on the starter.
- 2 Fins on the flywheel.
- 3 Cooling fins on the cylinder.
- 4 Cylinder cover (directs cold air over the cylinder).

Clean the cooling system with a brush once a week, more often in demanding conditions. A dirty or blocked cooling system results in the machine overheating which causes damage to the piston and cylinder.

Spark plug



The spark plug condition is influenced by:

- Incorrect carburettor adjustment.
- An incorrect fuel mixture (too much or incorrect type of oil).
- A dirty air filter.

These factors cause deposits on the spark plug electrodes, which may result in operating problems and starting difficulties.

If the machine is low on power, difficult to start or runs poorly at idle speed: always check the spark plug first before taking any further action. If the spark plug is dirty, clean it and check that the electrode gap is 0.5 mm. The spark plug should be replaced after about a month in operation or earlier if necessary.

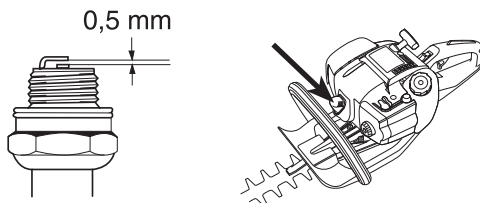

CAUTION! Always use the recommended spark plug type! Use of the wrong spark plug can damage the piston/cylinder. Check that the spark plug is fitted with a suppressor.

Air filter

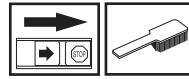

The air filter must be regularly cleaned to remove dust and dirt in order to avoid:

- Carburettor malfunctions
- Starting problems
- Loss of engine power
- Unnecessary wear to engine parts.
- Excessive fuel consumption.

Clean the filter every 25 hours, or more regularly if conditions are exceptionally dusty.

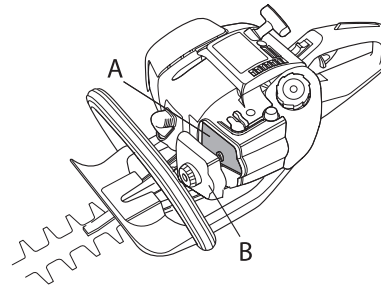

Cleaning the air filter

Remove the air filter cover and take out the filter. Wash it clean in warm, soapy water. Ensure that the filter is dry before refitting it.

An air filter that has been in use for a long time cannot be cleaned completely. The filter must therefore be replaced with a new one at regular intervals. **A damaged air filter must always be replaced.**

If the machine is used in dusty conditions the air filter should be soaked in oil. See instructions under the heading Oiling the air filter.

Oiling the air filter



Always use HUSQVARNA filter oil, art. no. 531 00 92-48. The filter oil contains a solvent to make it spread evenly through the filter. You should therefore avoid skin contact.

Put the filter in a plastic bag and pour the filter oil over it. Knead the plastic bag to distribute the oil. Squeeze the excess oil out of the filter inside the plastic bag and pour off the excess before fitting the filter to the machine. Never use common engine oil. This would drain through the filter quite quickly and collect in the bottom.

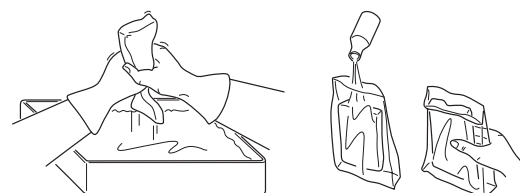

MAINTENANCE

Gear housing



There is a grease nipple and a plug for filling lubricant on the gear housing. Use a grease gun to fill with grease. This should be done after every 60 working hours. Use Husqvarna's special grease, no. 503 98 96-01.

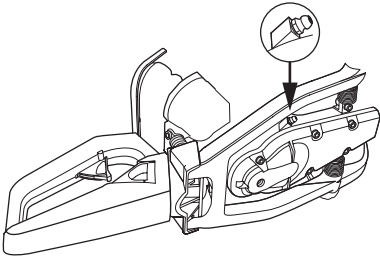

CAUTION! The gear housing must not be filled completely with grease. The grease expands as the machine heats up during operation. If the gear housing was completely filled with grease it could damage the seals and lead to leakage of grease.

The grease in the bevel gear does not normally need to be changed except if repairs are carried out.

Cleaning and lubrication



Clean any resin and plant residue from the blades using cleaning agent 531 00 75-13 (UL22) before and after using the machine.

Lubricate the blade bars with special grease, part no. 531 00 75-12 (UL 21) before long periods of storage.

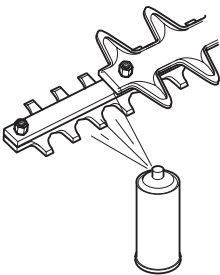

MAINTENANCE

Maintenance schedule

The following is a list of the maintenance that must be performed on the machine. Most of the items are described in the Maintenance section. The user must only carry out the maintenance and service work described in this Operator's Manual. More extensive work must be carried out by an authorised service workshop.

Maintenance	Daily maintenance	Weekly maintenance	Monthly maintenance
Clean the outside of the machine.	X		
Make sure the throttle trigger lock and the throttle function correctly from a safety point of view.	X		
Check that the stop switch works correctly.	X		
Check that the blades do not move when the engine is idling or when the choke is in the start throttle position.	X		
Check that the blades are undamaged and show no signs of cracking or other damage. Replace the blades if necessary.	X		
Check that the blade guard is not damaged or distorted. Replace the blade guard if it is bent or damaged.	X		
Clean the air filter. Replace if necessary.	X		
Check that the hand guard is not damaged. Replace the guard if damaged.	X		
Check that nuts and screws are tight.	X		
Check that there are no fuel leaks from the engine, tank or fuel lines.	X		
Check the starter and starter cord.		X	
Check that the vibration damping elements are not damaged.		X	
Clean the outside of the spark plug. Remove it and check the electrode gap. Adjust the gap to 0.5 mm or replace the spark plug. Check that the spark plug is fitted with a suppressor.		X	
Clean the machines cooling system.		X	
Clean or replace the spark arrestor mesh on the muffler (only applies to mufflers without a catalytic converter).		X	
Clean the outside of the carburettor and the space around it.		X	
Fill the gear housing with grease. This should be carried out approximately every 60 working hours.		X	
Check that the screws that hold the blades together are correctly tightened.		X	
Clean the fuel tank.			X
Check the fuel filter from contamination and the fuel hose from cracks or other defects. Replace if necessary.			X
Check all cables and connections.			X
Check the clutch, clutch springs and the clutch drum for wear. Replace if necessary by an authorized service workshop.			X
Replace the spark plug. Check that the spark plug is fitted with a suppressor.			X
Check and clean the spark arrestor mesh on the muffler (only applies to mufflers fitted with a catalytic converter).			X
Clean dirt, leaves and surplus lubricant, etc from the muffler and engine.			X

TECHNICAL DATA

Technical data

Technical data	323HD60	325HD60	325HD75
Engine			
Cylinder displacement, cm ³	24,5	24,5	24,5
Cylinder bore, mm	34,0	34,0	34,0
Stroke, mm	27	27	27
Idle speed, rpm	2700	2700	2700
Recommended max. speed, rpm	11000-12600	11000-12600	11000-12600
Max. engine output, acc. to ISO 8893	0,7/9000	0,7/9000	0,7/9000
Catalytic converter muffler	Yes	Yes	Yes
Speed-regulated ignition system	Yes	Yes	Yes
Ignition system			
Manufacturer/type of ignition system	Walbro MB	Walbro MB	Walbro MB
Spark plug	Champion RCJ 7Y	Champion RCJ 7Y	Champion RCJ 7Y
Electrode gap, mm	0,5	0,5	0,5
Fuel and lubrication system			
Manufacturer/type of carburettor	Zama C1Q	Zama C1Q	Zama C1Q
Fuel tank capacity, litre	0,40	0,40	0,40
Weight			
Weight without fuel, kg	5,6	5,6	5,9
Noise emissions			
(see note 1)			
Sound power level, measured dB(A)	109	109	109
Sound power level, guaranteed L _{WA} dB(A)	109	109	109
Sound levels			
(see note 2)			
Equivalent noise pressure level at the operator's ear, measured according to EN/ISO 11806 and ISO 7917, dB(A), min./max.:	100	100	99
Vibration levels			
Vibration levels at handles, measured according to EN/ISO 11806 and ISO 7916, m/s ²			
Idle speed, rear/front handles:	2,0/2,0	1,5/2,3	2,3/3,5
Max. speed, rear/front handles:	4,1/5,6	5,5/6,0	3,9/2,5
Blades			
Type	Double sided	Double sided	Double sided
Length, mm	600	600	735
Blade speed, cuts/min	4695	4695	4695

Note 1: Noise emissions in the environment measured as sound power (L_{WA}) in conformity with EC directive 2000/14/EC.

Note 2: Equivalent sound pressure level is calculated as the time-weighted energy total for sound pressure levels under various working conditions with the following time distribution: 1/2 idling and 1/2 max speed.

TECHNICAL DATA

EC-declaration of conformity (Applies to Europe only)

Husqvarna AB, SE-561 82 Huskvarna, Sweden, tel: +46-36-146500, declare under sole responsibility that the hedge trimmers **Husqvarna 323HD60, 325HD60 and 325HD75** from 2002's serial numbers and onwards (the year is clearly stated in plain text on the type plate with subsequent serial number), are in conformity with the standards or other normative documents following the provisions in the COUNCIL'S DIRECTIVES:

of June 22, 1998 "relating to machinery" **98/37/EC**, annex IIA.

of May 3, 1989 "relating to electromagnetic compatibility" **89/336/EEC**, and applicable supplements.

of May 8, 2000 "relating to the noise emissions in the environment" **2000/14/EC**.

For information relating to noise emissions, see the chapter Technical data. The following standards have been applied: **EN292-2, CISPR 12:1997, EN774**

SMP Svensk Maskinprovning AB, Fyrisborgsgatan 3, SE-754 50 Uppsala, Sweden, has carried out voluntary type approval for Husqvarna AB. The certificates have the numbers: SEC/02/881, 01/094/007 - 323HD60, SEC/02/853, 01/094/005 - 325HD60, SEC/02/853, 01/094/005 - 325HD75

Huskvarna January 3, 2002



Bo Andréasson, Development manager



1150087-26



2005-05-31