

OWNER'S MANUAL
Model Number H346SG
Product No. 960 73 00-06
46 Inch Mower
Grass Catcher

- **Assembly**
- **Operation**
- **Customer Responsibilities**
- **Repair Parts**

 **Husqvarna**



SAFETY RULES



Safe Operation Practices for Ride-On Mowers

IMPORTANT: THIS CUTTING MACHINE IS CAPABLE OF AMPUTATING HANDS AND FEET AND THROWING OBJECTS. FAILURE TO OBSERVE THE FOLLOWING SAFETY INSTRUCTIONS COULD RESULT IN SERIOUS INJURY OR DEATH.



WARNING: In order to prevent accidental starting when setting up, transporting, adjusting or making repairs, always disconnect spark plug wire and place wire where it cannot contact spark plug.



WARNING: Do not coast down a hill in neutral, you may lose control of the tractor.



WARNING: Tow only the attachments that are recommended by and comply with specifications of the manufacturer of your tractor. Use common sense when towing. Operate only at the lowest possible speed when on a slope. Too heavy of a load, while on a slope, is dangerous. Tires can lose traction with the ground and cause you to lose control of your tractor.

I. GENERAL OPERATION

- Read, understand, and follow all instructions on the machine and in the manual before starting.
- Do not put hands or feet near rotating parts or under the machine. Keep clear of the discharge opening at all times.
- Only allow responsible adults, who are familiar with the instructions, to operate the machine.
- Clear the area of objects such as rocks, toys, wire, etc., which could be picked up and thrown by the blades.
- Be sure the area is clear of bystanders before operating. Stop machine if anyone enters the area.
- Never carry passengers.
- Do not mow in reverse unless absolutely necessary. Always look down and behind before and while backing.
- Never direct discharged material toward anyone. Avoid discharging material against a wall or obstruction. Material may ricochet back toward the operator. Stop the blades when crossing gravel surfaces.
- Do not operate machine without the entire grass catcher, discharge guard, or other safety devices in place and working.
- Slow down before turning.
- Never leave a running machine unattended. Always turn off blades, set parking brake, stop engine, and remove keys before dismounting.
- Disengage blades when not mowing. Shut off engine and wait for all parts to come to a complete stop before cleaning the machine, removing the grass catcher, or unclogging the discharge guard.
- Operate machine only in daylight or good artificial light.
- Do not operate the machine while under the influence of alcohol or drugs.
- Watch for traffic when operating near or crossing roadways.
- Use extra care when loading or unloading the machine into a trailer or truck.
- Always wear eye protection when operating machine.

- Data indicates that operators, age 60 years and above, are involved in a large percentage of riding mower-related injuries. These operators should evaluate their ability to operate the riding mower safely enough to protect themselves and others from serious injury.
- Follow the manufacturer's recommendation for wheel weights or counterweights.
- Keep machine free of grass, leaves or other debris build-up which can touch hot exhaust/engine parts and burn. Do not allow the mower deck to plow leaves or other debris which can cause build-up to occur. Clean any oil or fuel spillage before operating or storing the machine. Allow machine to cool before storage.

II. SLOPE OPERATION

Slopes are a major factor related to loss of control and tip-over accidents, which can result in severe injury or death. Operation on all slopes requires extra caution. If you cannot back up the slope or if you feel uneasy on it, do not mow it.

- Mow up and down slopes, not across.
- Watch for holes, ruts, bumps, rocks, or other hidden objects. Uneven terrain could overturn the machine. Tall grass can hide obstacles.
- Choose a low ground speed so that you will not have to stop or shift while on the slope.
- Do not mow on wet grass. Tires may lose traction. Always keep the machine in gear when going down slopes. Do not shift to neutral and coast downhill.
- Avoid starting, stopping, or turning on a slope. If the tires lose traction, disengage the blades and proceed slowly straight down the slope.
- Keep all movement on the slopes slow and gradual. Do not make sudden changes in speed or direction, which could cause the machine to roll over.
- Use extra care while operating machine with grass catchers or other attachments; they can affect the stability of the machine. Do no use on steep slopes.
- Do not try to stabilize the machine by putting your foot on the ground.
- Do not mow near drop-offs, ditches, or embankments. The machine could suddenly roll over if a wheel is over the edge or if the edge caves in.

III. CHILDREN

Tragic accidents can occur if the operator is not alert to the presence of children. Children are often attracted to the machine and the mowing activity. *Never* assume that children will remain where you last saw them.

- Keep children out of the mowing area and in the watchful care of a responsible adult other than the operator.
- Be alert and turn machine off if a child enters the area.
- Before and while backing, look behind and down for small children.
- Never carry children, even with the blades shut off. They may fall off and be seriously injured or interfere with safe machine operation. Children who have been given rides in the past may suddenly appear in the mowing area for another ride and be run over or backed over by the machine.
- Never allow children to operate the machine.
- Use extra care when approaching blind corners, shrubs, trees, or other objects that may block your view of a child.



SAFETY RULES



Safe Operation Practices for Ride-On Mowers

IV. TOWING

- Tow only with a machine that has a hitch designed for towing. Do not attach towed equipment except at the hitch point.
- Follow the manufacturer's recommendation for weight limits for towed equipment and towing on slopes.
- Never allow children or others in or on towed equipment.
- On slopes, the weight of the towed equipment may cause loss of traction and loss of control.
- Travel slowly and allow extra distance to stop.

V. SERVICE

SAFE HANDLING OF GASOLINE

To avoid personal injury or property damage, use extreme care in handling gasoline. Gasoline is extremely flammable and the vapors are explosive.

- Extinguish all cigarettes, cigars, pipes, and other sources of ignition.
- Use only approved gasoline container.
- Never remove gas cap or add fuel with the engine running. Allow engine to cool before refueling.
- Never fuel the machine indoors.
- Never store the machine or fuel container where there is an open flame, spark, or pilot light such as on a water heater or other appliances.
- Never fill containers inside a vehicle or on a truck or trailer bed with plastic liner. Always place containers on the ground away from your vehicle when filling.
- Remove gas-powered equipment from the truck or trailer and refuel it on the ground. If this is not possible, then refuel such equipment with a portable container, rather than from a gasoline dispenser nozzle.
- Keep the nozzle in contact with the rim of the fuel tank or container opening at all times until fueling is complete. Do not use a nozzle lock-open device.
- If fuel is spilled on clothing, change clothing immediately.
- Never overfill fuel tank. Replace gas cap and tighten securely.

GENERAL SERVICE

- Never operate machine in a closed are.
- Keep all nuts and bolts tight to be sure the equipment is in safe working condition.
- Never tamper with safety devices. Check their proper operation regularly.
- Keep machine free of grass, leaves, or other debris build-up. Clean oil or fuel spillage and remove any fuel-soaked debris. Allow machine to cool before storing.
- If you strike a foreign object, stop and inspect the

- machine. Repair, if necessary, before restarting.
- Never make any adjustments or repairs with the engine running.
- Check grass catcher components and the discharge guard frequently and replace with manufacturer's recommended parts, when necessary.
- Mower blades are sharp. Wrap the blade or wear gloves, and use extra caution when servicing them.
- Check brake operation frequently. Adjust and service as required.
- Maintain or replace safety and instruction labels, as necessary.



- Be sure the area is clear of bystanders before operating. Stop machine if anyone enters the area.
- Never carry passengers.
- Do not mow in reverse unless absolutely necessary. Always look down and behind before and while backing.
- Never carry children, even with the blades shut off. They may fall off and be seriously injured or interfere with safe machine operation. Children who have been given rides in the past may suddenly appear in the mowing area for another ride and be run over or backed over by the machine.
- Keep children out of the mowing area and in the watchful care of a responsible adult other than the operator.
- Be alert and turn machine off if a child enters the area.
- Before and while backing, look behind and down for small children.
- Mow up and down slopes (15° Max), not across.
- Be alert and turn machine off if a child enters the area.
- Choose a low ground speed so that you will not have to stop or shift while on the slope.
- Avoid starting, stopping, or turning on a slope. If the tires lose traction, disengage the blades and proceed slowly straight down the slope.
- If machine stops while going uphill, disengage blades, shift into reverse and back down slowly.
- Do not turn on slopes unless necessary, and then, turn slowly and gradually downhill, if possible.

CONGRATULATIONS on your purchase of a new Grass Catcher. It has been designed, engineered and manufactured to give you the best possible dependability and performance.

Should you experience any problems you cannot easily remedy, please contact your nearest authorized service center/department. They have competent, well trained technicians and the proper tools to service or repair this unit.

Please read and retain this manual. The instructions will enable you to assemble and maintain your Grass Catcher properly. Always observe the "SAFETY RULES".

TABLE OF CONTENTS

SAFETY RULES	2-3	CUSTOMER RESPONSIBILITIES.....	9
ASSEMBLY	5-8	STORAGE.....	9
OPERATION	8	REPAIR PARTS	Center of Manual

KNOW YOUR GRASS CATCHER

READ THIS OWNER'S MANUAL AND SAFETY RULES BEFORE ASSEMBLING OR OPERATING YOUR GRASS CATCHER. Compare the illustrations with the carton contents to familiarize yourself with the parts before starting the assembly. Study the operating instructions and safety precautions thoroughly to insure proper functioning of your Grass Catcher and to prevent injury to yourself and others. Save this manual for future reference.



The operation of any tractor can result in foreign objects thrown into the eyes, which can result in severe eye damage. Always wear safety glasses or eye shields before starting your tractor and while mowing. We recommend a wide vision safety mask for over the spectacles or standard safety glasses.

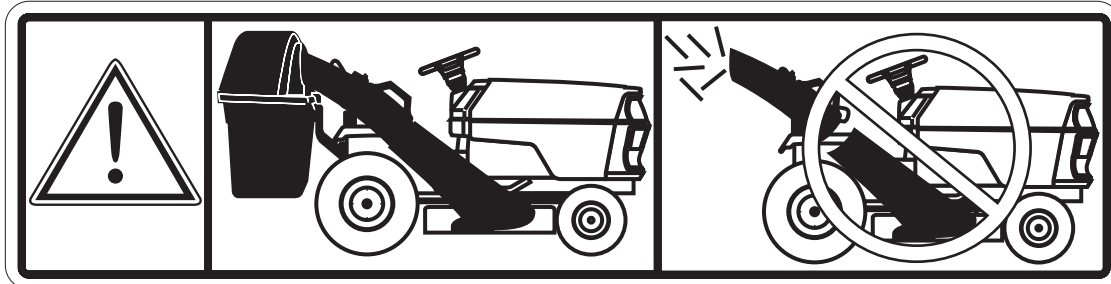

COMPLETE BAGGER MUST BE IN PLACE BEFORE OPERATING MOWER

UNPACKING INSTRUCTIONS

- Remove all parts and packing materials from carton.
- Check carton contents against list. Be sure all parts are there.

CARTON CONTENTS:

- | | |
|-----------------|----------------------|
| (3) Containers | (1) Support Assembly |
| (1) Upper Chute | (1) Cover Assembly |
| (1) Lower Chute | (1) Retainer Spring |

PARTS IDENTIFICATION

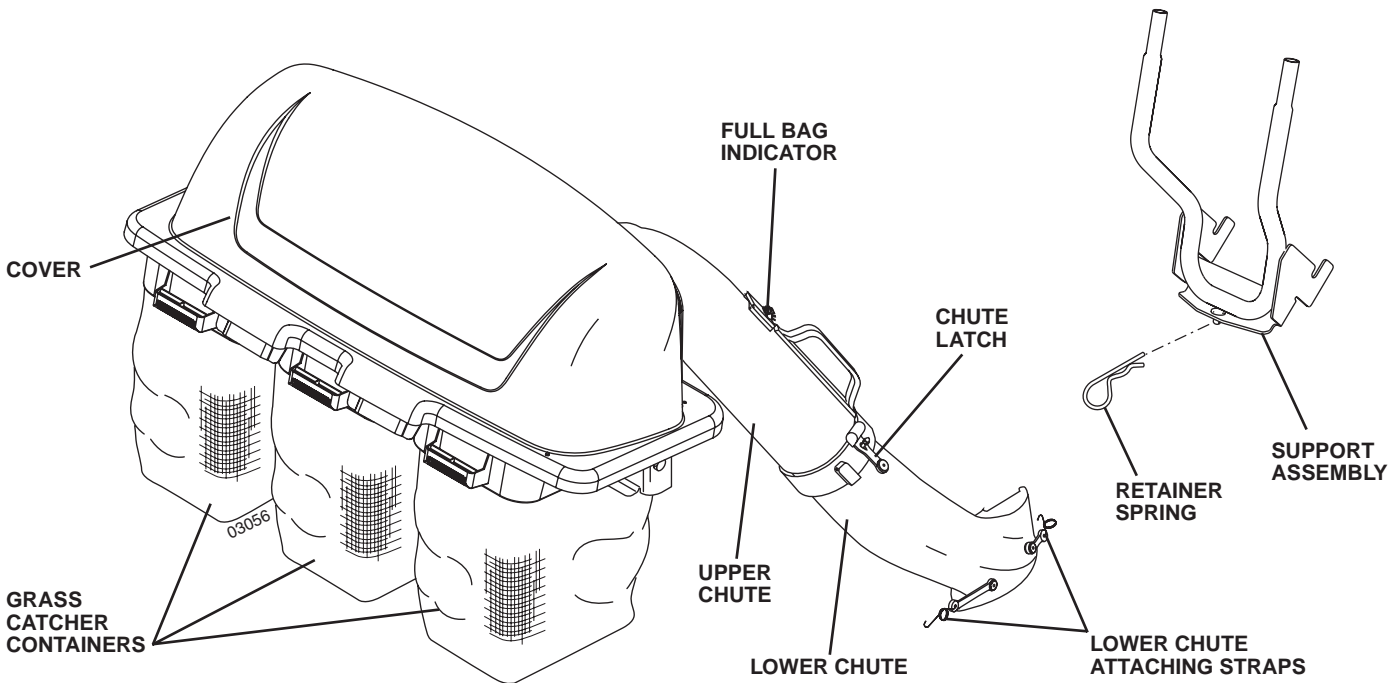

NOTE: When right hand (R.H.) and left hand (L.H.) are mentioned in this manual, it means when you are seated on the tractor, in the operator's position.

CAUTION: BEFORE ASSEMBLING GRASS CATCHER TO TRACTOR:



- Depress clutch/brake pedal fully and set parking brake.
- Place gearshift/motion control lever in "NEUTRAL" position.
- Place attachment clutch in "DISENGAGED" position.
- Turn ignition key "OFF" and remove key.
- Make sure the blade and all moving parts have completely stopped.
- Disconnect spark plug wire from plug and place where it cannot come in contact with plug.

ASSEMBLY

1 HANG SUPPORT ASSEMBLY ON REAR DRAWBAR (See Fig. 1)

1. Slide flanges of support assembly into drawbar slots first, then, pivot backwards inserting pin into drawbar pin hole.
2. **Be sure support assembly is seated properly, then secure with retainer spring.**

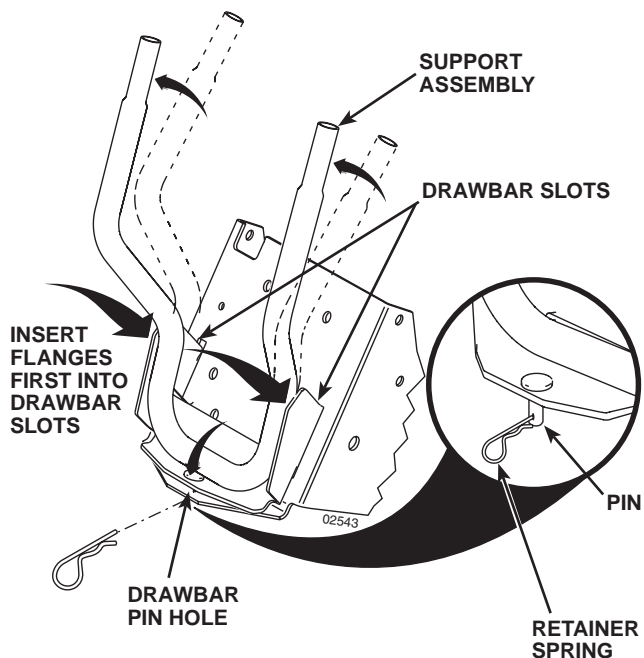
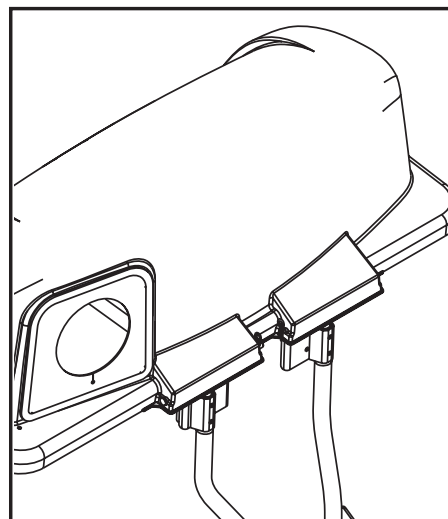
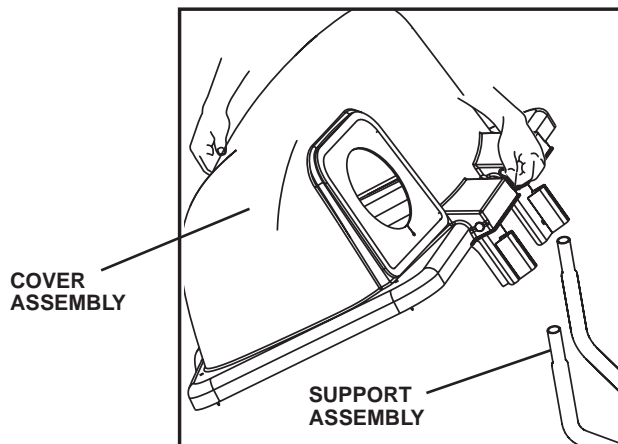

FIG. 1

2 MOUNTING COVER ASSEMBLY TO SUPPORT ASSEMBLY (See Fig. 2)

NOTE: For ease of assembly, you may wish to obtain the assistance of another person for mounting cover assembly to tractor.

1. Position cover assembly on ground behind tractor.
2. Lift and rotate cover to align cover brackets with support assembly tubes.
3. Slide cover assembly down onto the support tubes.



03024

FIG. 2

3 CONTAINER MOUNTING (See Fig. 3)

1. Install one container to left side first. Install another container to center position and one in right position.

NOTE: Left edge of right container should always overlap right edge of left container at center supports.

2. Close cover and lock latches over center support tubes. To lock and release latches, pull back on latch handles.

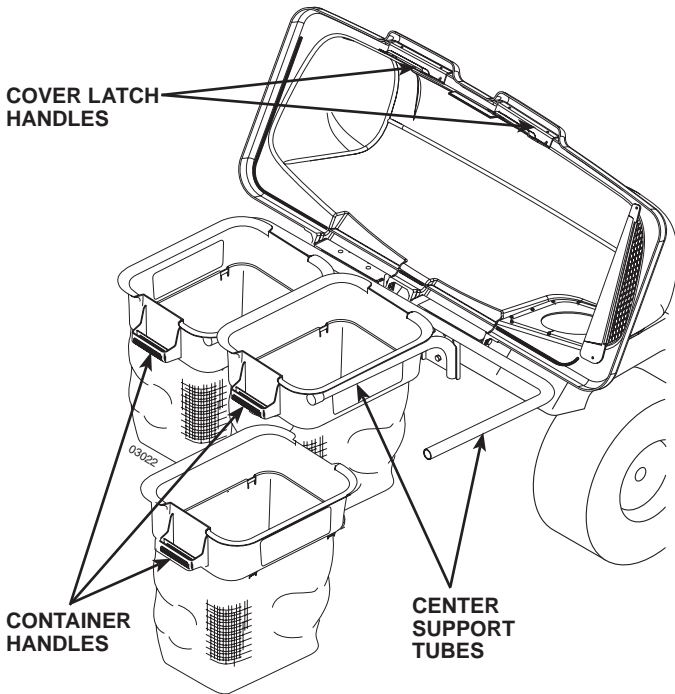

FIG. 3

4 LOWER CHUTE (See Fig. 4)

1. Raise and hold deflector shield in upright position.
2. Place slot in lower chute over mounting tab on mower and position lower chute over mower opening as shown.
3. Hook rear latch into flange hole on back of mower.
4. Hook front latch into hole in front gauge wheel bracket or under gauge wheel bracket on mower without a hole in the bracket.



CAUTION: Do not remove deflector shield from mower. Raise and hold shield when attaching lower chute and allow it to rest on chute while in operation.

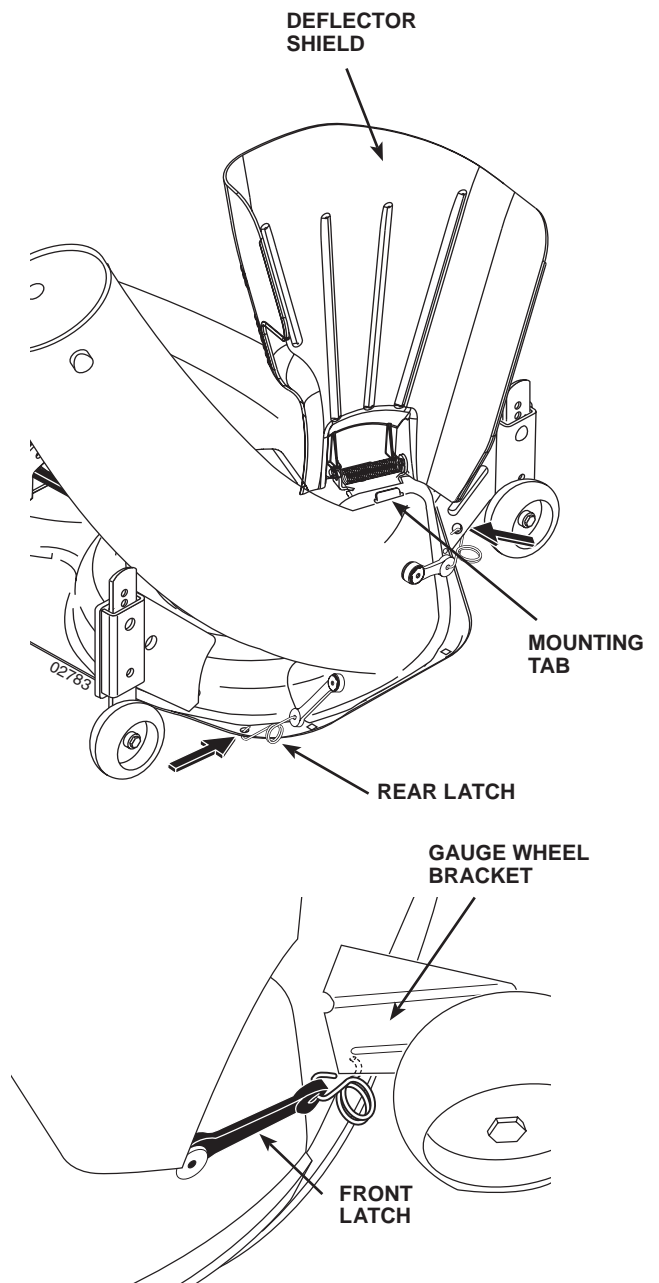

FIG. 4

5 UPPER CHUTE (See Figs. 5A and 5B)

1. Lower mower to its lowest cutting position.
2. Assemble upper chute by inserting curved end into hole in back of cover.

TIP: Holding upper chute as shown and twisting while installing in cover will help keep the rubber seal in place.

NOTE: Handle carefully so as not to damage full bag indicator.

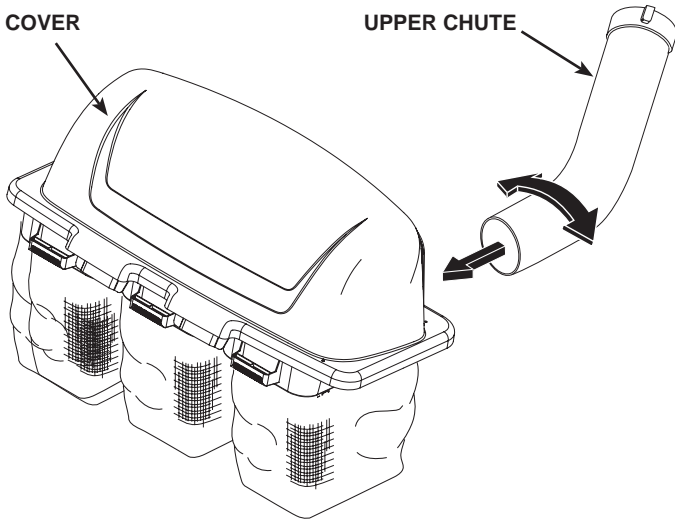

FIG. 5A

3. Push in and turn upper chute until it is in line with lower chute.
4. Align the bosses on lower chute with alignment slots on upper chute and slide together.
5. Secure with rubber latch by hooking hole in latch over latch pin.

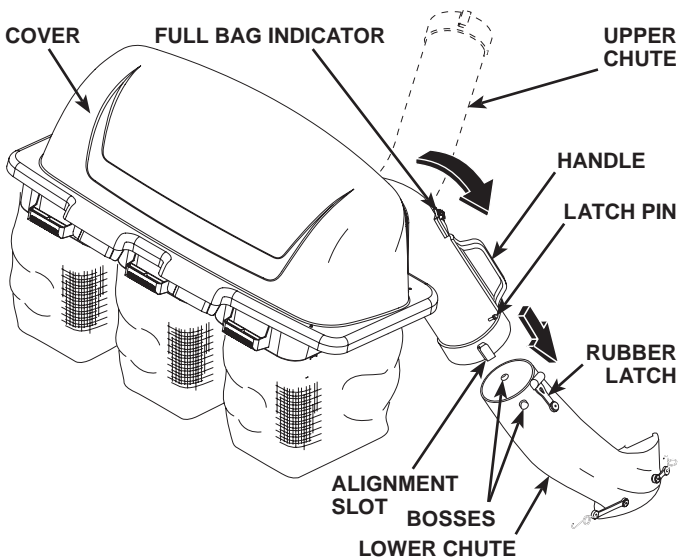

FIG. 5B

6 LEVEL MOWER DECK

Be sure deck is properly leveled for best mower performance. See your tractor's owner's manual for instructions.

OPERATION

TIPS FOR IMPROVED BAGGING OPERATION:

Follow the mower operation instructions in your tractor owner's manual.

When operating your grass catcher on a lawn where grass and leaf bagging equipment has not been used, you are picking up thatch and debris that has accumulated for long periods of time. The amount collected and the total time of operation may be greater than you will experience with regular use of your grass catcher.

- Always run throttle at full speed when bagging.
- Select a gear low enough to give good mower cutting performance, good quality cut and good bagging performance.

NOTE: It may be necessary to overlap width of cut to suit your conditions.

- If grass is extremely tall, it should be mowed twice. The first time relatively high, the second time to desired height.
- Use left hand side of mower for trimming.
- Plastic trash bags can be inserted inside grass catcher containers for ease of debris disposal. To remove the plastic trash bags when full:
 - a. Disengage blades, shift into neutral, engage the parking brake and stop the engine.
 - b. Raise seat. Unlatch and raise cover.
 - c. Remove one container at a time by grasping container handles and pulling toward the rear, off of the tube rails.
 - d. With the container resting on the ground, close and secure the top of the plastic lawn bag.
 - e. Tip the container on its side and slide the filled bag from the container.
 - f. Install a new plastic lawn bag with the edges of the bag draped over upper lip of the container.
 - g. Repeat for other containers.
 - h. Reinstall containers making sure right container overlaps left container at center supports.
 - j. Close cover and secure latches over center support tubes.
- Avoid cutting wet grass or in the morning while the dew is still heavy. Grass clippings collected under these conditions tend to be sticky and adhere to the walls of the flow path causing clogging.

- Your bagger is equipped with a full bagger indicator. Movement of the wheel increases as the bags fill. The wheel will be spinning fastest just before the bags fill completely. When the wheel stops, it indicates that the bags are full and the chutes have become clogged.

NOTE: To help prevent clogging of chutes, check/empty bags when the wheel is spinning fast. Experience will teach you the best time to empty the bags.

Care should be taken not to damage the parts and that the wheel spins freely at the beginning of each use.

- If the grass catcher fails to pick up cut grass or leaves, it is an indication that clogging has occurred in the system or that the grass catcher containers are full. Usually this is indicated by the stopped movement of the full bagger indicator.
 - a. Disengage blades, shift into neutral, engage the parking brake and stop the engine.
 - Raise seat. Unlatch and raise cover.
 - Slide out containers and dispose of clippings .
 - Replace containers, close cover, and latch.
 - b. Unlatch chutes and check for clogging.
 - Remove all debris in chutes.
 - Reassemble and latch chutes
 - c. Check to insure full bagger indicator has not become clogged.
 - The air passage hole must be clear of debris. Gently insert a small twig or wire into passageway to clear.



CAUTION

- Do not operate mower with grass catcher partially installed.
- Disengage blades and stop engine before leaving tractor seat to empty containers, unclogging chutes, etc.
- Close cover before starting.
- Disengage mower when crossing driveways or gravel surfaces and other areas where thrown objects could be a hazard.
- Do not attempt to vacuum up cans or other potentially hazardous projectiles.

CUSTOMER RESPONSIBILITIES

GENERAL RECOMMENDATIONS

Always observe safety rules when performing any maintenance.

- Before each use check for loose fasteners.
- Clean unit thoroughly after each use.

BLADE CARE

For best results mower blades must be kept sharp. Replace bent or damaged blades.

- See BLADE CARE instructions in your tractor owner's manual.



CAUTION: BEFORE PERFORMING ANY MAINTENANCE, SERVICE OR ADJUSTMENTS:

- Depress clutch brake pedal fully and set parking brake.
- Place gearshift/motion control lever in "NEUTRAL" position.
- Place clutch control in "DISENGAGED" position.
- Turn ignition key to "OFF" position.
- Make sure blades and all moving parts have completely stopped.
- Disconnect spark plug wire(s) from spark plug(s) and place wire where it cannot come in contact with plug.



CAUTION: Grass catcher components are subject to wear, damage and deterioration, which could expose moving parts or allow objects to be thrown. Frequently check components and replace with manufacturer's recommended parts, when necessary.

STORAGE

When grass catcher is to be stored for a period of time, clean it thoroughly, remove all dirt, grass, leaves, etc. Store in a clean, dry place.



CAUTION: Do not leave grass in bagger containers. Empty containers after each use and before storing. Failure to do so may result in spontaneous combustion which could develop into a fire.

REPAIR PARTS

GRASS CATCHER - MODEL NUMBER H346SG (PRODUCT NO. 960 73 00-06)

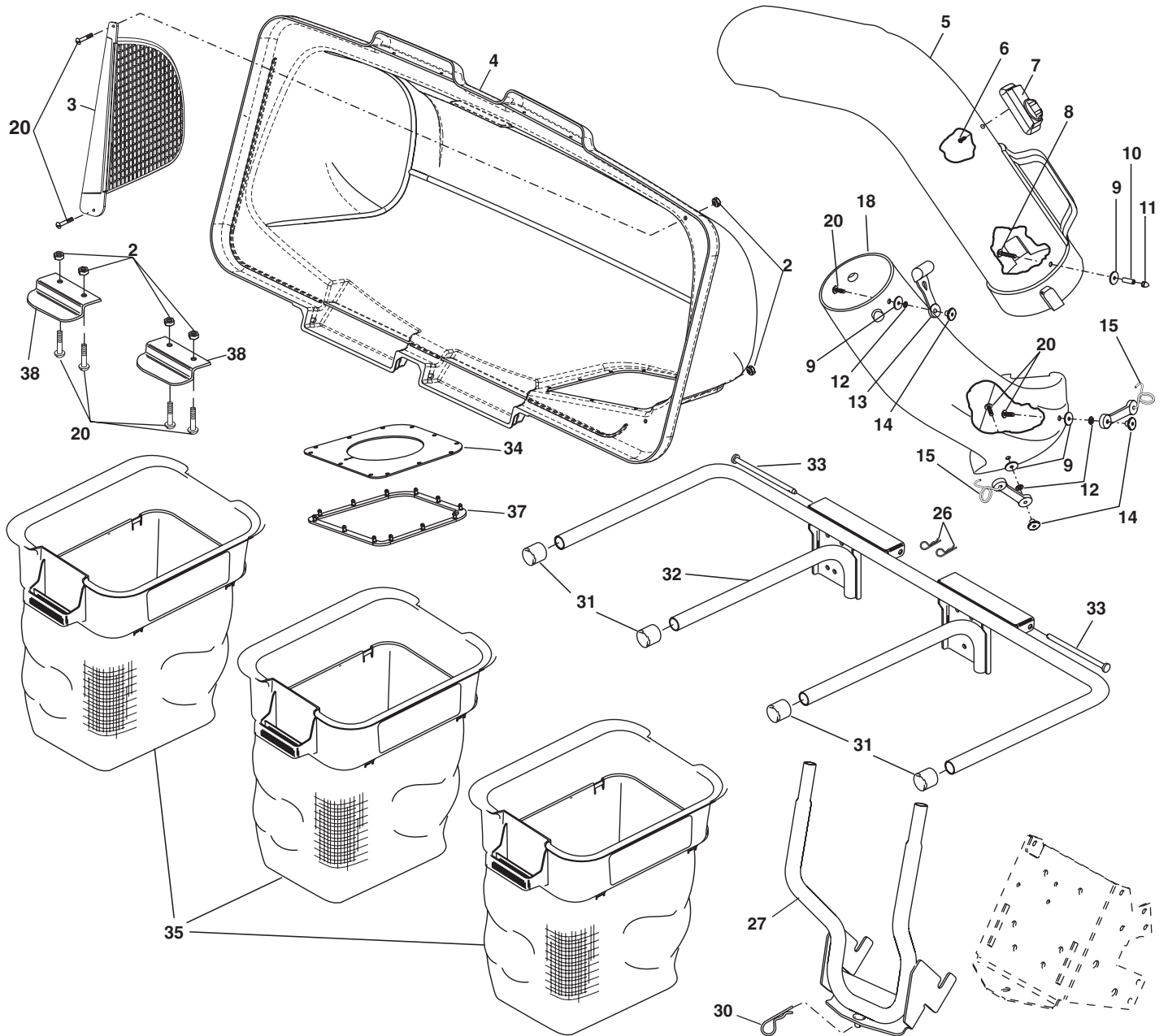

KEY NO.	PART NO.	DESCRIPTION
2	532069180	Nut, Crownlock #10-24
3	532192709	Screen, Cover
4	532195373	Cover Assembly (Includes 34, 37)
5	532411397	Chute, Upper
6	818021008	Screw, Special #10-14x1/2
7	532130933	Full Bag Indicator
8	532087175	Screw, #10-24 x 1-1/8
9	819061216	Washer 3/16x3/4x16 Ga.
10	532007206	Spacer, Split
11	532060867	Nut, Acorn #10-24
12	810071000	Washer, lock
13	532109808	Latch, Chute
14	532125004	Nut, Weld
15	532160793	Latch

KEY NO.	PART NO.	DESCRIPTION
18	532405455	Chute, Lower
20	871161010	Screw #10-24 x 5/8
26	532004939	Spring, Retainer
27	532198128	Support Assembly
30	532165898	Spring, Retainer
31	532174083	Plug, Tubing End
32	532176990	Bagger, Frame
33	532192786	Pin, Hinge
34	532192550	Gasket, Cover
35	532400226	Container
37	532192603	Seal, Cover
38	532130895	Latch Handle, Cover
--	532411792	Owner's Manual, English/French
--	532411793	Owner's Manual, Spanish