



531 30 97-18

420GN

**2000 Watt Portable Generator
Operator's Manual**



0 24847 02584 6

Thank you for purchasing this quality-built Husqvarna generator. We are pleased that you've placed your confidence in the Husqvarna brand. When operated and maintained according to the instructions in this manual, your Husqvarna generator will provide many years of dependable service.

This manual contains safety information to make you aware of the hazards and risks associated with generator products and how to avoid them. This generator is designed and intended only for supplying electrical power for operating compatible electrical lighting, appliances, tools and motor loads, and is not intended for any other purpose. It is important that you read and understand these instructions thoroughly before attempting to start or operate this equipment. **Save these instructions for future reference.**

This generator requires final assembly before use. Refer to the *Assembly* section of this manual for instructions on final assembly procedures. Follow the instructions completely.

Where to Find Us

You never have to look far to find Briggs & Stratton support and service for your generator. Consult your Yellow Pages. There are over 30,000 Briggs & Stratton authorized service dealers worldwide who provide quality service. You can also contact Husqvarna Customer Service by phone at **(877) 224-0458**, or on the Internet at www.usa.husqvarna.com.

Generator

Model Number

--	--	--	--	--	--	--

Revision

--	--

Serial Number

--	--	--	--	--	--	--	--	--	--	--	--

Date Purchased

--	--	--	--	--	--

Briggs & Stratton Power Products Group, LLC
900 North Parkway
Jefferson, WI 53549

Copyright © 2007 Briggs & Stratton Power Products Group, LLC. All rights reserved. No part of this material may be reproduced or transmitted in any form by any means without the express written permission of Briggs & Stratton Power Products Group, LLC.

Husqvarna® is a registered trademark of Husqvarna AB and is used under license to Briggs & Stratton Power Products Group, LLC.

Table of Contents

Operator Safety	4
Equipment Description	4
Safety Rules	4
Assembly	7
Unpack Generator	7
Install Wheel Kit	7
Add Engine Oil	7
Add Fuel	7
System Ground	8
Connecting to a Building's Electrical System	8
Generator Location	8
Features and Controls	9
Cord Sets and Receptacles	10
Operation	11
Starting the Engine	11
Connecting Electrical Loads	11
Stopping the Engine	11
Charging a Battery	12
Cold Weather Operation	12
Don't Overload Generator	14
Maintenance	15
Generator Maintenance	15
Engine Maintenance	15
Storage	16
Troubleshooting	17
Warranty	18
Generator Owner Warranty	18
Specifications	20
Product Specifications	20

Safety

Assembly

Controls

Operation

Maintenance

Troubleshooting

Warranty

Operator Safety

Equipment Description



Read this manual carefully and become familiar with your generator. Know its applications, its limitations and any hazards involved.

The generator is an engine-driven, revolving field, alternating current (AC) generator. It was designed to supply electrical power for operating compatible electrical lighting, appliances, tools and motor loads. The generator's revolving field is driven at about 3,600 rpm by a single-cylinder engine.

NOTICE

Exceeding generators wattage/amperage capacity can damage generator and/or electrical devices connected to it.

- DO NOT exceed the generator's wattage/amperage capacity. See *Don't Overload Generator* in the *Operation* section.

Every effort has been made to ensure that the information in this manual is both accurate and current. However, the manufacturer reserves the right to change, alter or otherwise improve the generator and this documentation at any time without prior notice.

The Emission Control System for this generator is warranted for standards set by the Environmental Protection Agency and the California Air Resources Board.

Safety Rules



This is the safety alert symbol. It is used to alert you to potential personal injury hazards. Obey all safety messages that follow this symbol to avoid possible injury or death.

The safety alert symbol (▲) is used with a signal word (**DANGER, WARNING, CAUTION**), a pictorial and/or a safety message to alert you to hazards. **DANGER** indicates a hazard which, if not avoided, will result in death or serious injury. **WARNING** indicates a hazard which, if not avoided, could result in death or serious injury. **CAUTION** indicates a hazard which, if not avoided, might result in minor or moderate injury. **NOTICE** indicates a situation that could result in equipment damage. Follow safety messages to avoid or reduce the risk of injury or death.

The manufacturer cannot possibly anticipate every possible circumstance that might involve a hazard. The warnings in this manual, and the tags and decals affixed to the unit are, therefore, not all-inclusive. If you use a procedure, work method or operating technique that the manufacturer does not specifically recommend, you must satisfy yourself that it is safe for you and others. You must also make sure that the procedure, work method or operating technique that you choose does not render the generator unsafe.

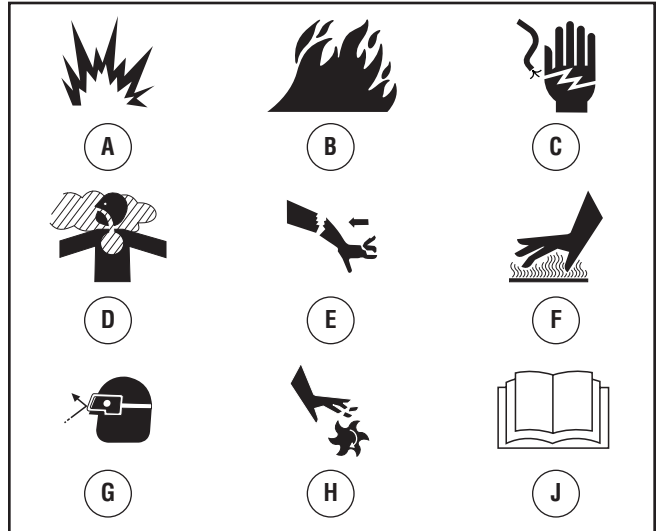

Hazard Symbols and Meanings



- A - Explosion
- B - Fire
- C - Electric Shock
- D - Toxic Fumes
- E - Kickback

- F - Hot Surface
- G - Flying Objects
- H - Moving Parts
- J - Read Manual

⚠ DANGER



	<p>Storage batteries give off explosive hydrogen gas during recharging.</p> <p>Hydrogen gas stays near battery for a long time after battery has been charged.</p> <p>Slightest spark will ignite hydrogen and cause explosion.</p> <p>You can be blinded or severely injured.</p>
	<p>Battery electrolyte fluid contains acid and is extremely caustic.</p> <p>Contact with battery fluid will cause severe chemical burns.</p>

- DO NOT allow any open flame, spark, heat, or lit cigarette during and for several minutes after charging a battery.
- Wear protective goggles, rubber apron, and rubber gloves.

⚠ DANGER

Using a generator indoors CAN KILL YOU IN MINUTES.

Generator exhaust contains carbon monoxide. This is a poison you cannot see or smell.

 	
<p>NEVER use inside a home or garage, EVEN IF doors and windows are open.</p>	<p>Only use OUTSIDE and far away from windows, doors, and vents.</p>

⚠ WARNING



	<p>Running engine gives off carbon monoxide, an odorless, colorless, poison gas.</p> <p>Breathing carbon monoxide can cause headache, fatigue, dizziness, vomiting, confusion, seizures, nausea, fainting or death.</p>
---	---

- Operate generator ONLY outdoors.
- Install a battery operated carbon monoxide alarm near the bedrooms.
- Keep exhaust gas from entering a confined area through windows, doors, ventilation intakes, or other openings.
- DO NOT start or run engine indoors or in an enclosed area, (even if windows and doors are open), including the generator compartment of a recreational vehicle (RV).

⚠ WARNING

The engine exhaust from this product contains chemicals known to the State of California to cause cancer, birth defects, or other reproductive harm.

⚠ WARNING

	<p>Fuel and its vapors are extremely flammable and explosive.</p>
	<p>Fire or explosion can cause severe burns or death.</p>

WHEN ADDING OR DRAINING FUEL

- Turn generator OFF and let it cool at least 2 minutes before removing fuel cap. Loosen cap slowly to relieve pressure in tank.
- Fill or drain fuel tank outdoors.
- DO NOT overfill tank. Allow space for fuel expansion.
- If fuel spills, wait until it evaporates before starting engine.
- Keep fuel away from sparks, open flames, pilot lights, heat, and other ignition sources.
- DO NOT light a cigarette or smoke.

WHEN STARTING EQUIPMENT

- Ensure spark plug, muffler, fuel cap, and air cleaner are in place.
- DO NOT crank engine with spark plug removed.

WHEN OPERATING EQUIPMENT

- DO NOT tip engine or equipment at angle which causes fuel to spill.
- This generator is not for use in mobile equipment or marine applications.

WHEN TRANSPORTING OR REPAIRING EQUIPMENT

- Transport/repair with fuel tank EMPTY or with fuel shutoff valve OFF.
- Disconnect spark plug wire.

WHEN STORING FUEL OR EQUIPMENT WITH FUEL IN TANK

- Store away from furnaces, stoves, water heaters, clothes dryers, or other appliances that have pilot light or other ignition source because they can ignite fuel vapors.



⚠ WARNING



- This generator does not meet U. S. Coast Guard Regulation 33CFR-183 and should not be used on marine applications.
- Failure to use the appropriate U. S. Coast Guard approved generator could result in death or serious injury and/or property damage.



⚠ WARNING



	<p>Starter cord kickback (rapid retraction) can result in bodily injury. Kickback will pull hand and arm toward engine faster than you can let go.</p> <p>Broken bones, fractures, bruises, or sprains could result.</p>
---	--

- When starting engine, pull cord slowly until resistance is felt and then pull rapidly to avoid kickback.
- NEVER start or stop engine with electrical devices plugged in and turned on.

 WARNING	
	<p>Generator produces hazardous voltage.</p> <p>Failure to isolate generator from power utility can result in death or injury to electric utility workers due to backfeed of electrical energy.</p>
<ul style="list-style-type: none"> • When using generator for backup power, notify utility company. Use approved transfer equipment to isolate generator from electric utility. • Use a ground fault circuit interrupter (GFCI) in any damp or highly conductive area, such as metal decking or steel work. • DO NOT touch bare wires or receptacles. • DO NOT use generator with electrical cords which are worn, frayed, bare or otherwise damaged. • DO NOT operate generator in the rain or wet weather. • DO NOT handle generator or electrical cords while standing in water, while barefoot, or while hands or feet are wet. • DO NOT allow unqualified persons or children to operate or service generator. 	

 WARNING	
	<p>Contact with muffler area can result in serious burns.</p>
	<p>Exhaust heat/gases can ignite combustibles, structures or damage fuel tank causing a fire.</p>
<ul style="list-style-type: none"> • DO NOT touch hot parts and AVOID hot exhaust gases. • Allow equipment to cool before touching. • Keep at least 5 feet (1.5 m) of clearance on all sides of generator including overhead. • Code of Federal Regulation (CFR) Title 36 Parks, Forests, and Public Property require equipment powered by an internal combustion engine to have a spark arrester, maintained in effective working order, complying to USDA Forest service standard 5100-1C or later revision. In the State of California a spark arrester is required under section 4442 of the California Public resources code. Other states may have similar laws. 	

 WARNING	
	<p>Unintentional sparking can result in fire or electric shock.</p>
	
<p>WHEN ADJUSTING OR MAKING REPAIRS TO YOUR GENERATOR</p> <ul style="list-style-type: none"> • Disconnect the spark plug wire from the spark plug and place the wire where it cannot contact spark plug. <p>WHEN TESTING FOR ENGINE SPARK</p> <ul style="list-style-type: none"> • Use approved spark plug tester. • DO NOT check for spark with spark plug removed. 	

 WARNING	
	<p>Starter and other rotating parts can entangle hands, hair, clothing, or accessories.</p>
<ul style="list-style-type: none"> • NEVER operate generator without protective housing or covers. • DO NOT wear loose clothing, jewelry or anything that may be caught in the starter or other rotating parts. • Tie up long hair and remove jewelry. 	

 CAUTION	
<p>Excessively high operating speeds increase risk of injury and damage to generator.</p> <p>Excessively low speeds impose a heavy load.</p>	
<ul style="list-style-type: none"> • DO NOT tamper with governed speed. Generator supplies correct rated frequency and voltage when running at governed speed. • DO NOT modify generator in any way. 	

NOTICE	
<p>Exceeding generators wattage/amperage capacity can damage generator and/or electrical devices connected to it.</p>	
<ul style="list-style-type: none"> • DO NOT exceed the generator's wattage/amperage capacity. See <i>Don't Overload Generator</i> in the <i>Operation</i> section. • Start generator and let engine stabilize before connecting electrical loads. • Connect electrical loads in OFF position, then turn ON for operation. • Turn electrical loads OFF and disconnect from generator before stopping generator. 	

NOTICE	
<p>Improper treatment of generator can damage it and shorten its life.</p>	
<ul style="list-style-type: none"> • Use generator only for intended uses. • If you have questions about intended use, ask dealer or contact local service center. • Operate generator only on level surfaces. • DO NOT expose generator to excessive moisture, dust, dirt, or corrosive vapors. • DO NOT insert any objects through cooling slots. • If connected devices overheat, turn them off and disconnect them from generator. • Shut off generator if: <ul style="list-style-type: none"> -electrical output is lost; -equipment sparks, smokes, or emits flames; -unit vibrates excessively. 	

Assembly

Your generator requires some assembly and is ready for use after it has been properly serviced with the recommended fuel and oil.

If you have any problems with the assembly of your generator, please call the generator helpline at **(877) 224-0458**. If calling for assistance, please have the model, revision, and serial number from the data tag available. See *Generator Controls and Features* for data tag location.

Unpack Generator

1. Set the carton on a rigid, flat surface.
2. Remove everything from carton except generator.
3. Open carton completely by cutting each corner from top to bottom.
4. Leave generator on carton to install wheel kit.

The generator is supplied with:

- Engine oil bottle
- Battery charge cables
- Operator's manual
- Engine operator's manual
- Wheel kit

Install Wheel Kit

The wheel kit is designed to greatly improve the portability of your generator.

NOTE: Wheel kit is not intended for over-the-road use.

You will need the following tool to install these components:

- Needle Nose Pliers

Install the wheel kit as follows:

1. Tip generator up onto handle end.
2. Slide axle (A) through both axle mounting brackets on cradle frame.

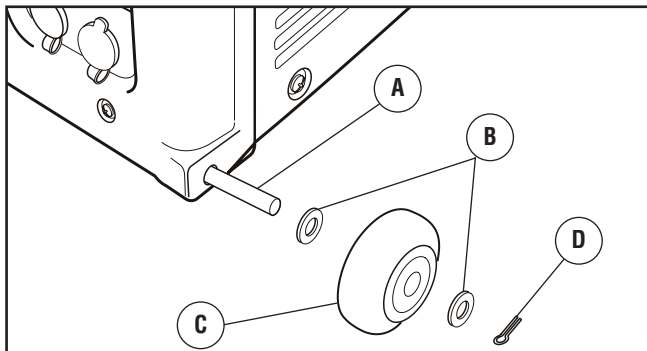

3. Slide a flat washer (B) and wheel (C) over the axle.
4. Slide another flat washer (B) over the axle.
5. Insert cotter pin (D) through hole on axle. Bend the ends of the cotter pin over the axle with a needle-nose pliers to retain wheel.
6. Repeat step 3 thru 5 to secure second wheel.
7. Tip generator back down onto wheels.

Add Engine Oil

- Place generator on a level surface.

NOTE: Verify provided oil bottles are the correct viscosity for current ambient temperature.

- Refer to engine operator's manual and follow oil recommendations and instructions.

NOTICE

Any attempt to crank or start the engine before it has been properly filled with the recommended oil will result in equipment failure.

- Refer to engine manual for oil information.
- Damage to equipment resulting from failure to follow this instruction will void warranty.

NOTE: Check oil often during engine break-in. Refer to engine operator's manual for recommendations.

Add Fuel

NOTE: Refer to engine operator's manual and follow fuel recommendations.

WARNING



Fuel and its vapors are extremely flammable and explosive.



Fire or explosion can cause severe burns or death.

WHEN ADDING FUEL

- Turn generator OFF and let it cool at least 2 minutes before removing fuel cap. Loosen cap slowly to relieve pressure in tank.
- Fill fuel tank outdoors.
- DO NOT overfill tank. Allow space for fuel expansion.
- If fuel spills, wait until it evaporates before starting engine.
- Keep fuel away from sparks, open flames, pilot lights, heat, and other ignition sources.
- DO NOT light a cigarette or smoke.

1. Clean area around fuel fill cap, remove cap.
2. Slowly add unleaded gasoline (A) to fuel tank (B). Be careful not to overfill. Allow about 1.5" of tank space (C) for fuel expansion as shown.

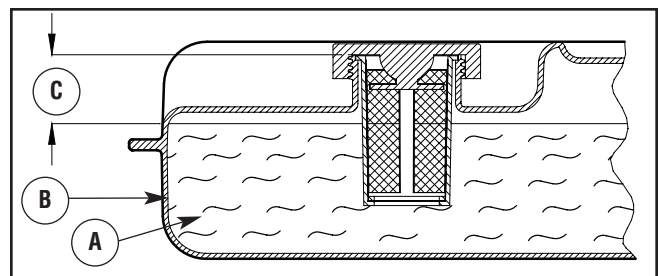

3. Install fuel cap and let any spilled fuel evaporate before starting engine.

System Ground

The generator has a system ground that connects the generator frame components to the ground terminals on the AC output receptacles. The system ground is connected to the AC neutral wire (the neutral is bonded to the generator frame).



Special Requirements

There may be Federal or State Occupational Safety and Health Administration (OSHA) regulations, local codes, or ordinances that apply to the intended use of the generator. Please consult a qualified electrician, electrical inspector, or the local agency having jurisdiction:

- In some areas, generators are required to be registered with local utility companies.
- If the generator is used at a construction site, there may be additional regulations which must be observed.



Connecting to a Building's Electrical System

Connections for standby power to a building's electrical system must be made by a qualified electrician. The connection must isolate the generator power from utility power or other alternative power sources and must comply with all applicable laws and electrical codes.



 WARNING	
	Generator produces hazardous voltage. Failure to isolate generator from power utility can result in death or injury to electric utility workers due to backfeed of electrical energy.
<ul style="list-style-type: none"> • When using generator for backup power, notify utility company. Use approved transfer equipment to isolate generator from electric utility. • Use a ground fault circuit interrupter (GFCI) in any damp or highly conductive area, such as metal decking or steel work. • DO NOT touch bare wires or receptacles. • DO NOT use generator with electrical cords which are worn, frayed, bare or otherwise damaged. • DO NOT operate generator in the rain or wet weather. • DO NOT handle generator or electrical cords while standing in water, while barefoot, or while hands or feet are wet. • DO NOT allow unqualified persons or children to operate or service generator. 	

Generator Location

Clearances and Air Movement

 WARNING	
	Exhaust heat/gases can ignite combustibles, structures or damage fuel tank causing a fire.
<ul style="list-style-type: none"> • Keep at least 5 ft. (1.5 m) clearance on all sides of generator including overhead. 	

Place generator outdoors in an area that will not accumulate deadly exhaust gas. DO NOT place generator where exhaust gas (A) could accumulate and enter inside or be drawn into a potentially occupied building. Ensure exhaust gas is kept away from any windows, doors, ventilation intakes, or other openings that can allow exhaust gas to collect in a confined area. Prevailing winds and air currents should be taken into consideration when positioning generator.

 DANGER	
Using a generator indoors CAN KILL YOU IN MINUTES. Generator exhaust contains carbon monoxide. This is a poison you cannot see or smell.	
 NEVER use inside a home or garage, EVEN IF doors and windows are open.	 Only use OUTSIDE and far away from windows, doors, and vents.

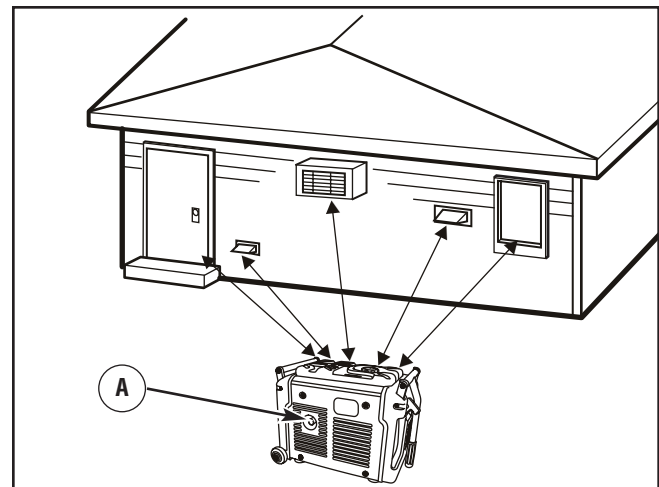

Features and Controls



Read this Operator's Manual and safety rules before operating your generator.

Compare the illustrations with your generator, to familiarize yourself with the locations of various controls and adjustments. Save this manual for future reference.

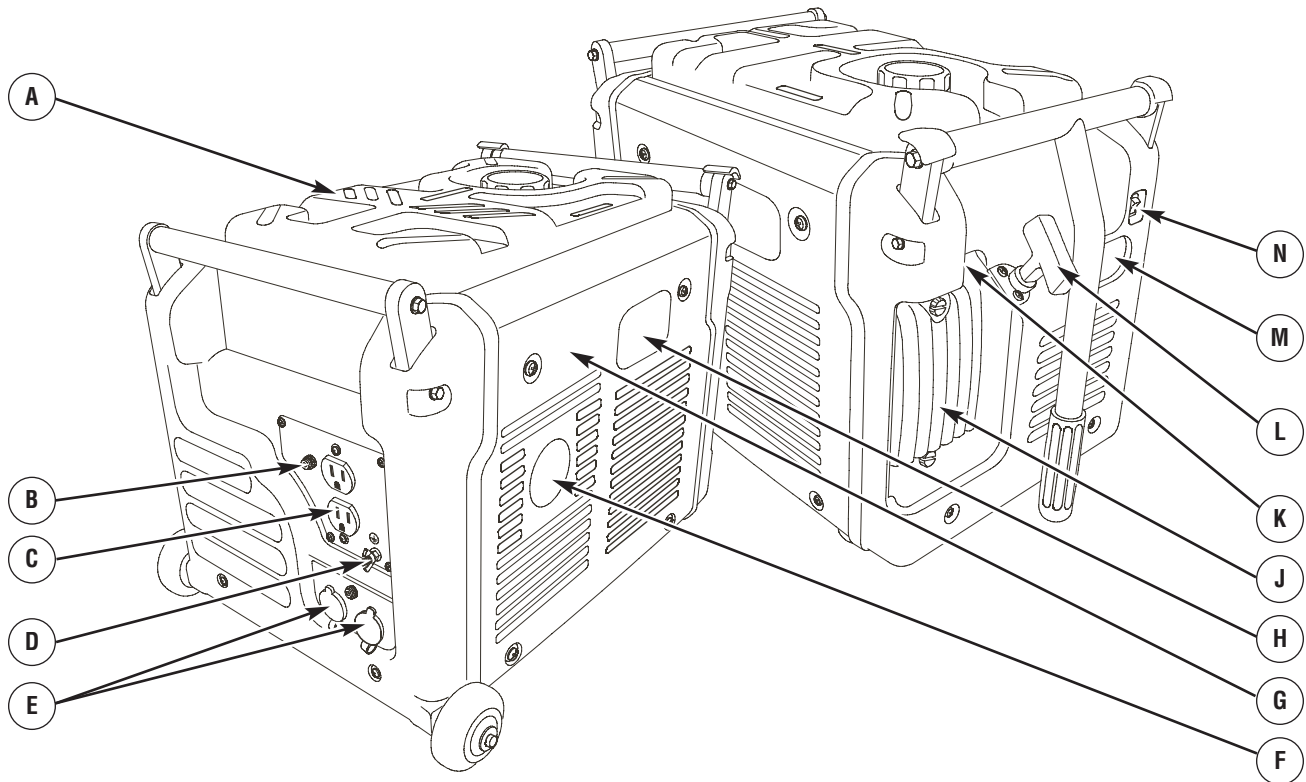

Controls

A - Fuel Tank — Capacity of 1.32 U.S. gallons (5.0 L).

B - Circuit Breaker (AC) — A push-to-reset circuit breaker is provided to protect the receptacle and generator against electrical overload.

C - 120 Volt AC, 15 Amp, Duplex Receptacle — May be used to supply electrical power for the operation of 120 Volt AC, 15 Amp, single phase, 60 Hz electrical, lighting, appliance, tool, and motor loads.

D - Grounding Fastener — Consult your local agency having jurisdiction for grounding requirements in your area.

E - 12 Volt DC, 8.3 Amp Accessory Jacks — May be used to power 12 Volt DC electrical devices or recharge 12 Volt DC batteries.

F - Spark Arrester Muffler — Exhaust muffler lowers engine noise and is equipped with a spark arrester screen.

G - Data Tag — Provides model, revision, and serial number of generator. Please have these readily available when calling for assistance.

H - Spark Plug — Access to engine spark plug.

J - Air Cleaner — Protects engine by filtering dust and debris out of intake air.

K - Choke Lever — Used when starting a cold engine.

L - Recoil Starter — Used to start the engine.

M - Fuel Valve — Used to turn fuel supply on and off to engine.

N - Engine Switch — Set this switch to “On” before using recoil starter. Set switch to “Off” to stop engine.

Items Not Shown:

Engine Identification — Provides model, type and code of engine. Please have these readily available if calling for assistance.

Oil Drain Plug — Drain engine oil here.



Oil Fill Cap — Check and fill engine with oil here.

Cord Sets and Receptacles

Use only high quality, well-insulated, grounded extension cords with the generator's 120 Volt duplex receptacle. Inspect extension cords before each use.

Check the ratings of all extension cords before you use them. Extension cord sets used should be rated for 125 Volt AC loads at 15 Amps or greater for most electrical devices. Some devices, however, may not require this type of extension cord. Check the operator's manuals of those devices for the manufacturer's recommendations.

Keep extension cords as short as possible to minimize voltage drop.

 WARNING	
	Overloaded electrical cords can overheat, arc, and burn resulting in death, bodily injury, and/or property damage.
<ul style="list-style-type: none"> • ONLY use cords rated for your loads. • Follow all safeties on electrical cords. 	

120 Volt AC, 15 Amp, Duplex Receptacle

The duplex receptacle is protected against overload by a push-to-reset circuit breaker.

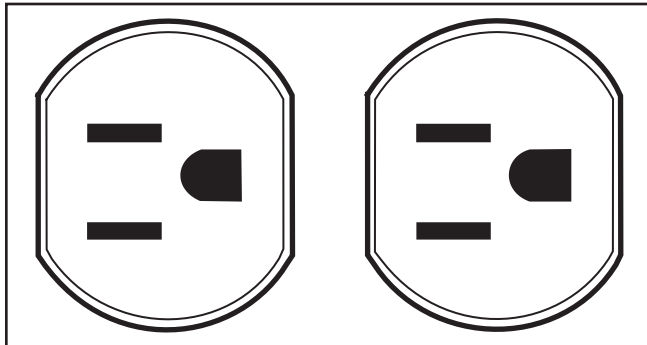

Use each receptacle to operate 120 Volt AC, single-phase, 60 Hz electrical loads requiring up to 1,800 watts (1,8 kW) at 15 Amps of current. Use cord sets that are rated for 125 Volt AC loads at 15 Amps (or greater).

NOTICE	
Receptacles may be marked with rating value greater than generator output capacity.	
<ul style="list-style-type: none"> • NEVER attempt to power a device requiring more amperage than generator or receptacle can supply. • DO NOT overload the generator. See <i>Don't Overload Generator</i>. 	

12 Volt DC Accessory Jack

These receptacles allows you to recharge a 12 Volt automotive or utility style storage battery with the battery charge cable provided. Camping-style air pumps, lanterns, fans, or other 12 Volt devices having a cigarette lighter-type plug may also be powered by these outlets.

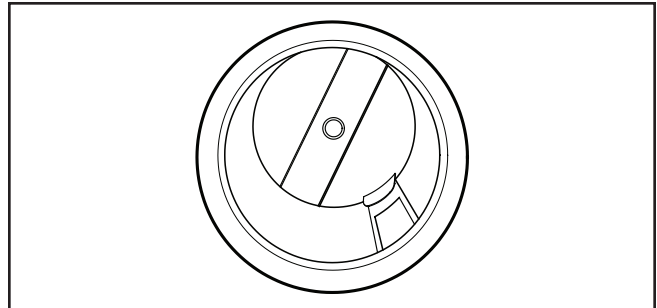

These receptacles can not recharge 6 Volt batteries and can not be used to crank an engine having a discharged battery. See *Charging a Battery* before attempting to recharge a battery.

Operation

Starting the Engine

Disconnect all electrical loads from the generator. Use the following start instructions:

1. Make sure unit is on a level surface.

IMPORTANT: Failure to start and operate the unit on a level surface will cause the unit not to start or shut down during operation.

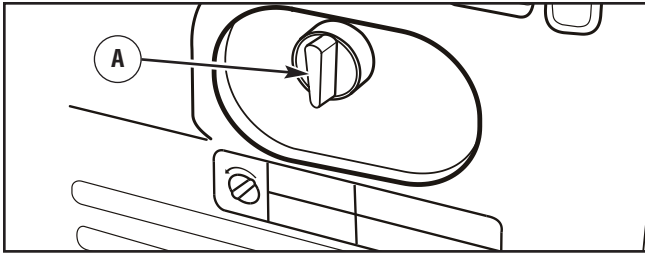

2. Turn fuel valve (A) to “Open” position (fully clockwise).



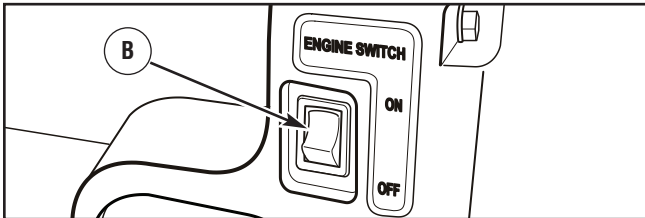

3. Place the engine switch (B) in the “On” position.



4. Start engine according to instructions given in the engine operator’s manual.

 WARNING	
	Starter cord kickback (rapid retraction) can result in bodily injury. Kickback will pull hand and arm toward engine faster than you can let go. Broken bones, fractures, bruises, or sprains could result.
<ul style="list-style-type: none">• When starting engine, pull cord slowly until resistance is felt and then pull rapidly to avoid kickback.• NEVER start or stop engine with electrical devices plugged in and turned on.	

NOTE: If engine starts after 3 pulls, but fails to run for more than 10 seconds, check for proper oil level in crankcase. This unit may be equipped with a low oil protection device. See engine operator’s manual.

 WARNING	
	Contact with muffler area can result in serious burns.
	Exhaust heat/gases can ignite combustibles, structures or damage fuel tank causing a fire.
<ul style="list-style-type: none">• DO NOT touch hot parts and AVOID hot exhaust gases.• Allow equipment to cool before touching.• Keep at least 5 feet (1.5 m) of clearance on all sides of generator including overhead.• Code of Federal Regulation (CFR) Title 36 Parks, Forests, and Public Property require equipment powered by an internal combustion engine to have a spark arrester, maintained in effective working order, complying to USDA Forest service standard 5100-1C or later revision. In the State of California a spark arrester is required under section 4442 of the California Public resources code. Other states may have similar laws.	

Connecting Electrical Loads

1. Let engine stabilize and warm up for a few minutes after starting.
2. Plug in and turn on the desired 120 Volt AC, single phase, 60 Hz electrical loads.

NOTE:

- DO NOT connect 240 Volt loads to the 120 Volt duplex receptacle.
- DO NOT connect 3-phase loads to the generator.
- DO NOT connect 50 Hz loads to the generator.
- DO NOT OVERLOAD THE GENERATOR. See *Don't Overload Generator*.



NOTICE	
Exceeding generators wattage/amperage capacity can damage generator and/or electrical devices connected to it.	
<ul style="list-style-type: none">• DO NOT exceed the generator’s wattage/amperage capacity. See <i>Don't Overload Generator</i> in the <i>Operation</i> section.• Start generator and let engine stabilize before connecting electrical loads.• Connect electrical loads in OFF position, then turn ON for operation.• Turn electrical loads OFF and disconnect from generator before stopping generator.	

Stopping the Engine

1. Turn OFF and unplug all electrical loads from generator panel receptacles. NEVER start or stop engine with electrical devices plugged in and turned ON.
2. Let engine run at no-load for several minutes to stabilize internal temperatures of engine and generator.
3. Move engine switch to the “Off” position.
4. Turn the fuel valve to the “Close” position (fully counterclockwise).

Charging a Battery

Your generator has the capability of recharging a discharged 12 Volt automotive or utility style storage battery. **DO NOT** use the unit to charge any 6 Volt batteries. **DO NOT** use the unit to crank an engine having a discharged battery.

 DANGER	
	Storage batteries give off explosive hydrogen gas during recharging. Hydrogen gas stays near battery for a long time after battery has been charged. Slightest spark will ignite hydrogen and cause explosion.
	You can be blinded or severely injured. Battery electrolyte fluid contains acid and is extremely caustic. Contact with battery fluid will cause severe chemical burns.
<ul style="list-style-type: none">• DO NOT allow any open flame, spark, heat, or lit cigarette during and for several minutes after charging a battery.• Wear protective goggles, rubber apron, and rubber gloves.	

To recharge 12 Volt batteries, proceed as follows:

1. If necessary, clean battery posts or terminals.
2. Check fluid level in all battery cells. If necessary, add **ONLY** distilled water to cover separators in battery cells. **DO NOT use tap water.**
3. If the battery is equipped with vent caps, make sure they are installed and are tight.
4. Connect battery charge cable connector plug to the 12 Volt DC panel receptacle.
5. Connect battery charge cable clamp with **red** handle to battery post or terminal indicated by **Positive, POS** or **(+)**.

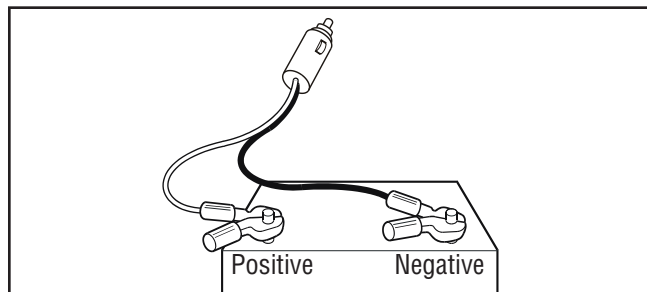

6. Connect battery charge cable clamp with **black** handle to battery post or terminal indicated by **Negative, NEG**, or **(-)**.
7. Start generator as described in *Starting The Engine*. Let the engine run while battery recharges.
8. When battery has charged, shut down engine as described in *Stopping The Engine*.

NOTE: Use an automotive hydrometer to test battery state of charge and condition. Follow the hydrometer manufacturer's instructions carefully. Generally, a battery is considered to be at 100% state of charge when specific gravity of its fluid (as measured by hydrometer) is 1.260 or higher.

Cold Weather Operation

Under certain weather conditions (temperatures below 40°F [4°C] combined with high humidity), your generator may experience icing of the carburetor and/or the crankcase breather system. To reduce this problem, you need to perform the following:

1. Make sure generator has clean, fresh fuel.
2. Open fuel valve (turn valve to open position).
3. Use SAE 5W-30 oil (synthetic preferred, see engine operator's manual).
4. Check oil level daily or after every eight (8) hours of operation.
5. Maintain generator following maintenance schedule in engine operator's manual.
6. Shelter unit from elements.

Creating a Temporary Shelter

1. In an emergency, use the original shipping carton.
2. Cut off top carton flaps and one long side of carton to expose muffler side of unit. If required, tape up other sides of carton to fit over generator as shown.

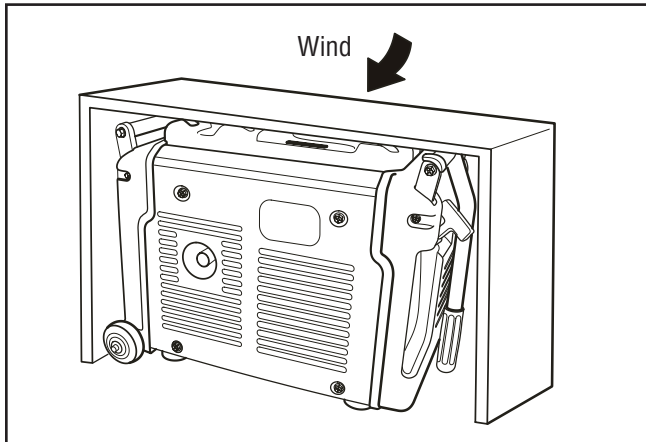

NOTE: If required, remove wheel kit to fit carton over generator as shown.

3. Cut appropriate slots to access receptacles of unit.
4. Face exposed end away from wind and elements.
5. Locate generator as described in the section *Generator Location*. Keep exhaust gas from entering a confined area through windows, doors, ventilation intakes or other openings.

WARNING	
	Running engine gives off carbon monoxide, an odorless, colorless, poison gas. Breathing carbon monoxide can cause headache, fatigue, dizziness, vomiting, confusion, seizures, nausea, fainting or death.
<ul style="list-style-type: none"> • Operate generator ONLY outdoors. • Install a battery operated carbon monoxide alarm near the bedrooms. • Keep exhaust gas from entering a confined area through windows, doors, ventilation intakes, or other openings. • DO NOT start or run engine indoors or in an enclosed area, (even if windows and doors are open), including the generator compartment of a recreational vehicle (RV). 	

6. Start generator as described in the section *Starting the Engine*, then place carton over generator. Keep at least 5 ft. (1.5 m) clearance on all sides of generator including overhead with shelter in place.

WARNING	
	Contact with muffler area can result in serious burns.
	Exhaust heat/gases can ignite combustibles, structures or damage fuel tank causing a fire.
<ul style="list-style-type: none"> • DO NOT touch hot parts and AVOID hot exhaust gases. • Allow equipment to cool before touching. • Keep at least 5 feet (1.5 m) of clearance on all sides of generator including overhead. • Remove shelter when temperatures are above 40°F [4°C]. 	

7. Remove shelter when temperatures are above 40°F [4°C].
8. Turn engine OFF and let cool two (2) minutes before refueling. Let any spilled fuel evaporate before starting engine.

Creating a Permanent Shelter

1. Build a structure that will enclose three sides and the top of the generator, making sure muffler side of generator is exposed.

NOTE: Structure should hold enough heat created by the generator to prevent icing problem.

2. DO NOT enclose generator any more than shown.

NOTE: If a wheel kit is installed on the generator, enlarge shelter accordingly.

3. Follow steps 3 through 8 as described previously in *Creating a Temporary Shelter*.

Don't Overload Generator

Capacity

You must make sure your generator can supply enough rated (running) and surge (starting) watts for the items you will power at the same time. Follow these simple steps:

1. Select the items you will power at the same time.
2. Total the rated (running) watts of these items. This is the amount of power your generator must produce to keep your items running. See Wattage Reference Guide.
3. Estimate how many surge (starting) watts you will need. Surge wattage is the short burst of power needed to start electric motor-driven tools or appliances such as a circular saw or refrigerator. Because not all motors start at the same time, total surge watts can be estimated by adding only the item(s) with the highest additional surge watts to the total rated watts from step 2.

Example:

Tool or Appliance	Rated (Running) Watts	Additional Surge (Starting) Watts
Window Fan	300	600
Deep Freezer	500	500
Television	500	—
Security System	180	—
Light (75 Watts)	75	—
	1555 Total Running Watts	600 Highest Surge Watts

Total Rated (Running) Watts = 1555
 Highest Additional Surge Watts = 600
 Total Generator Output Required = 2155

Power Management

To prolong the life of your generator and attached devices, it is important to take care when adding electrical loads to your generator. There should be nothing connected to the generator outlets before starting its engine. The correct and safe way to manage generator power is to sequentially add loads as follows:

1. With nothing connected to the generator, start the engine as described in this manual.
2. Plug in and turn on the first load, preferably the largest load you have.
3. Permit the generator output to stabilize (engine runs smoothly and attached device operates properly).
4. Plug in and turn on the next load.
5. Again, permit the generator to stabilize.
6. Repeat steps 4 and 5 for each additional load.

NEVER add more loads than the generator capacity. Take special care to consider surge loads in generator capacity, as described above.

Wattage Reference Guide

Tool or Appliance	Rated* (Running) Watts	Additional Surge (Starting) Watts
Essentials		
Light Bulb - 75 watt	75	—
Deep Freezer	500	500
Sump Pump	800	1200
Refrigerator/Freezer - 18 cf	800	1600
Water Well Pump - 1/3 hp	1000	2000
Heating/Cooling		
Window AC - 10,000 BTU	1200	1800
Window Fan	300	600
Furnace Fan Blower - 1/2 hp	800	1300
Kitchen		
Microwave Oven - 1000 Watt	1000	—
Coffee Maker	1500	—
Electric Stove - Single Element	1500	—
Hot Plate	2500	—
Family Room		
DVD/CD Player	100	—
VCR	100	—
Stereo Receiver	450	—
Color Television - 27 in	500	—
Personal Computer w/17 in monitor	800	—
Other		
Security System	180	—
AM/FM Clock Radio	300	—
Garage Door Opener - 1/2 hp	480	520
Electric Water Heater - 40 gallon	4000	—
DIY/Job Site		
Quartz Halogen Work Light	1000	—
Airless Sprayer - 1/3 hp	600	1200
Reciprocating Saw	960	960
Electric Drill - 1/2 hp	1000	1000
Circular Saw - 7-1/4 in	1500	1500
Miter Saw - 10 in	1800	1800
Table Planer - 6 in	1800	1800
Table Saw/Radial Arm Saw - 10 in	2000	2000
Air Compressor - 1-1/2 hp	2500	2500

* Wattages listed are approximate only. Check tool or appliance for actual wattage.

Maintenance

General Recommendations

Regular maintenance will improve the performance and extend the life of the generator. See an authorized dealer for service.

The generator's warranty does not cover items that have been subjected to operator abuse or negligence. To receive full value from the warranty, the operator must maintain the generator as instructed in this manual and the engine operator's manual.

NOTE: Should you have questions about replacing components on your generator, please call **(877) 224-0458** for assistance.

- Some adjustments will need to be made periodically to properly maintain your generator.
- All maintenance in this manual and the engine operator's manual should be made at least once each season.
- Once a year you should clean or replace the spark plug, clean or replace the air filter. A new spark plug and clean air filter assure proper fuel-air mixture and help your engine run better and last longer. Please refer to your engine operator's manual for more details.

Generator Maintenance

Generator maintenance consists of keeping the unit clean and dry. Operate and store the unit in a clean dry environment where it will not be exposed to excessive dust, dirt, moisture, or any corrosive vapors. Cooling air slots in the generator must not become clogged with snow, leaves, or any other foreign material.

NOTE: DO NOT use water or other liquids to clean generator. Liquids can enter engine fuel system, causing poor performance and/or failure to occur. In addition, if liquid enters generator through cooling air slots, some of the liquid will be retained in voids and cracks of the rotor and stator winding insulation. Liquid and dirt buildup on the generator internal windings will eventually decrease the insulation resistance of these windings.

Cleaning

Daily or before use, look around and underneath the generator for signs of oil or fuel leaks. Clean accumulated debris from inside and outside the generator. Keep the linkage, spring and other engine controls clean. Inspect cooling air slots and openings on generator. These openings must be kept clean and unobstructed.

Engine parts should be kept clean to reduce the risk of overheating and ignition of accumulated debris:

- Use a damp cloth to wipe exterior surfaces clean.

NOTICE

Improper treatment of generator can damage it and shorten its life.

- DO NOT expose generator to excessive moisture, dust, dirt, or corrosive vapors.
- DO NOT insert any objects through cooling slots.

- Use a soft bristle brush to loosen caked on dirt or oil.
- Use a vacuum cleaner to pick up loose dirt and debris.

Engine Maintenance

See the engine operator's manual for instructions on how to properly maintain the engine.



CAUTION

Avoid prolonged or repeated skin contact with used motor oil.

- Used motor oil has been shown to cause skin cancer in certain laboratory animals.
- Thoroughly wash exposed areas with soap and water.



KEEP OUT OF REACH OF CHILDREN. DON'T POLLUTE. CONSERVE RESOURCES. RETURN USED OIL TO COLLECTION CENTERS.

Storage

The generator should be started at least once every seven days and allowed to run at least 30 minutes. If this cannot be done and you must store the unit for more than 30 days, use the following guidelines to prepare it for storage.

Generator Storage



- Clean the generator as outlined in *Cleaning*.
- Check that cooling air slots and openings on generator are open and unobstructed.

Long Term Storage Instructions

Fuel can become stale when stored over 30 days. Stale fuel causes acid and gum deposits to form in the fuel system or on essential carburetor parts. To keep fuel fresh, use Briggs & Stratton FRESH START™ fuel stabilizer, available as a liquid additive or a drip concentrate cartridge.

There is no need to drain gasoline from the engine if a fuel stabilizer is added according to instructions. Run the engine for 2 minutes to circulate the stabilizer throughout the fuel system. The engine and fuel can then be stored up to 24 months.

If gasoline in the engine has not been treated with a fuel stabilizer, it must be drained into an approved container. Run the engine until it stops from lack of fuel. The use of a fuel stabilizer in the storage container is recommended to maintain freshness.



 WARNING	
	Fuel and its vapors are extremely flammable and explosive.
	Fire or explosion can cause severe burns or death.
WHEN STORING FUEL OR EQUIPMENT WITH FUEL IN TANK	
<ul style="list-style-type: none"> • Store away from furnaces, stoves, water heaters, clothes dryers or other appliances that have pilot light or other ignition source because they can ignite fuel vapors. 	
WHEN DRAINING FUEL	
<ul style="list-style-type: none"> • Turn generator OFF and let it cool at least 2 minutes before removing fuel cap. Loosen cap slowly to relieve pressure in tank. • Drain fuel tank outdoors. • Keep fuel away from sparks, open flames, pilot lights, heat, and other ignition sources. • DO NOT light a cigarette or smoke. 	

Storing the Engine

See the engine operator's manual for instructions on how to properly prepare the engine for storage.

Other Storage Tips

1. DO NOT store fuel from one season to another unless it has been treated as described in *Long Term Storage Instructions*.
2. Replace fuel container if it starts to rust. Rust and/or dirt in fuel can cause problems if it's used with this unit.
3. Cover unit with a suitable protective cover that does not retain moisture.

 WARNING	
	Storage covers can be flammable.
<ul style="list-style-type: none"> • DO NOT place a storage cover over a hot generator. • Let equipment cool for a sufficient time before placing the cover on the equipment. 	

4. Store generator in clean, dry area.

Troubleshooting

Problem	Cause	Correction
Engine is running, but no AC output is available.	<ol style="list-style-type: none"> 1. One of the circuit breakers is open. 2. Fault in generator. 3. Poor connection or defective cord set. 4. Connected device is bad. 	<ol style="list-style-type: none"> 1. Reset circuit breaker. 2. Contact authorized service facility. 3. Check and repair. 4. Connect another device that is in good condition.
Engine runs good at no-load but "bogs down" when loads are connected.	<ol style="list-style-type: none"> 1. Short circuit in a connected load. 2. Engine speed is too slow. 3. Generator is overloaded. 4. Shorted generator circuit. 	<ol style="list-style-type: none"> 1. Disconnect shorted electrical load. 2. Contact authorized service facility. 3. See <i>Don't Overload Generator</i> in <i>Operation</i> section. 4. Contact authorized service facility.
Engine will not start; or starts and runs rough.	<ol style="list-style-type: none"> 1. Rocker switch set to "Off". 2. Fuel Valve is in "Off" position. 3. Dirty air cleaner. 4. Out of fuel. 5. Stale fuel. 6. Spark plug wire not connected to spark plug. 7. Bad spark plug. 8. Water in fuel. 9. Flooded. 10. Excessively rich fuel mixture. 11. Intake valve stuck open or closed. 12. Engine has lost compression. 	<ol style="list-style-type: none"> 1. Set switch to "On". 2. Turn fuel valve to "Open" position. 3. Clean or replace air cleaner. 4. Fill fuel tank. 5. Drain fuel tank and carburetor; fill with fresh fuel. 6. Connect wire to spark plug. 7. Replace spark plug. 8. Drain fuel tank and carburetor; fill with fresh fuel. 9. Wait 5 minutes and re-crank engine. 10. Contact authorized service facility. 11. Contact authorized service facility. 12. Contact authorized service facility.
Engine shuts down when running.	Out of fuel.	Fill fuel tank.
Engine lacks power.	<ol style="list-style-type: none"> 1. Load is too high. 2. Dirty air filter. 	<ol style="list-style-type: none"> 1. See <i>Don't Overload Generator</i> in <i>Operation</i> section. 2. Replace air filter.
Engine "hunts" or falters.	Carburetor is running too rich or too lean.	Contact authorized service facility.

HUSQVARNA® PORTABLE GENERATOR OWNER WARRANTY POLICY

Effective February 1, 2006 replaces all undated Warranties and all Warranties dated before February 1, 2006

LIMITED WARRANTY

"Husqvarna® is a registered trademark of Husqvarna AB and is used under license to Briggs & Stratton Power Products. Briggs & Stratton Power Products Group, LLC will repair or replace, free of charge, any part(s) of the portable generator that is defective in material or workmanship or both. Transportation charges on product submitted for repair or replacement under this warranty must be borne by purchaser. This warranty is effective for the time periods and subject to the conditions stated below. For warranty service, find the nearest Authorized Service Dealer in our dealer locator map at www.BRIGGSandSTRATTON.com.

THERE IS NO OTHER EXPRESS WARRANTY. IMPLIED WARRANTIES, INCLUDING THOSE OF MERCHANTABILITY AND FITNESS FOR A PARTICULAR PURPOSE, ARE LIMITED TO ONE YEAR FROM PURCHASE, OR TO THE EXTENT PERMITTED BY LAW. ANY AND ALL IMPLIED WARRANTIES ARE EXCLUDED. LIABILITY FOR INCIDENTAL OR CONSEQUENTIAL DAMAGES ARE EXCLUDED TO THE EXTENT EXCLUSION IS PERMITTED BY LAW. Some states or countries do not allow limitations on how long an implied warranty lasts, and some states or countries do not allow the exclusion or limitation of incidental or consequential damages, so the above limitation and exclusion may not apply to you. This warranty gives you specific legal rights and you may also have other rights which vary from state to state or country to country.

WARRANTY PERIOD

Consumer Use	2 years*
Commercial Use	2 years*

*Second year parts only

The warranty period begins on the date of purchase by the first retail end user, and continues for the period of time stated above. "Consumer Use" means personal residential household use by a retail consumer. "Commercial Use" means all other uses, including use for commercial, income producing or rental purposes. Once equipment has experienced commercial use, it shall thereafter be considered as commercial use for purposes of this warranty.

NO WARRANTY REGISTRATION IS NECESSARY TO OBTAIN WARRANTY ON BRIGGS & STRATTON PRODUCTS. SAVE YOUR PROOF OF PURCHASE RECEIPT. IF YOU DO NOT PROVIDE PROOF OF THE INITIAL PURCHASE DATE AT THE TIME WARRANTY SERVICE IS REQUESTED, THE MANUFACTURING DATE OF THE PRODUCT WILL BE USED TO DETERMINE THE WARRANTY PERIOD.

ABOUT YOUR WARRANTY

We welcome warranty repair and apologize to you for being inconvenienced. Any Authorized Service Dealer may perform warranty repairs. Most warranty repairs are handled routinely, but sometimes requests for warranty service may not be appropriate. For example, warranty service would not apply if equipment damage occurred because of misuse, lack of routine maintenance, shipping, handling, warehousing or improper installation. Similarly, the warranty is void if the manufacturing date or the serial number on the portable generator has been removed or the equipment has been altered or modified. During the warranty period, the Authorized Service Dealer, at its option, will repair or replace any part that, upon examination, is found to be defective under normal use and service. This warranty will not cover the following repairs and equipment:

- **Normal Wear:** Outdoor Power Equipment, like all mechanical devices, needs periodic parts and service to perform well. This warranty does not cover repair when normal use has exhausted the life of a part or the equipment.
- **Installation and Maintenance:** This warranty does not apply to equipment or parts that have been subjected to improper or unauthorized installation or alteration and modification, misuse, negligence, accident, overloading, overspeeding, improper maintenance, repair or storage so as, in our judgment, to adversely affect its performance and reliability. This warranty also does not cover normal maintenance such as air filters, adjustments, fuel system cleaning and obstruction (due to chemical, dirt, carbon, lime, and so forth).
- **Other Exclusions:** This warranty excludes wear items such as o-rings, filters, etc., or malfunctions resulting from accidents, abuse, modifications, alterations, or improper servicing or freezing or chemical deterioration. Accessory parts such as starting batteries, generator adapter cord sets and storage covers are excluded from the product warranty. This warranty excludes used, reconditioned, and demonstration equipment, equipment used for prime power in place of utility power, equipment used in life support applications, and failures due to acts of God and other force majeure events beyond the manufacturers control. 204041E, Rev. -, 8/1/2007

BRIGGS & STRATTON POWER PRODUCTS GROUP, LLC
JEFFERSON, WI, USA



Portable Generator

Product Specifications

Starting Wattage	3,000 watts
Wattage	2,000 watts
Load Current:	
at 120 Volts AC	16.6 Amps
at 12 Volts DC	8.3 Amps
Phase	Single phase
Rated Frequency	60 Hertz
Shipping Weight	87 lb (39.5 kg)
Fuel Capacity	1.32 U.S. gallons (5 L)

Briggs & Stratton Power Products Group, LLC
900 N. Parkway
Jefferson, Wisconsin, 53549 U.S.A.

Exploded View - Main Unit

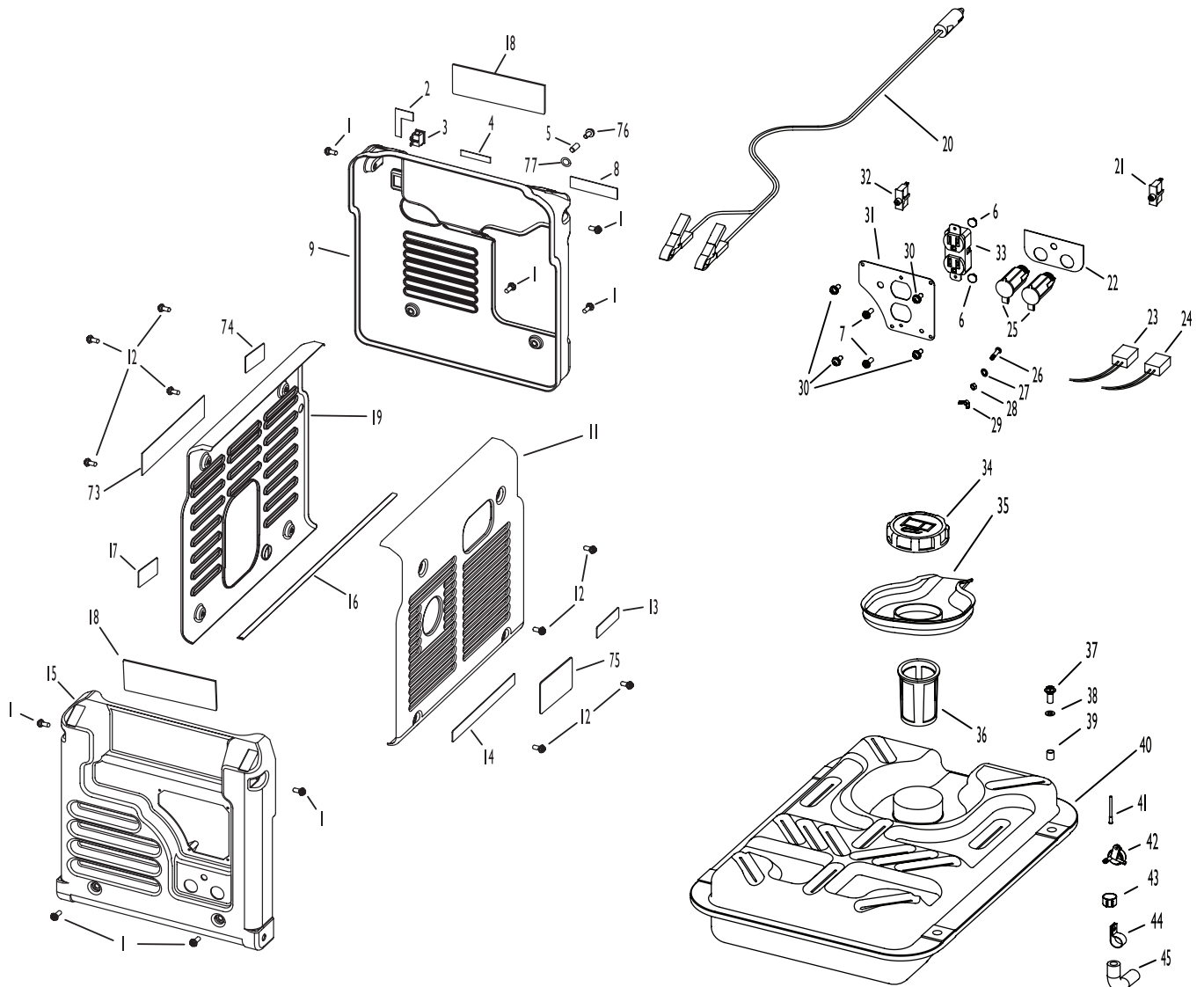

Copyright © 2007 Briggs & Stratton Power Products Group, LLC. All rights reserved. No part of this material may be reproduced or transmitted in any form by any means without the express written permission of Briggs & Stratton Power Products Group, LLC.

Exploded View - Main Unit

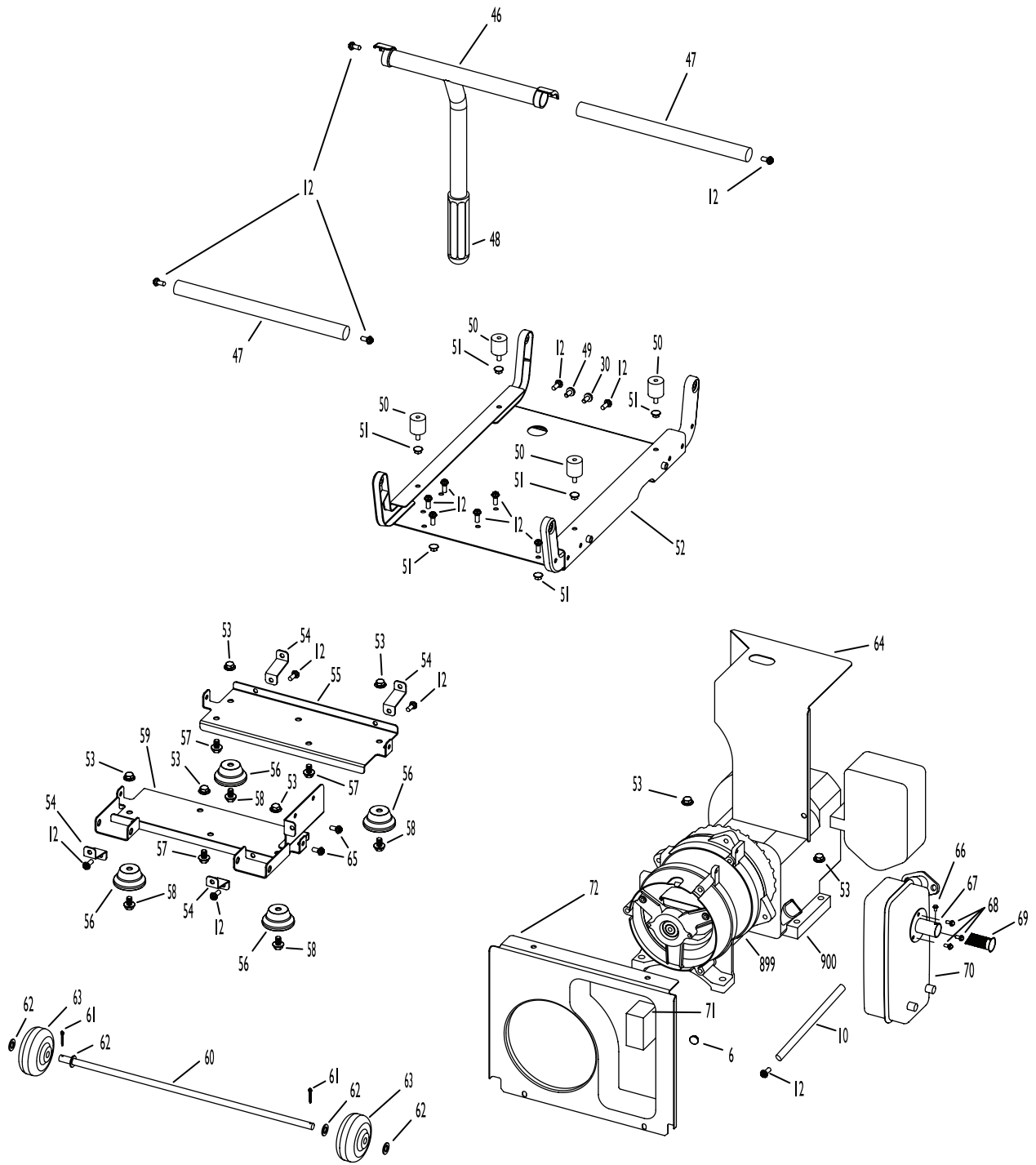

Parts List - Main Unit

Item	Part #	Description	Item	Part #	Description
1	187757GS	BOLT, COVER, MUFFLER	43	187579GS	CLIP, HOSE
2	197871GS	DECAL, ON-OFF	44	197845GS	CLIP, NYLON
3	187450GS	SWITCH, ENG, ON/OFF	45	197844GS	HOSE, FUEL
4	187766GS	DECAL, CHOKE	46	197834GS	HANDLE
5	205088GS	SPACER	47	197835GS	HANDLE, TUBE
6	187761GS	NUT, M4, FLANGE	48	197867GS	GRIP, HANDLE
7	187760GS	SCREW, M4X12	49	197862GS	SCREW
8	197797GS	DECAL, FUEL SHUTOFF, CCW	50	197838GS	MOUNT, VIBRATION, TANK
9	205086GS	PANEL, END, RECOIL	51	197861GS	NUT, M6, FLANGE
10	205092GS	HOSE, DRAIN	52	200231GS	ASSY, HEATSHIELD, TANK
11	205085GS	PANEL, SIDE, MUFFLER	53	187401GS	NUT, M8, FLANGE
12	197860GS	BOLT, M6X16	54	197848GS	BRACKET, PANEL
13	205097GS	DECAL, FUEL	55	197846GS	BASE, ENG
14	196830GS	DECAL, EXHAUST WARNING	56	197851GS	MOUNT, VIBRATION
15	204947GS	PANEL, END, CONTROL	57	197857GS	BOLT, M8X35, FLANGE
16	197881GS	U-PACKING	58	197858GS	BOLT, M8X16, FLANGE
17	187763GS	DECAL, CAUTION, OIL	59	200230GS	ASSY, BASE, ALT
18	203859GS	DECAL, UNIT	60	197852GS	AXLE
19	205084GS	PANEL, SIDE, OIL	61	197869GS	PIN
20	187876GS	CABLE, BATTERY CHARGE, ACC PLUG	62	197868GS	WASHER, FLAT
21	187460GS	BRKR, CRCT, 10A, 125V	63	197853GS	WHEEL
22	197873GS	DECAL, DC OUT	64	205090GS	HEATSHIELD, MUFFLER
23	197875GS	CONNECTOR	65	205082GS	BOLT, M6 - 12, FLANGE
24	197876GS	CONNECTOR	66	197880GS	SCREW, M3-8, SLFTAP
25	187873GS	OUTLET, 12V DC, ACCSSRY	67	197878GS	PIPE, TAIL
26	187415GS	PHMS, M5-0.8 X 20	68	197879GS	SCREW, M4X16
27	197874GS	WASHER, LOCK, INTRNL	69	197877GS	ARRSTR, SPARK
28	187423GS	NUT, M5 X 0.8	70	197842GS	MUFFLER
29	187424GS	NUT, WING, M5 X 0.8	71	205083GS	CONDENSER, 350V
30	197863GS	SCREW, M4X12, SLFTAP	72	197841GS	HTSHLD, ALT
31	197854GS	PANEL, CONTROL	73	191775GS	DECAL, INSTRUCTION
32	197855GS	BRKR, CRCT, 15A, 125V	74	197310GS	DECAL, WARNING FUEL FILL
33	187456GS	RCPTCL, 15 A, 125 V	75	202997GS	DECAL, WARNING, CO
34	187436GS	CAP, FUEL	76	205087GS	SCREW, SELF TAP, M5 - 20
35	197883GS	PACKING, TANK	77	205089GS	WASHER
36	187438GS	STRAINER, FUEL	899	NSP	ALTERNATOR (See page 5)
37	197864GS	BOLT, M6X20, FLANGE	900	§	ENGINE
38	197866GS	WASHER, FLAT			
39	197865GS	SLEEVE			
40	197832GS	TANK, FUEL			
41	187440GS	FILTER, FUEL			
42	187443GS	VALVE, FUEL			

Parts Not Illustrated

203861GS	MANUAL, OPERATOR'S
BB3061BGS	BOTTLE, OIL

§ -Contact Engine Manufacturer

Exploded View and Parts List - Alternator

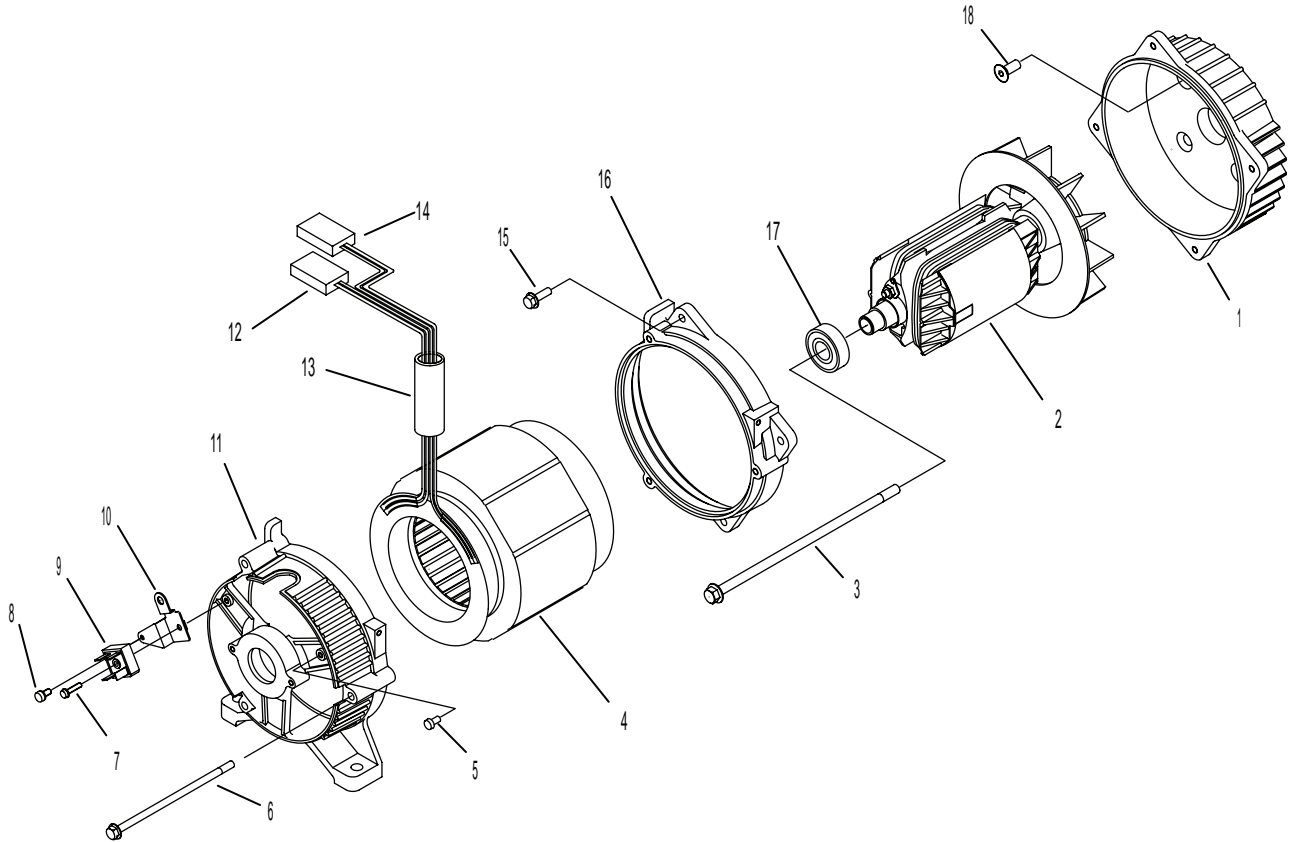

Item	Part #	Description	Item	Part #	Description
1	NSP	ADPTR, ENG	10	NSP	BRACKET, RECTIFIER
2	197890GS	ASSY, ROTOR	11	NSP	RBC
3	NSP	BOLT, ROTOR	12	197899GS	CONNECTOR
4	197892GS	ASSY, STATOR	13	197900GS	SLEEVE
5	NSP	SCREW, M5 X 7	14	197901GS	CONNECTOR
6	197894GS	BOLT, STATOR	15	197864GS	SCREW, M6 X 20
7	197895GS	SCREW, M4 X 18	16	NSP	ADPTR, MNTNG, ALT
8	197896GS	SCREW, M5 X 10	17	187411GS	BEARING
9	187462GS	RECTIFIER	18	197904GS	SCREW, M8 X 20