



Ⓞ Operator's manual & spare parts list.

It is the owner's responsibility to ensure that all operators of this machine have read and understood the content of this manual before using the product! Careless or improper use of this machine can cause serious or even fatal injury! Allow only competent adults to operate this machine!

**K 750
SpeedMill**

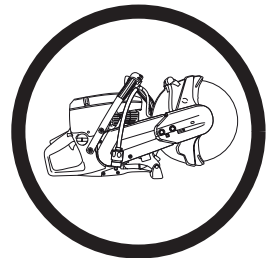

TABLE OF CONTENTS

Section	Page No.	Section	Page No.
Table of Contents.....	2	Uses.....	7
Contact Information.....	2	Tools.....	7
Symbols.....	3	Assembly.....	7 - 8
Introduction.....	4	Operation.....	7 - 8
Safety Instructions.....	4 - 5	Maintenance.....	10
What-Is-What (Part Identification).....	6	Spare Parts.....	10 - 11

CONTACT INFORMATION

Husqvarna Construction Products, North America

Corporate Office
17400 West 119th Street, Olathe, Kansas 66061 USA
Corporate Office: 913-928-1000
Corp. Office Fax: 913-438-7951
www.husqvarnacp.com

For local service, please contact your local Husqvarna Construction Products representative.
Para efectuar un servicio local, póngase en contacto con su representante local de
Husqvarna Construction Products.

Pour toute réparation, contacter le représentant local de Husqvarna Construction Products.
Für Service vor Ort wenden Sie sich bitte an Ihren örtlichen Vertreter von
Husqvarna Construction Products.

Neem voor plaatselijke service contact op met uw plaatselijke vertegenwoordiger van de constructie-
producten van Husqvarna.

Per assistenza, rivolgersi al rappresentante di zona della Husqvarna Construction Products.
För service på platsen, kontakta din lokala representant för Husqvarna Construction Products.
Para obter serviço técnico local, contactar o representante da Husqvarna Construction Products

Husqvarna Construction Products, North America
17400 West 119th Street, Olathe, Kansas 66061 USA
Toll-Free Telephone: 800-288-5040, Telephone: 913-928-1300, Fax: 913-438-7938

SAFETY SYMBOLS & DECALS

Key to symbols

WARNING! The machine can be a dangerous tool if used incorrectly or carelessly, which can cause serious or fatal injury to the operator or others.



Operator must wear head protection such as a hard hat!



Please read the operator's manual carefully and make sure you understand the instructions before using the machine.



Operator must wear protective footwear such as safety shoes or safety boots!



Always wear:

- Protective helmet
- Hearing protection
- Protective goggles or a visor



The operator must wear protective clothing appropriate to the work he is doing. Never wear loose clothing or jewelry. Keep long hair tied back. Keep your hair, clothing, and gloves away from the rotating tool!



WARNING! Dust forms when cutting, this can cause injuries if inhaled. Use an approved breathing mask. Avoid inhaling petrol fumes and exhaust fumes. Always provide for good ventilation.



The working area must be completely clear, well lit and all safety hazards removed.



WARNING! Sparks from the cutting blade can cause fire in combustible materials such as: petrol (gas), wood, dry grass etc.



Any persons not involved in the work, should leave the area.



Operator must wear eye protection!



Operator must wear hearing protection!



Operator must wear respiratory protection!
(Reference OSHA 29CFR 1910.95, 1910.133-138)



FOR INFORMATION ON DECALS FOR THE SPEEDMILL, SEE THE SPARE PARTS LIST SECTION OF THIS DOCUMENT.

FOR INFORMATION ON DECALS FOR THE K 750 POWER CUTTER, SEE THE SPARE PARTS LIST FOR THE K 750.

SAFETY INSTRUCTIONS

Introduction

Thank you for purchasing your new machine from Husqvarna Construction Products. We have provided important safety messages in this manual and on the machine.

Please read these messages carefully. A safety message alerts you to potential hazards that could hurt you or others. Each safety message is preceded by a symbol or the safety alert symbol () and one of two words, **WARNING**, or **CAUTION**.

These signal words mean:

WARNING: Indicates a hazardous situation which, if not avoided **COULD** result in death or serious injury.

CAUTION: Indicates a hazardous situation, which, if not avoided, **COULD** result in minor or moderate injury. It may also be used to alert against unsafe practices. Each message tells you what the hazard is, what can happen, and what you can do to avoid or reduce injury.

NOTICE: Indicates a hazardous situation which, if not avoided, **COULD** result in property damage. Your machine or other property can be damaged if you don't follow this instruction.

If the label is worn, damaged, or is illegible, it should be replaced.



Contents of Package

Verify the contents of the package:

- SpeedMill Power Cutter.
- SpeedMill Bowl Assembly: 100mm (4"), 150mm (6"), and 200mm (8") Bowls with Hub and 2.00" Nut.
- Document Package. Operation Manual for Power Cutter, Spare Parts List for Power Cutter, Operation Manual / Spare Parts List for Speed Mill Accessory (This Document).

If these items are not included in the package, contact our customer service department at the telephone number shown in this document.

Safety Instructions:

 WARNING!	
	Before starting up machine make sure you completely read these instructions and the power cutter operation manual. Be familiar with operation of the machine before operation!
	Your SpeedMill comes with two Operator's Manual's. This one for the SpeedMill attachment and one for the K750 power head. It is the owner's responsibility to ensure that all operators of this SpeedMill have read and understood the content of both manuals before using the product.

 WARNING!	
NEVER use a SpeedMill as a standard power cutter. A SpeedMill is ONLY for USES listed in this document.	
Cut only PVC plastic pipe with a machine equipped with a SpeedMill Accessory! DO NOT cut other materials.	
Use ONLY High Speed Reinforced Abrasive Blades with this machine.	
DO NOT use carbide tipped, wood cutting, or circular saw blades with this machine.	
DO NOT use diamond or rescue blades with this machine! Cutting plastics with a diamond or rescue blade can cause kickback. The heat produced melts the material and it sticks to the blade.	
DO NOT cut ductile iron pipe with a SpeedMill.	
DO NOT touch Bowl when machine is running. Speed-Mill Bowl Rotates with Blade.	
Before performing any maintenance, ALWAYS locate the machine on a level surface with the engine / motor OFF and the start switch in the OFF position, and the power source disconnected.	
EVACUATE PIPE CONTENTS before cutting; else EXPLOSION may occur. Static electricity from the cutting operation may cause sewer or other gas within the pipe to explode.	

	The working area must be completely clear, well lit and all safety hazards removed.
---	--

	Any persons not involved in the work, should leave the area.
---	---

SAFETY INSTRUCTIONS

WARNING!

Read, understand, and follow all warnings and instructions in this and the K750 manuals. Failure to do so may result in serious personal injury as well as damage to the equipment. It is not possible to cover all possible risk situations that can arise in conjunction with pipe cutting and beveling within these instructions. Use common sense and caution at all times.

Remember: "If you don't know – don't do."

The SpeedMill may not be modified from its original design without the manufacturer's approval in writing. Unapproved modifications can result in serious injury.

All operators must be trained in the proper use of this machine. It is the owner's responsibility to explain the content of this manual to all operators and ensure that they receive the necessary training to safely operate this machine.

PERSONAL SAFETY

Stay alert; watch what you are doing, and use common sense when operating this SpeedMill or any other power tool. Do not use when tired or under the influence of drugs, alcohol, or medication, or any substance that could affect your judgment. A moment of inattention during operation may result in serious personal injury.

Keep proper footing and balance at all times. Do not overreach or operate from a ladder. Do not operate above chest height. If necessary use proper scaffolding to reach a safe operating height.

Use personal safety equipment. Always wear eye protection, hard hat, hearing protection, non-slip safety shoes and gloves. Respirator mask must be used when dry-cutting. (Reference OSHA 29CFR 1910.95, 1910.133-138)

Dress properly. Never wear loose clothing or jewelry. Keep long hair tied back. Keep your hair, clothing, and gloves away from the rotating blade.



Do not use the SpeedMill if the ON/OFF switch does not turn it on or off. Have the switch replaced before the SpeedMill is used again.

WORK AREA SAFETY

Keep the work area organized. Maintain a firm grip of the SpeedMill and have a proper footing and balance at all times.



Do not operate your SpeedMill in an explosive atmosphere. Sparks may ignite flammable liquids, gases, or dust. This is a concern when old pipes are being repaired.

Keep all bystanders at a safe distance. Bystanders can be a distraction that can cause you to lose control.

CHOICE OF BLADE

Use only 12" high speed abrasive concrete cutting blades for cutting specified PVC pipe with the SpeedMill.

Use only blades designated **High Speed** blades with a minimum speed rating of 6300 rpm. Many blades are not made for hand held high speed saw and they all have a lower speed rating (marked on their label) Such blades might brake at higher speed with possible severe injury as a result.

Diamond blades shall not be used while cutting any plastic pipe due to the increased risk of "kick-back". (Regarding kick-back see K750 operation manual).

Use of carbide tipped blades or any blade with cutting teeth, is a violation of OSHA regulations and shall never be used.

WHAT IS WHAT

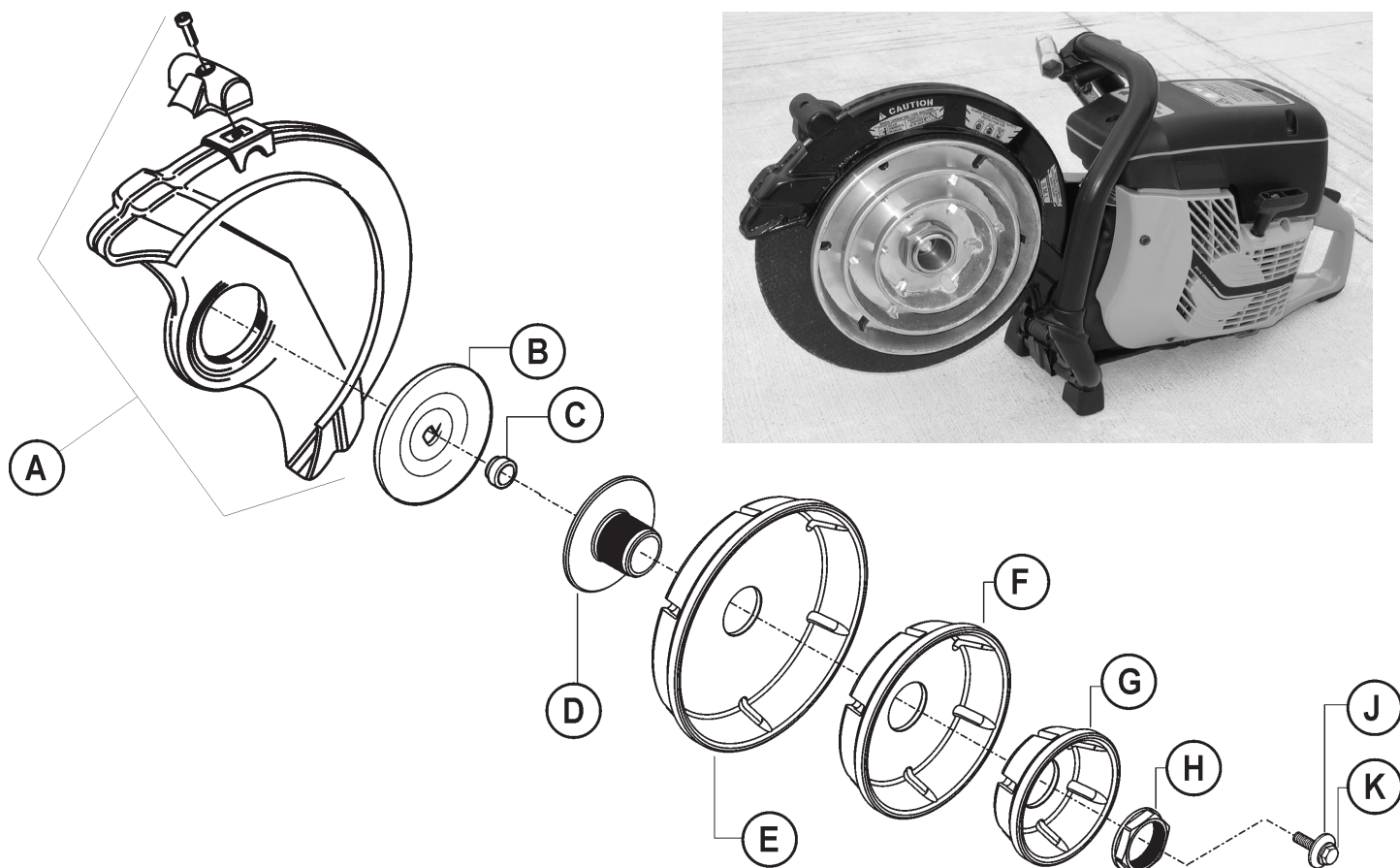

WHAT IS WHAT (PARTS IDENTIFICATION)

A. SpeedMill BLADE GUARD: Designed specifically for the SpeedMill. One side is open to allow mounting of the SpeedMill Bowls. Read this Operation Manual for more information. See SpeedMill Spare Parts List in this document for part number.

B. Inner Flange: Used to support Abrasive Blade. See K750 power cutter Operation Manual for additional instructions on this item.

C. Blade Arbor Spacer: Used to support Abrasive Blade. See K750 power cutter Operation Manual for additional instructions on this item.

D. SpeedMill Hub: Designed specifically for the SpeedMill. Acts as an outer flange for the Abrasive Blade, and a mounting arbor for the SpeedMill Bowls (E, F, G). Read this Operation Manual for more information. See SpeedMill Spare Parts List in this document for part number.

E. 200mm (8") SpeedMill Bowl: Designed specifically for the SpeedMill. **Always install 8" (200mm) Speed-Mill Bowl before using machine!** Use for beveling 8" (200mm) plastic pipe. Read this Operation Manual for more information. See SpeedMill Spare Parts List in this document for part number.

F. 150mm (6") SpeedMill Bowl: Designed specifically for the SpeedMill. Use for beveling 6" (150mm) plastic pipe. Read this Operation Manual for more information. See SpeedMill Spare Parts List in this document for part number.

G. 100mm (4") SpeedMill Bowl: Designed specifically for the SpeedMill. Use for beveling 4" (100mm) plastic pipe. Read this Operation Manual for more information. See SpeedMill Spare Parts List in this document for part number.

H. SpeedMill Hub Nut: Designed specifically for the SpeedMill. Holds SpeedMill Bowls (E, F, G) in position. Read this Operation Manual for more information. See SpeedMill Spare Parts List in this document for part number.

J. Arbor Bolt Washer: Used to hold SpeedMill Hub (D) in position. See K750 power cutter Operation Manual for additional instructions on this item.

K. Arbor Bolt: Used to hold SpeedMill Hub (D) in position. See K750 power cutter Operation Manual for additional instructions on this item.

Note: See K750 Power Cutter Operation Manual, and K750 Spare Parts List for information on any other parts of this machine. High Speed Abrasive Blade Not Included.

USES, TOOLS, AND ASSEMBLY

Uses: Cutting and beveling of 100mm (4"), 150mm (6"), and 200mm (8") PVC pipe of the following types; ASTM D2241 IPS Gasketed Pipe, and ASTM D3034 Gravity Sewer Pipe (Type SDR 35, and SDR 26). Note that this machine, as supplied, is not designed for cutting AWWA C900 Municipal Water Pipe, or any non-plastic material.

⚠ WARNING!

ONLY CUT or BEVEL PVC plastic pipe with a machine equipped with a Speed Mill Accessory!

DO NOT cut other materials with this machine!

DO NOT cut or bevel ductile iron pipe with a machine equipped with a Speed Mill Accessory!

DO NOT use machine as a standard power cutter without proper power cutter blade guard.

Tools: 12" (305mm) Diameter Abrasive Blade, with a 1" (25.4mm) arbor (Not Included).

⚠ WARNING!

Use ONLY High Speed Reinforced Abrasive Blades with a minimum speed rating of 6300 rpm.

DO NOT use carbide tipped, wood cutting, or circular saw blades with this machine!

First Time Assembly:

Tools Required:

- Screwdriver (for Arbor Lock)(Not Included).
- 2" (50.8mm) Socket, and Socket Wrench (Not Included).
- Combination Spanner (supplied with machine).
- Torque Wrench.



Unwrap SpeedMill bowl / Hub Assembly from the packaging. Initially all three sizes of Speed-Mill Bowls (4", 6", 8") are assembled to the Hub Assembly.

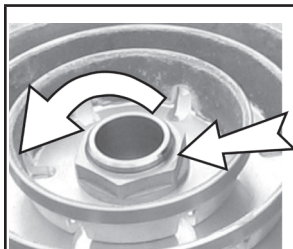

Change the mounted bowl sizes if desired. Turn the 2" (50.8mm) hub nut Counter-Clockwise to remove. Lift off the smaller bowls, and configure the bowl / hub assembly as desired. Example: 6" and 8" bowl combination is popular. ALWAYS mount the 8" bowl, it may shield operator in case of blade breakage.

⚠ CAUTION!

Always install the 8" SpeedMill Bowl (P/N 542 19 61-89) before using the machine! The 8" SpeedMill must always be installed even if the machine will only be used to cut and bevel smaller diameter pipes. Besides serving as a beveller for 8" pipes the 8" flange is also designed to cover the area between the guard and the blade and to prevent unintentional contact with the blade.

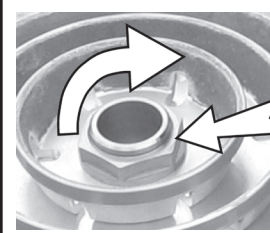

Install and Re-tighten the 2" (50.8mm) hub nut. Torque to 130-215 in-lbs. (15-25 Nm). NOTE: Do not tighten excessively – nut will tighten during cutting process – making dis-assembly difficult.



Loosen and remove the blade shaft screw & washer from the power cutter. Use the combination spanner supplied, and a Screwdriver to lock the blade shaft in position, if required.

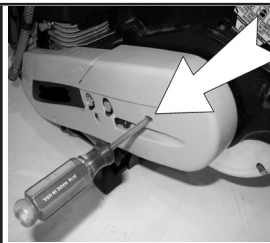

Use a Screwdriver to lock the blade shaft in position. Push the screwdriver into the slot (see picture) and rotate the arbor until the screwdriver stops the rotation.

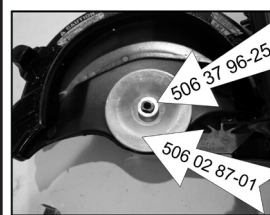

Verify that 1" (25.4mm) adapter (P/N 506 37 96-25) is pushed onto blade shaft so it contacts the inner flange. The mounting surfaces of the flange and bushing arbor must be undamaged, clean, and free of debris. Verify that the flange (P/N 506 02 87-01) has a diameter of 4.13" (105mm).

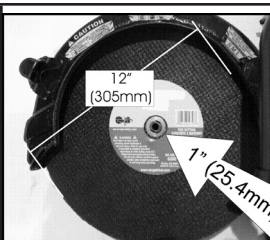

Mount a 12" (305mm) diameter, 1" (25.4mm) arbor High Speed Reinforced Abrasive Blade (not included) on the blade shaft.

ASSEMBLY AND OPERATION

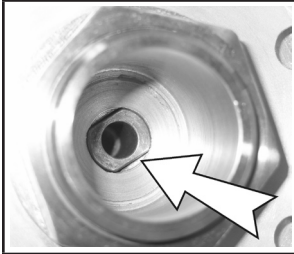

Mount the SpeedMill Bowl Assembly. Align the slot in the SpeedMill Hub with the face of the shaft. Make sure the flange face of the SpeedMill Hub contacts the face of the blade.



Install the blade shaft bolt into the Hub Assembly.

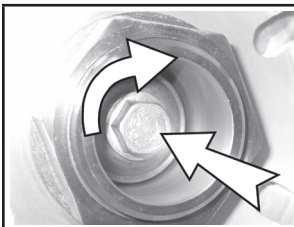

Using Combination Spanner, Supplied with machine, tighten blade shaft bolt by turning it clockwise. Torque to 130-215 in-lbs. (15-25 Nm).



Before using the assembled machine, completely read the power cutter operation manual supplied with this machine.

OPERATION:

WARNING!



Before starting up machine make sure you completely read these instructions and the power cutter operation manual. Be familiar with operation of the machine before operation!



WARNING!

EVACUATE PIPE CONTENTS before cutting; else **EXPLOSION** may occur! Static electricity from cutting operation may cause gas or other pipe contents to explode (for installed piping).

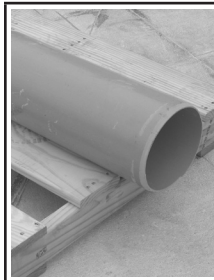

Position plastic pipe so pipe end is off the ground. Secure pipe in place if required. Example: Set plastic pipe between two of the boards of a wooden pallet.

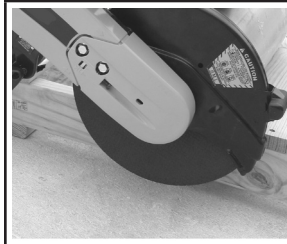

Before starting machine, verify that when SpeedMill Bowl and blade is positioned to cut / bevel the plastic pipe, that it clears all objects in the cutting area.



Start machine per instructions in K750 Power Cutter Operation Manual.

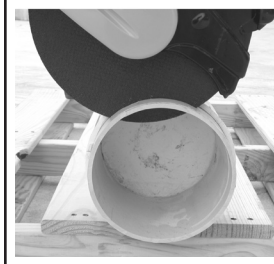

Position machine at top of plastic pipe to begin cutting through the pipe wall.

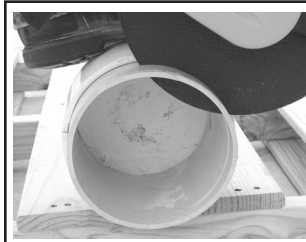

Move saw forward while maintaining a "square cut" on the end of the pipe. This means the cut should always be perpendicular to the length of the pipe.

OPERATION

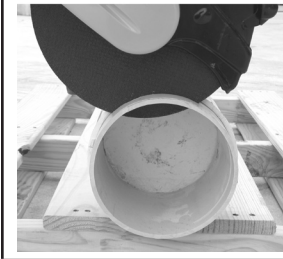

Rotate Pipe and repeat this cutting process until pipe circumference is cut.



Align proper SpeedMill Bowl with end of pipe, and move toward the pipe so that the pipe is slightly beveled.
Note: The bevel required is usually quite small, so do not remove excessive pipe material.



Bevel Pipe: Position SpeedMill Bowl near end of pipe to be beveled. Accelerate power cutter to full throttle.

WARNING!

HOLD MACHINE ONLY at front and rear handles!

NEVER bevel or cut material while holding the pipe with your hands!

DO NOT use blade guard pivot handle as a hand hold while operating machine!



HOLD MACHINE ONLY at front and rear handles, as shown in the above photo.

MAINTENANCE

MAINTENANCE:

CAUTION!

Allow SpeedMill Bowls to cool before performing any maintenance.

NOTICE!

DO NOT hold SpeedMill Bowls using a screwdriver or other device through the slots in the bowl. Damage to the bowls or abrasive coating could occur.

DO NOT use a screw driver or similar in the slots of the SpeedMill Bowls to lock the blade. If you do it is likely the flanges will be damaged and become unusable.

Use the proper procedure to lock the blade when attaching or removing the blade or flanges – See below, or see K750 Operation Manual.

CONVERTING THE SPEEDMILL TO A REGULAR POWER CUTTER.

The guard on the SpeedMill is designed to work together with the special outer flange and SpeedMill Bowls used on the SpeedMill. The 8" (200mm) SpeedMill Bowl must always be installed when the SpeedMill is used and the SpeedMill shall not be used for any other purpose than those mentioned in "USES" section of this document. Should you desire to convert the SpeedMill to a regular power cutter you must replace the cutting head with an original 12" or 14" cutting head attachment. We recommend you have an authorized dealer do the conversion.

WARNING!

NEVER use the SpeedMill as a regular power cutter!

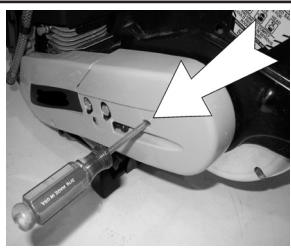

When removing the Hub nut, use a Screwdriver to lock the blade shaft in position. Push the screwdriver into the slot (see picture) and rotate the arbor until the screwdriver stops the rotation.

Inspect the SpeedMill Bowls

Always inspect the SpeedMill Bowls before you start cutting. Small nicks or scratches can be sanded smooth. If the SpeedMill Bowl has been bent or distorted in any way it must be replaced.

Cleaning



Plastic debris from a smaller flange often lodges itself in the bigger flange during cutting. This can easily be removed once the flanges have cooled down.

Use compressed air to blow shavings from SpeedMill Bowl. DO NOT scrap shavings from bowl using a screwdriver or any other hard metallic tool. Damage to the bowls or abrasive coating could occur.

SPARE PARTS:

The parts required for the SpeedMill Accessory are shown on the next page. For any other parts used on this machine see the power cutter spare parts list (included).

SPARE PARTS

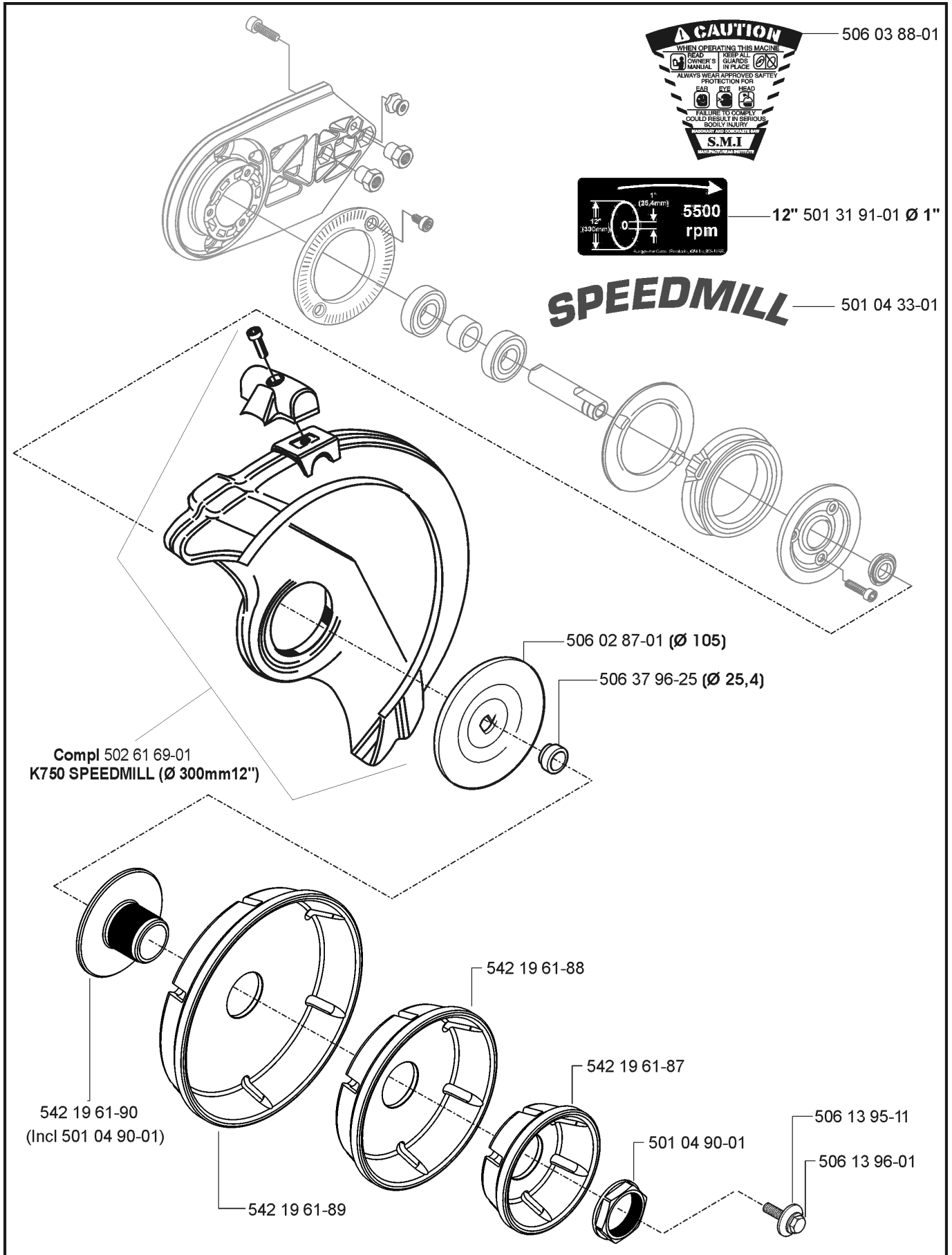



www.husqvarnacp.com

115 07 95-27