

Operator's manual (EPA)

K750

Please read the operator's manual carefully and make sure you understand the instructions before using the machine.

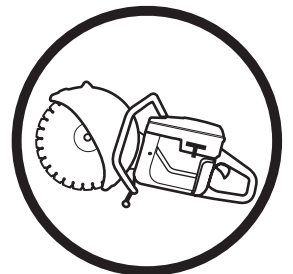

English

KEY TO SYMBOLS

Key to symbols

WARNING! The machine can be a dangerous tool if used incorrectly or carelessly, which can cause serious or fatal injury to the operator or others.



Please read the operator's manual carefully and make sure you understand the instructions before using the machine.



Always wear:

- Protective helmet
- Hearing protection
- Protective goggles or a visor
- Breathing mask



WARNING! Dust forms when cutting, this can cause injuries if inhaled. Use an approved breathing mask. Avoid inhaling petrol fumes and exhaust fumes. Always provide for good ventilation.



WARNING! Sparks from the cutting blade can cause fire in combustible materials such as: petrol (gas), wood, dry grass etc.



Switch off the engine by moving the stop switch to the STOP position before carrying out any checks or maintenance.



Always wear protective gloves.

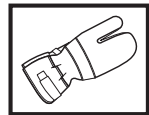

Regular cleaning is required.

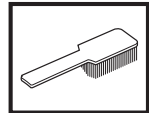

Visual check.



Protective goggles or a visor must be worn.



Run position.



Stop, with the return spring to the operating position.



Stop, in the fixed position.

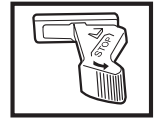

Other symbols/decals on the machine refer to special certification requirements for certain markets.

CONTENTS

Contents

KEY TO SYMBOLS

Key to symbols	2
----------------------	---

CONTENTS

Contents	3
----------------	---

WHAT IS WHAT?

What is what on the power cutter?	4
---	---

SAFETY INSTRUCTIONS

Steps before using a new power cutter.	5
Personal protective equipment	5
Machine's safety equipment	6
Checking, maintaining and servicing the machine's safety equipment	7
General safety precautions	8
General working instructions	9
Cutting blades	11

ASSEMBLY

Checking the drive axle and flange washers	13
Fitting the cutting blade	13
Guard for the blade	13

FUEL HANDLING

Fuel	14
K750	14
K750 OilGuard	14
Fueling	15

STARTING AND STOPPING

Starting and stopping	16
-----------------------------	----

MAINTENANCE

Tensioning the drive belt	17
Replacing the drive belt	17
Belt pulley and clutch	17
Carburetor	17
Fuel filter	18
Air filter	18
Starter	19
Spark plug	20
Cooling system	20
Muffler	20
General maintenance instructions	21

TECHNICAL DATA

Technical data	22
Cutting equipment	22

FEDERAL EMISSION CONTROL WARRANTY STATEMENT

YOUR WARRANTY RIGHTS AND OBLIGATIONS	23
--	----

WHAT IS WHAT?

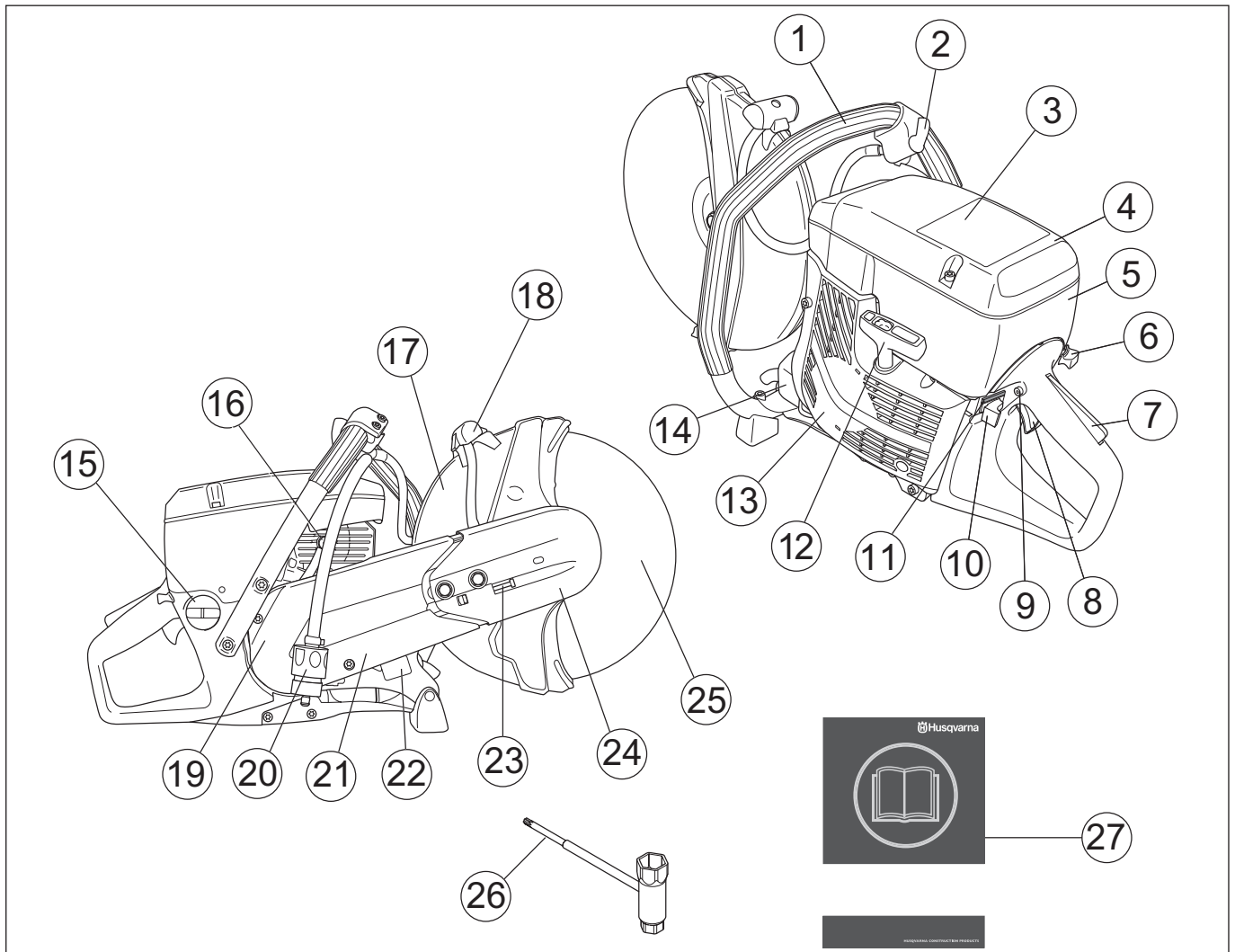

What is what on the power cutter?

- | | |
|--|---------------------------------|
| 1 Front handle | 15 Fuel tank |
| 2 Water tap | 16 Decompression valve |
| 3 Warning decal | 17 Guard for the blade |
| 4 Air filter cover | 18 Adjustment handle for guard |
| 5 Cylinder cover | 19 Belt guard |
| 6 Choke | 20 Water connection with filter |
| 7 Throttle lockout | 21 Cutting arm |
| 8 Throttle control | 22 Type plate |
| 9 Start throttle lock | 23 Belt tensioner |
| 10 Stop switch | 24 Cutting head |
| 11 Disconnection function for OilGuard (K750 OilGuard) | 25 Cutting blade |
| 12 Starter handle | 26 Combination spanner |
| 13 Starter | 27 Operator's manual (EPA) |
| 14 Muffler | |

SAFETY INSTRUCTIONS

Steps before using a new power cutter

- Please read the operator's manual carefully.
- Check the cutting blade's mounting, see the chapter "Assembly".
- Start the engine and check the idling setting, see instructions under the heading Maintenance. When the carburettor is set correctly the cutting blade should be still while idling. Setting of the idle speed is described in the Operator's Manual. Set the correct speed according to these instructions. Do not use the power cutter if the idle speed is not adjusted correctly!
- Let your Husqvarna dealer regularly check the power cutter and make essential adjustments and repairs.



WARNING! Under no circumstances may the design of the machine be modified without the permission of the manufacturer. Always use genuine accessories. Non-authorized modifications and/or accessories can result in serious personal injury or the death of the operator or others.



WARNING! Use of products which cut, grind, drill, sand or shape material can generate dust and vapors which may contain harmful chemicals. Know the nature of the material being worked on and wear appropriate dust mask or respirator protection.



WARNING! A power cutter is a dangerous tool if used carelessly or incorrectly and can cause serious, even fatal injuries. It is extremely important that you read and understand the contents of this Operator's Manual.



WARNING! The ignition system of this machine produces an electromagnetic field during operation. This field may under some circumstances interfere with pacemakers. To reduce the risk of serious or fatal injury, we recommend persons with pacemakers to consult their physician and the pacemaker manufacturer before operating this machine.



WARNING! Some dust created by power sanding, sawing, grinding, drilling, and other construction activities contains chemicals known (to the State of California) to cause cancer, birth defects or other reproductive harm. Some examples of these chemicals are:

Lead from lead-based paints.

Crystalline silica from bricks, cement and other masonry products.

Arsenic and chromium from chemically treated lumber.

Your risk from these exposures varies, depending on how often you do this type of work. To reduce your exposure to these chemicals: work in a well ventilated area, and work with approved safety equipment, such as those dust masks that are specially designed to filter out microscopic material.



WARNING

The engine exhaust from this product contains chemicals known to the State of California to cause cancer, birth defects or other reproductive harm.

You will find the following labels on your power cutter:



The Emissions Compliance Period referred to on the Emission Compliance label indicates the number of operating hours for which the engine has been shown to meet Federal emissions requirements. Category C = 50 hours, B = 125 hours, and A = 300 hours.

Husqvarna Construction Products has a policy of continuous product development. Husqvarna reserves the right to modify the design and appearance of products without prior notice and without further obligation introduce design modifications.

All information and all data in the Operator's Manual were applicable at the time the Operator's Manual was sent to print.

Personal protective equipment



WARNING! You must use approved personal protective equipment whenever you use the machine. Personal protective equipment cannot eliminate the risk of injury but it will reduce the degree of injury if an accident does happen. Ask your dealer for help in choosing the right equipment.

- Protective helmet
- Hearing protection
- Protective goggles or a visor

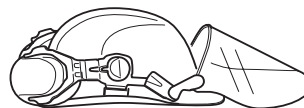

- Breathing mask

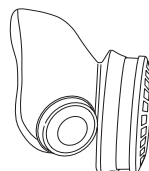

SAFETY INSTRUCTIONS

- Heavy-duty, firm grip gloves.

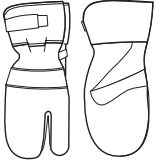

- Tight-fitting, heavy-duty and comfortable clothing that permits full freedom of movement.

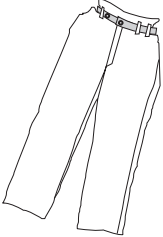

- Use leg-guards recommended for the material to be cut.
- Boots with steel toe-caps and non-slip sole



- Always have a first aid kit nearby.

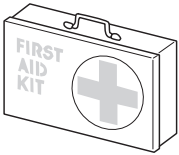

Machine's safety equipment

This section describes the machine's safety equipment, its purpose, and how checks and maintenance should be carried out to ensure that it operates correctly. See the "What is what?" section to locate where this equipment is positioned on your machine.



WARNING! Never use a machine that has faulty safety equipment! Carry out the inspection, maintenance and service routines listed in this section.

Vibration damping system

Your machine is equipped with a vibration damping system that is designed to reduce vibration and make operation easier.

The machine's vibration damping system reduces the transfer of vibration between the engine unit/cutting equipment and the machine's handle unit.

The engine body, including the cutting equipment, is insulated from the handles by vibration damping units.

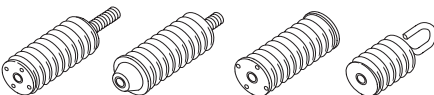

Stop switch

Use the stop switch to switch off the engine.

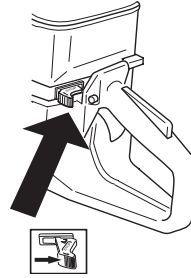

Muffler



WARNING! The muffler gets very hot in use and remains so for a short time afterwards. Do not touch the muffler if it is hot!

The muffler is designed to keep noise levels to a minimum and to direct exhaust fumes away from the user.



WARNING! The exhaust fumes from the engine are hot and may contain sparks which can start a fire. Never start the machine indoors or near combustible material!

IMPORTANT INFORMATION

For mufflers it is very important that you follow the instructions on checking, maintaining and servicing your machine. See instructions under the heading Checking, maintaining and servicing the machine's safety equipment.



WARNING! The inside of the muffler contain chemicals that may be carcinogenic. Avoid contact with these elements in the event of a damaged muffler.

Throttle lockout

The throttle trigger lock is designed to prevent accidental operation of the throttle. When the lock (A) is pressed in this releases the throttle (B).

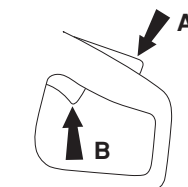

The trigger lock remains pressed in as long as the throttle is pressed. When the grip on the handle is released the throttle trigger and the throttle trigger lock both return to their original

SAFETY INSTRUCTIONS

positions. This is controlled by two independent return spring systems. This means that the throttle trigger is automatically locked in the idle position.

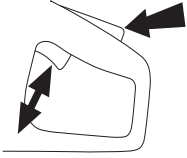

Guard for the blade



This guard is fitted above the cutting blade and is designed to prevent parts of the blade or cutting fragments from being thrown towards the user.

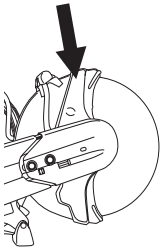

Checking, maintaining and servicing the machine's safety equipment



WARNING! All servicing and repair work on the machine requires special training. This is especially true of the machine's safety equipment. If your machine fails any of the checks described below you must contact your service agent. When you buy any of our products we guarantee the availability of professional repairs and service. If the retailer who sells your machine is not a servicing dealer, ask him for the address of your nearest service agent.

Vibration damping system

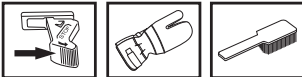

Regularly check the vibration damping units for cracks or deformation.

Make sure the vibration damping units are securely attached to the engine unit and handle unit.

Keep the handles clean and dry.

Stop switch

Start the engine and make sure the engine stops when you move the stop switch to the stop setting.

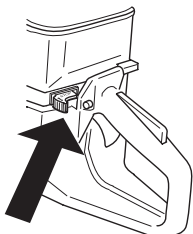

Muffler

Never use a machine that has a faulty muffler.



Regularly check that the muffler is securely attached to the machine.

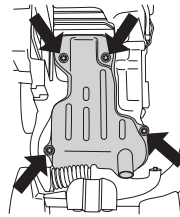

Throttle lockout

- Make sure the throttle control is locked at the idle setting when the throttle lockout is released.

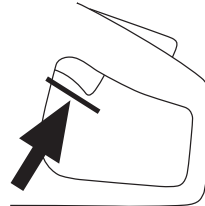

- Press the throttle lockout and make sure it returns to its original position when you release it.

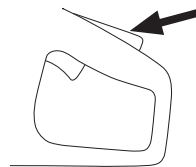

- Check that the throttle control and throttle lockout move freely and that the return springs work properly.

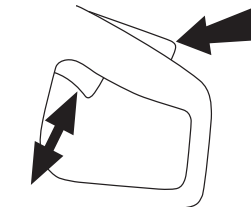

- Start the power cutter and apply full throttle. Release the throttle control and check that the cutting blade stops and remains stationary. If the cutting blade rotates when the throttle is in the idle position you should check the carburettor's idle adjustment.

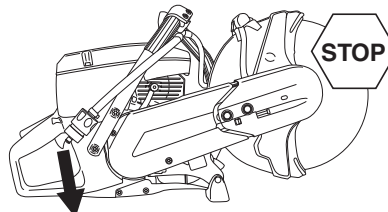

- See instructions under the heading Maintenance.

SAFETY INSTRUCTIONS

Checking the blade guard



WARNING! Always check that the guard is correctly fitted before starting the machine. Check that the cutting blade is fitted correctly and does not show signs of damage. A damaged cutting blade can cause personal injury. See instructions under the heading Assembly.

Check that the guard is complete and without any cracks or deformations.

General safety precautions

- A power cutter is designed to cut hard materials, such as masonry. Observe the increased risk of kickback when cutting soft materials. See instructions under the heading How to avoid kickback.
- Do not use the power cutter until you have read the entire contents of this Operator's Manual. All servicing, in addition to the points listed in the section "Control, maintenance and service of the power cutter's safety equipment", should be carried out by trained service specialists.
- Never use the machine if you are tired, if you have drunk alcohol, or if you are taking medication that could affect your vision, your judgement or your co-ordination.
- Wear personal protective equipment. See instructions under the heading Personal protective equipment.
- Never use a machine that has been modified in any way from its original specification.
- Never use a machine that is faulty. Carry out the checks, maintenance and service instructions described in this manual. Some maintenance and service measures must be carried out by trained and qualified specialists. See instructions under the heading Maintenance.
- Never allow anyone else to use the machine without first ensuring that they have understood the contents of the operator's manual.
- Never use the machine indoors. Be aware of the dangers of inhaling the engine's exhaust fumes.

Transport and storage

Do not store or transport the power cutter with the cutting blade fitted.

Store the power cutter in a lockable area so that it is out of reach of children and unauthorised persons.

All blades should be removed from the cutter after use and stored carefully. Store cutting blades in dry, frost free conditions.

Special care should be taken with abrasive discs. Abrasive discs must be stored on a flat, level surface. If blades are supplied with a backing pad then a spacer should be used to keep them flat. If an abrasive disc is stored in humid conditions, this can cause imbalance and result in injury.

Inspect new blades for transport or storage damage.

Fuel safety



(Refuelling/Fuel mixture/Storage.)



WARNING! Take care when handling fuel. Bear in mind the risk of fire, explosion and inhaling fumes.

- Never refuel the machine while the engine is running.
- Make sure there is plenty of ventilation when refuelling or mixing fuel (gasoline and 2-stroke oil).
- Move the machine at least 10 ft (3 m) from the refuelling point before starting it.

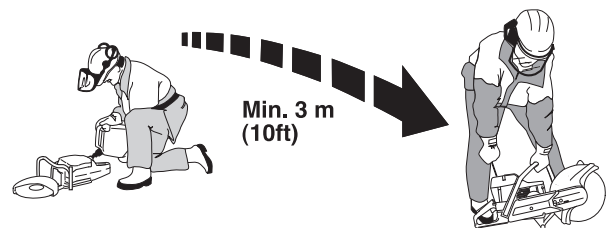

- Never start the machine:
 - If you have spilled fuel on it. Wipe off the spillage and allow remaining fuel to evaporate.
 - If you have spilled fuel on yourself or your clothes, change your clothes. Wash any part of your body that has come in contact with fuel. Use soap and water.
 - If the machine is leaking fuel. Check regularly for leaks from the fuel cap and fuel lines.
- Store and transport the machine and fuel so that there is no risk of any leakage or fumes coming into contact with sparks or naked flames, for example, from electrical machinery, electric motors, electrical relays/switches or boilers.
- Always store fuel in an approved container designed for that purpose.
- When storing the machine for long periods the fuel tank must be emptied. Contact your local gas station to find out where to dispose of excess fuel.
- Always use a Husqvarna fuel container with an anti-spill valve.



WARNING! Bear in mind the risk of fire, explosion and inhaling fumes. Stop the engine before fuelling. Do not fill so that the fuel runs over. Wipe up all spillage on the ground and machine. If you spill fuel on yourself or your clothes. Change your clothes. Move the machine at least 3 metres away from the refuelling area before starting.

SAFETY INSTRUCTIONS

General working instructions



WARNING! This section describes basic safety directions for using a power cutter. This information is never a substitute for professional skills and experience. If you get into a situation where you feel unsafe, stop and seek expert advice. Contact your dealer, service agent or an experienced power cutter user. Do not attempt any task that you feel unsure of!

Basic safety rules

- Look around you:
 - To ensure that people, animals or other things cannot affect your control of the machine.
 - To make sure that none of the above come into contact with the cutting blade.
- Do not use the machine in bad weather, such as dense fog, rain, strong wind, intense cold, etc. Working in bad weather is tiring and can lead to dangerous conditions, e.g. slippery surfaces.
- Never start to work with the power cutter before the working area is clear and you have a firm foothold. Look out for any obstacles with unexpected movement. Ensure when cutting that no material can become loose and fall, causing operating injury. Take great care when working on sloping ground.
- Make sure that no clothes or parts of the body come in contact with the cutting equipment when it is rotating.
- Keep at a safe distance from the cutting equipment when it is rotating.
- The guard for the cutting equipment must always be on when the machine is running.
- Ensure that the working area is sufficiently illuminated to create a safe working environment.
- Do not move the machine when the cutting equipment is rotating. The machine is equipped with a friction retarder to shorten the stop time.
- Always ensure you have a safe and stable working position.
- Make sure that no pipes or electrical cables are routed in the area to be cut.



WARNING! Only use the machine in areas with good ventilation. Neglect can result in serious injury or death.

Cutting



WARNING! The safety distance for the power cutter is 15 metres. You are responsible to ensure that animals and onlookers are not within the working area. Do not start cutting until the working area is clear and you are standing firmly.

General

- Start cutting with the machine running at maximum speed.
- Always hold the machine in a firm grip with both hands. Hold it so that the thumbs and fingers grip round the handles.

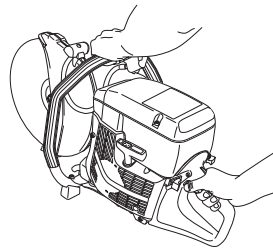

WARNING! Overexposure to vibration can lead to circulatory damage or nerve damage in people who have impaired circulation. Contact your doctor if you experience symptoms of overexposure to vibration. These symptoms include numbness, loss of feeling, tingling, pricking, pain, loss of strength, changes in skin colour or condition. These symptoms normally appear in the fingers, hands or wrists.

Cutting technique

The technique described below is of a general character. Check information for each blade regarding individual cutting characteristics (for example, diamond blades requires less feeding pressure than an abrasive discs).

- Support the work piece in such a way that it is possible to predict what will happen, and so that the cut remains open while cutting.

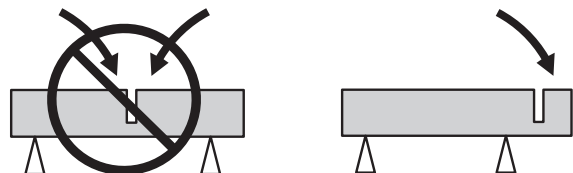

- Check that the blade is not in contact with anything when the machine is started
- Always cut at maximum speed.
- Start cutting smoothly, allowing the machine to work without forcing or pressing in the blade.

SAFETY INSTRUCTIONS

- Move the blade slowly forwards and backwards to achieve a small contact area between the blade and the material to be cut. This reduces the temperature of the blade and ensures effective cutting.

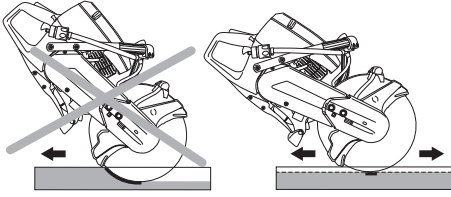

- Feed down the machine in line with the blade. Pressure from the side can damage the blade and is very dangerous.

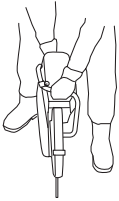

- The guard for the cutting equipment should be adjusted so that the rear section is flush with the work piece. Spatter and sparks from the material being cut are then collected up by the guard and led away from the user.

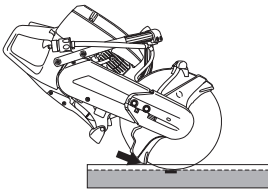

WARNING! Under all circumstances avoid grinding using the side of the blade; it will almost certainly be damaged, break and can cause immense damage. Only use the cutting section.

Do not pull the power cutter to one side, this can cause the blade to jam or break resulting in injury to people.

Sharpening diamond blades

Diamond blades can become dull when the wrong feeding pressure is used or when cutting certain materials such as heavily reinforced concrete. Working with a blunt diamond blade causes overheating, which can result in the diamond segments coming loose.

Sharpen the blade by cutting in a soft material such as sandstone or brick.

Blade vibration

The blade can become out-of-round and vibrate if an excessive feed pressure is used.

A lower feed pressure can stop the vibration. Otherwise replace the blade. The blade must be of the recommended type for the material to be cut.

How to avoid kickback



WARNING! Kickback can happen very suddenly and violently; kicking the power cutter and cutting blade back at the user. If this happens when the cutting blade is moving it can cause very serious, even fatal injuries. It is vital you understand what causes kickback and that you can avoid it by taking care and using the right working technique.

What is kickback?

The word kickback is used to describe the sudden reaction that causes the power cutter and cutting blade to be thrown from an object when the upper quadrant of the blade, known as the kickback zone, touches an object.

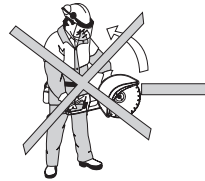

General rules

- Never start to cut with the upper quadrant of the blade as shown in the figure, also known as the kickback zone.

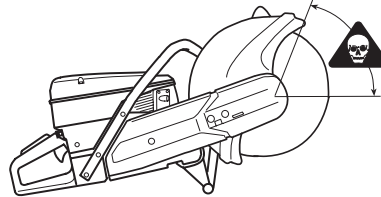

- Always hold the machine in a firm grip with both hands. Hold it so that the thumbs and fingers grip round the handles.

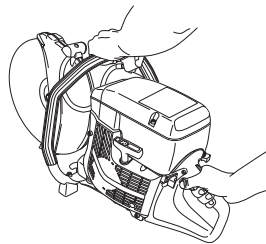

- Keep a good balance and a firm foothold.
- Always cut at maximum speed.
- Stand at a comfortable distance from the work piece.
- Take care when inserting the blade in an existing cut.
- Never cut above shoulder height.
- Be alert to movement of the work piece or anything else that can occur, which could cause the cut to close and pinch the blade.

Pull in

Pull in occurs when the disc's lower section suddenly stops or when the cut closes. (To avoid, see the heading "Basic rules" and "Jamming/rotation", here below.)

SAFETY INSTRUCTIONS

Pinching/rotation

If the cut is pressed together this can lead to jamming. The machine can be pulled down suddenly with a very powerful jerk.

How to avoid pinching

Support the work piece in such a way that the cut remains open during the cutting operation and when the cut is finished.

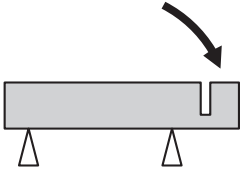

Cutting blades



WARNING! A cutting blade may burst and cause injury to the operator.

Never use a cutting blade at a lower speed rating than that of the power cutter.

Never use a cutting blade for any other purpose than that it was intended for.



WARNING! Cutting plastics with a diamond blade or rescue blade can cause kickback when the material melts due to the heat produced when cutting and sticks to the blade.

General

Cutting blades are available in two basic designs; abrasive discs and diamond blades.

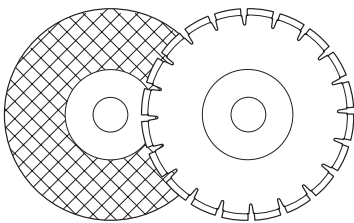

Always remove the cutting blade when the machine is transported.

Make sure that the right bushing is used for the cutting blade to be fitted on the machine. See the instructions under the heading Assembling the cutting blade.

High-quality blades are often most economical. Lower quality blades often have inferior cutting capacity and a shorter service life, which results in a higher cost in relation to the quantity of material that is cut.

Water cooling



WARNING! Water cooling, which is used when cutting concrete, cools the blade and increases its service life while also reducing the formation of dust. Disadvantages include difficulties at very low temperatures, the risk of damaging floors and other structural elements, and the risk of slipping.

After using an abrasive disc with water cooling, run the disc dry for about half a minute. If an abrasive disc is stored in humid conditions, this can cause imbalance and result in injury.

High speed handheld machines

Our cutting blades are manufactured for high-speed, portable power cutters. If blades from other manufacturers are used, ensure that the blades conform to all regulations and demands that concern this type of power cutter.

Special blades

Some cutting blades are designed for stationary equipment and for use with attachments. Such cutting blades must not be used on portable power cutters.

Always contact local authorities and make sure you are following applicable directives.

Abrasive discs

The cutting material on abrasive discs consists of grit bonded using an organic binder. "Reinforced blades" are made up of a fabric or fibre base that prevents total breakage at maximum working speed if the blade should be cracked or damaged.

A cutting blade's performance is determined by the type and size of abrasive corn, and the type and hardness of the bonding agent.

Abrasive discs, types and use		
	Use	
Disc type	Material	Water cooling
Concrete	Concrete, asphalt, stone masonry, cast iron, aluminium, copper, brass, cables, rubber, plastic, etc.	Can be used to reduce dust. Run the disc dry for about a half minute after using an abrasive disc with water cooling.
Metal	Steel, steel alloys and other hard metals.	NOT recommended

Check that the blade is approved for the same or higher speed according to the approval plate of the engine. Never use a cutting blade with a lower speed rating than that of the power cutter.

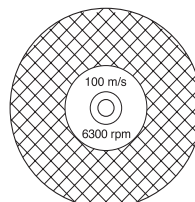

SAFETY INSTRUCTIONS

Ensure the blade is not cracked or damaged in any other way.

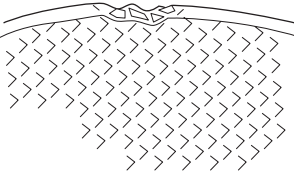

Test the abrasive disc by hanging it on your finger and tapping it lightly with a screwdriver or the like. If the disc does not produce a resonant, ringing sound it is damaged.

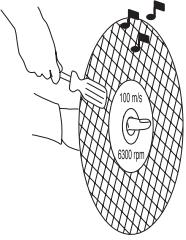

Diamond blades

Diamond blades consist of a steel body provided with segments that contain industrial diamonds.

Diamond blades ensure lower costs per cutting operation, fewer blade changes and a constant cutting depth.

When using diamond blades make sure that it rotates in the direction indicated by the arrow on the blade.

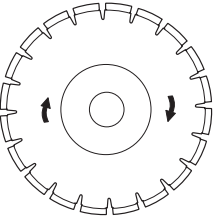

Always use a sharp diamond blade. Sharpen the blade by cutting in a soft material such as sandstone or brick.

Diamond blades are available in several hardness classes. A "soft" diamond blade has a relatively short service life and large cutting capacity. It is used for hard materials such as granite and hard concrete. A "hard" diamond blade has a longer service life and reduced cutting capacity, and should be used for soft materials such as brick and asphalt.

Material

Diamond blades are ideal for masonry, reinforced concrete and other composite materials. Diamond blades are not recommended for cutting metal.

Diamond blades for wet cutting



WARNING! Cool diamond blades for wet cutting continuously with water to prevent overheating, which can cause the blade to break up and eject pieces that can cause injury.

Diamond blades for wet cutting should have water poured over them during the cutting to cool the blade and bond the dust.

Diamond blades for dry cutting

Diamond blades for dry cutting are a new generation of blades that do not require water cooling. However, the blades will still be damaged by excessive heat. It is most economical to allow the blade to cool by simply lifting it out from the cut every 30–60 seconds and letting it rotate in the air for 10 seconds.

ASSEMBLY

Checking the drive axle and flange washers



Check that the threads on the drive shaft are undamaged.

Check that the contact surfaces on the blade and the flange washers are undamaged, of the correct dimension, clean, and that they run properly on the drive axle.

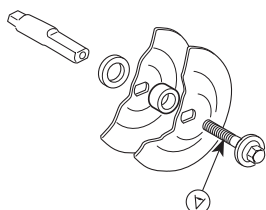

Do not use warped, notched, indented or dirty flange washers. Do not use different dimensions of flange washers.

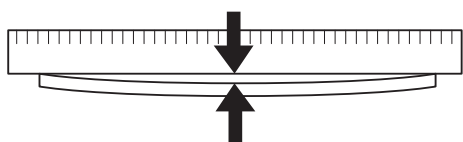

Fitting the cutting blade

Husqvarna's blades are approved for hand-held power cutters. Blades are manufactured with three different diameters of centre holes: 20 mm (0.787"), 22.2 mm (7/8") and 25.4 mm (1"). Bushings can be fitted on the machine axle to adjust the machine to the centre hole of the blade. Use a bushing with the correct diameter! The blades are marked with the diameter of the centre hole.

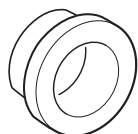

The blade is placed on the bushing (C) between the inner flange washer (A) and the flange washer (B). The flange washer is turned so that it fits on the axle.

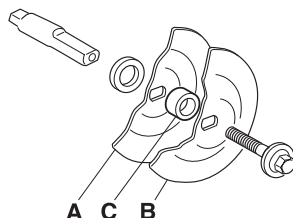
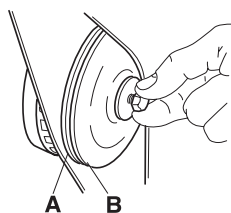

Tightening torque for the bolt holding the blade is: 15-25 Nm (130-215 in.lb).

The shaft can be locked using a screwdriver, steel pin or the like. This is slid in as far as possible. The blade is tightened clockwise.

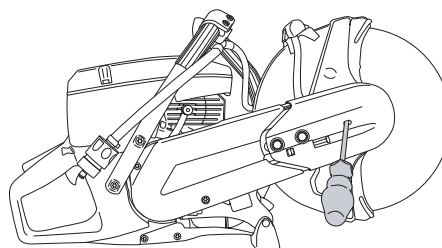

When a diamond blade is mounted on the power cutter make sure that the diamond blade will rotate in the direction indicated by the arrow on the blade.

When the blade is replaced with a new one, check the flange washers and the drive axle. See instructions under the heading Checking the drive axle and flange washers.

Guard for the blade

The guard must always be fitted on the machine. The guard for the cutting equipment should be adjusted so that the rear section is flush with the work piece. Spatter and sparks from the material being cut are then collected up by the guard and led away from the user.

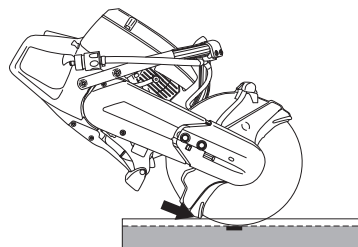

FUEL HANDLING

Fuel

CAUTION! The machine is equipped with a two-stroke engine and must always be run using a mixture of gasoline and two-stroke engine oil. It is important to accurately measure the amount of oil to be mixed to ensure that the correct mixture is obtained. When mixing small amounts of fuel, even small inaccuracies can drastically affect the ratio of the mixture.

WARNING! Always ensure there is adequate ventilation when handling fuel.

Gasoline

- Use good quality unleaded gasoline.

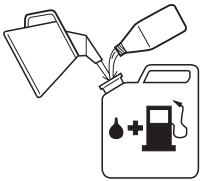

- The lowest recommended octane grade is 87 ((RON+MON)/2). If you run the engine on a lower octane grade than 87 so-called knocking can occur. This gives rise to a high engine temperature and increased bearing load, which can result in serious engine damage.

K750

Two-stroke oil

- For best results and performance use HUSQVARNA two-stroke engine oil, which is specially formulated for our air-cooled two stroke-engines.
- Never use two-stroke oil intended for water-cooled engines, sometimes referred to as outboard oil (rated TCW).
- Never use oil intended for four-stroke engines.

Mixing ratio

1:50 (2%) for all engines.

Gasoline, litre	Two-stroke oil, litre
	2% (1:50)
5	0,10
10	0,20
15	0,30
20	0,40
US gallon	US fl. oz.
1	2 1/2
2 1/2	6 1/2
5	12 7/8

Mixing

- Always mix the gasoline and oil in a clean container intended for fuel.
- Always start by filling half the amount of the gasoline to be used. Then add the entire amount of oil. Mix (shake) the fuel mixture. Add the remaining amount of gasoline.

- Mix (shake) the fuel mixture thoroughly before filling the machine's fuel tank.

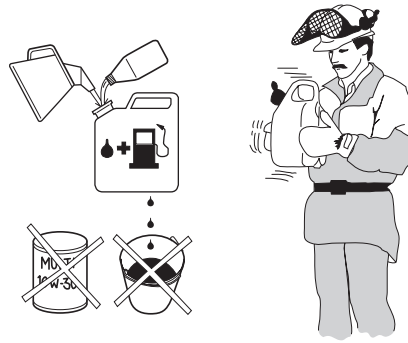

- Do not mix more than one month's supply of fuel at a time.
- If the machine is not used for some time the fuel tank should be emptied and cleaned.

K750 OilGuard

Two-stroke oil

Use HUSQVARNA OilGuard two stroke oil.

Mixing ratio

1:50 (2 %) with HUSQVARNA OilGuard oil

Gasoline, litre	Two stroke oil OilGuard, litre
	2% (1:50)
5	0,10
10	0,20
15	0,30
20	0,40

Mixing

- Always mix the gasoline and oil in a clean container intended for fuel.
- Always start by filling half the amount of the gasoline to be used. Then add the entire amount of oil. Mix (shake) the fuel mixture. Add the remaining amount of gasoline.
- Mix (shake) the fuel mixture thoroughly before filling the machine's fuel tank.

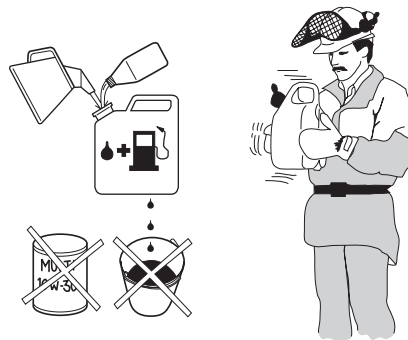

- Do not mix more than one month's supply of fuel at a time.
- If the machine is not used for some time the fuel tank should be emptied and cleaned.

FUEL HANDLING

Disconnection function for OilGuard

Machines fitted with OilGuard have a built-in system for identifying incorrect fuel mixtures. Once the machine is running, a detector reads the fuel quality which takes about ten seconds. If the correct amount of Husqvarna OilGuard oil has been used, the machine will run at a normal speed. If the wrong type of oil has been used, the machine senses this and restricts the speed of the engine to 3,800 rpm to avoid damaging the engine. In order for the machine to run at normal speed again, you must drain the incorrect fuel mixture and then fill the machine with a fuel mixture containing the correct ratio (2 %) of Husqvarna OilGuard oil.

When the machine is delivered, the OilGuard plug A (blue) and the blue indicator pin B are fitted in the tank. If you are in a situation where you do not have access to Husqvarna OilGuard oil, but you have oil of a similar quality, you can deactivate the OilGuard system using the disconnection function. To deactivate the function, pry off the OilGuard plug using a screwdriver and then break off the indicator pin. Now fit the disconnecter plug C (orange) in the tank to complete deactivation and to cover the hole.

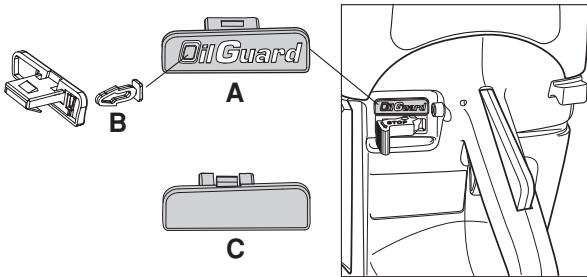

If you want to reactivate the OilGuard system, press the OilGuard plug again. The system is then reactivated, but note that the broken indicator pin cannot be refitted. A broken indicator pin indicates that the OilGuard system has been disconnected. You can purchase a new indicator pin as a spare, but this is only sold in grey which indicates that the OilGuard system has been deactivated since the machine left the factory.

Fueling



WARNING! Taking the following precautions, will lessen the risk of fire:

Do not smoke or place hot objects near fuel.

Always shut off the engine before refuelling.

When refuelling, open the fuel cap slowly so that any excess pressure is released gently.

Tighten the fuel cap carefully after refuelling.

Always move the machine away from the refuelling area before starting.

- Keep the handle dry and free from oil and fuel.
- Ensure that the fuel is well mixed by shaking the container before filling the tank.



- Always exercise care when refilling the fuel. Move the machine at least three metres from the fuelling area before it is started. Check that the fuel cap is tightened correctly.

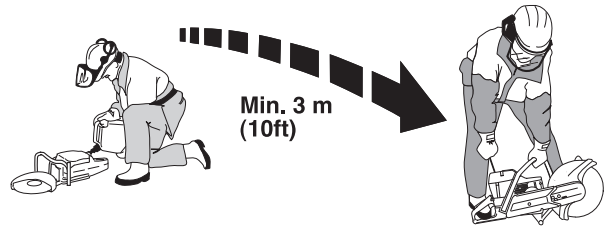

- Clean around the fuel cap. Clean the fuel and oil tank regularly. The fuel filter should be changed at least once a year. Contamination in the tanks causes malfunction.

STARTING AND STOPPING

Starting and stopping



WARNING! Note the following before starting:

Do not start the power cutter without the belt guard fitted. Otherwise the clutch could come loose and cause personal injuries.

Always move the machine away from the refuelling area before starting.

Ensure that you and the machine have a good working stance and that the cutting blade can rotate freely.

Keep people and animals well away from the working area.

Starting a cold engine

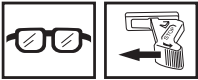

Ignition: Slide the ignition switch to the left.

Choke: Pull the choke control fully out.

Start throttle lock: Press in the throttle trigger lock, throttle control and then the start throttle lock (A). Release the throttle control and it is locked in the half throttle position. The lock releases when the throttle control is pressed in fully.

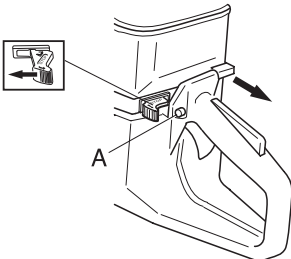

Decompression valve:

Press in the valve to reduce the pressure in the cylinder, this is to assist starting the power cutter. The decompression valve should always be used when starting. The valve automatically returns to its initial position when the machine starts.

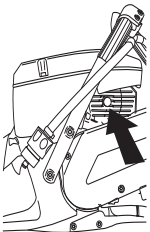

Starting a warm engine

Use the same starting procedure as for a cold engine but without setting the choke control in the choke position.

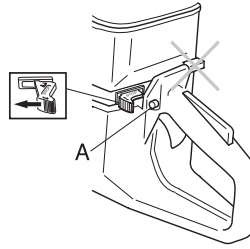

Starting



WARNING! The cutting blade rotates when the engine is started. Make sure it can rotate freely.

Grip the front handle with your left hand. Put your right foot on the lower section of the rear handle pressing the machine against the ground. **Never wrap the starter cord around your hand**

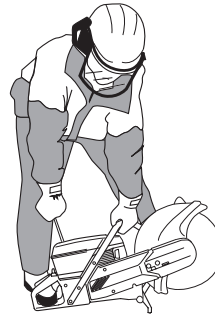

Grip the starter handle, slowly pull out the cord with your right hand until you feel some resistance (the starter pawls grip), now quickly and powerfully pull the cord.

CAUTION! Do not pull the starter cord all the way out and do not let go of the starter handle when the cord is fully extended. This can damage the machine.

When the engine starts, quickly apply full throttle to automatically disengage fast idle.

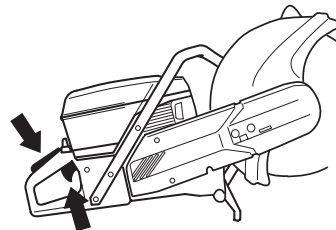

Stopping

The engine is stopped by switching the ignition off using the stop switch.

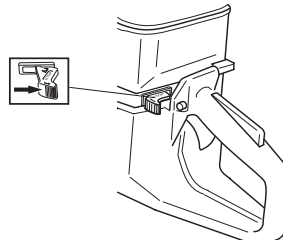

MAINTENANCE

Tensioning the drive belt

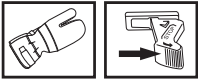

- When the machine is equipped with a friction retarder, a scraping sound can be heard from the bearing housing when the blade is turned by hand. This is quite normal. Please contact an accredited Husqvarna workshop if you have any questions.
- The drive belt is fully enclosed and well protected from dust and dirt.
- When the drive belt is to be tensioned, release the bolts holding the cutting arm.

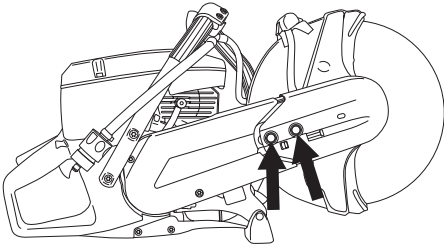

- Screw the adjuster screw so that the square headed nut comes opposite the marking on the cover. This automatically ensures that the belt has the correct tension.

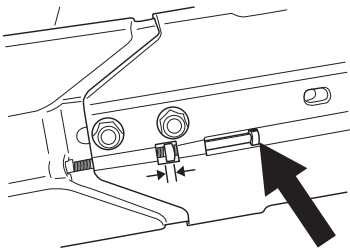

- Tighten both of the screws holding the cutting head using a T-wrench.

IMPORTANT INFORMATION The tension of a new drive belt must be readjusted after one or two tanks of fuel have been used.

Replacing the drive belt

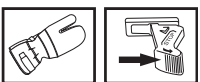

- First release the two bolts and then the adjuster screw to release the belt tension.

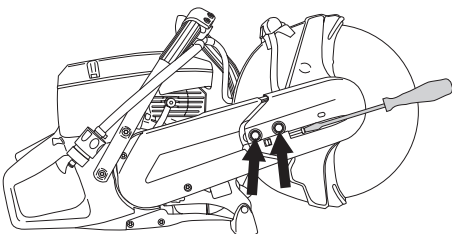

- Now unscrew the bolts and dismantle the belt guard.

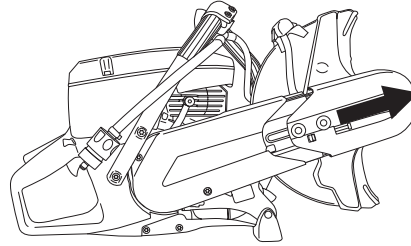

- Remove the belt from the belt pulley.
- The cutting head is now loose and can be removed from the machine. Remove the rear belt guard by releasing the two screws holding the guard.

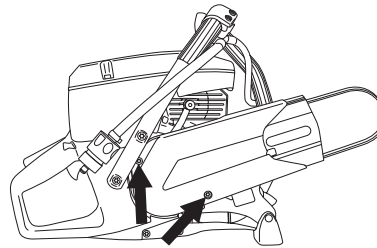

- Replace the drive belt.
- Assemble in the reverse order as set out for dismantling.
- Check that the guard over the cutting blade is not cracked or damaged in any other way. Replace when damaged.

Belt pulley and clutch

Never start the engine when the belt pulley and clutch are removed for maintenance.

Carburetor



WARNING! Do not start the machine without the cutting arm or cutting head fitted. Otherwise the clutch could come loose and cause personal injuries.

The carburettor is equipped with fixed needles to ensure the machine always receives the correct mixture of fuel and air. When the engine lacks power or accelerates poorly, do the following:

- Check the air filter and replace if necessary.
- When this does not help, contact an authorised service workshop.

MAINTENANCE

Adjusting the idle speed

Adjust the idle speed using the T screw. When an adjustment is necessary, first turn the screw clockwise until the blade starts to rotate. Now turn the screw anti-clockwise until the blade stops rotating.

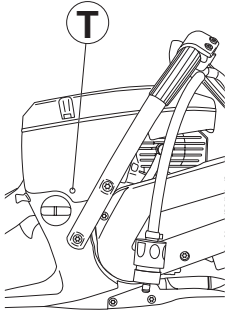

Rec. idle speed: 2700 rpm



WARNING! If the idle speed cannot be adjusted so that the cutting attachment stops, contact your dealer/service workshop. Do not use the machine until it has been correctly adjusted or repaired.

Fuel filter

- The fuel filter sits inside the fuel tank.
- The fuel tank must be protected from contamination when filling. This reduces the risk of operating disturbances caused by blockage of the fuel filter located inside the tank.
- The filter cannot be cleaned but must be replaced with a new filter when it is clogged. **The filter should be changed at least once per year.**

Air filter



Air filters must be regularly cleaned to remove dust and dirt in order to avoid:

- Carburettor malfunctions
- Starting problems
- Loss of engine power
- Unnecessary wear to engine parts
- Excessive fuel consumption.

The air filter system consists of an oiled foam plastic filter (1) and a paper filter (2):

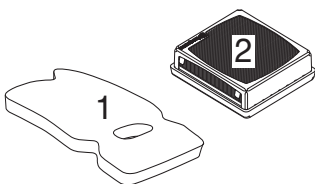

- 1 The foam plastic filter is easily accessible under the filter cover A. This filter should be checked weekly and replaced if necessary.

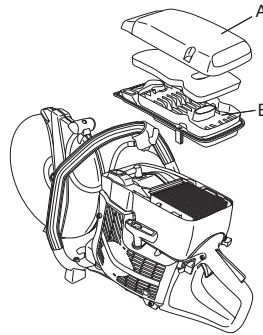

In order to obtain a good filtering effect, the filter must be replaced regularly or cleaned and oiled. A special HUSQVARNA oil has been produced for this purpose.

Remove the foam plastic filter. Wash the filter well in tepid soapy water. After cleaning, rinse the filter well in clean water. Squeeze out and allow the filter to dry. **NOTE!** High pressure compressed air can damage the foam.



Put the filter in a plastic bag and pour the filter oil over it. Knead the plastic bag to distribute the oil. Squeeze the excess oil out of the filter inside the plastic bag and pour off the excess before fitting the filter to the machine. **CAUTION!** Never use common engine oil

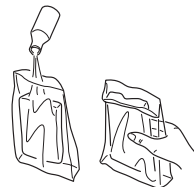

- 2 The paper filter is accessible under cover B. This filter must be replaced/cleaned when the engine's power drops or each month. The filter is cleaned by shaking. Note that the filter must not be washed. **NOTE!** High pressure compressed air can damage the filter.

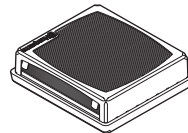

An air filter that has been in use for a long time cannot be cleaned completely. The filter must therefore be replaced with a new one at regular intervals. **A damaged air filter must always be replaced.**

IMPORTANT INFORMATION

Poor maintenance of the air filter will cause carbon build-up on the spark plug and abnormal wear to engine parts.

MAINTENANCE

Starter



WARNING! When the recoil spring is wound up in the starter housing it is under tension and can, if handled carelessly, pop out and cause personal injury.

Always be careful when changing the recoil spring or the starter cord. Always wear protective goggles.

Changing a broken or worn starter cord



- Loosen the screws that hold the starter against the crankcase and remove the starter.

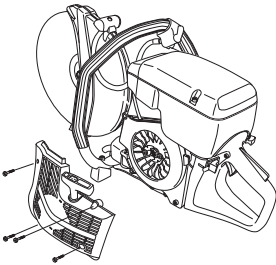

- Pull the cord out about 30 cm and lift it into the cut-out in the periphery of the starter pulley. When the cord is intact: Release the spring tension by letting the pulley rotate slowly backwards.

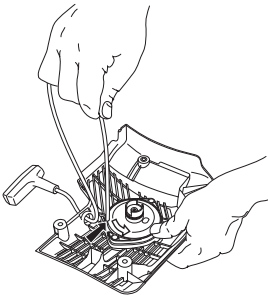

Remove any remnants of the old starter cord and check that the return spring works. Insert the new starter cord through the hole in the starter housing and in the cord pulley.

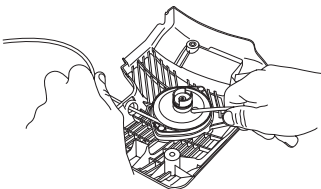

Secure the starter cord around the cord pulley as illustrated. Tighten the fastening well and ensure that the free end is as short as possible. Secure the end of the starter cord in the starter handle.

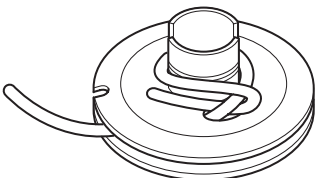

Guide the cord through the cut-out in the periphery of the pulley and wind the cord 3 times clockwise around the centre of the starter pulley.

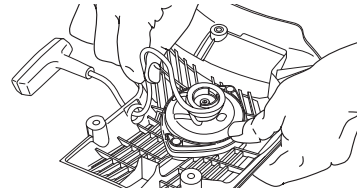

Now pull the starter handle and in doing so tension the spring. Repeat the procedure once more, but this time with four turns.

Note that the starter handle is drawn to its correct home position after tensioning the spring.

Check that the spring is not drawn to its end position by pulling out the starter line fully. Slow the starter pulley with your thumb and check that you can turn the pulley at least a further half turn.

Tensioning the recoil spring

- Hook the starter cord in the notch in the pulley and turn the starter pulley about 2 turns clockwise.

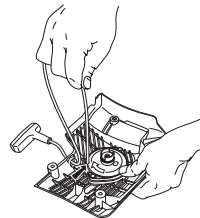

Changing a broken recoil spring



- Undo the bolt in the centre of the pulley and remove the pulley.

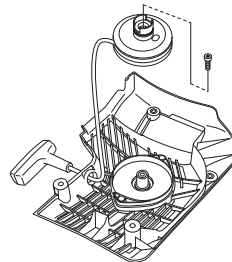

- Bear in mind that the return spring lies tensioned in the starter housing.
- Loosen the bolts holding the spring cassette.

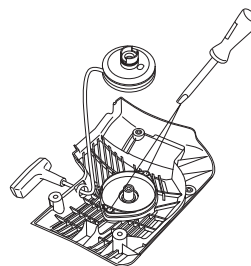

MAINTENANCE

- Remove the recoil spring by turning the starter over and loosen the hooks, with the help of a screwdriver. The hooks hold the return spring assembly on the starter.

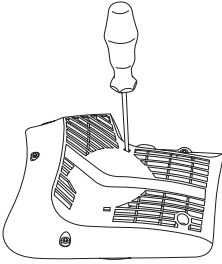

- Lubricate the recoil spring with light oil. Fit the pulley and tension the recoil spring.

Fitting the starter

- To fit the starter, first pull out the starter cord and place the starter in position against the crankcase. Then slowly release the starter cord so that the pulley engages with the pawls.

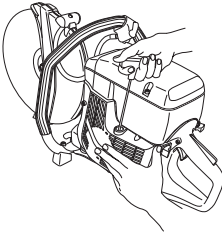

- Tighten the screws.

Spark plug



The spark plug condition is influenced by:

- Wrong fuel mixture (too much oil).
- Dirty filters.

These factors cause deposits on the spark plug electrodes, which may result in operating problems and starting difficulties.

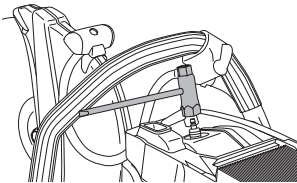

- If the machine is low on power, difficult to start or runs poorly at idle speed: always check the spark plug first before taking other steps. If the spark plug is dirty, clean it and at the same time check that the electrode gap is 0.5 mm.

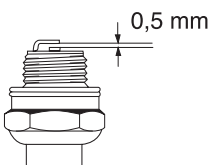

CAUTION! Always use the recommended spark plug type! Use of the wrong spark plug can damage the piston/cylinder.

Cooling system

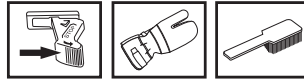

To keep the working temperature as low as possible the machine is equipped with a cooling system.

The cooling system consists of:

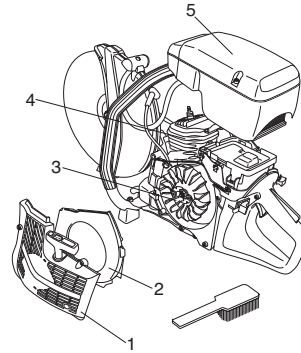

- Air intake on the starter.
- Air guide plate.
- Fins on the flywheel.
- Cooling fins on the cylinder.
- Cylinder cover

Clean the cooling system with a brush once a week, more often in demanding conditions. A dirty or blocked cooling system results in the machine overheating which causes damage to the piston and cylinder.

Muffler



The muffler is designed to reduce the noise level and to direct the exhaust gases away from the operator. The exhaust gases are hot and can contain sparks, which may cause fire if directed against dry and combustible material.



Never use a machine with a defective muffler.



MAINTENANCE

General maintenance instructions

Below you will find some general maintenance instructions. If you have more questions, contact your service agent.

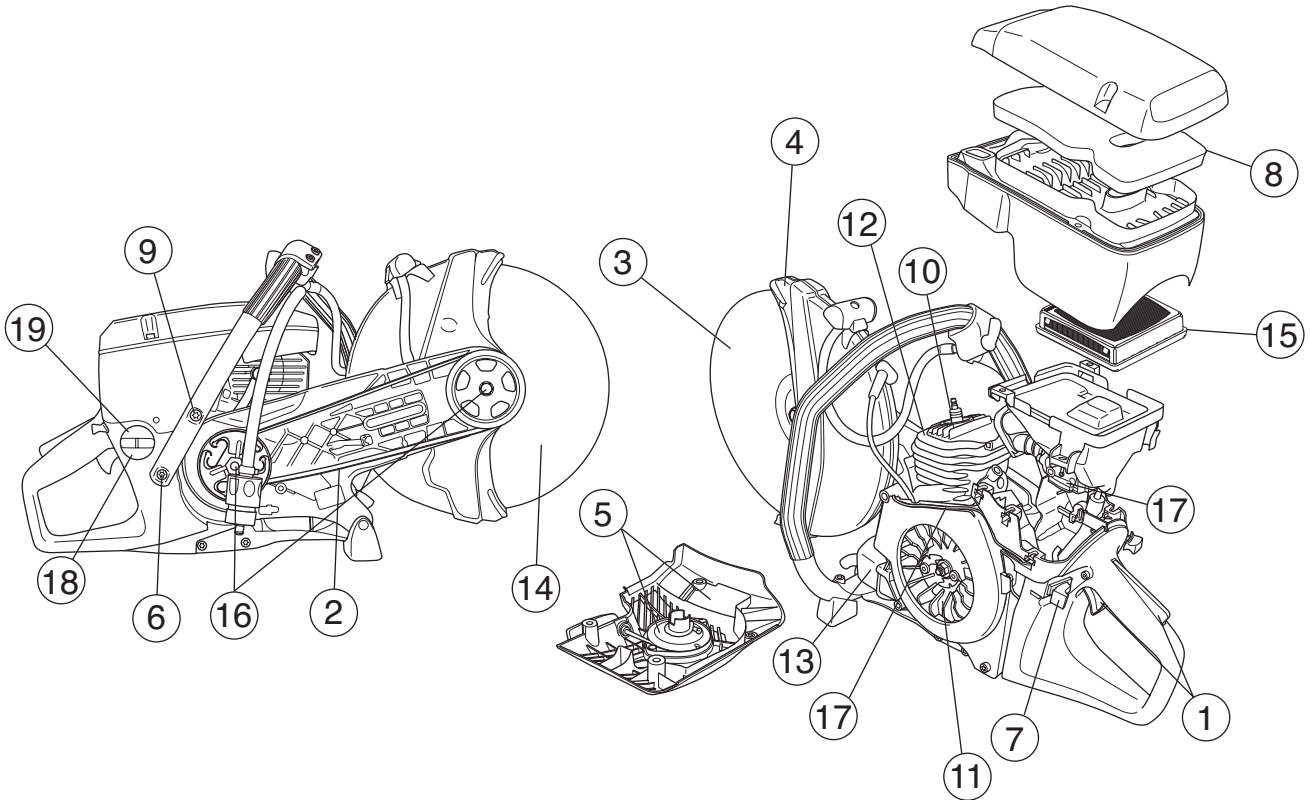

Daily maintenance

- 1 Check that the components of the throttle control work smoothly (throttle control and throttle trigger lock).
- 2 Check the tension of the drive belt.
- 3 Check the condition of the blade and the drive gear.
- 4 Check the condition of the blade guard.
- 5 Check the starter and starter cord and clean the outside of the starter unit's air intake.
- 6 Check that nuts and screws are tight.
- 7 Check that the stop switch works correctly.

Weekly maintenance

- 8 Check, clean or replace the foam plastic filter.
- 9 Check that the handles and vibration damping elements are not damaged.
- 10 Clean the spark plug. Check that the electrode gap is 0.020 inch (0.5 mm).
- 11 Clean the fins on the flywheel. Check the starter and the recoil spring.
- 12 Clean the cooling fins on the cylinder.
- 13 Check that the muffler is securely attached and not damaged.
- 14 Check the idling setting and adjust if necessary.

Monthly maintenance

- 15 Check the paper filter
- 16 Check the clutch centre, drive gear and clutch spring for wear.
- 17 Clean the outside of the carburetor.
- 18 Check fuel hose for cracks or other damage. Change if necessary.
- 19 Check that the fuel cap and its seal are not damaged.
- 20 Check all cables and connections.

TECHNICAL DATA

Technical data

Engine

Cylinder displacement, cu.in/cm ³	K750 74
Cylinder bore, inch/mm	2,0/51
Stroke, inch/mm	1,42/36
Idle speed, rpm	2700
Recommended max. speed, rpm	9300 (+/- 150)
Power, kW/ rpm	3,7/9000

Ignition system

Manufacturer of ignition system	SEM
Type of ignition system	CD
Spark plug	Champion RCJ 6Y
Electrode gap, inch/mm	0,02/0,5

Fuel and lubrication system

Manufacturer of carburetor	Zama
Carburetor type	C3
Fuel tank capacity, US pint/litre	1,9/0,9

Weight

Power cutter without fuel and cutting blade, Lbs/kg	
12" (300 mm)	20,7/9,4
14" (350 mm)	21,6/9,8

Cutting equipment

Cutting blade	Max. peripheral speed, m/s	Max. speed of output shaft, rpm
12" (300 mm)	80	4650
14" (350 mm)	100	4650



FEDERAL EMISSION CONTROL WARRANTY STATEMENT

YOUR WARRANTY RIGHTS AND OBLIGATIONS

The EPA (The US Environmental Protection Agency), Environment Canada and Husqvarna Construction Products are pleased to explain the emissions control system warranty on your 2001 and later small nonroad engine. In U.S. and Canada, new small nonroad engines must be designed, built and equipped to meet the federal stringent anti-smog standards. Husqvarna Construction Products must warrant the emission control system on your small nonroad engine for the period of time listed below provided there has been no abuse, neglect or improper maintenance of your unit. Your emission control system includes Parts such as the carburetor and the ignition system. Where a warrantable condition exists, Husqvarna Construction Products will repair your small nonroad engine at no cost to you. Expenses covered under warranty include diagnosis, parts and labor.

MANUFACTURER'S WARRANTY COVERAGE

The 2001 and later small nonroad engines are warranted for two years. If any emission related part on you engine (as listed above) is defective, the part will be repaired or replaced by Husqvarna Construction Products.

OWNER'S WARRANTY RESPONSIBILITIES

As the small nonroad engine owner, you are responsible for the performance of the required maintenance listed in your Operator's Manual. Husqvarna Construction Products recommends that you retain all receipts covering maintenance on your small nonroad engine, but Husqvarna Construction Products cannot deny warranty solely for the lack of receipts or for your failure to ensure the performance of all scheduled maintenance. As the small nonroad engine owner, you should, however, be aware that Husqvarna Construction Products may deny you warranty coverage if your small nonroad engine or a part of it has failed due to abuse, neglect, improper maintenance, unapproved modifications or the use of parts not made or approved by the original equipment manufacturer. You are responsible for presenting your small nonroad engine to a Husqvarna Construction Products authorized servicing dealer as soon as a problem exists. The warranty repairs should be completed in a reasonable amount of time, not to exceed 30 days. If you have any questions regarding your warranty rights and responsibilities, you should contact your nearest authorized servicing dealer or call Husqvarna Construction Products, at 1-800-323 3553.

WARRANTY COMMENCEMENT DATE

The warranty period begins on the date small nonroad engine is delivered.

LENGTH OF COVERAGE

Husqvarna Construction Products warrants to the initial owner and each subsequent purchaser that the engine is free from defects in materials and workmanship which cause the failure of a warranted part for a period of two years.

WHAT IS COVERED

REPAIR OR REPLACEMENT OF PARTS Repair or replacement of any warranted part will be performed at no charge to the owner at an approved Husqvarna Construction

Products servicing dealer. If you have any questions regarding your warranty rights and responsibilities, you should contact your nearest authorized servicing dealer or call Husqvarna Construction Products, at 1-800-323 3553.

WARRANTY PERIOD Any warranted part which is not scheduled for replacement as required maintenance, or which is scheduled only for regular inspection to the effect of "repair or replace as necessary" shall be warranted for 2 years. Any warranted part which is scheduled for replacement as required maintenance shall be warranted for the period of time up to the first scheduled replacement point for that part.

DIAGNOSIS The owner shall not be charged for diagnostic labor which leads to the determination that a warranted part is defective, if the diagnostic work is performed at an approved Husqvarna Construction Products servicing dealer.

CONSEQUENTIAL DAMAGES Husqvarna Construction Products may be liable for damages to other engine components caused by the failure of a warranted part still under warranty.

WHAT IS NOT COVERED

All failures caused by abuse, neglect or improper maintenance are not covered.

ADD -ON OR MODIFIED PARTS

The use of add-on or modified parts can be grounds for disallowing a warranty claim. Husqvarna Construction Products is not liable to cover failures of warranted parts caused by the use of add-on or modified parts.

HOW TO FILE A CLAIM

If you have any questions regarding your warranty rights and responsibilities, you should contact your nearest authorized servicing dealer or call Husqvarna Construction Products, at 1-800-323 3553.

WHERE TO GET WARRANTY SERVICE

Warranty services or repairs shall be provided at all Husqvarna Construction Products authorized servicing dealers.

MAINTENANCE, REPLACEMENT AND REPAIR OF EMISSION-RELATED PARTS

Any Husqvarna Construction Products approved replacement part used in the performance of any warranty maintenance or repairs on emission-related parts, will be provided without charge to the owner if the part is under warranty.

EMISSION CONTROL WARRANTY PARTS LIST

- 1 Carburetor and internal parts
- 2 Intake pipe, airfilter holder and carburetor bolts.
- 3 Airfilter and fuelfilter covered up to maintenance schedule.
- 4 Ignition System
 - 1 Spark Plug, covered up to maintenance schedule
 - 2 Ignition Module

MAINTENANCE STATEMENT

The owner is responsible for the performance of all required maintenance, as defined in the operator's manual.

1150900-95



2007-06-20