

Operator's manual
323RII 327R_X-series
327RD_X-series

Please read the operator's manual carefully and make sure you understand the instructions before using the machine.

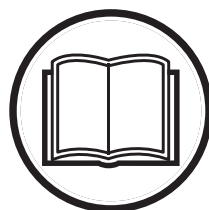

English

KEY TO SYMBOLS

Symbols

WARNING! Clearing saws, brushcutters and trimmers can be dangerous! Careless or incorrect use can result in serious or fatal injury to the operator or others. It is extremely important that you read and understand the contents of the operator's manual.



Please read the operator's manual carefully and make sure you understand the instructions before using the machine.



Always wear:

- A protective helmet where there is a risk of falling objects
- Approved hearing protection
- Approved eye protection



Max. speed of output shaft, rpm



This product is in accordance with applicable EC directives.



Watch out for thrown objects and ricochets.



The operator of the machine must ensure, while working, that no persons or animals come closer than 15 metres.



Machines fitted with saw blades or grass blades can be thrown violently to the side when the blade comes into contact with a fixed object. This is called blade thrust. The blade is capable of amputating an arm or leg. Always keep people and animals at least 15 metres from the machine.



Arrows which show limits for handle positioning.



Always wear approved protective gloves.



Wear sturdy, non-slip boots.



Only use non-metallic, flexible cutting attachments, i.e. trimmer heads with trimmer cord.



Noise emission to the environment according to the European Community's Directive. The machine's emission is specified in chapter Technical data and on label.



Other symbols/decals on the machine refer to special certification requirements for certain markets.

The engine is switched off by moving the stop switch to the stop position.

CAUTION! The stop switch automatically returns to the start position. In order to prevent unintentional starting, the spark plug cap must be removed from the spark plug when assembling, checking and/or performing maintenance.

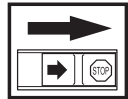

Always wear approved protective gloves.

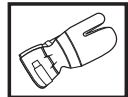

Regular cleaning is required.

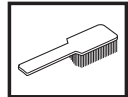

Visual check.



Approved eye protection must always be used.



CONTENTS

Contents

KEY TO SYMBOLS

Symbols 2

CONTENTS

Contents 3

Note the following before starting: 3

INTRODUCTION

Dear Customer, 4

WHAT IS WHAT?

What is what on the clearing saw? 5

GENERAL SAFETY PRECAUTIONS

Important 6

Personal protective equipment 6

Machine's safety equipment 7

Cutting equipment 10

ASSEMBLY

Fitting the handlebar (323RII) 12

Fitting the handlebar (327Rx, 327RDx) 12

Assembling and dismantling the two-piece shaft (327RDx) 13

Assembling the cutting equipment 14

Fitting a blade guard, grass blade and grass cutter 14

Fitting the blade guard and saw blade 14

Fitting other guards and cutting attachments 15

Adjusting the harness and clearing saw 16

Standard harness 16

FUEL HANDLING

Fuel safety 17

Fuel 17

Fuelling 18

STARTING AND STOPPING

Check before starting 19

Starting and stopping 19

WORKING TECHNIQUES

General working instructions 21

MAINTENANCE

Carburettor 26

Muffler 28

Cooling system 29

Bevel gear 29

Air filter 29

Two-piece shaft 30

Spark plug 30

Maintenance schedule 31

TECHNICAL DATA

Technical data 32

EC-declaration of conformity 33

Note the following before starting:

Please read the operator's manual carefully.



WARNING! Long-term exposure to noise can result in permanent hearing impairment. So always use approved hearing protection.



WARNING! Under no circumstances may the design of the machine be modified without the permission of the manufacturer. Always use genuine accessories. Non-authorized modifications and/or accessories can result in serious personal injury or the death of the operator or others.



WARNING! A clearing saw, brushcutter or trimmer can be dangerous if used incorrectly or carelessly, and can cause serious or fatal injury to the operator or others. It is extremely important that you read and understand the contents of this operator's manual.

INTRODUCTION

Dear Customer,

Congratulations on your choice to buy a Husqvarna product! Husqvarna is based on a tradition that dates back to 1689, when the Swedish King Karl XI ordered the construction of a factory on the banks of the Husqvarna River, for production of muskets. The location was logical, since water power was harnessed from the Husqvarna River to create the water-powered plant. During the more than 300 years of being, the Husqvarna factory has produced a lot of different products, from wood stoves to modern kitchen appliances, sewing machines, bicycles, motorcycles etc. In 1956, the first motor driven lawn mowers appeared, followed by chain saws in 1959, and it is within this area Husqvarna is working today.

Today Husqvarna is one of the leading manufacturers in the world of forest and garden products, with quality as our highest priority. The business concept is to develop, manufacture and market motor driven products for forestry and gardening as well as for building and construction industry. Husqvarna's aim is also to be in the front edge according to ergonomics, usability, security and environmental protection. That is the reason why we have developed many different features to provide our products within these areas.

We are convinced that you will appreciate with great satisfaction the quality and performance of our product for a very long time to come. The purchase of one of our products gives you access to professional help with repairs and service whenever this may be necessary. If the retailer who sells your machine is not one of our authorised dealers, ask for the address of your nearest service workshop.

It is our wish that you will be satisfied with your product and that it will be your companion for a long time. Think of this operator's manual as a valuable document. By following its' content (using, service, maintenance etc) the life span and the second-hand value of the machine can be extended. If you will sell this machine, make sure that the buyer will get the operator's manual.

Thank you for using a Husqvarna product.

Husqvarna AB has a policy of continuous product development and therefore reserves the right to modify the design and appearance of products without prior notice.

WHAT IS WHAT?

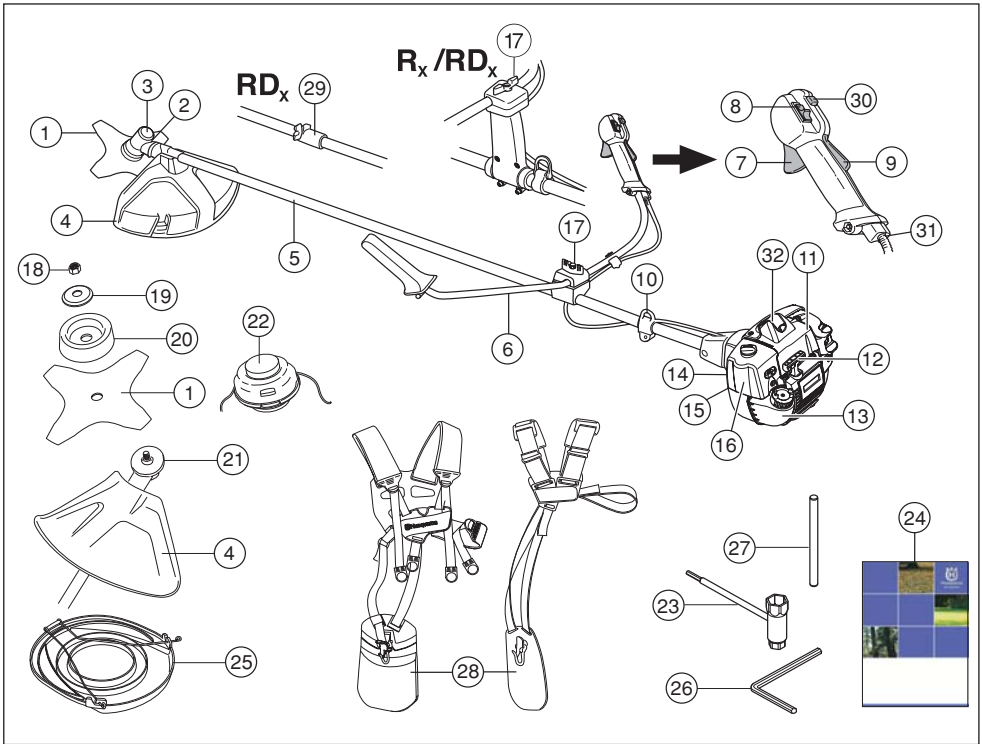

What is what on the clearing saw?

- | | |
|---------------------------------|----------------------------------|
| 1 Blade | 17 Handle adjustment |
| 2 Grease filler cap, bevel gear | 18 Locking nut |
| 3 Bevel gear | 19 Support flange |
| 4 Cutting attachment guard | 20 Support cup |
| 5 Shaft | 21 Drive disc |
| 6 Handlebar | 22 Trimmer head |
| 7 Throttle control | 23 Socket spanner |
| 8 Stop switch | 24 Operator's manual |
| 9 Throttle lockout | 25 Transport guard |
| 10 Suspension ring | 26 Allen key |
| 11 Cylinder cover | 27 Locking pin |
| 12 Starter handle | 28 Harness |
| 13 Fuel tank | 29 Shaft coupling (327RDx) |
| 14 Choke control | 30 Start throttle button |
| 15 Air purge | 31 Adjusting the throttle wire |
| 16 Air filter cover | 32 Spark plug cap and spark plug |

GENERAL SAFETY PRECAUTIONS

Important

IMPORTANT!

The machine is only designed for trimming grass, grass clearing and/or forestry clearing.

The only accessories you can operate with this engine unit are the cutting attachments we recommend in the chapter on Technical data.

Never use the machine if you are tired, if you have drunk alcohol, or if you are taking medication that could affect your vision, your judgement or your co-ordination.

Wear personal protective equipment. See instructions under the heading Personal protective equipment.

Never use a machine that has been modified in any way from its original specification.

Never use a machine that is faulty. Carry out the checks, maintenance and service instructions described in this manual. Some maintenance and service measures must be carried out by trained and qualified specialists. See instructions under the heading Maintenance.

All covers, guards and handles must be fitted before starting. Ensure that the spark plug cap and ignition lead are undamaged to avoid the risk of electric shock.

The machine operator must ensure that no people or animals come closer than 15 metres while working. When several operators are working in the same area the safety distance should be at least twice the tree height and no less than 15 metres.



WARNING! The ignition system of this machine produces an electromagnetic field during operation. This field may under some circumstances interfere with pacemakers. To reduce the risk of serious or fatal injury, we recommend persons with pacemakers to consult their physician and the pacemaker manufacturer before operating this machine.



WARNING! Running an engine in a confined or badly ventilated area can result in death due to asphyxiation or carbon monoxide poisoning.



WARNING! Never allow children to use or be in the vicinity of the machine. As the machine is equipped with a spring-loaded stop switch and can be started by low speed and force on the starter handle, even small children under some circumstances can produce the force necessary to start the machine. This can mean a risk of serious personal injury. Therefore remove the spark plug cap when the machine is not under close supervision.

Personal protective equipment

IMPORTANT!

A clearing saw, brushcutter or trimmer can be dangerous if used incorrectly or carelessly, and can cause serious or fatal injury to the operator or others. It is extremely important that you read and understand the contents of this operator's manual.

You must use approved personal protective equipment whenever you use the machine. Personal protective equipment cannot eliminate the risk of injury but it will reduce the degree of injury if an accident does happen. Ask your dealer for help in choosing the right equipment.



WARNING! Listen out for warning signals or shouts when you are wearing hearing protection. Always remove your hearing protection as soon as the engine stops.

HELMET

A helmet should be worn if the trees being cleared are taller than 2 m.



HEARING PROTECTION

Wear hearing protection that provides adequate noise reduction.



EYE PROTECTION

Always wear approved eye protection. If you use a visor then you must also wear approved protective goggles. Approved protective goggles must comply with standard ANSI Z87.1 in the USA or EN 166 in EU countries.



GLOVES

Gloves should be worn when necessary, e.g., when fitting cutting attachments.



GENERAL SAFETY PRECAUTIONS

BOOTS

Wear boots with steel toe-caps and non-slip sole.



CLOTHING

Wear clothes made of a strong fabric and avoid loose clothing that can catch on twigs and branches. Always wear heavy, long pants. Do not wear jewellery, shorts sandals or go barefoot. Secure hair so it is above shoulder level.

FIRST AID KIT

Always have a first aid kit nearby.



Machine's safety equipment

This section describes the machine's safety equipment, its purpose, and how checks and maintenance should be carried out to ensure that it operates correctly. See the "What is what?" section to locate where this equipment is positioned on your machine.

The life span of the machine can be reduced and the risk of accidents can increase if machine maintenance is not carried out correctly and if service and/or repairs are not carried out professionally. If you need further information please contact your nearest service workshop.

IMPORTANT! All servicing and repair work on the machine requires special training. This is especially true of the machine's safety equipment. If your machine fails any of the checks described below you must contact your service agent. When you buy any of our products we guarantee the availability of professional repairs and service. If the retailer who sells your machine is not a servicing dealer, ask him for the address of your nearest service agent.



WARNING! Never use a machine with faulty safety equipment. The machine's safety equipment must be checked and maintained as described in this section. If your machine fails any of these checks contact your service agent to get it repaired.

Throttle lockout

The throttle lockout is designed to prevent accidental operation of the throttle control. When you press the lock (A) (i.e. when you grasp the handle) it releases the throttle control (B). When you release the handle the throttle control and the throttle lockout both move back to their

original positions. This movement is controlled by two independent return springs. This arrangement means that the throttle control is automatically locked at the idle setting.

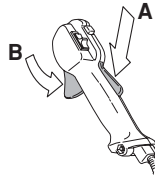

Make sure the throttle control is locked at the idle setting when the throttle lockout is released.

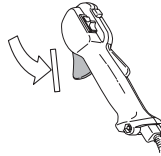

Press the throttle lockout and make sure it returns to its original position when you release it.



Check that the throttle control and throttle lockout move freely and that the return springs work properly.

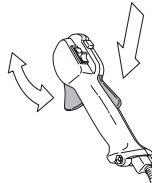

See instructions under the heading Start. Start the machine and apply full throttle. Release the throttle and check that the cutting attachment stops and remains at a standstill. If the cutting attachment rotates with the throttle in the idle position then the carburettor idle setting must be checked. See instructions under the heading Maintenance.

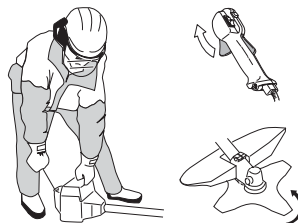

GENERAL SAFETY PRECAUTIONS

Stop switch

Use the stop switch to switch off the engine.

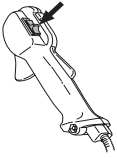

Start the engine and make sure the engine stops when you move the stop switch to the stop setting.

Cutting attachment guard



This guard is intended to prevent loose objects from being thrown towards the operator. The guard also protects the operator from accidental contact with the cutting attachment.

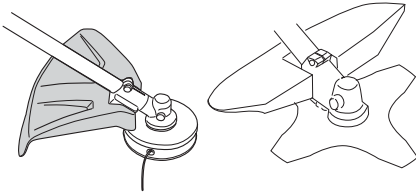

Check that the guard is undamaged and not cracked. Replace the guard if it has been exposed to impact or is cracked.

Always use the recommended guard for the cutting attachment you are using. See chapter on Technical data.



WARNING! Never use a cutting attachment without an approved guard. See the chapter on Technical data. If an incorrect or faulty guard is fitted this can cause serious personal injury.

Vibration damping system



Your machine is equipped with a vibration damping system that is designed to minimize vibration and make operation easier.

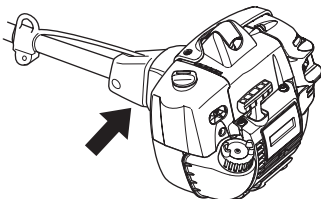

Using incorrectly wound cord or a blunt or incorrect cutting attachment (wrong type or incorrectly filed, see instructions under the heading Filing the blade) increases the level of vibration.

The machine's vibration damping system reduces the transfer of vibration between the engine unit/cutting equipment and the machine's handle unit.

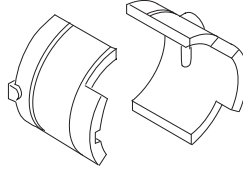

Regularly check the vibration damping units for cracks or deformation. Check that the vibration damping element is undamaged and securely attached.



WARNING! Overexposure to vibration can lead to circulatory damage or nerve damage in people who have impaired circulation. Contact your doctor if you experience symptoms of overexposure to vibration. Such symptoms include numbness, loss of feeling, tingling, pricking, pain, loss of strength, changes in skin colour or condition. These symptoms normally appear in the fingers, hands or wrists. The risk increases at low temperatures.

Quick release

There is an easily accessible, quick release fitted at the front as a safety precaution in case the engine catches fire, or in any other situation that requires you to free yourself from the machine and harness. See instructions under the heading Adjusting the harness and clearing saw.

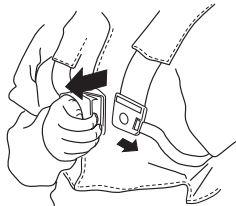

Check that the harness straps are correctly positioned. Once the harness and machine have been adjusted, check that the harness quick release works correctly.

Muffler



The muffler is designed to keep noise levels to a minimum and to direct exhaust fumes away from the user. A muffler

GENERAL SAFETY PRECAUTIONS

fitted with a catalytic converter is also designed to reduce harmful exhaust gases.



In countries that have a warm and dry climate there is a significant risk of fire. We therefore fit certain mufflers with a spark arrestor mesh. Check whether the muffler on your machine is fitted with this kind of mesh.

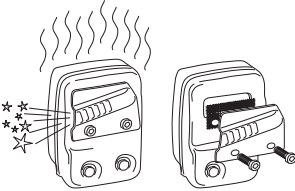

For mufflers it is very important that you follow the instructions on checking, maintaining and servicing your machine.

Never use a machine that has a faulty muffler.



Regularly check that the muffler is securely attached to the machine.



If the muffler on your machine is fitted with a spark arrestor mesh this must be cleaned regularly. A blocked mesh will cause the engine to overheat and may lead to serious damage.



WARNING! Mufflers fitted with catalytic converters get very hot during use and remain so for some time after stopping. This also applies at idle speed. Contact can result in burns to the skin. Remember the risk of fire!



WARNING! The inside of the muffler contain chemicals that may be carcinogenic. Avoid contact with these elements in the event of a damaged muffler.



WARNING! Bear in mind that:

The exhaust fumes from the engine are hot and may contain sparks which can start a fire. Never start the machine indoors or near combustible material!



Locking nut



A locking nut is used to secure some types of cutting attachment.

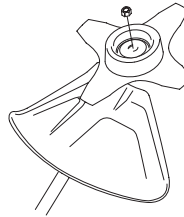

When fitting, tighten the nut in the opposite direction to the direction of rotation of the cutting attachment. To remove it, undo the nut in the same direction as the cutting attachment rotates. (CAUTION! The nut has a left-hand thread.) Tighten the nut using the socket spanner.

When loosening and tightening the saw blade nut, there is a risk of injury from the teeth of the saw blade. You should therefore always ensure that your hand is shielded by the blade guard when doing this. Always use a socket spanner with a shaft that is long enough to allow this. The arrow in the diagram shows the area where you should operate the socket spanner when loosening or tightening the nut.

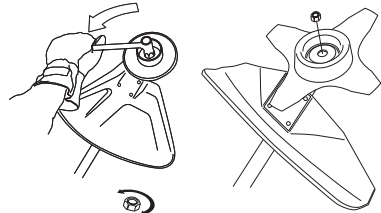

The nylon lining inside the locking nut must not be so worn that you can turn it by hand. The lining should offer a resistance of at least 1.5 Nm. The nut should be replaced after it has been put on approx. 10 times.

GENERAL SAFETY PRECAUTIONS

Cutting equipment

This section describes how to choose and maintain your cutting equipment in order to:

- Reduce the risk of blade thrust.
- Obtain maximum cutting performance.
- Extend the life of cutting equipment.

IMPORTANT!

Only use cutting attachments with the guards we recommend! See the chapter on Technical data.

Refer to the instructions for the cutting attachment to check the correct way to load the cord and the correct cord diameter.

Keep the teeth of the blade correctly sharpened! Follow our recommendations. Also refer to the instructions on the blade packaging.

Maintain the correct blade setting! Follow our instructions and use the recommended file gauge.



WARNING! Always stop the engine before doing any work on the cutting attachment. This continues to rotate even after the throttle has been released. Ensure that the cutting attachment has stopped completely and disconnect the HT lead from the spark plug before you start to work on it.



WARNING! Using an incorrect cutting attachment or an incorrectly sharpened blade increases the risk of blade thrust.

Cutting equipment

Saw blades are intended for cutting fibrous types of wood.

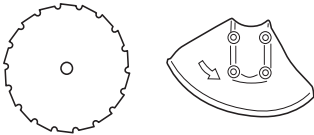

Grass blades and grass cutters are intended for cutting coarse grass.

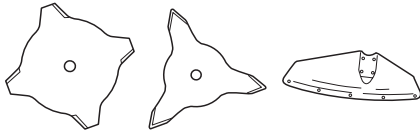

A trimmer head is intended for trimming grass.



General rules



Only use cutting attachments with the guards we recommend! See the chapter on Technical data.



Keep the teeth of the blade correctly sharpened! Follow our instructions and use the recommended file gauge. An incorrectly sharpened or damaged blade increases the risk of accidents.

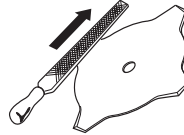

Keep the correct setting on the saw blade! Follow our instructions and use the recommended setting tool. An incorrectly set saw blade increases the risk of jamming and blade thrust, and damage to the saw blade.

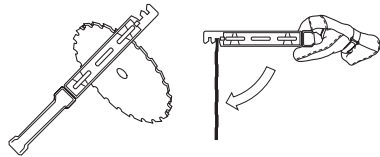

Check the cutting attachment for damage or cracks. A damaged cutting attachment should always be replaced.

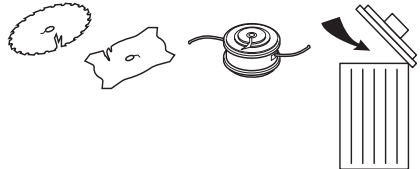

Sharpening grass cutters and grass blades



- See the cutting attachment packaging for correct sharpening instructions. Sharpen blades and cutters using a single-cut flat file.

GENERAL SAFETY PRECAUTIONS

- Sharpen all edges equally to maintain the balance of the blade.

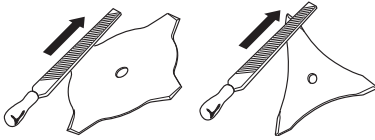

WARNING! Always discard a blade that is bent, twisted, cracked, broken or damaged in any other way. Never attempt to straighten a twisted blade so that it can be reused. Only use original blades of the specified type.

Sharpening the saw blade



- See the cutting attachment packaging for correct sharpening instructions.

A correctly sharpened blade is essential for working efficiently and to avoid unnecessary wear to the blade and clearing saw.



- Make sure that the blade is well supported when you file it. Use a 5.5 mm round file with a file holder.

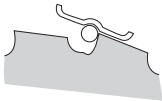

- The filing angle is 15°. File alternate teeth to the right and those in between to the left. If the blade has been heavily pitted by stones it may be necessary to dress the top edges of the teeth with a flat file, in exceptional cases. If so, this should be done before filing with a

round file. The top edges must be filed down by the same amount for all the teeth.

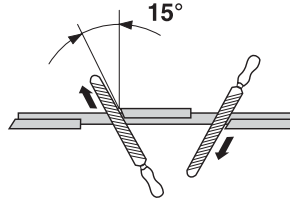

Adjust the blade setting. This should be 1 mm.

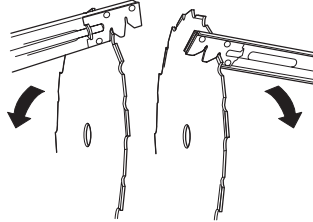

Trimmer head

IMPORTANT!

Always ensure the trimmer cord is wound tightly and evenly around the drum, otherwise the machine will generate harmful vibration.

- Only use the recommended trimmer heads and trimmer cords. These have been tested by the manufacturer to suit a particular engine size. This is especially important when a fully automatic trimmer head is used. Only use the recommended cutting attachment. See the chapter on Technical data.

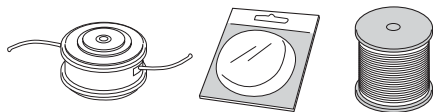

- Smaller machines generally require small trimmer heads and vice versa. This is because when clearing using a cord the engine must throw out the cord radially from the trimmer head and overcome the resistance of the grass being cleared.
- The length of the cord is also important. A longer cord requires greater engine power than a shorter cord of the same diameter.
- Make sure that the cutter on the trimmer guard is intact. This is used to cut the cord to the correct length.
- To increase the life of the cord it can be soaked in water for a couple of days. This will make the line tougher so that it lasts longer.

ASSEMBLY

Fitting the handlebar (323RII)



- Remove the screw at the rear of the throttle handle.
- Slide the throttle handle onto the right side of the handlebar, (see diagram).

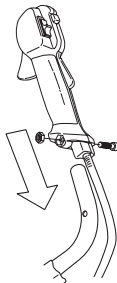

- Align the screw hole in the throttle handle with the hole in the handlebar.
- Refit the screw in the hole in the rear of the throttle handle.
- Screw the screw through the handle and handlebar. Tighten it.
- Unscrew the knob from the handlebar mounting.
- Position the handlebar as shown. Fit the mounting components and tighten the knob lightly.

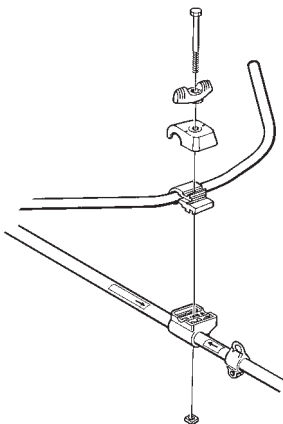

- Put on the harness and hang the machine from the support hook. Now make a final adjustment so that

the machine is in a comfortable working position when it hangs from the harness. Tighten the knob.



Fitting the handlebar (327Rx, 327RDx)



- Remove the screw at the rear of the throttle handle.
- Slide the throttle handle onto the right side of the handlebar, (see diagram).

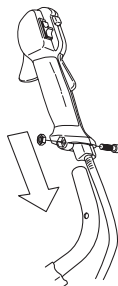

- Align the screw hole in the throttle handle with the hole in the handlebar.
- Refit the screw in the hole in the rear of the throttle handle.
- Screw the screw through the handle and handlebar. Tighten it.
- Unscrew the knob from the handlebar mounting.

ASSEMBLY

- Position the handlebar as shown. Fit the mounting components and tighten the knob lightly.

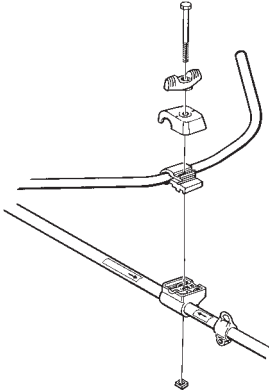

- Put on the harness and hang the machine from the support hook. Now make a final adjustment so that the machine is in a comfortable working position when it hangs from the harness. Tighten the knob.



Assembling and dismantling the two-piece shaft (327RDx)



Assembly

- Loosen the coupling by turning the knob.
- Align the tab of the attachment (A) with the arrow on the coupling (B).

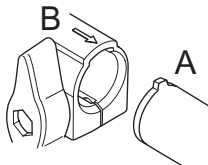

- Push the attachment into the coupling until the attachment snaps into place.

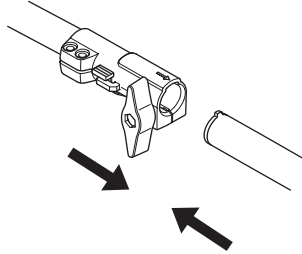

- Before using the unit, tighten the knob securely.

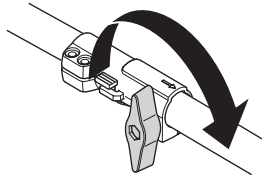

Dismantling

- Loosen the coupling by turning the knob (at least 3 times).

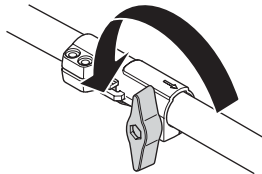

- Push and hold the button (C). While securely holding the engine end, pull the attachment straight out of the coupling.

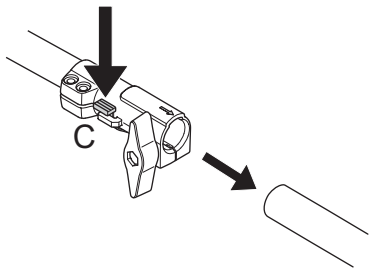

ASSEMBLY

Assembling the cutting equipment



WARNING!

When fitting the cutting attachment it is extremely important that the raised section on the drive disc/support flange engages correctly in the centre hole of the cutting attachment. If the cutting attachment is fitted incorrectly it can result in serious and/or fatal personal injury.

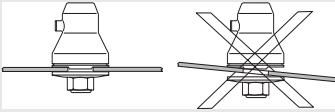

WARNING! Never use a cutting attachment without an approved guard. See the chapter on Technical data. If an incorrect or faulty guard is fitted this can cause serious personal injury.

IMPORTANT! If a saw blade or grass blade are to be used the machine must be equipped with the correct handlebar, blade guard and harness.

Fitting a blade guard, grass blade and grass cutter

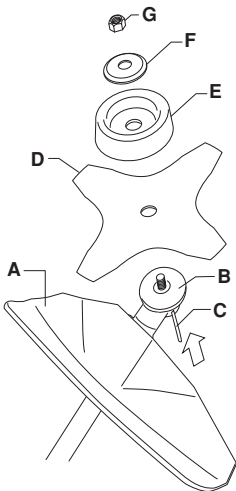

- Hook the blade guard/combination guard (A) onto the fitting on the shaft and secure with the bolt.

CAUTION! Use the recommended blade guard. See the Technical data section.

- Fit the drive disc (B) on the output shaft.
- Turn the blade shaft until one of the holes in the drive disc aligns with the corresponding hole in the gear housing.
- Insert the locking pin (C) in the hole to lock the shaft.
- Place the blade (D), support cup (E) and support flange (F) on the output shaft.
- Fit the nut (G). The nut must be tightened to a torque of 35-50 Nm (3.5-5 kpm). Use the socket spanner in the tool kit. Hold the shaft of the spanner as close to the blade guard as possible. To tighten the nut, turn the spanner in the opposite direction to the direction of rotation (Caution! left-hand thread).

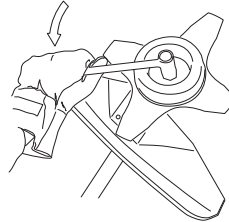

Fitting the blade guard and saw blade

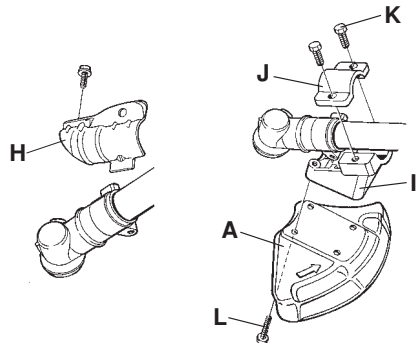

- Remove the mounting plate (H). Fit the adapter (I) and bracket (J) with the two screws (K) as shown. Fit the blade guard (A) to the adapter using the 4 screws (L) as shown.

ASSEMBLY

CAUTION! Use the recommended blade guard. See the Technical data section.

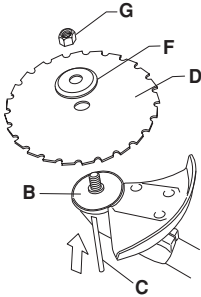

- Fit the drive disc (B) on the output shaft.
- Turn the blade shaft until one of the holes in the drive disc aligns with the corresponding hole in the gear housing.
- Insert the locking pin (C) in the hole to lock the shaft.
- Place the blade (D) and support flange (F) on the output shaft.
- Fit the nut (G). The nut must be tightened to a torque of 35-50 Nm (3.5-5 kpm). Use the socket spanner in the tool kit. Hold the shaft of the spanner as close to the blade guard as possible. To tighten the nut, turn the spanner in the opposite direction to the direction of rotation (Caution! left-hand thread).

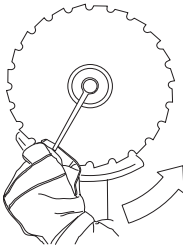

- When loosening and tightening the saw blade nut, there is a risk of injury from the teeth of the saw blade. You should therefore always ensure that your hand is shielded by the blade guard when doing this. Always use a socket spanner with a shaft that is long enough to allow this. The arrow in the diagram shows the area where you should operate the socket spanner when loosening or tightening the nut.

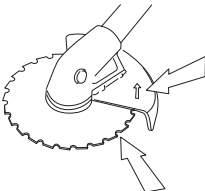

Fitting other guards and cutting attachments



- Fit the trimmer guard/combination guard (A) intended for use with the trimmer head/plastic blades. Hook the guard onto the fitting on the shaft and secure it with the bolt (L).

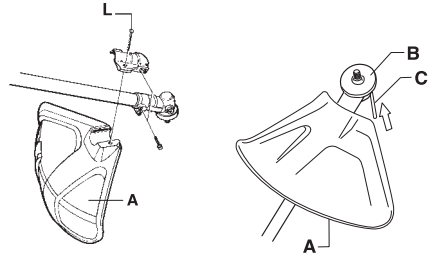

- Fit the drive disc (B) on the output shaft.
- Turn the blade shaft until one of the holes in the drive disc aligns with the corresponding hole in the gear housing.
- Insert the locking pin (C) in the hole to lock the shaft.
- Screw on the trimmer head/plastic blades (H) in the opposite direction to the direction of rotation.

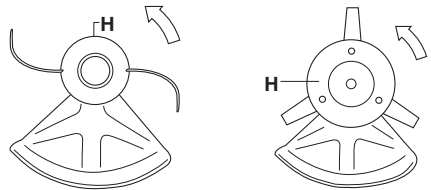

- To dismantle, follow the instructions in the reverse order.

ASSEMBLY

Adjusting the harness and clearing saw



WARNING! When using a clearing saw it must always be hooked securely to the harness. Otherwise you will be unable to control the clearing saw safely and this can result in injury to yourself or others. Never use a harness with a defective quick release.

Standard harness



Quick release

At the front is an easily accessible, quick release. Use this if the engine catches fire or in any other emergency situation that requires you to free yourself from the machine and harness.

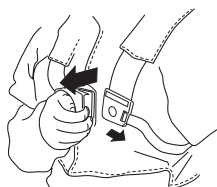

Spreading the load on your shoulders

A well-adjusted harness and machine makes work much easier. Adjust the harness for the best working position. Tension the side straps so that the weight is evenly distributed across both shoulders.



Correct height

Adjust the shoulder strap so that the cutting attachment is parallel to the ground.



Correct balance

Let the cutting attachment rest lightly on the ground. If you use a saw blade it should balance about 10 cm above the ground to prevent contact with stones and the like. Adjust the position of the suspension ring to balance the clearing saw correctly.



FUEL HANDLING

Fuel safety

Never start the machine:

- 1 If you have spilt fuel on it. Wipe off the spillage and allow remaining fuel to evaporate.
- 2 If you have spilt fuel on yourself or your clothes, change your clothes. Wash any part of your body that has come in contact with fuel. Use soap and water.
- 3 If the machine is leaking fuel. Check regularly for leaks from the fuel cap and fuel lines.

Transport and storage

- Store and transport the machine and fuel so that there is no risk of any leakage or fumes coming into contact with sparks or naked flames, for example, from electrical machinery, electric motors, electrical relays/ switches or boilers.
- When storing and transporting fuel always use approved containers intended for this purpose.
- When storing the machine for long periods the fuel tank must be emptied. Contact your local petrol station to find out where to dispose of excess fuel.
- Ensure the machine is cleaned and that a complete service is carried out before long-term storage.
- The transport guard must always be fitted to the cutting attachment when the machine is being transported or in storage.
- In order to prevent unintentional starting of the engine, the spark plug cap must always be removed during long-term storage, if the machine is not under close supervision and when performing all service measures.



WARNING! Take care when handling fuel. Bear in mind the risk of fire, explosion and inhaling fumes.

Fuel

CAUTION! The machine is equipped with a two-stroke engine and must always be run using a mixture of petrol and two-stroke engine oil. It is important to accurately measure the amount of oil to be mixed to ensure that the correct mixture is obtained. When mixing small amounts of fuel, even small inaccuracies can drastically affect the ratio of the mixture.



WARNING! Fuel and fuel fumes are highly inflammable and can cause serious injury when inhaled or allowed to come in contact with the skin. For this reason observe caution when handling fuel and make sure there is adequate ventilation.

Petrol



CAUTION! Always use a quality petrol/oil mixture at least 90 octane (RON). If your machine is equipped with a catalytic converter (see chapter on Technical data) always use a good quality unleaded petrol/oil mixture. Leaded petrol will destroy the catalytic converter.

Use low-emission petrol, also known as alkylate petrol, if it is available.

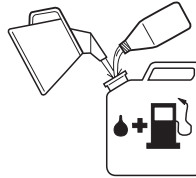

- The lowest octane recommended is 90 (RON). If you run the engine on a lower octane grade than 90 so-called knocking can occur. This gives rise to a high engine temperature, which can result in serious engine damage.
- When working at continuous high revs a higher octane rating is recommended.

Two-stroke oil

- For best results and performance use HUSQVARNA two-stroke engine oil, which is specially formulated for our air-cooled two-stroke engines.
- Never use two-stroke oil intended for water-cooled engines, sometimes referred to as outboard oil (rated TCW).
- Never use oil intended for four-stroke engines.
- A poor oil quality and/or too high oil/fuel ratio may jeopardise function and decrease the life time of catalytic converters.
- Mixing ratio
 - 1:50 (2%) with HUSQVARNA two-stroke oil.
 - 1:33 (3%) with oils class JASO FB or ISO EGB formulated for air-cooled, two-stroke engines.

Petrol, litre	Two-stroke oil, litre	
	2% (1:50)	3% (1:33)
5	0,10	0,15
10	0,20	0,30
15	0,30	0,45
20	0,40	0,60

FUEL HANDLING

Mixing

- Always mix the petrol and oil in a clean container intended for fuel.
- Always start by filling half the amount of the petrol to be used. Then add the entire amount of oil. Mix (shake) the fuel mixture. Add the remaining amount of petrol.
- Mix (shake) the fuel mixture thoroughly before filling the machine's fuel tank.



- Do not mix more than one month's supply of fuel at a time.
- If the machine is not used for some time the fuel tank should be emptied and cleaned.



WARNING! The catalytic converter muffler gets very hot during and after use. This also applies during idling. Be aware of the fire hazard, especially when working near flammable substances and/or vapours.

Fuelling



WARNING! Taking the following precautions, will lessen the risk of fire:

Do not smoke or place hot objects near fuel.

Always shut off the engine before refuelling.

Always stop the engine and let it cool for a few minutes before refuelling.

When refuelling, open the fuel cap slowly so that any excess pressure is released gently.

Tighten the fuel cap carefully after refuelling.

Always move the machine away from the refuelling area before starting.

- Always use a fuel container with an anti-spill valve.
- Clean the area around the fuel cap. Contamination in the tank can cause operating problems.
- Ensure that the fuel is well mixed by shaking the container before filling the tank.

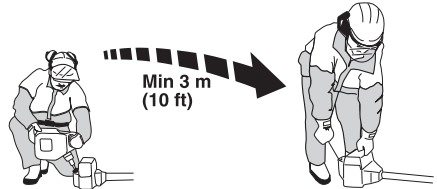

STARTING AND STOPPING

Check before starting



- Check the blade to ensure that no cracks have formed at the bottom of the teeth or by the centre hole. The most common reason why cracks are formed is that sharp corners have been formed at the bottom of the teeth while sharpening or that the blade has been used with dull teeth. Discard a blade if cracks are found.

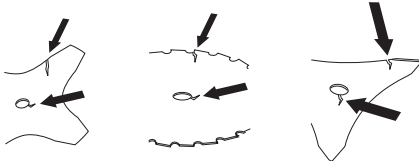

- Check that the support flange is not cracked due to fatigue or due to being tightened too much. Discard the support flange if it is cracked.

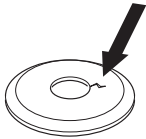

- Ensure the locking nut has not lost its captive force. The nut lock should have a locking force of at least 1.5 Nm. The tightening torque of the locking nut should be 35-50 Nm.



- Check that the blade guard is not damaged or cracked. Replace the blade guard if it is exposed to impact or is cracked.

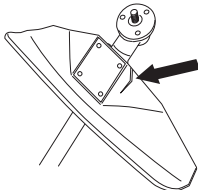

- Check that the trimmer head and trimmer guard are not damaged or cracked. Replace the trimmer head or

trimmer guard if they have been exposed to impact or are cracked.

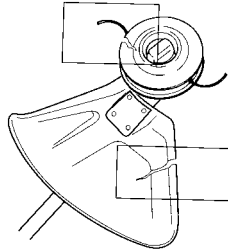

- Never use the machine without a guard nor with a defective guard.
- All covers must be correctly fitted and undamaged before you start the machine.

Starting and stopping



WARNING! The complete clutch cover and shaft must be fitted before the machine is started, otherwise the clutch can come loose and cause personal injury.

Always move the machine away from the refuelling area before starting. Place the machine on a flat surface. Ensure the cutting attachment cannot come into contact with any object.

Make sure no unauthorised persons are in the working area, otherwise there is a risk of serious personal injury. The safety distance is 15 metres.

Starting



Primer bulb: Press the air purge repeatedly until fuel begins to fill the bulb. The bulb need not be completely filled.

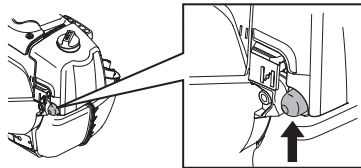

STARTING AND STOPPING

Choke: Set the choke control in the choke position.

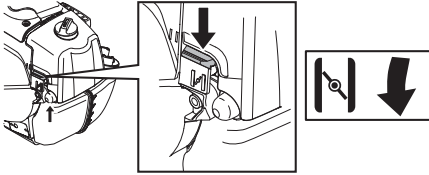

WARNING! When the engine is started with the choke in either the choke or start throttle positions the cutting attachment will start to rotate immediately.

Hold the body of the machine on the ground using your left hand (CAUTION! Not with your foot!). Grip the starter handle, slowly pull out the cord with your right hand until you feel some resistance (the starter pawls grip), now quickly and powerfully pull the cord. **Never twist the starter cord around your hand.**

Repeat pulling the cord until the engine starts. When the engine starts, return choke control to run position and apply full throttle; the throttle will automatically disengage from the start setting.

CAUTION! Do not pull the starter cord all the way out and do not let go of the starter handle when the cord is fully extended. This can damage the machine.



CAUTION! Do not put any part of your body in marked area. Contact can result in burns to the skin, or electrical shock if the spark plug cap has been damaged. Always use gloves. Do not use a machine with damaged spark plug cap.

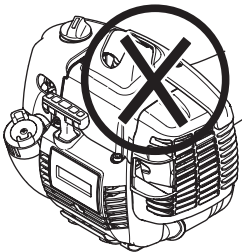

For throttle handles with a start throttle lock:

Set the throttle to the start position by first pressing the throttle lockout and the throttle trigger, then pressing the start throttle button (A). Then release the throttle lockout and the throttle trigger, followed by the start throttle button. The throttle function is now activated. To return the engine to idle, press the throttle lockout and throttle trigger again.

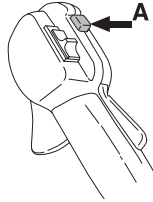

Stopping



Stop the engine by switching off the ignition.

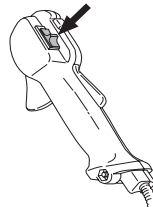

CAUTION! The stop switch automatically returns to the start position. In order to prevent unintentional starting, the spark plug cap must be removed from the spark plug when assembling, checking and/or performing maintenance.

WORKING TECHNIQUES

General working instructions

IMPORTANT!

This section describes the basic safety precautions for working with clearing saws and trimmers.

If you encounter a situation where you are uncertain how to proceed you should ask an expert. Contact your dealer or your service workshop.

Avoid all usage which you consider to be beyond your capability.

You must understand the difference between forestry clearing, grass clearing and grass trimming before use.

Basic safety rules



1 Look around you:

- To ensure that people, animals or other things cannot affect your control of the machine.
 - To ensure that people, animals, etc., do not come into contact with the cutting attachment or loose objects that are thrown out by the cutting attachment.
- CAUTION! Do not use the machine unless you are able to call for help in the event of an accident.
- ### 2 Inspect the working area. Remove all loose objects, such as stones, broken glass, nails, steel wire, string, etc. that could be thrown out or become wrapped around the cutting attachment.
- ### 3 Do not use the machine in bad weather, such as dense fog, heavy rain, strong wind, intense cold, etc. Working in bad weather is tiring and often brings added risks, such as icy ground, unpredictable felling direction, etc.
- ### 4 Make sure you can move and stand safely. Check the area around you for possible obstacles (roots, rocks, branches, ditches, etc.) in case you have to move suddenly. Take great care when working on sloping ground.



- ### 5 Take great care when cutting a tree that is in tension. A tree that is in tension may spring back to its normal position before or after being cut. If you position yourself incorrectly or make the cut in the wrong place the tree may hit you or the machine and cause you to lose control. Both situations can cause serious personal injury.

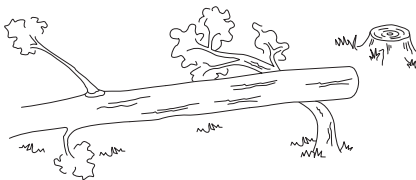

- ### 6 Keep a good balance and a firm foothold.

- ### 7 Always hold the machine with both hands. Hold the machine on the right side of your body.



- ### 8 Keep the cutting attachment below waist level.
- ### 9 Switch off the engine before moving to another area. Fit the transport guard before carrying or transporting the equipment any distance.
- ### 10 Never put the machine down with the engine running unless you have it in clear sight.

WORKING TECHNIQUES

The ABC of clearing

- Always use the correct equipment.
- Make sure the equipment is well adjusted.
- Follow the safety precautions.
- Organise your work carefully.
- Always use full throttle when starting to cut with the blade.
- Always use sharp blades.
- Avoid stones.
- Control the felling direction (take advantage of the wind).



WARNING! Neither the operator of the machine nor anyone else may attempt to remove the cut material while the engine is running or the cutting equipment is rotating, as this can result in serious injury.

Stop the engine and cutting equipment before you remove material that has wound around the blade shaft as otherwise there is a risk of injury. The bevel gear can get hot during use and may remain so for a while afterwards. You could get burnt if you touch it.



WARNING! Watch out for thrown objects. Always wear approved eye protection. Never lean over the cutting attachment guard. Stones, rubbish, etc. can be thrown up into the eyes causing blindness or serious injury.

Keep unauthorised persons at a distance. Children, animals, onlookers and helpers should be kept outside the safety zone of 15 m. Stop the machine immediately if anyone approaches. Never swing the machine around without first checking behind you to make sure none is within the safety zone.



WARNING! Sometimes branches or grass get caught between the guard and cutting attachment. Always stop the engine before cleaning.

Working methods



WARNING! Machines fitted with saw blades or grass blades can be thrown violently to the side when the blade comes into contact with a fixed object. This is called blade thrust. A blade thrust can be violent enough to cause the machine and/or operator to be propelled in any direction, and possibly lose control of the machine. Blade thrust can occur without warning if the machine snags, stalls or binds. Blade thrust is more likely to occur in areas where it is difficult to see the material being cut.

Avoid cutting with the area of the blade between the 12 o'clock and 3 o'clock positions. Because of the speed of rotation of the blade, blade thrust can occur if you attempt to cut thick stems with this area of the blade.

- Before you start clearing, check the clearing area, the type of terrain, the slope of the ground, whether there are stones, hollows etc.
- Start at whichever end of the area is easiest, and clear an open space from which to work.
- Work systematically to and fro across the area, clearing a width of around 4-5 m on each pass. This exploits the full reach of the machine in both directions and gives the operator a convenient and varied working area to work in.

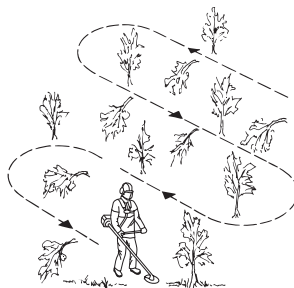

- Clear a strip around 75 m long. Move your fuel can as work progresses.
- On sloping ground you should work along the slope. It is much easier to work along a slope than it is to work up and down it.
- You should plan the strip so that you avoid going over ditches or other obstacles on the ground. You should also orient the strip to take advantage of wind

WORKING TECHNIQUES

conditions, so that cleared stems fall in the cleared area of the stand.



Forestry clearing using a saw blade



- The risk of blade thrust increases with increasing stem size. You should therefore avoid cutting with the area of the blade between 12 o'clock and 3 o'clock.

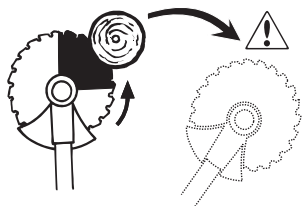

- To fell to the left, the bottom of the tree should be pushed to the right. Tilt the blade and bring it diagonally down to the right, exerting firm pressure. At the same time push the stem using the blade guard. Cut with the area of the blade between 3 o'clock and 5 o'clock. Apply full throttle before advancing the blade.

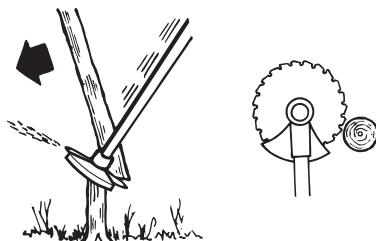

- To fell to the right, the bottom of the tree should be pushed to the left. Tilt the blade and bring it diagonally up to the right. Cut with the area of the blade between

3 o'clock and 5 o'clock so that the direction of rotation of the blade pushes the bottom of the tree to the left.

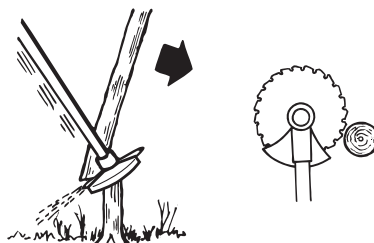

- To fell a tree forwards, the bottom of the tree should be pulled backwards. Pull the blade backwards with a quick, firm movement.

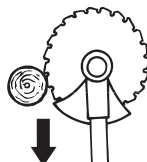

- Large stems must be cut from two sides. First determine which direction the stem will fall. Make the first cut on the felling side. Then finish cutting the stem from the other side. Adjust the cutting pressure to match the size of the stem and the hardness of the wood. Small stems require more pressure, while large stems require less pressure.

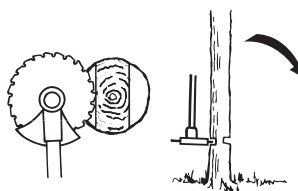
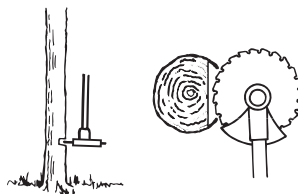

- If the stems are tightly packed, adapt your walking pace to suit.
- If the blade jams in a stem, never jerk the machine free. If you do this the blade, bevel gear, shaft or handlebar may be damaged. Release the handles, grip the shaft with both hands and gently pull the machine free.

WORKING TECHNIQUES

Brush cutting with a saw blade



- Thin stems and brush are mown down. Work with a sawing movement, swinging sideways.
- Try to cut several stems in a single sawing movement.
- With groups of hardwood stems, first clear around the group. Start by cutting the stems high up around the outside of the group to avoid jamming. Then cut the stems to the required height. Now try to reach in with the blade and cut from the centre of the group. If it is still difficult to gain access, cut the stems high up and let them fall. This will reduce the risk of jamming.

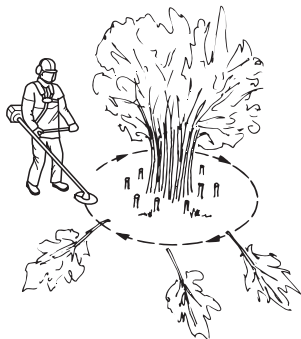

Grass clearing using a grass blade



- Grass blades and grass cutters must not be used on woody stems.
- A grass blade is used for all types of tall or coarse grass.
- The grass is cut down with a sideways, swinging movement, where the movement from right-to-left is the clearing stroke and the movement from left-to-right is the return stroke. Let the left-hand side of the blade (between 8 and 12 o'clock) do the cutting.

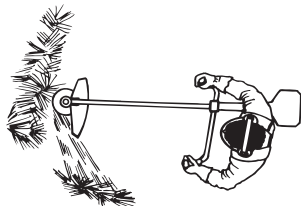

- If the blade is angled to the left when clearing grass, the grass will collect in a line, which makes it easier to collect, e.g. by raking.

- Try to work rhythmically. Stand firmly with your feet apart. Move forward after the return stroke and stand firmly again.
- Let the support cup rest lightly against the ground. It is used to protect the blade from hitting the ground.
- Reduce the risk of material wrapping around the blade by following these instructions:
 - 1 Always work at full throttle.
 - 2 Avoid the previously cut material during the return stroke.
- Stop the engine, unclip the harness and place the machine on the ground before you start to collect the cut material.

Grass trimming with a trimmer head



Trimming

- Hold the trimmer head just above the ground at an angle. It is the end of the cord that does the work. Let the cord work at its own pace. Never press the cord into the area to be cut.

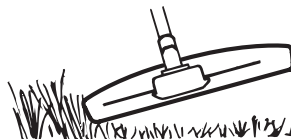

- The cord can easily remove grass and weeds up against walls, fences, trees and borders, however it can also damage sensitive bark on trees and bushes, and damage fence posts.
- Reduce the risk of damaging plants by shortening the cord to 10-12 cm and reducing the engine speed.

Clearing

- The clearing technique removes all unwanted vegetation. Keep the trimmer head just above the ground and tilt it. Let the end of the cord strike the ground around trees, posts, statues and the like. **CAUTION!** This technique increases the wear on the cord.

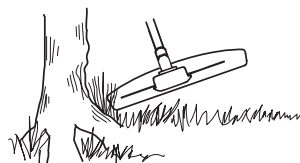

- The cord wears quicker and must be fed forward more often when working against stones, brick, concrete, metal fences, etc., than when coming into contact with trees and wooden fences.
- When trimming and clearing you should use less than full throttle so that the cord lasts longer and to reduce the wear on the trimmer head.

WORKING TECHNIQUES

Cutting

- The trimmer is ideal for cutting grass that is difficult to reach using a normal lawn mower. Keep the cord parallel to the ground when cutting. Avoid pressing the trimmer head against the ground as this can ruin the lawn and damage the tool.

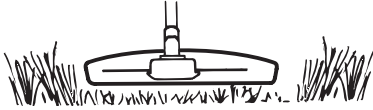

- Do not allow the trimmer head to constantly come into contact with the ground during normal cutting. Constant contact of this type can cause damage and wear to the trimmer head.

Sweeping

- The fan effect of the rotating cord can be used for quick and easy clearing up. Hold the cord parallel to and above the area to be swept and move the tool to and fro.

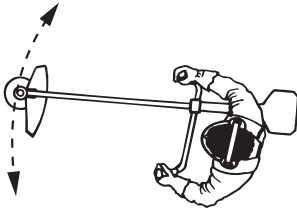

- When cutting and sweeping you should use full throttle to obtain the best results.

MAINTENANCE

Carburettor

Your Husqvarna product has been designed and manufactured to specifications that reduce harmful emissions. After the engine has used 8-10 tanks of fuel the engine will be run-in. To ensure that it continues to run at peak performance and to minimise harmful exhaust emissions after the running-in period, ask your dealer/ service workshop (who will have a rev counter at their disposal) to adjust your carburettor.



WARNING! The complete clutch cover and shaft must be fitted before the machine is started, otherwise the clutch can come loose and cause personal injury.

Function



- The carburettor governs the engine's speed via the throttle control. Air and fuel are mixed in the carburettor. The air/fuel mixture is adjustable. Correct adjustment is essential to get the best performance from the machine.
- Adjusting the carburettor means that the engine is adapted to local operating conditions, e.g. climate, altitude, petrol and the type of 2-stroke oil.
- The carburettor has three adjustment controls:
L = Low speed jet
H = High speed jet
T = Idle adjustment screw

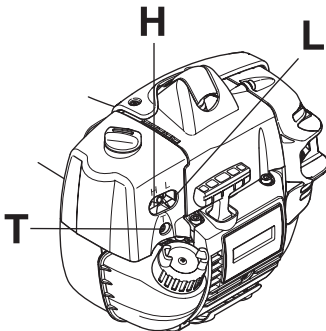

- The L and H-jets are used to adjust the supply of fuel to match the rate that air is admitted, which is controlled with the throttle. If they are screwed clockwise the air/fuel ratio becomes leaner (less fuel) and if they are turned anti-clockwise the ratio becomes richer (more fuel). A lean mixture gives a higher engine speed and a rich mixture gives a lower engine speed.

- The T-screw regulates the throttle setting at idle speed. If the T-screw is turned clockwise this gives a higher idle speed; turning it anti-clockwise gives a lower idle speed.

Basic setting

- The basic carburettor settings are adjusted during testing at the factory. The basic setting is richer than the optimal setting and should be maintained for the first few hours the machine is in use. The carburettor should then be finely adjusted. Fine adjustment should be carried out by a skilled technician.

CAUTION! If the cutting attachment rotates when the engine is idling the idle adjustment screw T should be turned anti-clockwise until the cutting attachment stops.

Rec. idle speed: 2700 rpm

Recommended max. speed: See the Technical data section.



WARNING! If the idle speed cannot be adjusted so that the cutting attachment stops, contact your dealer/service workshop. Do not use the machine until it has been correctly adjusted or repaired.

Fine adjustment

- When the machine has been "run-in" the carburettor should be finely adjusted. The fine adjustment should be carried out by a qualified person. First adjust the L-jet, then the idling screw T and then the H-jet.

Conditions

- Before any adjustments are made, make sure that the air filter is clean and the air filter cover is fitted. If you adjust the carburettor when the air filter is dirty it will result in a leaner mixture when the filter is finally cleaned. This can lead to serious engine damage.
- Carefully turn both jets, L and H, so that they are midway between fully screwed in and fully screwed out.
- Do not attempt to adjust the L and H jets beyond either stop as this could cause damage.
- Now start the machine according to the starting instructions and let it warm up for 10 minutes.

CAUTION! If the cutting attachment rotates when the engine is idling the idle adjustment screw T should be turned anti-clockwise until the cutting attachment stops.

MAINTENANCE

Low speed jet L

Try to find the highest idle speed by turning the low speed jet L clockwise then anti-clockwise. When the highest speed has been found, turn the low speed jet L 1/4 turn anti-clockwise.

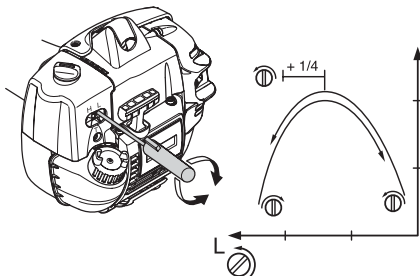

CAUTION! If the cutting attachment rotates when the engine is idling the idle adjustment screw T should be turned anti-clockwise until the cutting attachment stops.

Fine adjustment of the idle speed T

Adjust the idle speed using the idle adjustment screw T, if it is necessary to readjust. First turn the idle adjustment screw T clockwise until the cutting attachment starts to rotate. Then turn the screw anticlockwise until the cutting attachment stops. The idle speed is correctly adjusted when the engine will run smoothly in every position. The idle speed should also be well below the speed at which the cutting attachment starts to rotate.

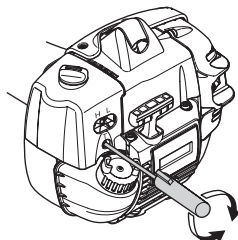

WARNING! If the idle speed cannot be adjusted so that the cutting attachment stops, contact your dealer/service workshop. Do not use the machine until it has been correctly adjusted or repaired.

High speed jet H

The high speed jet H affects the engine power, speed, temperature and fuel consumption. If the high speed jet H is set too lean (screwed in too far) the engine speed will be too high and cause engine damage. Do not let the engine run at full speed for more than 10 seconds.

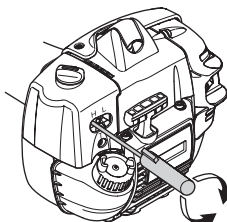

Apply full throttle and turn the high speed jet H very slowly clockwise until the engine slows down. Then turn the high speed jet H very slowly anticlockwise until the engine starts to run unevenly. Now turn the high speed jet H slowly clockwise a little way until the engine runs smoothly.

Note that the engine should not be under load when you adjust the high speed jet H. You should therefore remove the cutting attachment, nut, support flange and drive disc before adjusting the high speed jet H.

The high speed jet H is adjusted correctly when the machine burbles a little. If the machine races then the setting is too lean. If the engine produces a lot of smoke and burbles a lot then the setting is too rich.

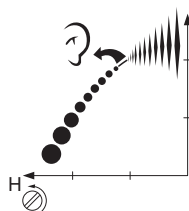

CAUTION! For optimum adjustment of the carburettor, contact a qualified dealer/service workshop that has a revolution counter at their disposal.

Correctly adjusted carburettor

When the carburettor is correctly adjusted the machine will accelerate without hesitation and burble a little at maximum speed. It is also important that the cutting attachment does not rotate at idle. If the low speed jet L is set too lean it may cause starting difficulties and poor acceleration.

If the high speed jet H is set too lean it will result in less power, less performance, poor acceleration and/or damage to the engine.

If both the L and H jets are set too rich it will result in acceleration problems or too low a working speed.

MAINTENANCE

Adjusting the start throttle speed

The correct start throttle speed is set by means of an adjuster on the rear of the handle next to the cable. Use this screw (4 mm Allen screw) to increase or decrease the start throttle speed.

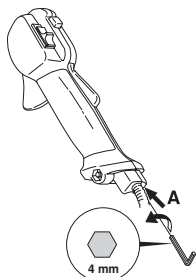

Proceed as follows:

- 1 Run the machine at idle.
- 2 Press the start throttle lock as described under the heading Starting and stopping.
- 3 If the start throttle speed is too low (below 4000 rpm), turn the adjuster screw A clockwise until the cutting attachment starts to rotate. Then turn A clockwise a further 1/2 turn.
- 4 If the start throttle speed is too high, turn the adjuster screw A anticlockwise until the cutting attachment stops. Then turn adjuster screw A clockwise a further 1/2 turn.



WARNING! If the idle speed cannot be adjusted so that the cutting attachment stops, contact your dealer/service workshop. Do not use the machine until it has been correctly adjusted or repaired.

Muffler



CAUTION! Some mufflers are fitted with a catalytic converter. See chapter on Technical data to see whether your machine is fitted with a catalytic converter.

The muffler is designed to reduce the noise level and to direct the exhaust gases away from the operator. The exhaust gases are hot and can contain sparks, which may cause fire if directed against dry and combustible material.

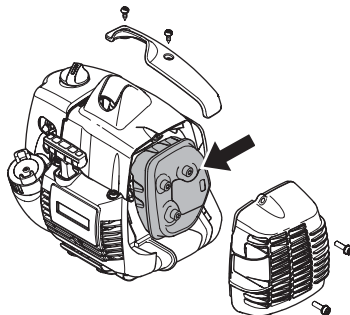

Some mufflers are equipped with a special spark arrestor mesh. If your machine has this type of muffler, you should clean the mesh at least once a week. This is best done with a wire brush. On mufflers without a catalytic converter the mesh should be cleaned weekly, or replaced if necessary. On mufflers fitted with a catalytic converter the mesh should be checked, and if necessary cleaned, monthly. **If the mesh is damaged it should be replaced.** If the mesh is frequently blocked, this can be a sign that the performance of the catalytic converter is impaired. Contact your dealer to inspect the muffler. A blocked mesh will cause the machine to overheat and result in damage to the cylinder and piston.

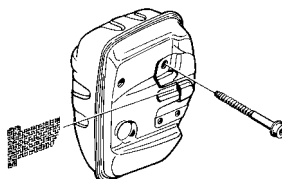

CAUTION! Never use a machine with a defective muffler.



WARNING! Mufflers fitted with catalytic converters get very hot during use and remain so for some time after stopping. This also applies at idle speed. Contact can result in burns to the skin. Remember the risk of fire!

MAINTENANCE

Cooling system



To keep the working temperature as low as possible the machine is equipped with a cooling system.

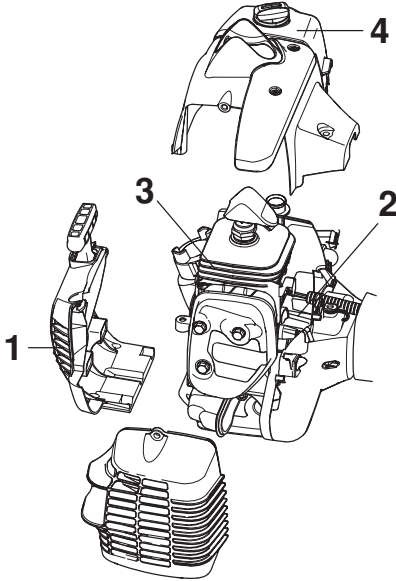

The cooling system consists of:

- 1 Air intake on the starter.
- 2 Fins on the flywheel.
- 3 Cooling fins on the cylinder.
- 4 Cylinder cover (directs cold air over the cylinder).

Clean the cooling system with a brush once a week, more often in demanding conditions. A dirty or blocked cooling system results in the machine overheating which causes damage to the piston and cylinder.

Bevel gear

The bevel gear is filled with the right quantity of grease at the factory. However, before using the machine you should check that the bevel gear is filled three-quarters full with grease. Use HUSQVARNA special grease.

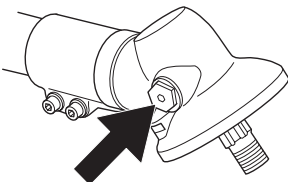

The grease in the bevel gear does not normally need to be changed except if repairs are carried out.

Air filter

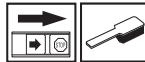

The air filter must be regularly cleaned to remove dust and dirt in order to avoid:

- Carburettor malfunctions
- Starting problems
- Loss of engine power
- Unnecessary wear to engine parts.
- Excessive fuel consumption.

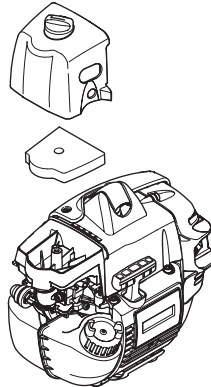

Clean the filter every 25 hours, or more regularly if conditions are exceptionally dusty.

Cleaning the air filter

Remove the air filter cover and take out the filter. Wash it clean in warm, soapy water. Ensure that the filter is dry before refitting it.

An air filter that has been in use for a long time cannot be cleaned completely. The filter must therefore be replaced with a new one at regular intervals. **A damaged air filter must always be replaced.**

If the machine is used in dusty conditions the air filter should be soaked in oil. See instructions under the heading Oiling the air filter.

MAINTENANCE

Oiling the air filter



Always use HUSQVARNA filter oil, art. no. 531 00 92-48. The filter oil contains a solvent to make it spread evenly through the filter. You should therefore avoid skin contact. Put the filter in a plastic bag and pour the filter oil over it. Knead the plastic bag to distribute the oil. Squeeze the excess oil out of the filter inside the plastic bag and pour off the excess before fitting the filter to the machine. Never use common engine oil. This would drain through the filter quite quickly and collect in the bottom.

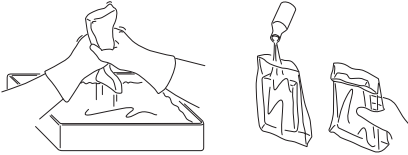

Two-piece shaft (327RDx)



The drive shaft end in the lower shaft should be lubricated with grease every 30 hours. There is a risk that the drive shaft ends (splined coupling) on models with two-piece shafts will seize if they are not lubricated regularly.

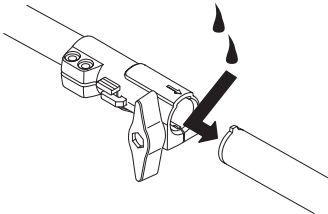

Spark plug



The spark plug condition is influenced by:

- Incorrect carburettor adjustment.
- An incorrect fuel mixture (too much or incorrect type of oil).
- A dirty air filter.

These factors cause deposits on the spark plug electrodes, which may result in operating problems and starting difficulties.

If the machine is low on power, difficult to start or runs poorly at idle speed: always check the spark plug first before taking any further action. If the spark plug is dirty, clean it and check that the electrode gap is 0.5 mm. The spark plug should be replaced after about a month in operation or earlier if necessary.

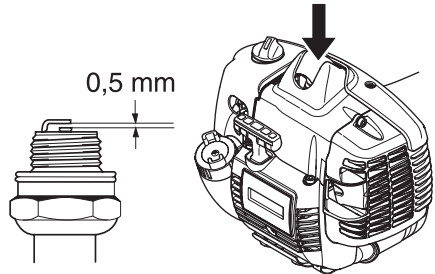

CAUTION! Always use the recommended spark plug type! Use of the wrong spark plug can damage the piston/cylinder.

MAINTENANCE

Maintenance schedule

The following is a list of the maintenance that must be performed on the machine. Most of the items are described in the Maintenance section. The user must only carry out the maintenance and service work described in this Operator's Manual. More extensive work must be carried out by an authorised service workshop.

Maintenance	Daily maintenance	Weekly maintenance	Monthly maintenance
Clean the outside of the machine.	X		
Check that the harness is not damaged.	X		
Check that the suspension ring is not damaged.	X		
Make sure the throttle trigger lock and the throttle function correctly from a safety point of view.	X		
Check that the stop switch works correctly.	X		
Check that the handle and handlebar are undamaged and secured correctly.	X		
Check that the cutting attachment does not rotate at idle.	X		
Clean the air filter. Replace if necessary.	X		
Check that the guard is undamaged and not cracked. Replace the guard if it has been exposed to impact or is cracked.	X		
Check that the blade is correctly centred, is sharp, and is not cracked. An off-centre blade will cause vibration that could result in damage to the machine.	X		
Check that the trimmer head is undamaged and not cracked. Replace the trimmer head if necessary.	X		
Check that the locking nut of the cutting equipment is tightened correctly.	X		
Check that nuts and screws are tight.	X		
Check that there are no fuel leaks from the engine, tank or fuel lines.	X		
Check that the transport guard for the blade is intact and that it can be secured correctly.	X		
Check the starter and starter cord.		X	
Check that the vibration damping elements are not damaged.		X	
Clean the outside of the spark plug. Remove it and check the electrode gap. Adjust the gap to 0.5 mm or replace the spark plug. Check that the spark plug is fitted with a suppressor.		X	
Clean the machine's cooling system.		X	
Clean or replace the spark arrester mesh on the muffler (only applies to mufflers without a catalytic converter).		X	
Clean the outside of the carburettor and the space around it.		X	
Check that the bevel gear is filled three-quarters full with lubricant. Fill if necessary using special grease.		X	
Check the fuel filter from contamination and the fuel hose from cracks or other defects. Replace if necessary.			X
Check all cables and connections.			X
Check the clutch, clutch springs and the clutch drum for wear. Replace if necessary by an authorized service workshop.			X
Replace the spark plug. Check that the spark plug is fitted with a suppressor.			X
Check and clean the spark arrester mesh on the muffler (only applies to mufflers fitted with a catalytic converter).			X

TECHNICAL DATA

Technical data

Technical data	323RII	327Rx	327RDx
Engine			
Cylinder displacement, cm ³	24,5	24,5	24,5
Cylinder bore, mm	34	34	34
Stroke, mm	27	27	27
Idle speed, rpm	2700	2700	2700
Recommended max. fast idle speed, rpm	11000-11700	11000-11700	11000-11700
Speed of output shaft, rpm	9300	9300	9300
Max. engine output, acc. to ISO 8893, kW/ rpm	0,9/8400	0,9/8400	0,9/8400
Catalytic converter muffler	Yes	Yes	Yes
Speed-regulated ignition system	Yes	Yes	Yes
Ignition system			
Manufacturer/type of ignition system	Walbro MB	Walbro MB	Walbro MB
Spark plug	Champion RCJ 6Y	Champion RCJ 6Y	Champion RCJ 6Y
Electrode gap, mm	0,5	0,5	0,5
Fuel and lubrication system			
Manufacturer/type of carburettor	Zama C1Q	Zama C1Q	Zama C1Q
Fuel tank capacity, litre	0,5	0,5	0,5
Weight			
Weight without fuel, cutting attachment and guard, kg	5,1	5,4	5,6
Noise emissions			
(see note 1)			
Sound power level, measured dB(A)	109	109	109
Sound power level, guaranteed L _{WA} dB(A)	110	110	110
Noise levels			
(see note 2)			
Equivalent noise pressure level at the operator's ear, measured according to EN ISO 22868, dB(A), min./max.:	92/94	94/96	94/96
Vibration levels			
Vibration levels at handles, measured according to EN ISO 22867, m/s ²			
At idle, left/right handles, min.:	2,1/2,0	1,7/1,9	1,7/1,9
At idle, left/right handles, max.:	2,7/2,8	2,0/2,1	2,0/2,1
At max. speed, left/right handles, min.:	3,2/2,8	2,4/1,8	2,4/1,8
At max. speed, left/right handles, max.:	4,8/4,4	4,5/4,4	4,5/4,4

Note 1: Noise emissions in the environment measured as sound power (L_{WA}) in conformity with EC directive 2000/14/EC.

Note 2: Equivalent sound pressure level is calculated as the time-weighted energy total for sound pressure levels under various working conditions with the following time distribution: 1/2 idling and 1/2 max speed.

NOTE! The noise pressure level at operator's ear and vibrations on the handles are measured with all the approved cutting attachments for the machine. The table indicates the lowest and highest values.

TECHNICAL DATA

Approved accessories	Type	Cutting attachment guard, Art. no.
Centre hole in blades/cutters, Ø 25,4 mm		
Blade shaft thread M10		
Grass blade/grass cutter	Grass 255-4 1" (Ø 255 4-teeth)	503 93 42-02
	Grass 255-8 1" (Ø 250 8-teeth)	503 93 42-02
Saw blade	Scarlet 200-22 1" (Ø 200 22 teeth)	537 02 21-01
Plastic blades	Tricut Ø 300 mm	503 93 42-02 / 503 97 71-01
Trimmer head	T25	503 93 42-02 / 503 97 71-01
	S35	503 93 42-02 / 503 97 71-01
	T35, T35x	503 93 42-02 / 503 97 71-01
Support cup	Fixed	-

EC-declaration of conformity (Applies to Europe only)

We, **Husqvarna AB**, SE-561 82 Huskvarna, Sweden, tel: +46-36-146500, declare that the clearing saws **Husqvarna 323RII, 327RX and 327RDX** with serial numbers dating from 2008 onwards (the year is clearly stated on the rating plate, followed by the serial number), comply with the requirements of the COUNCIL'S DIRECTIVE:

- of June 22, 1998 "relating to machinery" **98/37/EC**, annex IIA.
- of December 15, 2004 "relating to electromagnetic compatibility" **2004/108/EC**.
- of May 8, 2000 "relating to the noise emissions in the environment" **2000/14/EC**. Conformity assessment according to Annex V. For information relating to noise emissions, see the chapter Technical data.

The following standards have been applied: **EN ISO 12100-2, CISPR 12:2005, EN ISO 11806**

SMP Svensk Maskinprovning AB, Fyrisborgsgatan 3, SE-754 50 Uppsala, Sweden, has performed voluntary type examination on behalf of Husqvarna AB. The certificates are numbered: **SEC/08/1228, 01/164/064 - 327RX/RDX, SEC/08/1229, 01/164/064 - 323RII**

Huskvarna February 13, 2008



Michael Kullberg, Business manager

Tri Cut

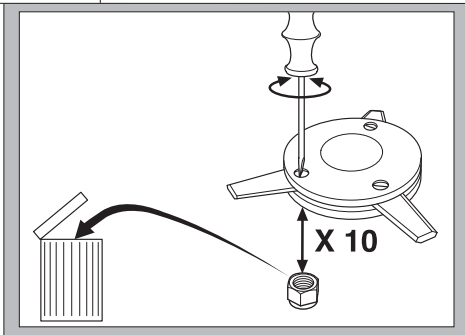
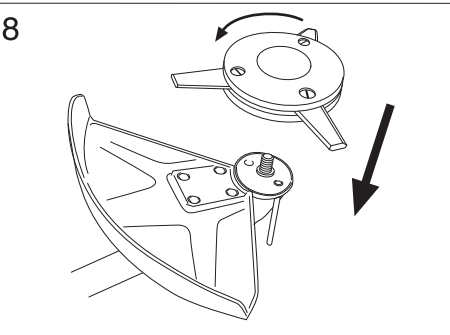
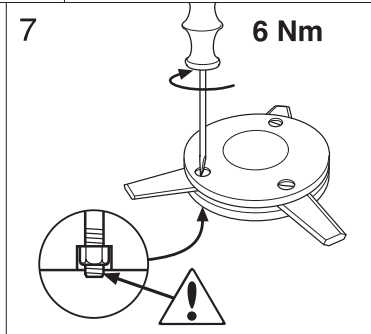
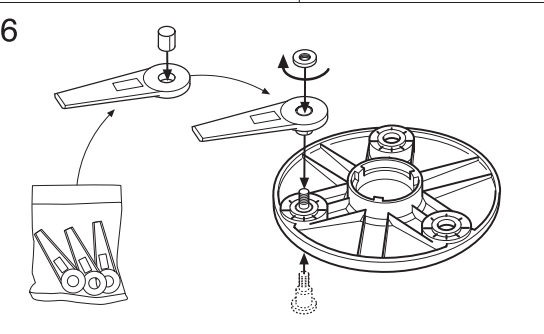
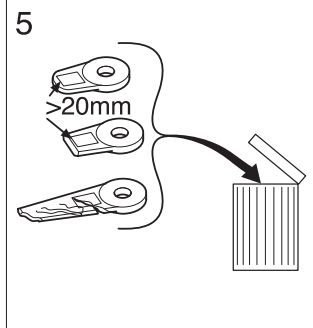
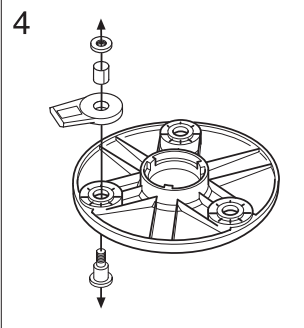
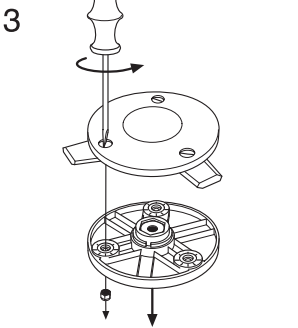
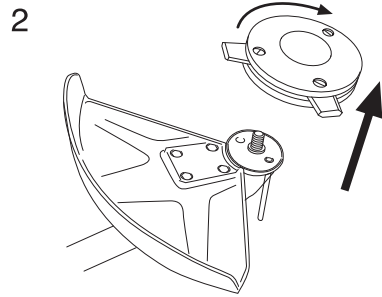
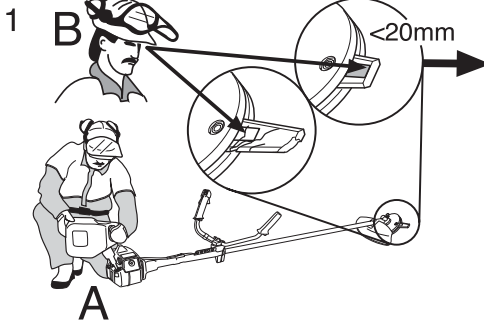

S35



1

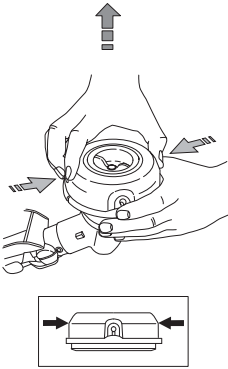

2

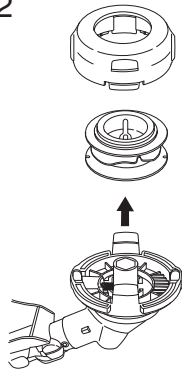

3

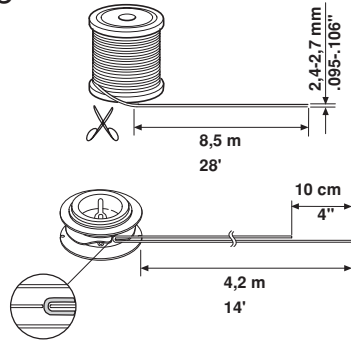

4

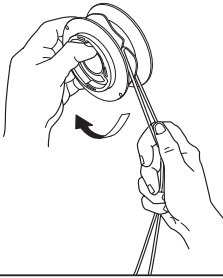

5

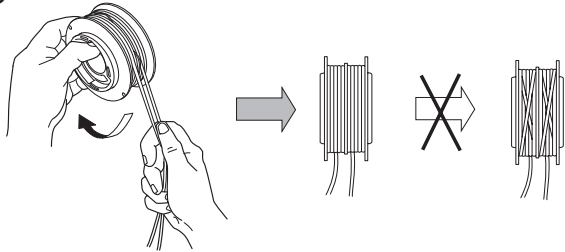

6

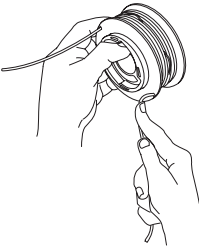

7

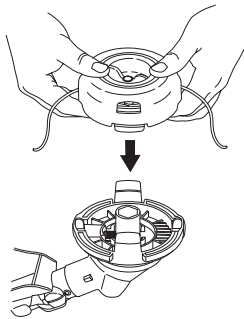

8

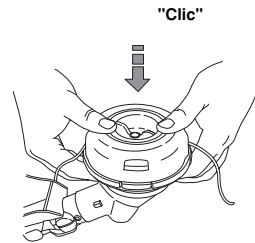

10

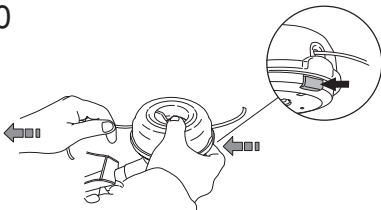

11

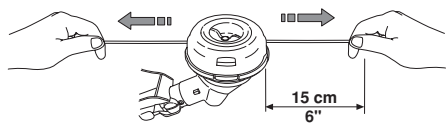

S35



1

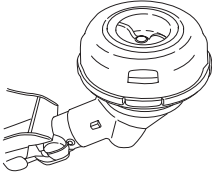

2

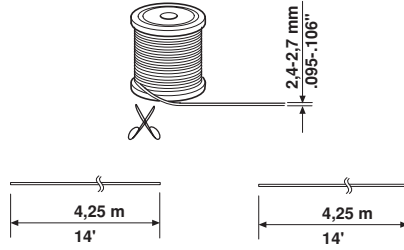

3

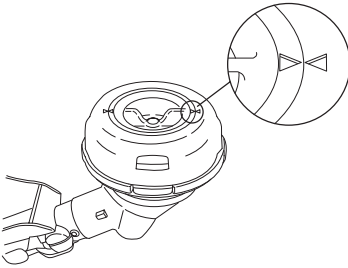

4

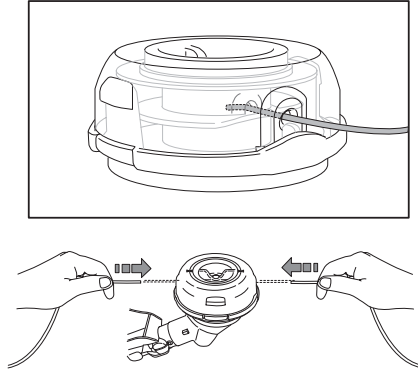

5

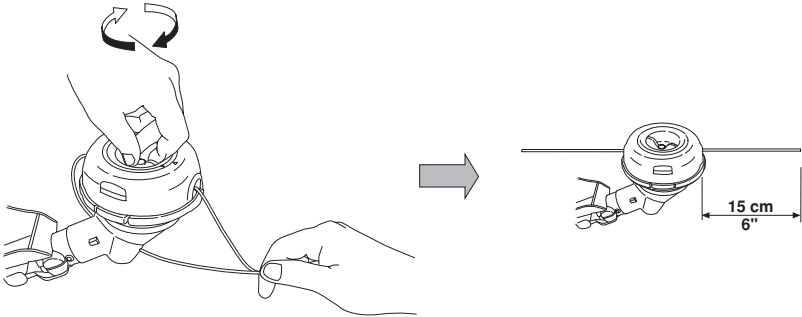

A

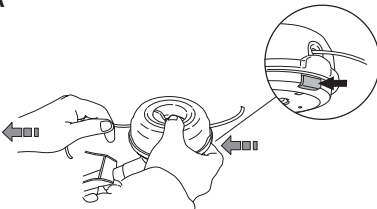

B

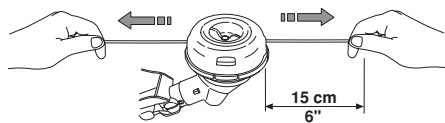

T35, T35x



1

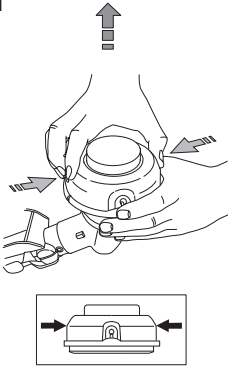

2

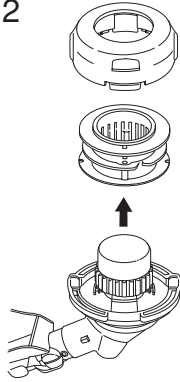

3

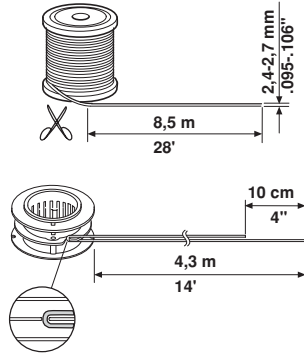

4

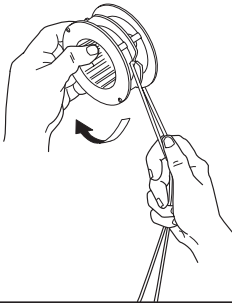

5

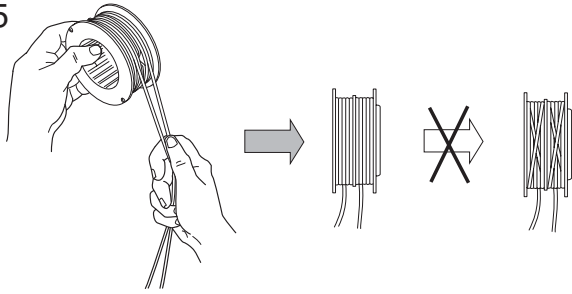

6

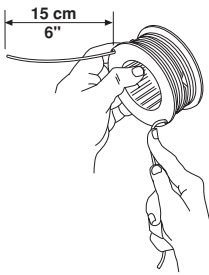

7

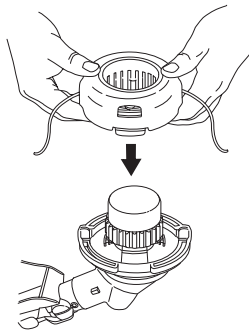

8

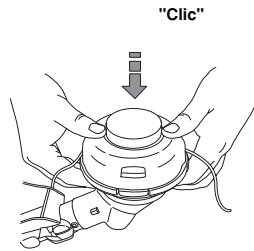

9

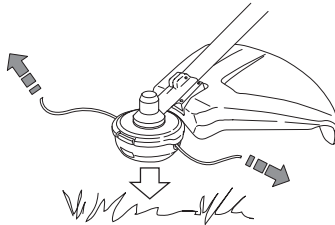

T25



1

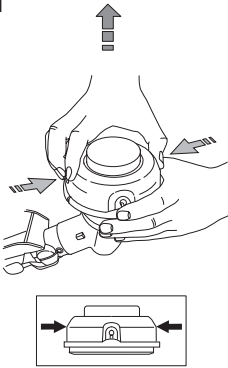

2

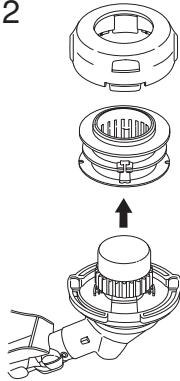

3

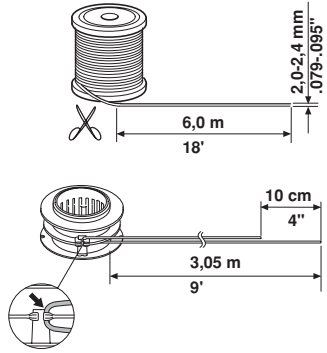

4

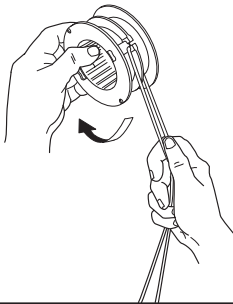

5

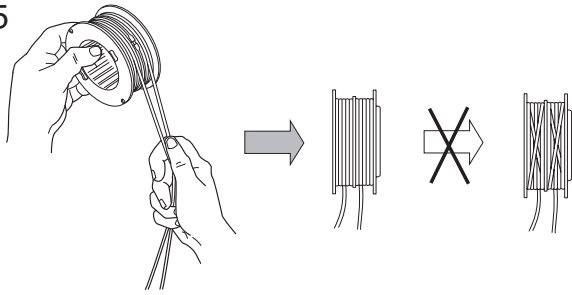

6

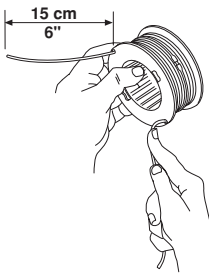

7

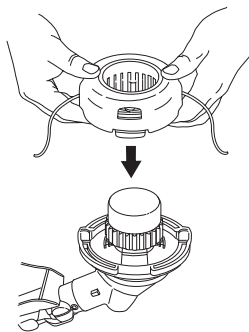

8

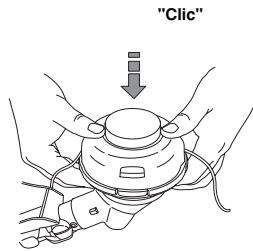

9

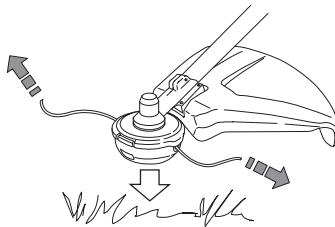

1150989-26



2009-04-10