

**Operator's manual**  
**327LS 327LD<sub>X</sub>-series**

Please read the operator's manual carefully and make sure you understand the instructions before using the machine.



**English**

# KEY TO SYMBOLS

## Symbols

**WARNING!** Clearing saws, brushcutters and trimmers can be dangerous! Careless or incorrect use can result in serious or fatal injury to the operator or others. It is extremely important that you read and understand the contents of the operator's manual.



Please read the operator's manual carefully and make sure you understand the instructions before using the machine.



Always wear:

- A protective helmet where there is a risk of falling objects
- Approved hearing protection
- Approved eye protection



Max. speed of output shaft, rpm



This product is in accordance with applicable EC directives.



Watch out for thrown objects and ricochets.



The operator of the machine must ensure, while working, that no persons or animals come closer than 15 metres.



Machines fitted with saw blades or grass blades can be thrown violently to the side when the blade comes into contact with a fixed object. This is called blade thrust. The blade is capable of amputating an arm or leg. Always keep people and animals at least 15 metres from the machine.



Arrows which show limits for handle positioning.



Always wear approved protective gloves.



Wear sturdy, non-slip boots.



Only use non-metallic, flexible cutting attachments, i.e. trimmer heads with trimmer cord.



Noise emission to the environment according to the European Community's Directive. The machine's emission is specified in chapter Technical data and on label.



**Other symbols/decals on the machine refer to special certification requirements for certain markets.**

The engine is switched off by moving the stop switch to the stop position. **CAUTION!** The stop switch automatically returns to the start position. In order to prevent unintentional starting, the spark plug cap must be removed from the spark plug when assembling, checking and/or performing maintenance.

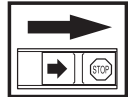

Always wear approved protective gloves.



Regular cleaning is required.

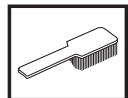

Visual check.



Approved eye protection must always be used.



# CONTENTS

## Contents

### KEY TO SYMBOLS

Symbols ..... 2

### CONTENTS

Contents ..... 3

Note the following before starting: ..... 3

### INTRODUCTION

Dear Customer, ..... 4

### WHAT IS WHAT?

What is what? ..... 5

### GENERAL SAFETY PRECAUTIONS

Important ..... 6

Personal protective equipment ..... 6

Machine's safety equipment ..... 7

Cutting equipment ..... 9

### ASSEMBLY

Fitting the loop handle ..... 10

Assembling and dismantling the two-piece shaft  
(327LDx) ..... 10

Assembling the cutting equipment ..... 11

Fitting the trimmer guard and trimmer head ..... 11

### FUEL HANDLING

Fuel safety ..... 12

Fuel ..... 12

Fuelling ..... 13

### STARTING AND STOPPING

Check before starting ..... 14

Starting and stopping ..... 14

### WORKING TECHNIQUES

General working instructions ..... 16

### MAINTENANCE

Carburettor ..... 18

Muffler ..... 18

Cooling system ..... 19

Spark plug ..... 19

Two-piece shaft (327LDx) ..... 20

Air filter ..... 20

Maintenance schedule ..... 22

### TECHNICAL DATA

Technical data ..... 23

EC-declaration of conformity ..... 24

## Note the following before starting:

Please read the operator's manual carefully.



**WARNING!** Long-term exposure to noise can result in permanent hearing impairment. So always use approved hearing protection.



**WARNING!** Under no circumstances may the design of the machine be modified without the permission of the manufacturer. Always use genuine accessories. Non-authorized modifications and/or accessories can result in serious personal injury or the death of the operator or others.



**WARNING!** A clearing saw, brushcutter or trimmer can be dangerous if used incorrectly or carelessly, and can cause serious or fatal injury to the operator or others. It is extremely important that you read and understand the contents of this operator's manual.

---

# INTRODUCTION

---

## Dear Customer,

Congratulations on your choice to buy a Husqvarna product! Husqvarna is based on a tradition that dates back to 1689, when the Swedish King Karl XI ordered the construction of a factory on the banks of the Husqvarna River, for production of muskets. The location was logical, since water power was harnessed from the Huskvarna River to create the water-powered plant. During the more than 300 years of being, the Husqvarna factory has produced a lot of different products, from wood stoves to modern kitchen appliances, sewing machines, bicycles, motorcycles etc. In 1956, the first motor driven lawn mowers appeared, followed by chain saws in 1959, and it is within this area Husqvarna is working today.

Today Husqvarna is one of the leading manufacturers in the world of forest and garden products, with quality as our highest priority. The business concept is to develop, manufacture and market motor driven products for forestry and gardening as well as for building and construction industry. Husqvarna's aim is also to be in the front edge according to ergonomics, usability, security and environmental protection. That is the reason why we have developed many different features to provide our products within these areas.

We are convinced that you will appreciate with great satisfaction the quality and performance of our product for a very long time to come. The purchase of one of our products gives you access to professional help with repairs and service whenever this may be necessary. If the retailer who sells your machine is not one of our authorised dealers, ask for the address of your nearest service workshop.

It is our wish that you will be satisfied with your product and that it will be your companion for a long time. Think of this operator's manual as a valuable document. By following its' content (using, service, maintenance etc) the life span and the second-hand value of the machine can be extended. If you will sell this machine, make sure that the buyer will get the operator's manual.

Thank you for using a Husqvarna product.

Husqvarna AB has a policy of continuous product development and therefore reserves the right to modify the design and appearance of products without prior notice.

# WHAT IS WHAT?

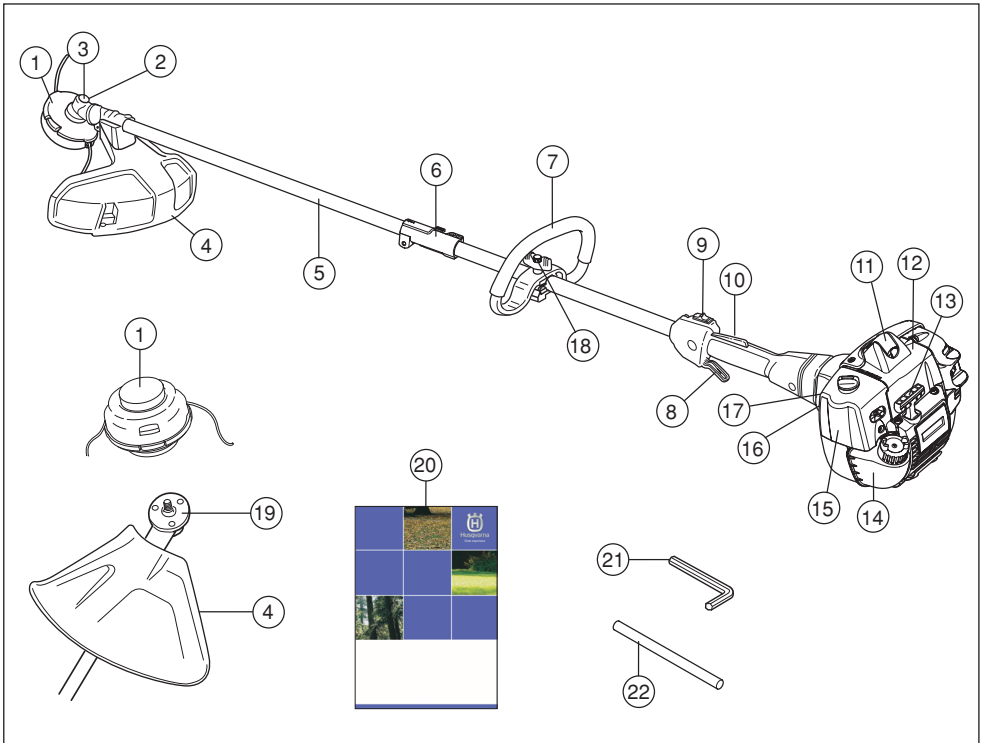

## What is what?

- |    |                               |    |                   |
|----|-------------------------------|----|-------------------|
| 1  | Trimmer head                  | 12 | Cylinder cover    |
| 2  | Grease filler cap, bevel gear | 13 | Starter handle    |
| 3  | Bevel gear                    | 14 | Fuel tank         |
| 4  | Cutting attachment guard      | 15 | Air filter cover  |
| 5  | Shaft                         | 16 | Air purge         |
| 6  | Shaft coupling (327LDx)       | 17 | Choke control     |
| 7  | Loop handle                   | 18 | Handle adjustment |
| 8  | Throttle control              | 19 | Drive disc        |
| 9  | Stop switch                   | 20 | Operator's manual |
| 10 | Throttle lockout              | 21 | Allen key         |
| 11 | Spark plug cap and spark plug | 22 | Locking pin       |

# GENERAL SAFETY PRECAUTIONS

## Important

### IMPORTANT!

The machine is only designed for trimming grass.

The only accessories you can operate with this engine unit are the cutting attachments we recommend in the chapter on Technical data.

Never use the machine if you are tired, if you have drunk alcohol, or if you are taking medication that could affect your vision, your judgement or your co-ordination.

Wear personal protective equipment. See instructions under the heading "Personal protective equipment".

Never use a machine that has been modified in any way from its original specification.

Never use a machine that is faulty. Carry out the checks, maintenance and service instructions described in this manual. Some maintenance and service measures must be carried out by trained and qualified specialists. See instructions under the heading Maintenance.

All covers, guards and handles must be fitted before starting. Ensure that the spark plug cap and ignition lead are undamaged to avoid the risk of electric shock.

The machine operator must ensure that no people or animals come closer than 15 metres while working.

When several operators are working in the same area the safety distance should be at least twice the tree height and no less than 15 metres.



**WARNING!** This machine produces an electromagnetic field during operation. This field may under some circumstances interfere with active or passive medical implants. To reduce the risk of serious or fatal injury, we recommend persons with medical implants to consult their physician and the medical implant manufacturer before operating this machine.



**WARNING!** Running an engine in a confined or badly ventilated area can result in death due to asphyxiation or carbon monoxide poisoning.



**WARNING!** Never allow children to use or be in the vicinity of the machine. As the machine is equipped with a spring-loaded stop switch and can be started by low speed and force on the starter handle, even small children under some circumstances can produce the force necessary to start the machine. This can mean a risk of serious personal injury. Therefore remove the spark plug cap when the machine is not under close supervision.

## Personal protective equipment

### IMPORTANT!

A clearing saw, brushcutter or trimmer can be dangerous if used incorrectly or carelessly, and can cause serious or fatal injury to the operator or others. It is extremely important that you read and understand the contents of this operator's manual.

You must use approved personal protective equipment whenever you use the machine. Personal protective equipment cannot eliminate the risk of injury but it will reduce the degree of injury if an accident does happen. Ask your dealer for help in choosing the right equipment.



**WARNING!** Listen out for warning signals or shouts when you are wearing hearing protection. Always remove your hearing protection as soon as the engine stops.

### HELMET

A protective helmet where there is a risk of falling objects



### HEARING PROTECTION

Wear hearing protection that provides adequate noise reduction.



### EYE PROTECTION

Always wear approved eye protection. If you use a visor then you must also wear approved protective goggles. Approved protective goggles must comply with standard ANSI Z87.1 in the USA or EN 166 in EU countries.



### GLOVES

Gloves should be worn when necessary, e.g., when fitting cutting attachments.



# GENERAL SAFETY PRECAUTIONS

## BOOTS

Wear sturdy, non-slip boots.



## CLOTHING

Wear clothes made of a strong fabric and avoid loose clothing that can catch on twigs and branches. Always wear heavy, long pants. Do not wear jewellery, shorts sandals or go barefoot. Secure hair so it is above shoulder level.

## FIRST AID KIT

Always have a first aid kit nearby.



## Machine's safety equipment

This section describes the machine's safety equipment, its purpose, and how checks and maintenance should be carried out to ensure that it operates correctly. See the "What is what?" section to locate where this equipment is positioned on your machine.

The life span of the machine can be reduced and the risk of accidents can increase if machine maintenance is not carried out correctly and if service and/or repairs are not carried out professionally. If you need further information please contact your nearest service workshop.

### IMPORTANT!

All servicing and repair work on the machine requires special training. This is especially true of the machine's safety equipment. If your machine fails any of the checks described below you must contact your service agent. When you buy any of our products we guarantee the availability of professional repairs and service. If the retailer who sells your machine is not a servicing dealer, ask him for the address of your nearest service agent.



**WARNING! Never use a machine with faulty safety equipment. The machine's safety equipment must be checked and maintained as described in this section. If your machine fails any of these checks contact your service agent to get it repaired.**

## Throttle lockout

The throttle lockout is designed to prevent accidental operation of the throttle control. When you press the lock (A) (i.e. when you grasp the handle) it releases the throttle control (B). When you release the handle the throttle

control and the throttle lockout both move back to their original positions. This movement is controlled by two independent return springs. This arrangement means that the throttle control is automatically locked at the idle setting.

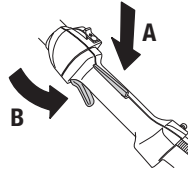

Make sure the throttle control is locked at the idle setting when the throttle lockout is released.

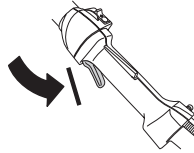

Press the throttle lockout and make sure it returns to its original position when you release it.

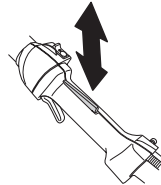

Check that the throttle control and throttle lockout move freely and that the return springs work properly.

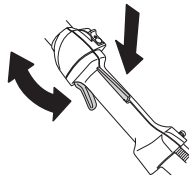

See instructions under the heading Start. Start the machine and apply full throttle. Release the throttle and check that the cutting attachment stops and remains at a standstill. If the cutting attachment rotates with the throttle in the idle position then the carburettor idle setting must be checked. See instructions under the heading Maintenance.

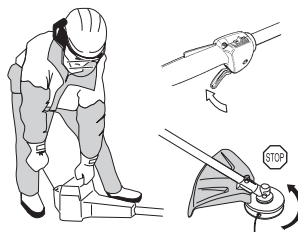

# GENERAL SAFETY PRECAUTIONS

## Stop switch

Use the stop switch to switch off the engine.

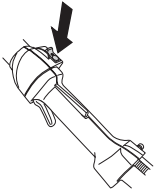

Start the engine and make sure the engine stops when you move the stop switch to the stop setting.

## Cutting attachment guard



This guard is intended to prevent loose objects from being thrown towards the operator. The guard also protects the operator from accidental contact with the cutting attachment.

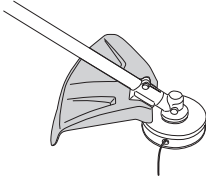

Check that the guard is undamaged and not cracked. Replace the guard if it has been exposed to impact or is cracked.

Always use the recommended guard for the cutting attachment you are using. See chapter on Technical data.



**WARNING! Never use a cutting attachment without an approved guard. See the chapter on Technical data. If an incorrect or faulty guard is fitted this can cause serious personal injury.**

## Vibration damping system



Your machine is equipped with a vibration damping system that is designed to minimize vibration and make operation easier.

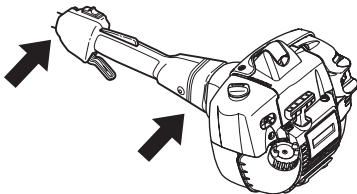

Use of incorrectly wound cord or an incorrect cutting attachment increases the level of vibration. See instructions under the heading Cutting equipment.

The machine's vibration damping system reduces the transfer of vibration between the engine unit/cutting equipment and the machine's handle unit.



Regularly check the vibration damping units for cracks or deformation. Check that the vibration damping element is undamaged and securely attached.



**WARNING! Overexposure to vibration can lead to circulatory damage or nerve damage in people who have impaired circulation. Contact your doctor if you experience symptoms of overexposure to vibration. These symptoms include numbness, loss of feeling, tingling, pricking, pain, loss of strength, changes in skin colour or condition. These symptoms normally appear in the fingers, hands or wrists.**

## Muffler



The muffler is designed to keep noise levels to a minimum and to direct exhaust fumes away from the user. A muffler fitted with a catalytic converter is also designed to reduce harmful exhaust gases.



In countries that have a warm and dry climate there is a significant risk of fire. We therefore fit certain mufflers with a spark arrestor mesh. Check whether the muffler on your machine is fitted with this kind of mesh.

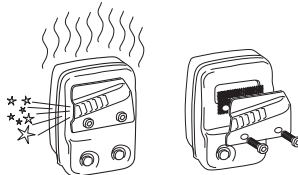

For mufflers it is very important that you follow the instructions on checking, maintaining and servicing your machine.



# GENERAL SAFETY PRECAUTIONS

Never use a machine that has a faulty muffler.



Regularly check that the muffler is securely attached to the machine.



If the muffler on your machine is fitted with a spark arrestor mesh this must be cleaned regularly. A blocked mesh will cause the engine to overheat and may lead to serious damage.

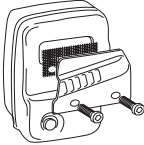

**WARNING!** Mufflers fitted with catalytic converters get very hot during use and remain so for some time after stopping. This also applies at idle speed. Contact can result in burns to the skin. Remember the risk of fire!



**WARNING!** The inside of the muffler contain chemicals that may be carcinogenic. Avoid contact with these elements in the event of a damaged muffler.



**WARNING!** Bear in mind that: The exhaust fumes from the engine are hot and may contain sparks which can start a fire. Never start the machine indoors or near combustible material!

## Cutting equipment

This section describes how to choose and maintain your cutting equipment in order to:

- Reduce the risk of blade thrust.
- Obtain maximum cutting performance.

- Extend the life of cutting equipment.

### IMPORTANT!

Only use cutting attachments with the guards we recommend! See the chapter on Technical data.

Refer to the instructions for the cutting attachment to check the correct way to load the cord and the correct cord diameter.



**WARNING!** Always stop the engine before doing any work on the cutting attachment. This continues to rotate even after the throttle has been released. Ensure that the cutting attachment has stopped completely and disconnect the HT lead from the spark plug before you start to work on it.



**WARNING!** A faulty cutting attachment may increase the risk of accidents.

## Trimmer head

### IMPORTANT!

Always ensure the trimmer cord is wound tightly and evenly around the drum, otherwise the machine will generate harmful vibration.

- Only use the recommended trimmer heads and trimmer cords. These have been tested by the manufacturer to suit a particular engine size. This is especially important when a fully automatic trimmer head is used. Only use the recommended cutting attachment. See the chapter on Technical data.



- Smaller machines generally require small trimmer heads and vice versa. This is because when clearing using a cord the engine must throw out the cord radially from the trimmer head and overcome the resistance of the grass being cleared.
- The length of the cord is also important. A longer cord requires greater engine power than a shorter cord of the same diameter.
- Make sure that the cutter on the trimmer guard is intact. This is used to cut the cord to the correct length.
- To increase the life of the cord it can be soaked in water for a couple of days. This will make the line tougher so that it lasts longer.

# ASSEMBLY

## Fitting the loop handle



- Clip the loop handle onto the shaft. Note that the loop handle must be fitted between the arrows on the shaft.

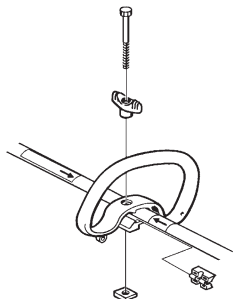

- Slide the spacer into the slot in the loop handle. Fit the nut, knob and screw. Do not overtighten.
- Now adjust the trimmer to give a comfortable working position. Tighten the bolt/knob.

## Assembling and dismantling the two-piece shaft (327LDx)



### Assembly:

- Loosen the coupling by turning the knob.
- Align the tab of the attachment (A) with the arrow on the coupling (B).

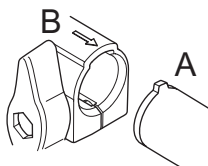

- Push the attachment into the coupling until the attachment snaps into place.

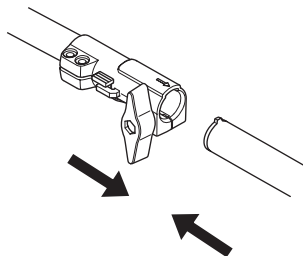

- Before using the unit, tighten the knob securely.

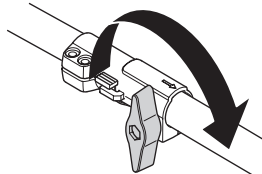

### Dismantling:

- Loosen the coupling by turning the knob (at least 3 times).

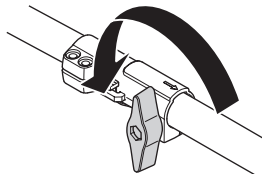

- Push and hold the button (C). While securely holding the engine end, pull the attachment straight out of the coupling.

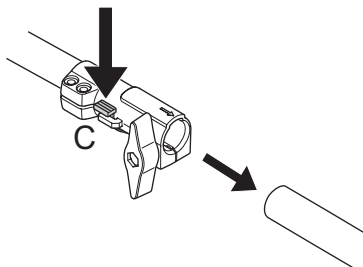

# ASSEMBLY

## Assembling the cutting equipment



### WARNING!

When fitting the cutting attachment it is extremely important that the raised section on the drive disc/support flange engages correctly in the centre hole of the cutting attachment. If the cutting attachment is fitted incorrectly it can result in serious and/or fatal personal injury.



**WARNING!** Never use a cutting attachment without an approved guard. See the chapter on Technical data. If an incorrect or faulty guard is fitted this can cause serious personal injury.

## Fitting the trimmer guard and trimmer head



- Fit the correct trimmer guard (A) for use with the trimmer head. Hook the trimmer guard/combination guard onto the fitting on the shaft and secure with the bolt (L).

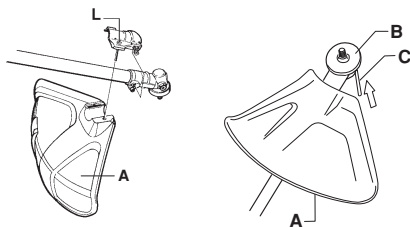

- Fit the drive disc (B) on the output shaft.
- Turn the blade shaft until one of the holes in the drive disc aligns with the corresponding hole in the gear housing.
- Insert the locking pin (C) in the hole to lock the shaft.

- Screw on the trimmer head/plastic blades (H) in the opposite direction to the direction of rotation.

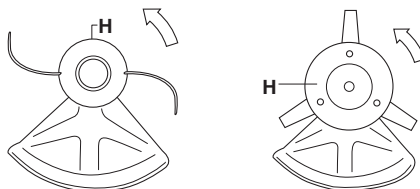

- To dismantle, follow the instructions in the reverse order.

# FUEL HANDLING

## Fuel safety

Never start the machine:

- 1 If you have spilt fuel on it. Wipe off the spillage and allow remaining fuel to evaporate.
- 2 If you have spilt fuel on yourself or your clothes, change your clothes. Wash any part of your body that has come in contact with fuel. Use soap and water.
- 3 If the machine is leaking fuel. Check regularly for leaks from the fuel cap and fuel lines.

## Transport and storage

- Store and transport the machine and fuel so that there is no risk of any leakage or fumes coming into contact with sparks or naked flames, for example, from electrical machinery, electric motors, electrical relays/switches or boilers.
- When storing and transporting fuel always use approved containers intended for this purpose.
- When storing the machine for long periods the fuel tank must be emptied. Contact your local petrol station to find out where to dispose of excess fuel.
- Ensure the machine is cleaned and that a complete service is carried out before long-term storage.
- The transport guard must always be fitted to the cutting attachment when the machine is being transported or in storage.
- Secure the machine during transport.
- In order to prevent unintentional starting of the engine, the spark plug cap must always be removed during long-term storage, if the machine is not under close supervision and when performing all service measures.



**WARNING! Take care when handling fuel. Bear in mind the risk of fire, explosion and inhaling fumes.**

## Fuel

**CAUTION!** The machine is equipped with a two-stroke engine and must always be run using a mixture of petrol and two-stroke oil. It is important to accurately measure the amount of oil to be mixed to ensure that the correct mixture is obtained. When mixing small amounts of fuel, even small inaccuracies can drastically affect the ratio of the mixture.



**WARNING! Fuel and fuel fumes are highly inflammable and can cause serious injury when inhaled or allowed to come in contact with the skin. For this reason observe caution when handling fuel and make sure there is adequate ventilation.**

## Petrol



**CAUTION!** Always use a quality petrol/oil mixture at least 90 octane (RON). If your machine is equipped with a catalytic converter (see chapter on Technical data) always use a good quality unleaded petrol/oil mixture. Leaded petrol will destroy the catalytic converter.

Use low-emission petrol, also known as alkylate petrol, if it is available.



- The lowest octane recommended is 90 (RON). If you run the engine on a lower octane grade than 90 so-called knocking can occur. This gives rise to a high engine temperature, which can result in serious engine damage.
- When working at continuous high revs a higher octane rating is recommended.

## Two-stroke oil

- For best results and performance use HUSQVARNA two-stroke engine oil, which is specially formulated for our air-cooled two-stroke engines.
- Never use two-stroke oil intended for water-cooled engines, sometimes referred to as outboard oil (rated TCW).
- Never use oil intended for four-stroke engines.
- A poor oil quality and/or too high oil/fuel ratio may jeopardise function and decrease the life time of catalytic converters.
- Mixing ratio
  - 1:50 (2%) with HUSQVARNA two-stroke oil.
  - 1:33 (3%) with oils class JASO FB or ISO EGB formulated for air-cooled, two-stroke engines.

Petrol, litre	Two-stroke oil, litre	
	2% (1:50)	3% (1:33)
5	0,10	0,15
10	0,20	0,30
15	0,30	0,45
20	0,40	0,60

# FUEL HANDLING

## Mixing

- Always mix the petrol and oil in a clean container intended for fuel.
- Always start by filling half the amount of the petrol to be used. Then add the entire amount of oil. Mix (shake) the fuel mixture. Add the remaining amount of petrol.
- Mix (shake) the fuel mixture thoroughly before filling the machine's fuel tank.



- Do not mix more than one month's supply of fuel at a time.
- If the machine is not used for some time the fuel tank should be emptied and cleaned.



**WARNING!** The catalytic converter muffler gets very hot during and after use. This also applies during idling. Be aware of the fire hazard, especially when working near flammable substances and/or vapours.

## Fuelling



**WARNING!** Taking the following precautions, will lessen the risk of fire:

**Do not smoke or place hot objects near fuel.**

**Always shut off the engine before refuelling.**

**Always stop the engine and let it cool for a few minutes before refuelling.**

**When refuelling, open the fuel cap slowly so that any excess pressure is released gently.**

**Tighten the fuel cap carefully after refuelling.**

**Always move the machine away from the refuelling area before starting.**

- Always use a fuel container with an anti-spill valve.
- Clean the area around the fuel cap. Contamination in the tank can cause operating problems.
- Ensure that the fuel is well mixed by shaking the container before filling the tank.

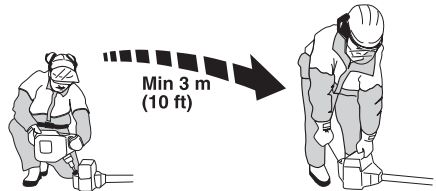

Min 3 m  
(10 ft)

# STARTING AND STOPPING

## Check before starting



- Check that the support flange is not cracked due to fatigue or due to being tightened too much. Discard the support flange if it is cracked.

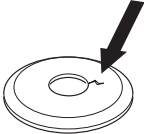

- Ensure the locking nut has not lost its captive force. The nut lock should have a locking force of at least 1.5 Nm. The tightening torque of the locking nut should be 35-50 Nm.



- Check that the trimmer head and trimmer guard are not damaged or cracked. Replace the trimmer head or trimmer guard if they have been exposed to impact or are cracked.

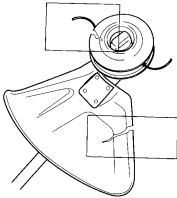

- Never use the machine without a guard nor with a defective guard.
- All covers must be correctly fitted and undamaged before you start the machine.

## Starting and stopping



**WARNING!** The complete clutch cover and shaft must be fitted before the machine is started, otherwise the clutch can come loose and cause personal injury.

Always move the machine away from the refuelling area before starting. Place the machine on a flat surface. Ensure the cutting attachment cannot come into contact with any object.

Make sure no unauthorised persons are in the working area, otherwise there is a risk of serious personal injury. The safety distance is 15 metres.

### Starting

**Primer bulb:** Press the air purge repeatedly until fuel begins to fill the bulb. The bulb need not be completely filled.

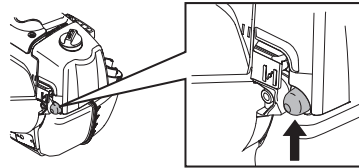

**Choke:** Set the choke control in the choke position.

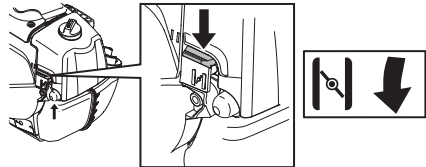

**WARNING!** When the engine is started with the choke in either the choke or start throttle positions the cutting attachment will start to rotate immediately.

Hold the body of the machine on the ground using your left hand (CAUTION! Not with your foot!). Grip the starter handle, slowly pull out the cord with your right hand until you feel some resistance (the starter pawls grip), now quickly and powerfully pull the cord. **Never twist the starter cord around your hand.**

Repeat pulling the cord until the engine starts. When the engine starts, return choke control to run position and apply full throttle; the throttle will automatically disengage from the start setting.

---

## STARTING AND STOPPING

---

**CAUTION!** Do not pull the starter cord all the way out and do not let go of the starter handle when the cord is fully extended. This can damage the machine.



**CAUTION!** Do not put any part of your body in marked area. Contact can result in burns to the skin, or electrical shock if the spark plug cap has been damaged. Always use gloves. Do not use a machine with damaged spark plug cap.

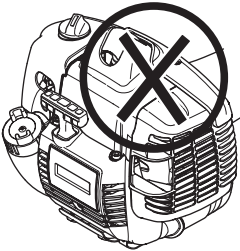

### Stopping

Stop the engine by switching off the ignition.

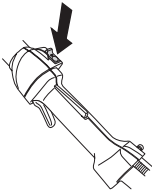

**CAUTION!** The stop switch automatically returns to the start position. In order to prevent unintentional starting, the spark plug cap must be removed from the spark plug when assembling, checking and/or performing maintenance.

# WORKING TECHNIQUES

## General working instructions

### IMPORTANT!

This section takes up the basic safety precautions for working with a trimmer.

If you encounter a situation where you are uncertain how to proceed you should ask an expert. Contact your dealer or your service workshop.

Avoid all usage which you consider to be beyond your capability.

You must understand the difference between forestry clearing, grass clearing and grass trimming before use.

## Basic safety rules



- 1 Look around you:
  - To ensure that people, animals or other things cannot affect your control of the machine.
  - To ensure that people, animals, etc., do not come into contact with the cutting attachment or loose objects that are thrown out by the cutting attachment.
- 2 CAUTION! Do not use the machine unless you are able to call for help in the event of an accident.
- 2 Inspect the working area. Remove all loose objects, such as stones, broken glass, nails, steel wire, string, etc. that could be thrown out or become wrapped around the cutting attachment.
- 3 Do not use the machine in bad weather, such as dense fog, heavy rain, strong wind, intense cold, etc. Working in bad weather is tiring and often brings added risks, such as icy ground, unpredictable felling direction, etc.
- 4 Make sure you can move and stand safely. Check the area around you for possible obstacles (roots, rocks, branches, ditches, etc.) in case you have to move suddenly. Take great care when working on sloping ground.



- 5 Keep a good balance and a firm foothold.

- 6 Always hold the machine with both hands. Hold the machine on the right side of your body.



- 7 Keep the cutting attachment below waist level.
- 8 The engine must be switched off before moving.
- 9 Never put the machine down with the engine running unless you have it in clear sight.



**WARNING! Neither the operator of the machine nor anyone else may attempt to remove the cut material while the engine is running or the cutting equipment is rotating, as this can result in serious injury.**

**Stop the engine and cutting equipment before you remove material that has wound around the blade shaft as otherwise there is a risk of injury. The bevel gear can get hot during use and may remain so for a while afterwards. You could get burnt if you touch it.**



**WARNING! Watch out for thrown objects. Always wear approved eye protection. Never lean over the cutting attachment guard. Stones, rubbish, etc. can be thrown up into the eyes causing blindness or serious injury.**

**Keep unauthorised persons at a distance. Children, animals, onlookers and helpers should be kept outside the safety zone of 15 m. Stop the machine immediately if anyone approaches. Never swing the machine around without first checking behind you to make sure no one is within the safety zone.**



# WORKING TECHNIQUES

## Basic working techniques

Always slow the engine to idle speed after each working operation. Long periods at full throttle without any load on the engine can lead to serious engine damage.



**WARNING! Sometimes branches or grass get caught between the guard and cutting attachment. Always stop the engine before cleaning.**

## Grass trimming with a trimmer head



### Trimming

- Hold the trimmer head just above the ground at an angle. It is the end of the cord that does the work. Let the cord work at its own pace. Never press the cord into the area to be cut.

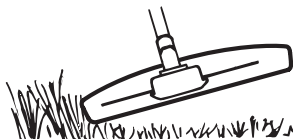

- The cord can easily remove grass and weeds up against walls, fences, trees and borders, however it can also damage sensitive bark on trees and bushes, and damage fence posts.
- Reduce the risk of damaging plants by shortening the cord to 10-12 cm and reducing the engine speed.

### Clearing

- The clearing technique removes all unwanted vegetation. Keep the trimmer head just above the ground and tilt it. Let the end of the cord strike the ground around trees, posts, statues and the like. **CAUTION!** This technique increases the wear on the cord.

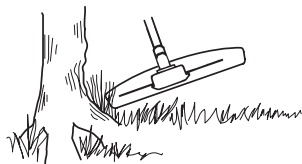

- The cord wears quicker and must be fed forward more often when working against stones, brick, concrete, metal fences, etc., than when coming into contact with trees and wooden fences.
- When trimming and clearing you should use less than full throttle so that the cord lasts longer and to reduce the wear on the trimmer head.

## Cutting

- The trimmer is ideal for cutting grass that is difficult to reach using a normal lawn mower. Keep the cord parallel to the ground when cutting. Avoid pressing the trimmer head against the ground as this can ruin the lawn and damage the tool.

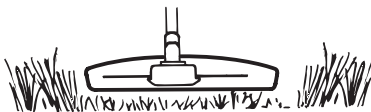

- Do not allow the trimmer head to constantly come into contact with the ground during normal cutting. Constant contact of this type can cause damage and wear to the trimmer head.

## Sweeping

- The fan effect of the rotating cord can be used for quick and easy clearing up. Hold the cord parallel to and above the area to be swept and move the tool to and fro.

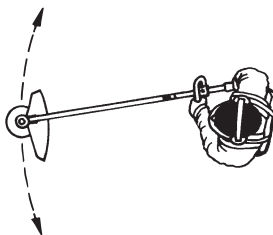

- When cutting and sweeping you should use full throttle to obtain the best results.

# MAINTENANCE

## Carburettor

Your Husqvarna product has been designed and manufactured to specifications that reduce harmful emissions. After the engine has used 8-10 tanks of fuel the engine will be run-in. To ensure that it continues to run at peak performance and to minimise harmful exhaust emissions after the running-in period, ask your dealer/service workshop (who will have a rev counter at their disposal) to adjust your carburettor.

### Function



- The carburettor governs the engine's speed via the throttle control. Air and fuel are mixed in the carburettor. The air/fuel mixture is adjustable. Correct adjustment is essential to get the best performance from the machine.
- Adjusting the carburettor means that the engine is adapted to local operating conditions, e.g. climate, altitude, petrol and the type of 2-stroke oil.
- The carburettor has three adjustment controls:
  - L = Low speed jet
  - H = High speed jet
  - T = Idle adjustment screw

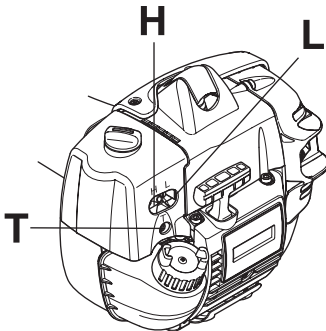

- The L and H-jets are used to adjust the supply of fuel to match the rate that air is admitted, which is controlled with the throttle. If they are screwed clockwise the air/fuel ratio becomes leaner (less fuel) and if they are turned anti-clockwise the ratio becomes richer (more fuel). A lean mixture gives a higher engine speed and a rich mixture gives a lower engine speed.
- The T-screw regulates the throttle setting at idle speed. If the T-screw is turned clockwise this gives a higher idle speed; turning it anti-clockwise gives a lower idle speed.

## Basic setting

- The basic carburettor settings are adjusted during testing at the factory. The basic setting is richer than the optimal setting and should be maintained for the first few hours the machine is in use. The carburettor should then be finely adjusted. Fine adjustment should be carried out by a skilled technician.

**CAUTION!** If the cutting attachment rotates when the engine is idling the idle adjustment screw T should be turned anti-clockwise until the cutting attachment stops.

### Adjustment of the idle speed

Before any adjustments are made, make sure that the air filter is clean and the air filter cover is fitted.

Adjust the idle speed using the idle adjustment screw T, if it is necessary to readjust. First turn the idle adjustment screw T clockwise until the cutting attachment starts to rotate. Then turn the screw anticlockwise until the cutting attachment stops. The idle speed is correctly adjusted when the engine will run smoothly in every position. The idle speed should also be well below the speed at which the cutting attachment starts to rotate.

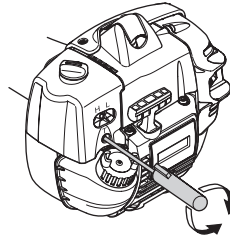

**Rec. idle speed:** See the Technical data section.



**WARNING!** If the idle speed cannot be adjusted so that the cutting attachment stops, contact your dealer/service workshop. Do not use the machine until it has been correctly adjusted or repaired.

## Muffler

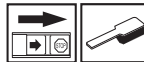

**CAUTION!** Some mufflers are fitted with a catalytic converter. See chapter on Technical data to see whether your machine is fitted with a catalytic converter.

The muffler is designed to reduce the noise level and to direct the exhaust gases away from the operator. The exhaust gases are hot and can contain sparks, which may

# MAINTENANCE

cause fire if directed against dry and combustible material.

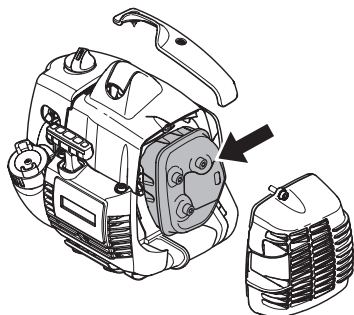

Some mufflers are equipped with a special spark arrestor mesh. If your machine has this type of muffler, you should clean the mesh at least once a week. This is best done with a wire brush. On mufflers without a catalytic converter the mesh should be cleaned weekly, or replaced if necessary. On mufflers fitted with a catalytic converter the mesh should be checked, and if necessary cleaned, monthly. **If the mesh is damaged it should be replaced.** If the mesh is frequently blocked, this can be a sign that the performance of the catalytic converter is impaired. Contact your dealer to inspect the muffler. A blocked mesh will cause the machine to overheat and result in damage to the cylinder and piston.

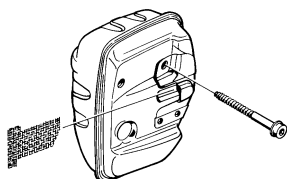

**CAUTION!** Never use a machine with a defective muffler.



**WARNING! Mufflers fitted with catalytic converters get very hot during use and remain so for some time after stopping. This also applies at idle speed. Contact can result in burns to the skin. Remember the risk of fire!**

## Cooling system

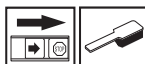

To keep the working temperature as low as possible the machine is equipped with a cooling system.

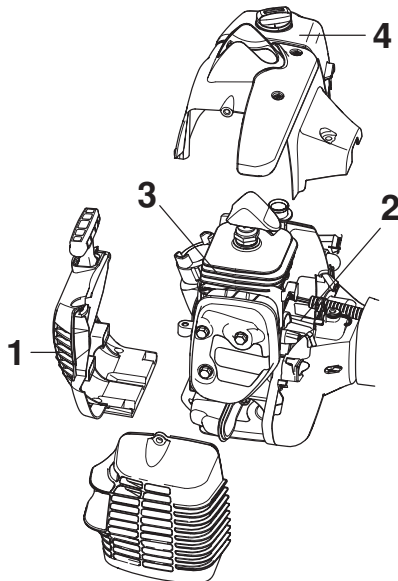

The cooling system consists of:

- 1 Air intake on the starter.
- 2 Fins on the flywheel.
- 3 Cooling fins on the cylinder.
- 4 Cylinder cover (directs cold air over the cylinder).

Clean the cooling system with a brush once a week, more often in demanding conditions. A dirty or blocked cooling system results in the machine overheating which causes damage to the piston and cylinder.

## Spark plug



The spark plug condition is influenced by:

- Incorrect carburettor adjustment.
- An incorrect fuel mixture (too much or incorrect type of oil).
- A dirty air filter.

These factors cause deposits on the spark plug electrodes, which may result in operating problems and starting difficulties.

# MAINTENANCE

If the machine is low on power, difficult to start or runs poorly at idle speed: always check the spark plug first before taking any further action. If the spark plug is dirty, clean it and check that the electrode gap is 0.5 mm. The spark plug should be replaced after about a month in operation or earlier if necessary.

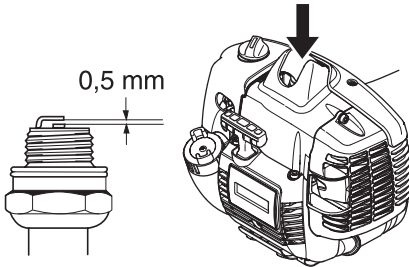

**CAUTION!** Always use the recommended spark plug type! Use of the wrong spark plug can damage the piston/cylinder. Check that the spark plug is fitted with a suppressor.

## Two-piece shaft (327LDx)



The drive shaft end in the lower shaft should be lubricated with grease every 30 hours. There is a risk that the drive shaft ends (splined coupling) on models with two-piece shafts will seize if they are not lubricated regularly.

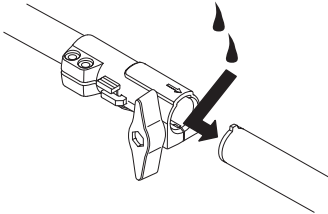

## Air filter



The air filter must be regularly cleaned to remove dust and dirt in order to avoid:

- Carburettor malfunctions
- Starting problems
- Loss of engine power
- Unnecessary wear to engine parts.

- Excessive fuel consumption.

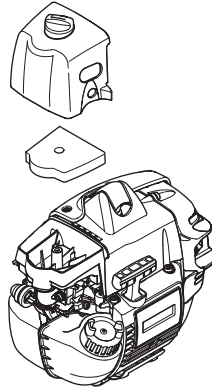

Clean the filter every 25 hours, or more regularly if conditions are exceptionally dusty.

## Cleaning the air filter

Remove the air filter cover and take out the filter. Wash it clean in warm, soapy water. Ensure that the filter is dry before refitting it.

An air filter that has been in use for a long time cannot be cleaned completely. The filter must therefore be replaced with a new one at regular intervals. **A damaged air filter must always be replaced.**

If the machine is used in dusty conditions the air filter should be soaked in oil. See instructions under the heading Oiling the air filter.

## Oiling the air filter

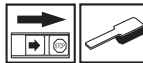

Always use HUSQVARNA filter oil, art. no. 531 00 92-48. The filter oil contains a solvent to make it spread evenly through the filter. You should therefore avoid skin contact.

Put the filter in a plastic bag and pour the filter oil over it. Knead the plastic bag to distribute the oil. Squeeze the excess oil out of the filter inside the plastic bag and pour off the excess before fitting the filter to the machine. Never use common engine oil. This would drain through the filter quite quickly and collect in the bottom.

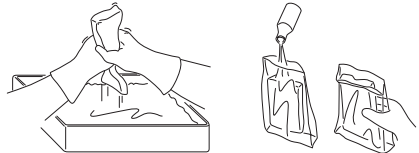

---

## MAINTENANCE

---

### Bevel gear



The bevel gear is filled with the right quantity of grease at the factory. However, before using the machine you should check that the bevel gear is filled three-quarters full with grease. Use HUSQVARNA special grease.

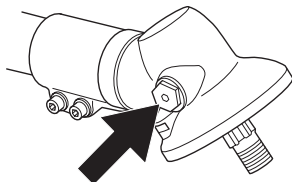

The grease in the bevel gear does not normally need to be changed except if repairs are carried out.

# MAINTENANCE

## Maintenance schedule

The following is a list of the maintenance that must be performed on the machine. Most of the items are described in the Maintenance section. The user must only carry out the maintenance and service work described in this Operator's Manual. More extensive work must be carried out by an authorized service workshop.

Maintenance	Daily maintenance	Weekly maintenance	Monthly maintenance
Clean the outside of the machine.	X		
Make sure the throttle trigger lock and the throttle function correctly from a safety point of view.	X		
Check that the stop switch works correctly.	X		
Check that the cutting attachment does not rotate at idle.	X		
Clean the air filter. Replace if necessary.	X		
Check that the guard is undamaged and not cracked. Replace the guard if it has been exposed to impact or is cracked.	X		
Check that the trimmer head is undamaged and not cracked. Replace the trimmer head if necessary.	X		
Check that nuts and screws are tight.	X		
Check that there are no fuel leaks from the engine, tank or fuel lines.	X		
Check the starter and starter cord.		X	
Check that the vibration damping elements are not damaged.		X	
Clean the outside of the spark plug. Remove it and check the electrode gap. Adjust the gap to 0.5 mm or replace the spark plug. Check that the spark plug is fitted with a suppressor.		X	
Clean the machine's cooling system.		X	
Clean or replace the spark arrestor mesh on the muffler (only applies to mufflers without a catalytic converter).		X	
Clean the outside of the carburettor and the space around it.		X	
Check that the bevel gear is filled three-quarters full with lubricant. Fill if necessary using special grease.		X	
Check the fuel filter from contamination and the fuel hose from cracks or other defects. Replace if necessary.			X
Check all cables and connections.			X
Check the clutch, clutch springs and the clutch drum for wear. Replace if necessary by an authorized service workshop.			X
Replace the spark plug. Check that the spark plug is fitted with a suppressor.			X
Check and clean the spark arrestor mesh on the muffler (only applies to mufflers fitted with a catalytic converter).			X

---

# TECHNICAL DATA

---

## Technical data

	327LDx	327LS
<b>Engine</b>		
Cylinder displacement, cm <sup>3</sup>	24,5	24,5
Cylinder bore, mm	34	34
Stroke, mm	27	27
Idle speed, rpm	2700	2700
Recommended max. speed, rpm	11000-11700	11000-11700
Speed of output shaft, rpm	8300	8300
Max. engine output, acc. to ISO 8893, kW/ rpm	0,9/8400	0,9/8400
Catalytic converter muffler	Yes	Yes
Speed-regulated ignition system	Yes	Yes
<b>Ignition system</b>		
Spark plug	Champion RCJ 6Y	Champion RCJ 6Y
Electrode gap, mm	0,5	0,5
<b>Fuel and lubrication system</b>		
Fuel tank capacity, litre	0,5	0,5
<b>Weight</b>		
Weight without fuel, cutting attachment and guard, kg	5,1	4,8
<b>Noise emissions</b>		
(see note 1)		
Sound power level, measured dB(A)	109	109
Sound power level, guaranteed L <sub>WA</sub> dB(A)	110	110
<b>Noise levels</b>		
(see note 2)		
Equivalent sound pressure level at the operator's ear, measured according to EN ISO 11806 and ISO 22868, dB(A):	94	98
<b>Vibration levels</b>		
(see note 3)		
Equivalent vibration levels (a <sub>h<sub>v</sub>,eq</sub> ) at handles, measured according to EN ISO 11806 and ISO 22867, m/s <sup>2</sup>		
Equipped with trimmer head (original), left/right	2,9/3,4	4,2/3,1

Note 1: Noise emissions in the environment measured as sound power (L<sub>WA</sub>) in conformity with EC directive 2000/14/EC. Reported sound power level for the machine has been measured with the original cutting attachment that gives the highest level. The difference between guaranteed and measured sound power is that the guaranteed sound power also includes dispersion in the measurement result and the variations between different machines of the same model according to Directive 2000/14/EC.

Note 2: Reported data for equivalent sound pressure level for the machine has a typical statistical dispersion (standard deviation) of 1 dB (A).

Note 3: Reported data for equivalent vibration level has a typical statistical dispersion (standard deviation) of 1 m/s<sup>2</sup>.

# TECHNICAL DATA

Approved accessories	Type	Cutting attachment guard, Art. no.
Blade shaft thread M10		
Plastic blades	Tricut Ø 300 mm (Separate blades have part number 531 01 77-15)	503 93 42-02
Trimmer head	T25 (Ø 2.0 - 2.7 mm cord)	503 93 42-02 / 503 97 71-01
	S35 (Ø 2.4 - 3.0 mm cord)	503 93 42-02 / 503 97 71-01
	T35 (Ø 2.4 - 3.0 mm cord)	503 93 42-02 / 503 97 71-01

The following attachments are recommended for the specified models.

Attachments	Art No.	Use with
Hedge trimmer attachment with shaft HA 110	537 19 66-01	327LDx
Hedge trimmer attachment with shaft HA 850	537 19 66-02	327LDx
Clean sweep attachment with shaft SR600	537 19 67-01	327LDx
Edger attachment with shaft	537 19 69-01	327LDx
Saw attachment with shaft PA 1100	537 18 33-17	327LDx
Cultivator attachment with shaft CA 150	537 42 54-01	327LDx

The following attachments have been developed mainly for the Husqvarna 125LD trimmer, but can also be used with the specified models.

Approved accessories	Art No.	Use with
Cultivator attachment CAC	952 71 19-07	327LDx
Edger attachment EAC	952 71 19-08	327LDx
Pole saw attachment PAC	952 71 19-10	327LDx
Blower attachment BAC	952 71 19-11	327LDx
Hedge trimmer attachment HAC	952 71 19-21	327LDx

## EC-declaration of conformity (Applies to Europe only)

We, **Husqvarna AB**, SE-561 82 Huskvarna, Sweden, tel: +46-36-146500, declare that the clearing saws **Husqvarna 327LS and 327LDX** with serial numbers dating from 2009 onwards (the year is clearly stated on the rating plate, followed by the serial number), comply with the requirements of the COUNCIL'S DIRECTIVE:

- of May 17, 2006 "relating to machinery" **2006/42/EC**
- of December 15, 2004 "relating to electromagnetic compatibility" **2004/108/EC**.
- of May 8, 2000 "relating to the noise emissions in the environment" **2000/14/EC**. Conformity assessment according to Annex V. For information relating to noise emissions, see the chapter Technical data.

The following standards have been applied: **EN ISO 12100-2:2003, CISPR 12:2005, EN ISO 11806:1997**

SMP Svensk Maskinprovning AB, Fyrisborgsgatan 3, SE-754 50 Uppsala, Sweden, has performed voluntary type examination on behalf of Husqvarna AB. The certificates are numbered: **SEC/09/2170, 01/164/064 - 327LDx, SEC/09/2170, 01/164/066 - 327LS**

Huskvarna December 29, 2009



Bo Jonsson, Development manager



# Tri Cut

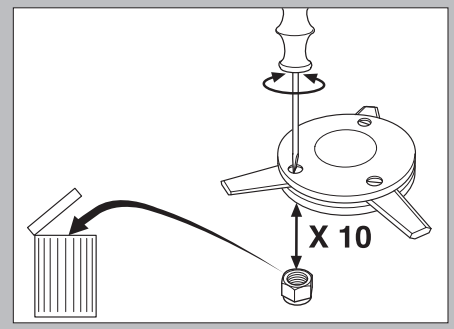
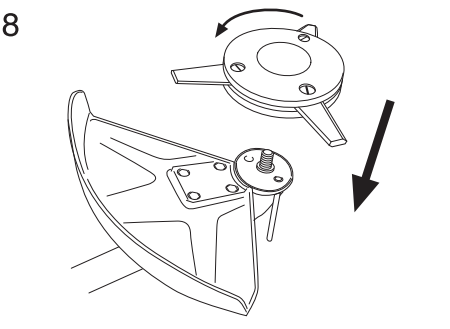
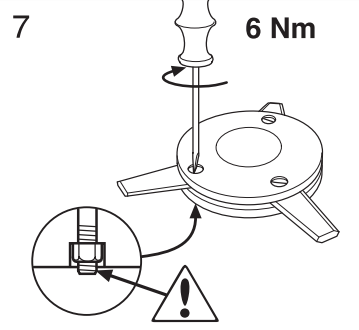
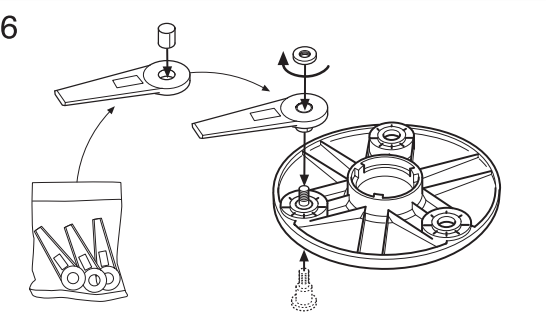
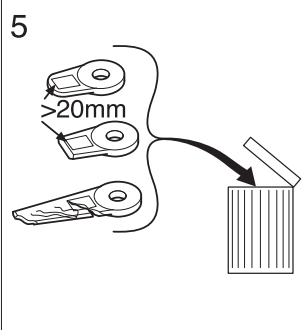
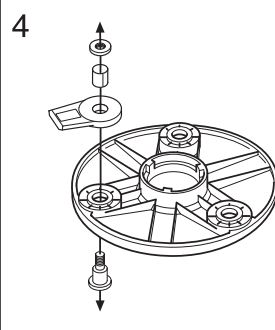
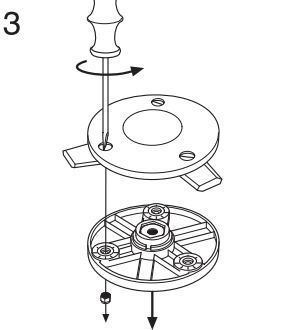
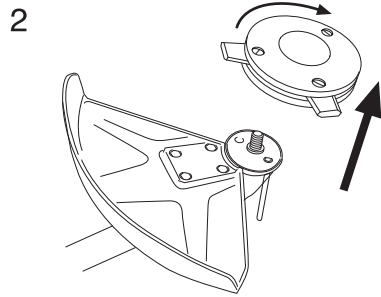
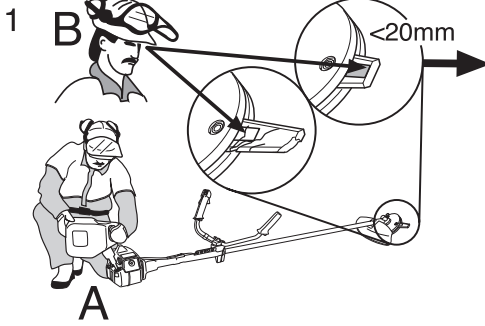

S35



1

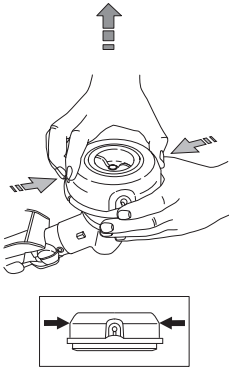

2

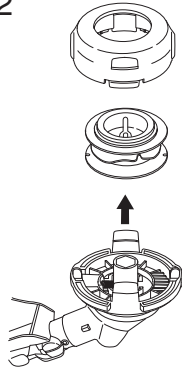

3

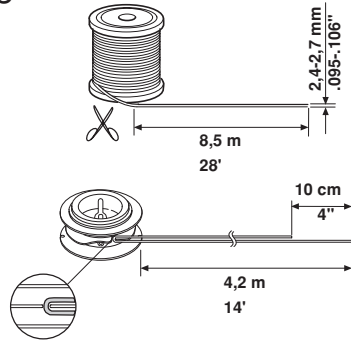

4

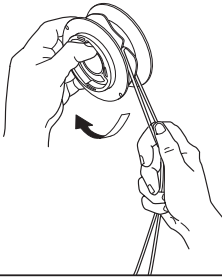

5

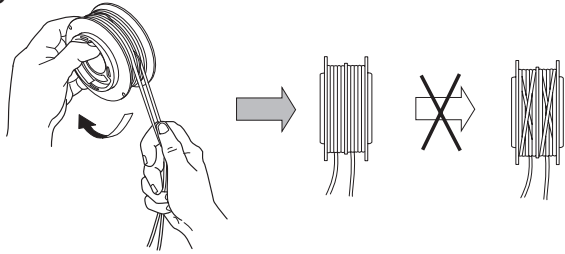

6

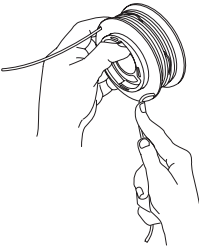

7

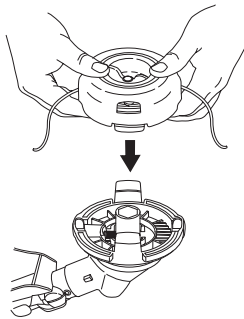

8

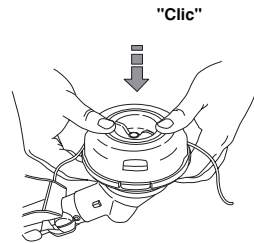

10

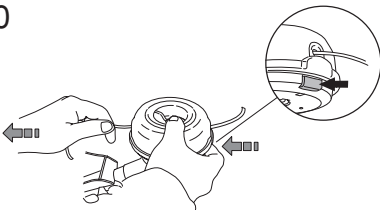

11

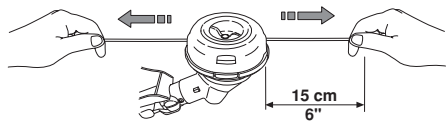

S35



1

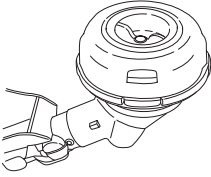

2

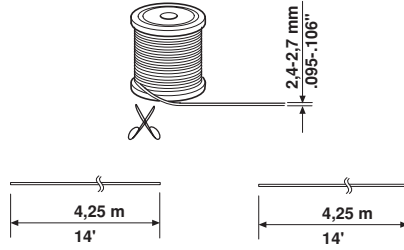

3

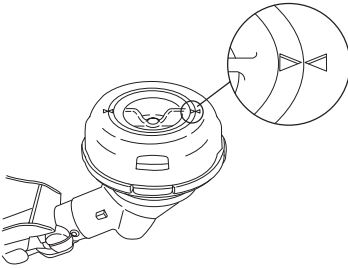

4

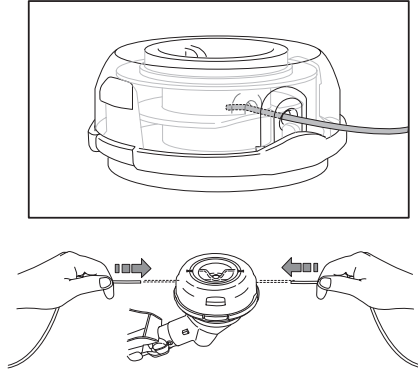

5

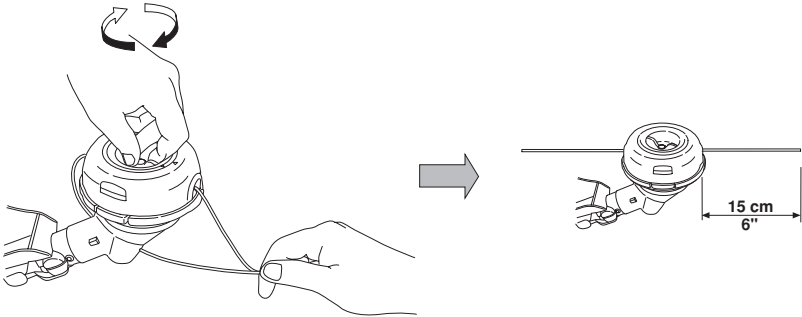

A

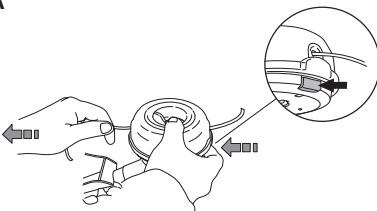

B

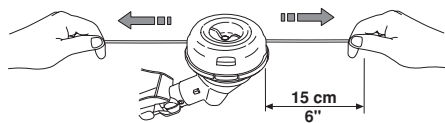

# T35, T35x



1

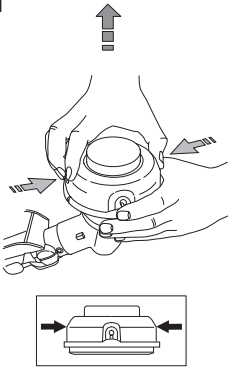

2

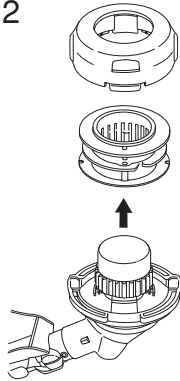

3

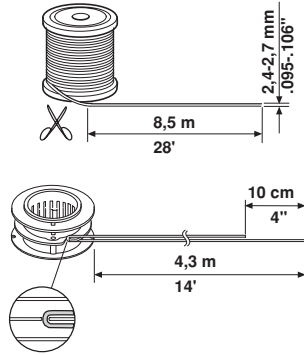

4

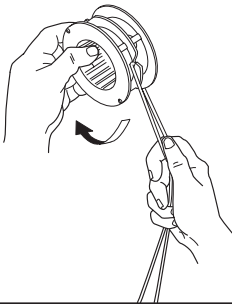

5

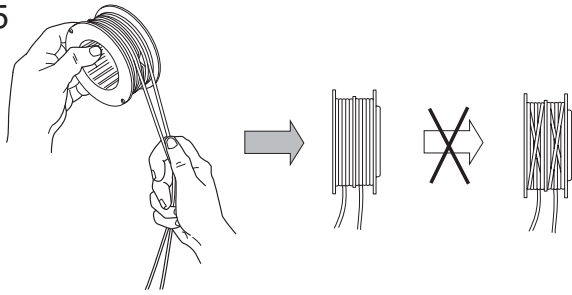

6

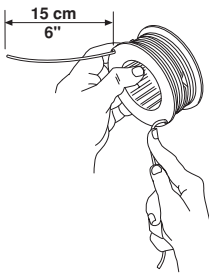

7

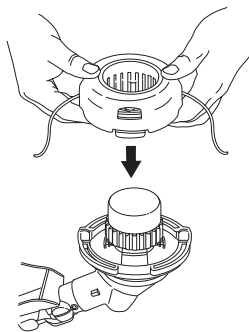

8

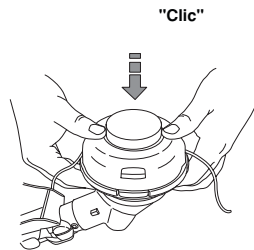

9

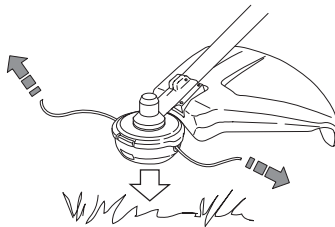

T25



1

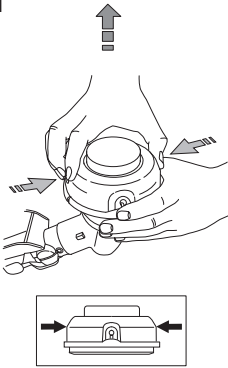

2

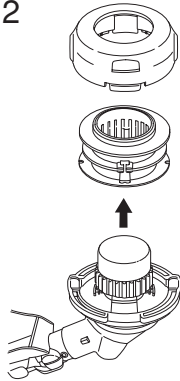

3

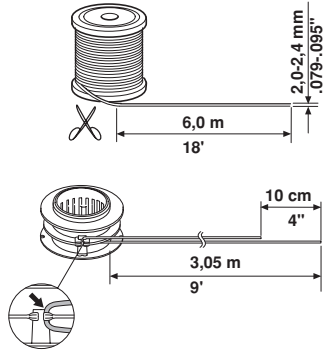

4

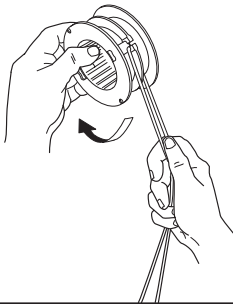

5

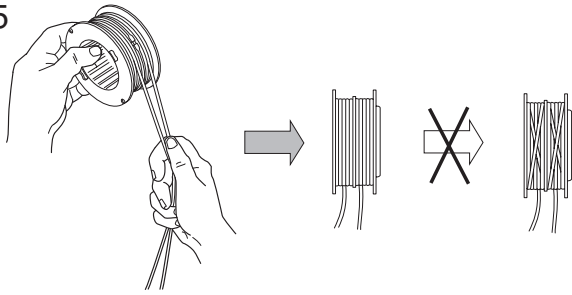

6

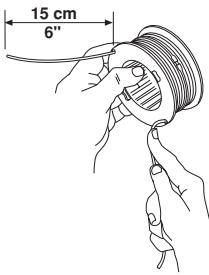

7

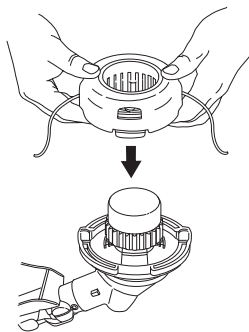

8

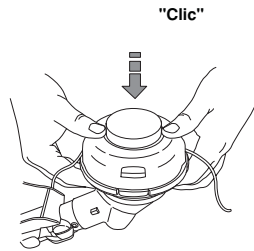

9

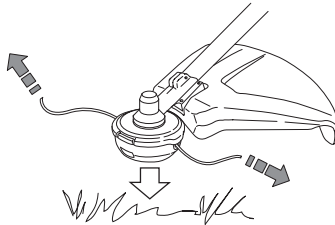















**Original instructions**

**1153293-26**



**2010-03-03**