

Operator's manual
Rider 111B
Rider 111B5

Please read the operator's manual carefully and make sure you understand the instructions before using the machine.



English

CONTENTS

Contents

CONTENTS

Contents	2
INTRODUCTION	
Dear Customer,	3
Driving and transport on public roads	3
Towing	3
Use	3
Good service	3
Service journal	
Pre-delivery service	4
After the first 8 hours	4
KEY TO SYMBOLS	
Symbols	5
SAFETY INSTRUCTIONS	
Safety instructions	6
Driving on slopes	7
Children	8
Maintenance	8
Transport	9
WHAT IS WHAT?	
Location of the controls	10
PRESENTATION	
Presentation	11
Cutting unit	11
Lifting lever for the cutting unit	11
Cutting height adjustment lever	12
Seat	12
Fuelling	12
Release lever	12
Driving	
Before starting	13
Start the engine	13
Starting the engine with a weak battery	14
Driving the Rider	14
Cutting tips	15
Starting on a slope, manual gearbox	15
Stop the engine	15
Maintenance	
Maintenance schedule	16
Cleaning	17
Removing of the machine hoods	17
Checking and adjusting the steering wires	17
Checking the brake	18
Adjusting the throttle wire	18
Replacing the air filter	18
Replacement of fuel filter	19
Checking the fuel pump's air filter	19
Checking the tyre pressure	19
Ignition system	19
Fuses	20
Check the safety system	21
Checking the engine's cooling air intake	22
Service position for the cutting unit	22
Checking the blades	23
Removing the BioClip plug	23

Lubrication

Checking the engine's oil level.	24
Replacing the engine oil	24
Lubricating the front wheel bearings	24
General lubrication	24

Troubleshooting schedule

Storage

Winter storage	26
Guard	26
Service	26

TECHNICAL DATA

EC-declaration of conformity	28
------------------------------------	----

INTRODUCTION

Dear Customer,

Thank you for choosing a Husqvarna Rider. Husqvarna Riders are built to a unique design with a front-mounted cutting unit and a patented rear-wheel steering system. Riders are designed for maximum efficiency even in small or confined areas. The closely grouped controls and pedal-operated hydrostatic transmission also contribute to the performance of this machine.

This operator's manual is a valuable document. By following its instructions (on operation, service, maintenance, etc.) you will significantly extend the life of the machine and even its second-hand value.

When you sell your Rider, make sure you pass on the operator's manual to the new owner.

The last chapter in the operator's manual consists of a Service Journal. Make sure that all service work and repairs are recorded. A well-documented service history reduces the costs of seasonal maintenance and influences the second-hand value of the machine. Bring the operator's manual with the Rider when bringing it to a workshop for service procedures.

Driving and transport on public roads

Check the relevant road traffic regulations before driving the machine on a public road. If transporting the machine on another vehicle always use approved securing devices and make sure that the machine is securely held.

Towing

When your machine is equipped with a hydrostatic transmission you should only tow the machine over short distances and at a low speed, otherwise there is a risk of damaging the transmission.

The power transmission must be disengaged when towing, see the instructions under the heading Clutch control.

Use

This ride-on mower is designed to mow grass on open and level ground surfaces. In addition, there is a number of accessories recommended by the manufacturer that broadens the application area. Please contact your dealer for more information about which accessories are available. The machine may only be used with the equipment recommended by the manufacturer. All other types of use are incorrect. Compliance with and strict adherence to the conditions of operation, service and repair as specified by the manufacturer also constitute essential elements of the intended use.

This machine should be operated, serviced and repaired only by persons who are familiar with its particular characteristics and who are acquainted with the relevant safety procedures.

Accident prevention regulations, all other generally recognised regulations on safety and occupational medicine, and all road traffic regulations must be observed at all times.

Any arbitrary modifications carried out to this machine may relieve the manufacturer of liability for any resulting damage or injury.

Good service

Husqvarna products are sold all over the world and ensures that you, the customer, get the best support and service. For example, before this machine was delivered it was inspected and adjusted by your dealer. See the certificate in the Service Journal in this manual.

When you need spare parts or advice on service issues, warranty terms, etc., contact:

This Operator's Manual belongs to machine with serial number:	Engine	Transmission

On the machine's rating plate you will find the following information:

- The machine's type designation.
- The manufacturer's type number.
- The machine's serial number.

State the type designation and serial number when ordering spare parts.

Service journal

Pre-delivery service

- 1 Charge the battery for 4 hours at max. 3 amp.
- 2 Attach the cutting unit to the machine, see Attaching the cutting unit.
- 3 Fit steering wheel, seat and any optional equipment.
- 4 Check and adjust tyre pressure (60 Kpa, 0.6 bar, 9 PSI).
- 5 Check that the right amount of oil is in the engine.
- 6 Connect battery.
- 7 Fill with fuel and start engine.
- 8 Check that machine does not move in neutral.
- 9 Check:
 - Forward drive.
 - Reverse drive.
 - Operation of blades.
 - Seat safety switch.
 - Lif lever safety switch.
 - Safety switch for parking brake.
 - Check engine speed. See the Technical data section.
- 10 Tell customer about:
 - Needs and benefits of following the service schedule.
 - Servicing and the influence of this journal on the second-hand value of the machine.
 - Range of applications for BioClip.
 - Complete proof of sale etc.

Pre-delivery service carried out. No outstanding problems. Certified:

Date, mileage, stamp, signature

After the first 8 hours

- 1 Change engine oil

KEY TO SYMBOLS

Symbols

These symbols are on the machine and in the instructions.

WARNING! Careless or incorrect use can result in serious or fatal injury to the operator or others.

Please read the operator's manual carefully and make sure you understand the instructions before using the machine.

Always wear:

- Approved hearing protection

This product is in accordance with applicable EC directives.

Reverse

Neutral

Fast

Slow

Stop the engine.

Battery

Choke

Fuel

Oil level

Cutting height

Backwards

Forwards

Ignition



Warning: rotating parts. Keep hands and feet clear.

Clutch in

Clutch out

Parking brake

Brake

Clutch

Noise emission to the environment according to the European Community's Directive. The machine's emission is specified in chapter Technical data and on label.

Rotary blades Keep hands and feet away from under the hood when the engine is running

Never drive across a slope

Never use the machine if persons, especially children, or animals, are in the vicinity

Never carry passengers on the machine or equipment

Drive very slowly if no cutting unit is fitted

The cutting deck must be fitted at full speed.

Switch off the engine and take off the ignition cable before repairs or maintenance



SAFETY INSTRUCTIONS

Safety instructions

These instructions are for your safety. Read them carefully.

Insure your Rider

- Check the insurance coverage for your new Rider.
- Contact your insurance company.
- You should have fully comprehensive insurance including: third party, fire, damage, theft and liability

General use

- Read all the instructions in this operator's manual and on the machine before you start it. Ensure you understand them and then observe them.

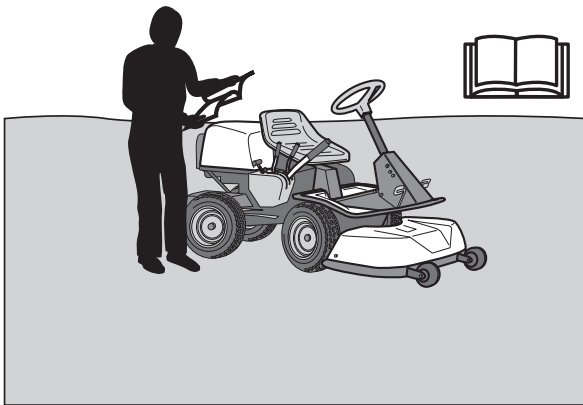

WARNING! This machine produces an electromagnetic field during operation. This field may under some circumstances interfere with active or passive medical implants. To reduce the risk of serious or fatal injury, we recommend persons with medical implants to consult their physician and the medical implant manufacturer before operating this machine.

- Learn how to use the machine and its controls safely and learn to how to stop quickly. Also learn to recognize the safety decals.
- Only allow the machine to be used by adults who are familiar with its use.
- Make sure nobody else is in the vicinity of the machine when you start the engine, engage the drive or drive off.
- Clear the area of objects such as stones, toys, wires, etc. that may become caught in the blades and be thrown out.



- Stop the engine and prevent the engine from being started until you have cleaned the outlet channel.
- Look out for the ejector and do not direct it towards anyone.
- Stop the engine and prevent it from starting before you clean the cutting unit.
- Remember that the driver is responsible for dangers or accidents.
- Never carry passengers. The machine is only intended to be used by one person.



- Always look downwards and backwards before and while reversing. Keep watch for both large and small obstacles.
- Slow before cornering.
- Switch off the blades when you are not mowing.
- Take care when rounding a fixed object, so that the blades do not hit it. Never run the machine over foreign objects.



WARNING! This machine can sever hands and feet as well as throw objects. Failure to observe the safety instructions can result in serious injuries.



WARNING! Engine exhaust, some of its constituents and certain vehicle components contain or emit chemicals considered to cause cancer, birth defects or other reproductive impairment. The engine emits carbon monoxide, which is a colourless, poisonous gas. Do not use the machine in enclosed spaces.

- Only use the machine in daylight or in other well-lit conditions. Keep the machine at a safe distance from holes or other irregularities in the ground. Pay attention to other possible risks.
- Never use the machine if you are tired, if you have consumed alcohol, or if you are taking other drugs or medication that can affect your vision, judgement or co-ordination.
- Keep an eye on the traffic when working close to a road or when crossing it.
- Never leave the machine unsupervised with the engine running. Always stop the blades, apply the parking brake, stop the engine and remove the keys before leaving the machine.

SAFETY INSTRUCTIONS

- Never allow children or other persons not trained in the use of the machine to use or service it. Local laws may regulate the age of the user.



WARNING! You must use approved personal protective equipment whenever you use the machine. Personal protective equipment cannot eliminate the risk of injury but it will reduce the degree of injury if an accident does happen. Ask your dealer for help in choosing the right equipment.

- Use hearing protection to minimise the risk of hearing impairment.



- Never wear loose fitting clothes that can catch in moving parts.
- Never use the machine when barefoot. Always wear protective shoes or protective boots, preferably with steel toes.



- Make sure that you have first aid equipment close at hand when using the machine.



Driving on slopes

Driving on slopes is one of the operations where the risk of the driver losing control of the machine or of it overturning is the greatest; this can result in serious injury or death. All slopes demand extra care. If you cannot reverse up a slope or if you feel unsure, do not mow it.

IMPORTANT INFORMATION

Do not drive down slopes with the unit raised.

This is what you do

- Remove obstacles such as stones, branches, etc.
- Mow upwards and downwards, not sideways.

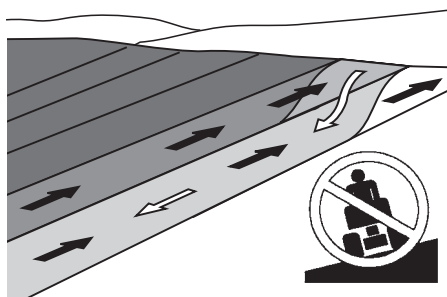

- Do not use the machine on ground that slopes more than 10°.
- Take extra care if any attachments are fitted that can change the stability of the machine.
- Avoid starting or stopping on a slope. If the tyres start to slip, stop the blades and drive slowly down the slope.
- Always drive smoothly and slowly on slopes.
- Do not make any sudden changes in speed or direction.
- Avoid unnecessary turns on slopes, if necessary, turn slowly and gradually downwards if possible. Drive slowly. Do not turn the wheel sharply.

Rider 111B5: Select a low gear so that you will not need to stop to change gear. The machine engine-brakes even better in low gear.

- Watch out for and avoid driving over furrows, holes and bumps. It is easier for the machine to overturn on uneven ground. Tall grass can hide obstacles.



- Do not mow too close to edges, ditches or banks. The machine can suddenly overturn if one wheel comes over the edge of a steep slope or a ditch, or if an edge gives way.
- Do not mow wet grass. It is slippery, and tyres can lose their grip so that the machine skids.
- Do not try to stabilize the machine by putting your foot on the ground.
- When cleaning the chassis, the machine may never be driven near verges or ditches.
- When mowing, keep away from bushes and other materials in order to avoid a heating effect.

SAFETY INSTRUCTIONS

Children

- Serious accidents may occur if you fail to be on your guard for children in the vicinity of the machine. Children are often attracted to the machine and mowing. Never assume that children will remain where you last saw them.
- Keep children away from the area to be mowed and under close supervision by another adult.
- Keep an eye out and shut off the machine if children enter the work area.
- Before and during reversing procedures, look behind you and down for small children.
- Never allow children to ride along. They can fall off and seriously injure themselves or be in the way for safe manoeuvring of the machine.
- Never allow children to operate the machine.

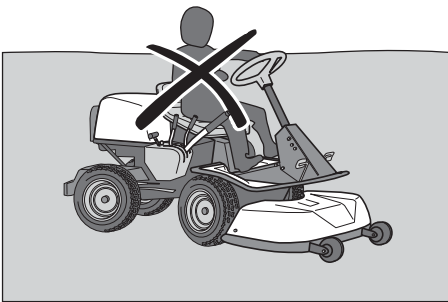

- Be particularly careful near corners, bushes, trees or other objects that block your view.

Maintenance

- Stop the engine. Prevent starting by removing the ignition cable from the spark plug or remove the ignition key before making any adjustments or carrying out maintenance.
- Never fill the fuel tank indoors.



- Petrol and petrol fumes are poisonous and extremely flammable. Be especially careful when handling petrol, as carelessness can result in personal injury or fire.
- Only store fuel in containers approved for the purpose.
- Never remove the fuel cap and fill the petrol tank while the engine is running.
- Allow the engine to cool before refuelling. Do not smoke. Do not fill petrol in the vicinity of sparks or naked flames.
- Handle oil, oil filters, fuel and the battery carefully, of environmental considerations. Follow the local recycling requirements.

- Electrical shocks can cause injuries. Do not touch cables when the engine is running. Do not test the ignition system with your fingers.



WARNING! The engine and the exhaust system become very hot during operation. Risk of burn injuries if touched. When mowing, keep away from bushes and other materials in order to avoid a heating effect.

- If leaks arise in the fuel system, the engine must not be started until the problem has been resolved.
- Store the machine and fuel in such a way that there is no risk that leaking fuel or fumes can cause any damage.
- Check the fuel level before each use and leave space for the fuel to expand, because the heat from the engine and the sun may otherwise cause the fuel to expand and overflow.
- Avoid overfilling. If you spill petrol on the machine, wipe up the spill and wait until it has evaporated before starting the engine. If you spill on your clothing, change your clothing.
- Allow the machine to cool before performing any actions in the engine compartment.



WARNING! The battery contains lead and lead pollutants, chemicals that are considered to cause cancer, birth defects or other reproductive impairment. Wash your hands after touching the battery.

- Be especially careful when handling battery acid. Acid on the skin can cause serious corrosive injuries. In the event of spillage on the skin wash immediately with water.
- Acid in the eyes can cause blindness, contact a doctor immediately.
- Take care with battery maintenance. Explosive gases form in the battery. Never perform maintenance on the battery while smoking or in the vicinity of open flames or sparks. This can cause the battery to explode and cause serious injuries.

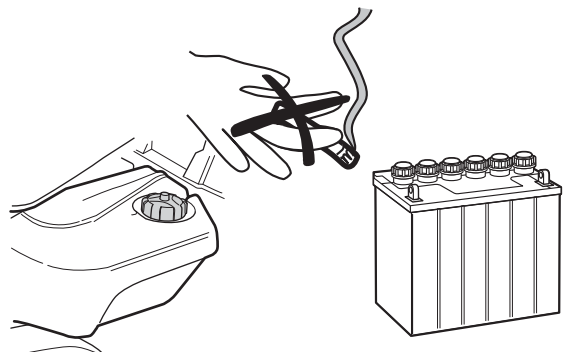

- Make sure all nuts and bolts are tightened correctly and that the equipment is in good condition.
- Do not modify safety equipment. Check regularly to be sure it works properly. The machine must not be driven if protective plates, protective covers, safety switches or other protective devices are not fitted or are defective.
- Observe the risk of injury caused by moving or hot parts if the engine is started with the engine cover open or protective cowlings removed.

SAFETY INSTRUCTIONS

- Do not change the setting of governors and avoid running the engine at excessively high revs. If you run too fast, you risk damaging the machine components.
- Never use the machine indoors or in spaces lacking proper ventilation. Exhaust fumes contain carbon monoxide, an odourless, poisonous and highly dangerous gas.

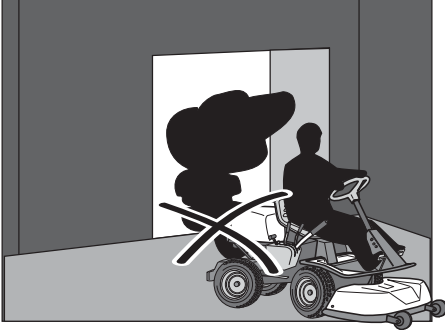

- Stop and inspect the equipment if you run over or into anything. If necessary, make repairs before starting.
- Never make adjustments with the engine running.
- The machine is tested and approved only with the equipment originally provided or recommended by the manufacturer.
- The blades are sharp and can cause cuts. Wrap the blades or wear protective gloves when handling them.
- Check regularly that the parking brake works. Adjust and maintain as required.
- Reduce the risk of fire by removing grass, leaves and other debris that may have fastened on the machine. Allow the machine to cool before putting it in storage.

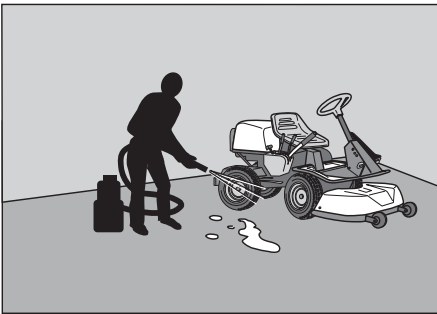

Transport

IMPORTANT INFORMATION

The parking brake is not sufficient to lock the machine during transport. Ensure you secure the machine firmly to the transporting vehicle.

- The machine is heavy and can cause serious crush injuries. Take extra care when loading it onto or off a vehicle or trailer.
- Use an approved trailer to transport the machine.
To secure the machine on the trailer, two approved tension belts and four wedge shaped wheel blocks should be used.

Engage the parking brake and tie the tension belts around stable parts on the machine, e.g. frame or rear wagon. Secure the machine by tensioning the belts towards the back and the front of the trailer respectively.

Place the wheel blocks in front of and behind the rear wheels.

- Check and observe local road traffic regulations before transporting or driving the machine on roads.

WHAT IS WHAT?

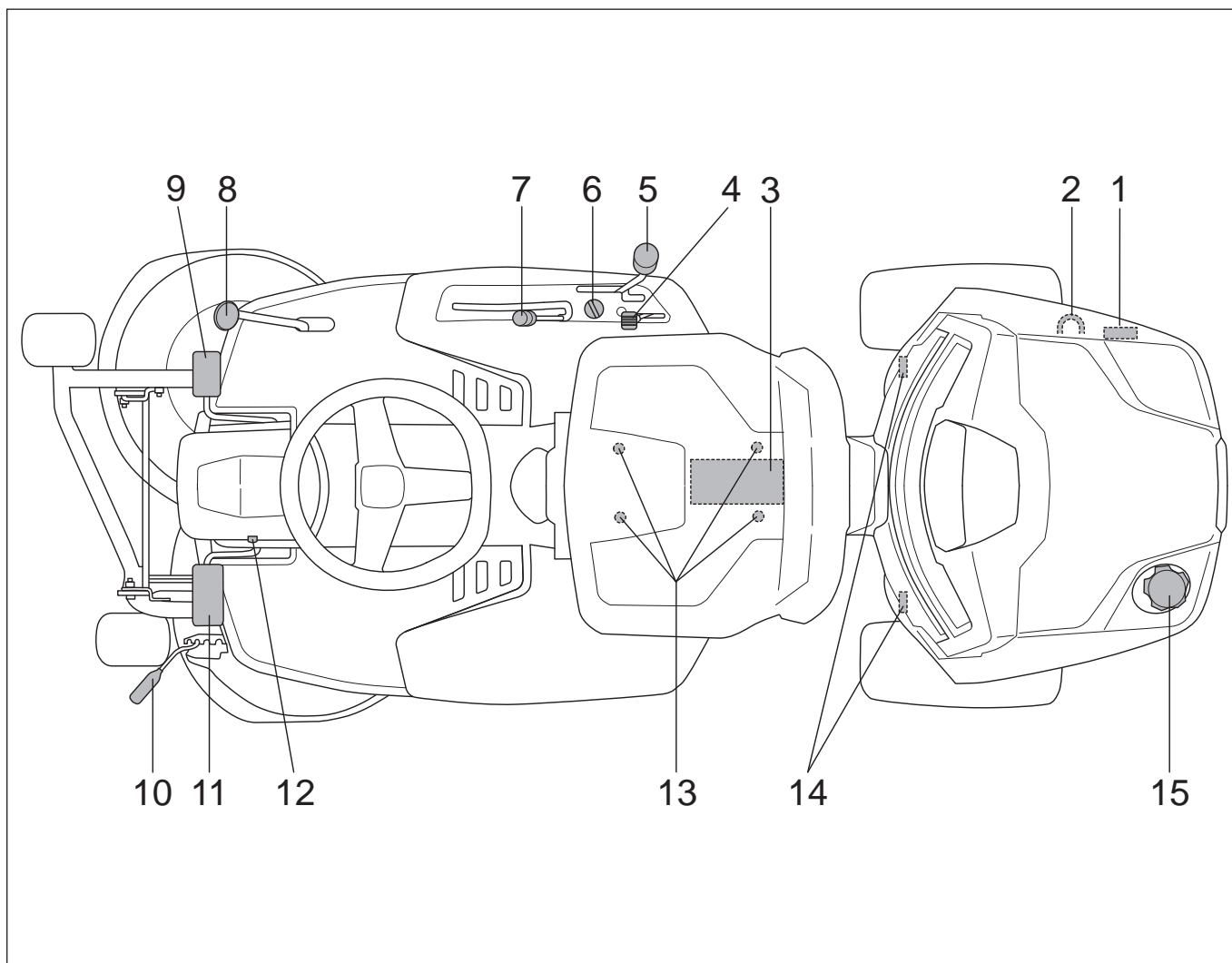

Location of the controls

- | | | | |
|---|--|----|--|
| 1 | Product and serial number plate | 9 | Speed limiter for driving forward, Rider 111B
Parking brake, Rider 111B5 |
| 2 | Lever to disengage the drive, Rider 111B | 10 | Cutting height adjustment lever |
| 3 | Battery | 11 | Parking brake, Rider 111B Clutch pedal, Rider 111B5 |
| 4 | Throttle control/choke control | 12 | Lock button for the parking brake, left side on Rider 111B,
right-hand side on Rider 111B5. |
| 5 | Gear shift lever, 111 B5 | 13 | Seat adjustment. |
| 6 | Ignition lock | 14 | Cover lock |
| 7 | Lifting lever for the cutting unit | 15 | Fuel cap |
| 8 | Speed limiter for reversing, Rider 111B | | |

PRESENTATION

Presentation

Congratulations on your choice of an excellent quality product that will give you great pleasure for many years.

Rider 111B5 has a gearbox of "inline" type with 5 forward gears and 1 backward gear.

On Rider 111B, the power transmission is handled by a hydrostatic gearbox which allows variable variation of the speed.

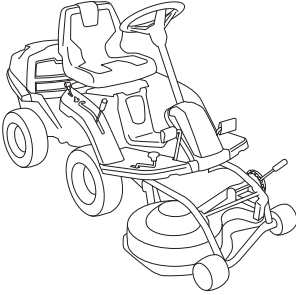

Clutch pedal Rider 111 B5

The clutch pedal disengages the engine and stops propulsion.

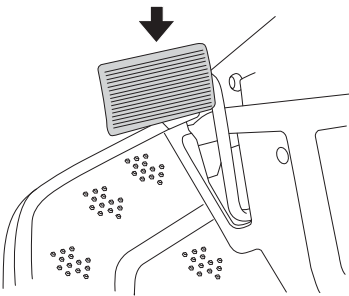

The blade drive is not affected by the clutch pedal.

Brake pedal / Parking brake

Rider 111 B5

The brake pedal activates a disc brake that is located on the gearbox and stops the drive gear. The clutch pedal should also be pressed down when braking to achieve the best braking effect.

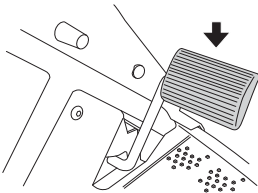

Parking brake

The parking brake is applied as follows:

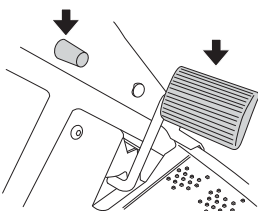

- 1 Press down the parking brake pedal.
- 2 Press in the lock button on the steering column.

- 3 Release the parking brake pedal while keeping the button pressed in.

Rider 111B5 has the brake pedal and lock button on the right hand side.

Rider 111B has the brake pedal and lock button on the left hand side.

The parking brake lock disengages automatically when the brake pedal is pressed.

Throttle and choke controls

The throttle control regulates the engine speed, and thereby also the rotation speed of the blades.

The control is also used to activate the choke. When the choke is engaged a richer fuel and air mixture is fed to the engine, which facilitates starting in the cold.

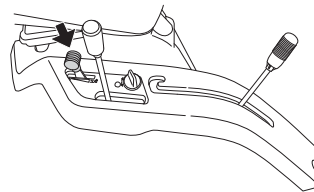

Speed limiter Rider 111B

The speed of the machine is steplessly regulated with two pedals. Pedal (1) is used to drive forwards, and pedal (2) to drive backwards.

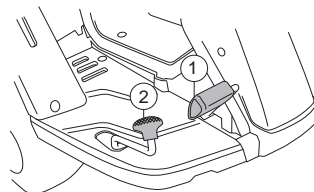

WARNING! Make sure that branches do not obstruct the pedals when mowing under bushes. Otherwise there is a risk you may lose control.

Cutting unit

The machines are equipped with a 2-blade BioClip cutting deck. The BioClip-unit, equipped with a BioClip-plug, finely chops the cuttings to fertiliser. Without the BioClip-plug the unit works in the same way as a rear ejection unit.

Lifting lever for the cutting unit

The lift lever is used to set the cutting unit in transport or mowing position.

If the lever is pulled backwards the unit is raised and the blades automatically stop rotating (transport position).

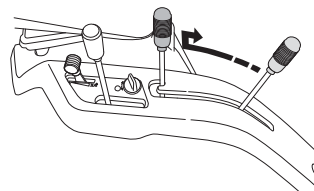

PRESENTATION

If the lever is moved forwards, the cutting deck will be lowered and the blades will automatically start to rotate (mowing position).

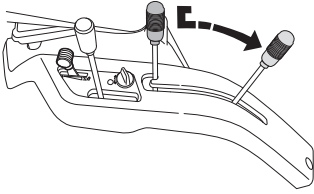

The lever can also be used to temporarily regulate the cutting height, e.g. for a small mound in the lawn.

Cutting height adjustment lever

The cutting height can be adjusted to 5 different positions with the cutting height lever.

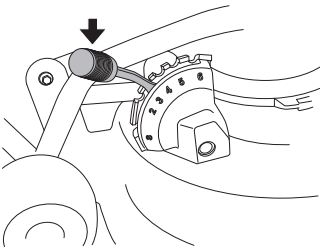

Lift up the cutting unit before adjusting the height.

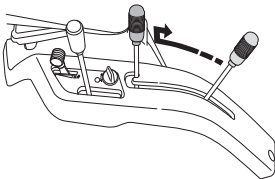

Seat

The seat has a jointed attachment on the front edge and can be tipped forward.

The seat can also be adjusted lengthways.

Loosen the bolts under the seat and adjust it forwards or backwards to the desired position.

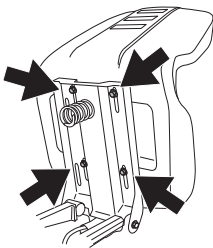

Fuelling

The engine runs on unleaded petrol with a minimum octane rating of 85 (not mixed with oil). We recommend the use of biodegradable alkylate petrol. Do not use petrol that contains methanol.

Do not fill the tank completely, leave an expansion area of at least 2.5 cm (1").

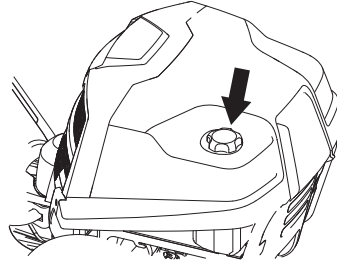

WARNING! Petrol is highly inflammable. Exercise care and refuel outdoors (see safety instructions).

IMPORTANT!

Do not use the fuel tank as a support area.

Release lever Rider 111B

The release control must be pulled out in order for the machine to be moved when the engine is shutoff. Pull the controls to the end positions, do not use an intermediate position.

- Pull out the control to disengage the drive system.

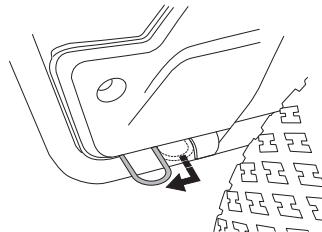

- Push in the control to engage to the drive system.

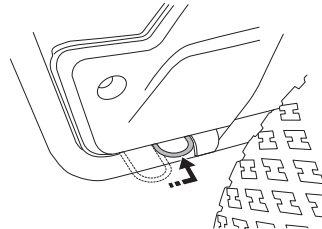

Before starting

IMPORTANT!

The air intake grille in the engine cover behind the driver's seat must not be blocked by, for example, clothing, leaves, grass or dirt.

Impaired cooling of the engine. Risk of major engine damage.

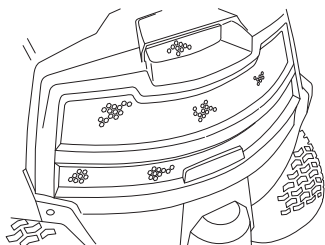

- Read the safety instructions and information concerning the placement of controls and functions before starting.
- Perform daily maintenance before starting as set out in the Maintenance schedule.

Adjust the seat to the required position.

Start the engine

- 1 **Rider 111B** Make sure that the clutch control is depressed. (Run position)

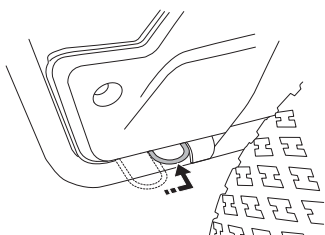

- 2 Lift up the cutting unit by pulling the lever backwards to its locked position.

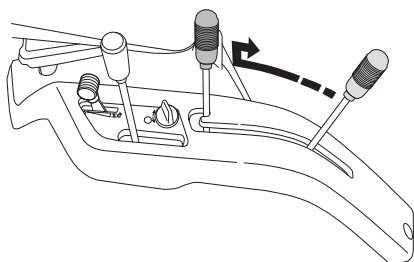

- 3 Activate the parking brake. This is done as follows:

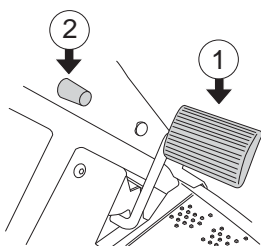

- Press down the parking brake pedal (1).
- Press in the lock button (2) on the steering column.
- Release the brake pedal while holding the button pressed.

The parking brake lock disengages automatically when the brake pedal is pressed.

Rider 111B5 has the brake pedal and lock button on the right hand side.

The engine can not be started if the parking brake is not pressed down.

- 4 Rider 111 B5

Put the gear shift lever in the "N" position (neutral).

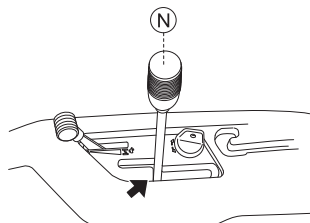

With a cold engine:

- 5 Move the throttle to position 3 (choke position). In this position the engine is fed with a richer mixture, which means the engine is easier to start.

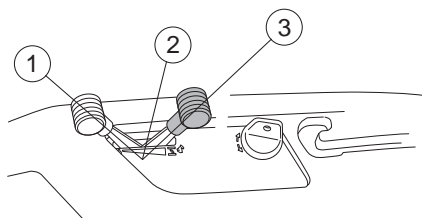

With a warm engine:

- 6 Move the throttle in between positions 1 and 2.

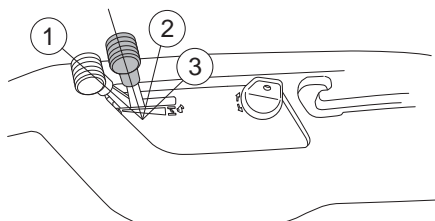

- 7 Turn the ignition key to the start position.

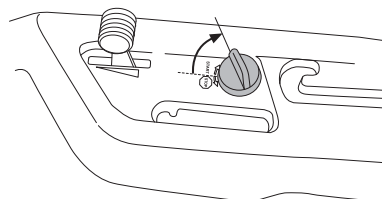

IMPORTANT INFORMATION

If the engine does not start, wait about 15 seconds before trying again. If the engine does not start wait about 1 minute before trying again.

- 8 When the engine starts release the ignition key immediately back to neutral position.

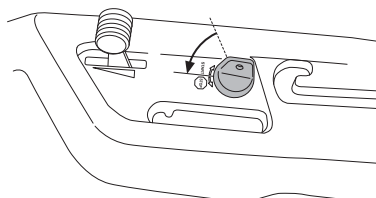

Driving

- 9 Push the choke lever gradually forward when the engine has started. Let the engine run at moderate speed or half throttle for 3-5 minutes before subjecting it to heavy load.
- 10 Set the required engine speed with the throttle control.



WARNING! Never run the engine indoors, in enclosed or poorly ventilated areas. The exhaust fumes contain toxic carbon monoxide.

Starting the engine with a weak battery

If the battery is too weak to start the engine, it should be recharged. Charge the battery for 4 hours at max. 3 amp.

When the battery is fully charged, connect the red cable to the positive pole (+pole) of the battery and the black cable to the negative pole (-pole). Ensure that the red (+) cable is drawn behind the black (-) cable.

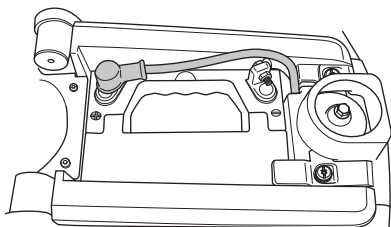

When jump leads are used for emergency starting, follow the procedure below:



IMPORTANT INFORMATION Your Rider is equipped with a 12-volt system with negative earth. The other vehicle must also have a 12-volt system with negative earth. Do not use your Rider battery to start other vehicles.

Connecting the jump leads

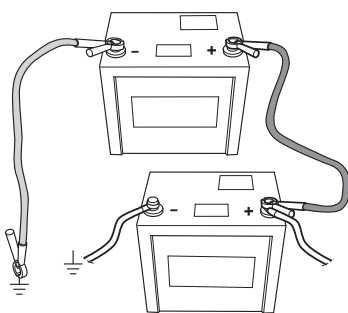

- Connect each end of the red cable to the POSITIVE pole (+) on each battery, exercise care not to short circuit any of the ends against the chassis.

Connect one end of the black cable to the NEGATIVE pole (-) on the fully charged battery.

- Connect the other end of the black cable to a good CHASSIS EARTH, away from the fuel tank and the battery.

Remove the cables in the reverse order

- The BLACK cable is removed from the chassis and then the fully charged battery.
- Finally the RED cable from both batteries.

Driving the Rider

- 1 Release the parking brake by first pressing down the parking brake pedal and then releasing it.

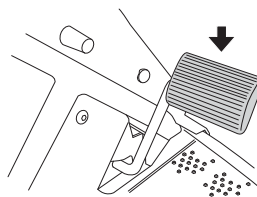

- 2 **For Rider 111B**

Carefully press down one of the pedals until the required speed is obtained. Pedal (1) is used to drive forwards, and pedal (2) to drive backwards.

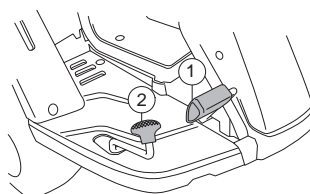

- 3 **For Rider 111B5**

Disengage the engine and select the required gear.

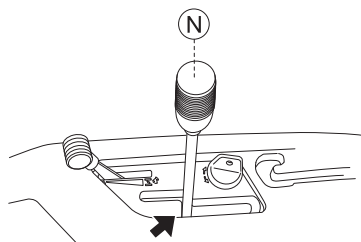

- Gears 1-4 are used for mowing
- Gears 4-5 are used for transporting

Starting can take place independent of which gear is engaged.

IMPORTANT! Gear changes between forward gears must not be made while the machine is moving.

The engine must be disengaged during each gear change.

Stop the machine before changing between forward and reverse gears, otherwise this may result in damage to the gearbox.

Never use force to engage a gear. If a gear does not engage immediately, release the clutch pedal and press it down again. Now try to engage the gear again.

- 4 Select the required cutting height (2-6) using the cutting height lever.

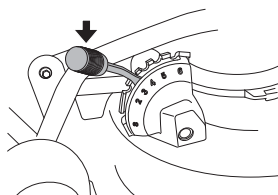

It is important that the air pressure in both front wheels is equal, 60 kPa / 0,6 bar / 8.5 PSI, to produce an even cutting height.

Driving

- 5 Lower the cutting unit.

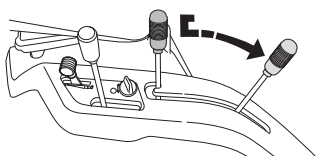

IMPORTANT INFORMATION

The life span of the drive belts is increased significantly if the engine runs at a low speed when the blades are engaged. Therefore apply full throttle first when the cutting unit has been moved to the mowing position.

Cutting tips

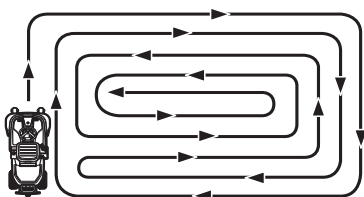

WARNING! Clear the lawn from stones and other objects which can be thrown out by the blades.

- Localise and mark stones and other fixed objects to avoid collision.
- Start with a high cutting height and reduce down until the required mowing results are obtained.
- The mowing result will be best with the highest permitted engine speed, see technical data, (the blades rotate rapidly) and low speed (the Rider moves slowly). If the grass is not too high and thick, the driving speed can be increased without noticeably depreciating the mowing result.
- The best lawns are achieved if the grass is cut often. Mowing becomes more uniform and the grass cuttings become more evenly distributed over the surface. The total time consumption is not greater since it is possible to select a higher driving speed without inferior mowing results.
- Avoid mowing a wet lawn. The mowing results are inferior since the wheels sink down into the soft lawn.
- Hose down the cutting unit with water underneath each time it is used. The cutting unit should then be put in the service position.
- When the BioClip function is used, it is very important that the mowing interval is not too long.



WARNING! Do not use the machine on ground that slopes more than 10°. Mow slopes upwards and downwards, never across. Avoid sudden changes in direction.

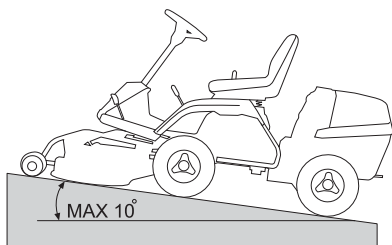

Starting on a slope, manual gearbox Rider 111 B5

- 1 Press down the parking brake pedal.
- 2 Push the throttle control to full throttle position.
- 3 Disengage the engine and select 1st gear.
- 4 Gradually release the clutch pedal.
- 5 When the engine starts to pull, release the parking brake.

Stop the engine

Preferably allow the engine to idle for a minute to obtain normal working temperature before stopping it if it has been working hard. Avoid idling the engine for long periods, as there is a risk of carbon build-up on the spark plugs.

- 1 Lift up the cutting unit by pulling the lever backwards to its locked position.

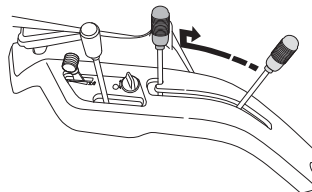

- 2 **For Rider 111B5** Pull back the throttle and move the gear shift lever to "N" – neutral position. Turn the ignition key to the "STOP".

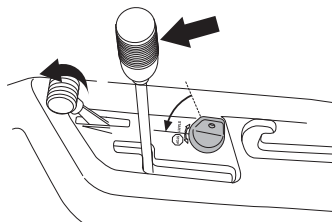

For Rider 111B Pull back the throttle and turn the ignition key to the "STOP" position.

- 3 When the Rider is at a standstill, press down the parking brake and push in the locking button.

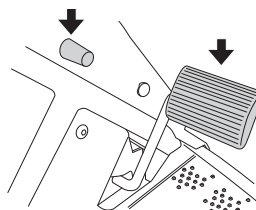

Maintenance

Maintenance schedule

The following is a list of the maintenance which should be conducted on the machine. For those points not described in this manual, visit an authorised service workshop.

Maintenance	Daily maintenance before starting	At least once a year	Maintenance interval in hours			
			25	50	100	200
Cleaning	X					
Check the engine's oil level	X					
Check the engine's cooling air intake	X					
Check the steering wires	X					
Check the brakes	X					
Check the battery	X					
Check the safety system	X					
Check nuts and screws	O					
Check for fuel and oil leakage	O					
Clean around the silencer	O					
Change engine oil ¹⁾			X	X		
Replace the air filter's prefilter ²⁾			X			
Check the cutting deck			X			
Check the air pressure in the tyres, 60 kPa/8.5 PSI.			X			
Lubricate joints and shafts ³⁾			X			
Check the V-belts			O			
Checking and adjusting of throttle wire				X		
Replace the air filter's pre-filter and paper filter ²⁾					X	
Replace the fuel filter					X	
Replace the spark plug.					X	
Check the fuel hose. Replace if necessary . ⁴⁾		O				

¹⁾First change after 8 hours. When operating with a heavy load or at high ambient temperatures, replace every 25 hours. ²⁾Clean and replace the filter more often in dusty conditions. ³⁾If the machine is used daily it should be lubricated twice a week. ⁴⁾Conducted by authorised service workshop.

X = Described in this operator's manual

O = Not described in this operator's manual



WARNING! No service procedures must be conducted on the engine or cutting unit unless:

The engine is switched off.

The ignition key is removed.

The ignition cable has been removed from the spark plug.

The parking brake is applied.

The cutting unit is disengaged.

Maintenance

Cleaning

Clean the machine directly after use. It is much easier to wash off grass cuttings before they dry.



Oily dirt can be removed using a cold degreasing agent. Spray on a thin layer.

Rinse at normal water pressure.

Do not direct the jet towards electrical components or bearings.

Do not rinse hot surfaces such as the engine and exhaust system.

Hose down the cutting unit with water underneath each time it is used.

It is recommended that you start the engine and run the mower for a short period after cleaning, so that any remaining water is blown off.

Lubricate the machine if necessary after cleaning. Carry out extra lubrication when the bearings have been exposed to a degreaser or a water jet.

IMPORTANT! Avoid using a high pressure washer or a steam cleaner.

There is a major risk of water penetrating into bearings and electrical connections. Corrosion attack can result, which will lead to running problems. Cleaning additives generally aggravate the damage.

Removing of the machine hoods

Engine cover

The engine becomes accessible for service when the engine cover is opened.

Loosen the snap locks (one on each side) and fold the cover backwards.

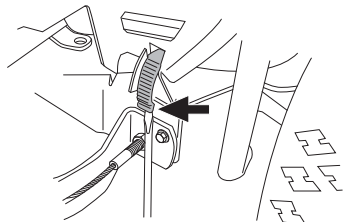

Front cover

Release the clip on the front hood and lift off the fender.

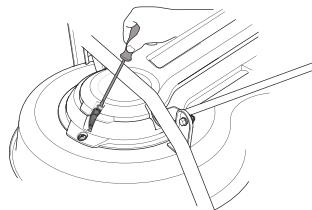

Right-hand fender

Loosen the screws holding the wing cover. On Rider 111B, the knob for the back pedal should also be removed.

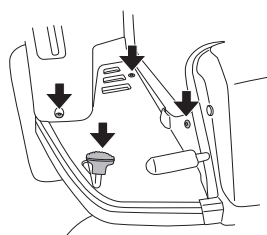

Left-hand fender

Loosen the screws holding the wing cover and lift off the cover.

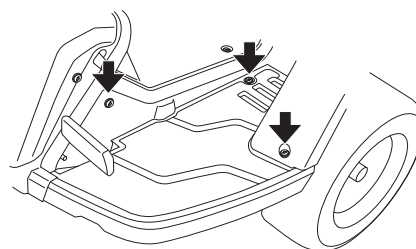

Checking and adjusting the steering wires

The steering is controlled by means of wires. These can in time become slack, which implies that the adjustment of the steering becomes altered.

Check and adjust the steering as follows:

- 1 Remove the frame plate by loosening the screws. 3 screws at the front and 2 under the seat.

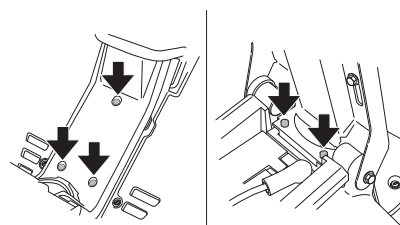

Maintenance

- 2 Check the tension of the steering wires by squeezing them together by the arrows as illustrated.

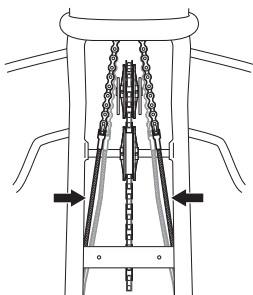

- 3 If necessary, the wires can be adjusted by tightening the adjuster nuts on each side of the steering collar. Do not over tighten the cables; they should only be drawn in towards the steering collar.

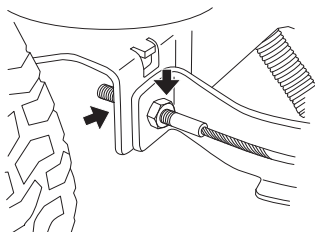

Hold the cable, for example using an adjustable wrench, so that it does not twist.

If you only tension one side the steering wheel's centre position may change.

Check the wire tension on completion of the adjustment as per item 2.

Checking the brake

The brake is a disc brake and is located on the gearbox.

Check that the brake is correctly adjusted by placing the machine on a slight downhill slope with the clutch disengaged and activating the brake.

When the machine does not stand still, the brake should be adjusted.

Adjusting the brake

- 1 Remove the protective cover.

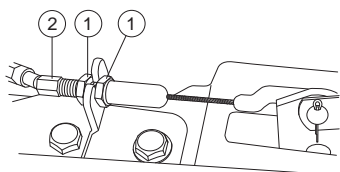
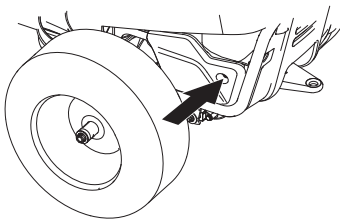

- 2 Loosen the locking nuts (1).
- 3 Tension the cable using the adjuster screw (2) until the play in the cable is taken up.
- 4 Tighten the locking nuts (1) after adjustment.

Adjusting the throttle wire

The throttle cable may need to be adjusted, if the engine does not respond as it should when accelerating, if it produces black smoke or maximum revs are not reached.

- 1 Release the clamping screw that secures the wire casing and set the choke control to maximum choke.

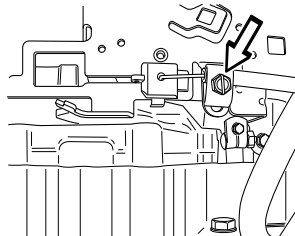

- 2 Pull the choke wire casing to the far right and tighten the clamping screw.

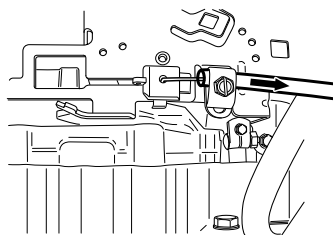

- 3 Pull back the throttle to the full throttle position and check that the choke is no longer actuated.

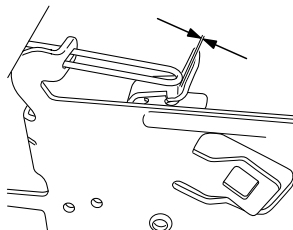

Replacing the air filter

If the engine seems to lack power or does not run smoothly this may be because the air filter is clogged. It is therefore important to replace the air filter at regular intervals (see Maintenance/Maintenance Schedule for the correct service interval).

Replace the air filter as follows:

- 1 Open the engine cover.
- 2 Pull up the handle on the air filter cover, unhook and turn towards the engine.

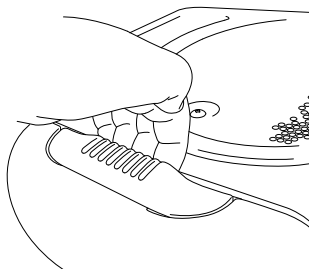

- 3 Remove the air filter cover.

Maintenance

- 4 Lift out the air filter cartridge from the fan housing.

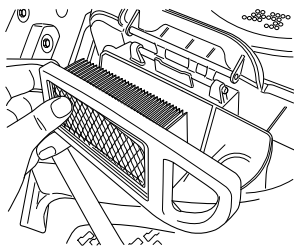

- 5 Replace the air filter cartridge, if clogged with dirt.

IMPORTANT INFORMATION

Do not use compressed air to clean the paper filter.

Do not oil the paper filter. They must be fitted dry.

- 6 Carefully lift the precleaner out of the fan housing.

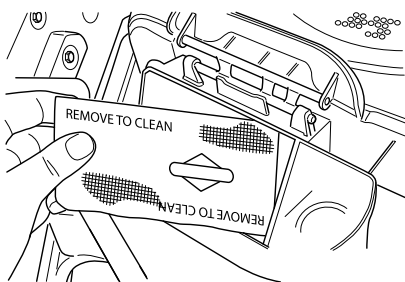

- 7 Carefully clean the fan housing so that dirt does not fall down into the carburettor.
- 8 Insert a new precleaner and air filter cartridge in the fan housing.
- 9 Align the tabs on the cover with the slits in the housing and replace the air filter cover.

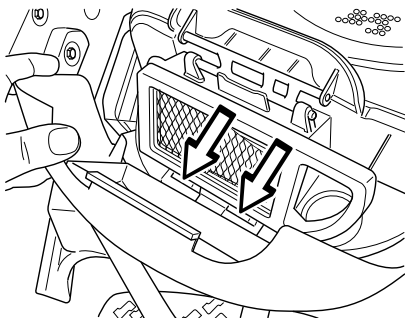

- 10 Pull the handle outwards. Secure the handle in the air filter cover and close the cover by pressing it inwards.

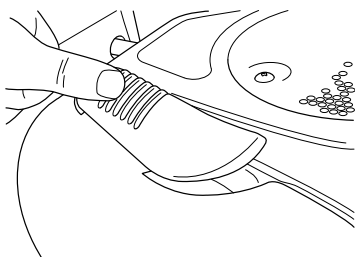

Replacement of fuel filter

Replace the fuel filter every 100 running hours (once per season) or more frequently if it is clogged.

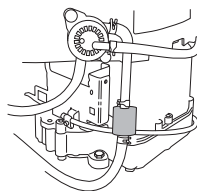

Replace the filter as follows:

- 1 Open the engine cover.
- 2 Move the hose clips away from the filter. Use a pair of flat pliers.
- 3 Pull off the filter from the hose ends.
- 4 Press the new filter into the ends of the hoses. If necessary apply liquid detergent to the ends of the filter to facilitate connection.
- 5 Push the hose clips back on the filter and tighten.

Checking the fuel pump's air filter

Check regularly that the fuel pump's air filter is free from dirt.

The filter can when necessary be cleaned with a brush.

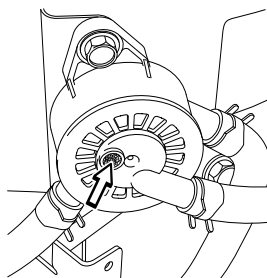

Checking the tyre pressure

The tyre pressure should be 60 kPa / 0.6 bar / 9 PSI on all wheels. In order to improve drive power, the pressure in the rear tyres can be reduced to 40 kPa / 0.4 bar / 6 PSI.

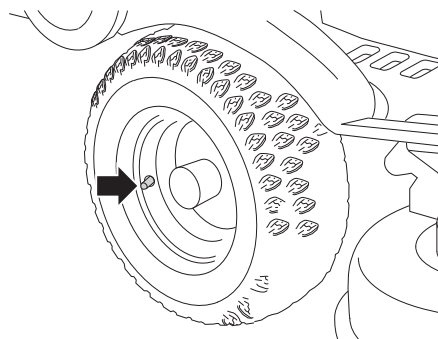

IMPORTANT INFORMATION Different tyre pressures on the front tyres will result in the blades cutting the grass at different heights.

Ignition system

The engine is equipped with an electronic ignition system. Only the spark plug requires maintenance.

Maintenance

For recommended spark plug, see Technical data.

IMPORTANT INFORMATION

Fitting the wrong spark plug type can damage the engine.

Replacing the spark plug

- 1 Remove the ignition cable shoe and clean around the spark plug.
- 2 Remove the spark plug with a 5/8" (16 mm) spark plug socket wrench.
- 3 Check the spark plug. Replace the spark plug if the electrodes are burned or if the insulation is cracked or damaged. Clean the spark plug with a steel brush if it is to be reused.
- 4 Measure the electrode gap with a gapping tool. The gap should be 0.75 mm/0.030". Adjust as necessary by bending the side electrode.
- 5 Reinsert the spark plug, turning by hand to avoid damaging the threads.

IMPORTANT INFORMATION

Inadequately tightened spark plugs can cause overheating and damage the engine. Tightening the spark plug too much can damage the threads in the cylinder head.

- 6 Tighten the spark plug, once it touches the seating, with the spark plug spanner. Tighten the spark plug so that the washer is compressed. A used spark plug should be turned 1/8 of a turn from the seated position. A new spark plug should be turned a 1/4 turn from the seated position.
- 7 Replace the ignition cable shoe.

IMPORTANT INFORMATION

Do not turn over the engine if the spark plug or ignition cable has been removed.

Fuses

The main fuse is placed in a detachable holder behind the battery under the protective cover.

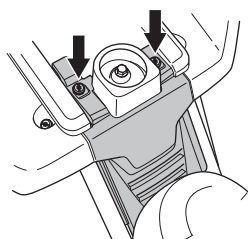

Type: Flat pin, 15 A.

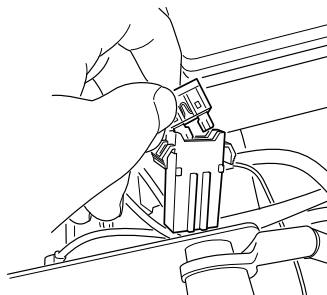

Do not use any other type of fuse when replacing.

A blown fuse is indicated by a burnt connector. Pull the fuse from the holder when replacing.

The fuse is there to protect the electrical system. If it blows again shortly after replacement, it is due to a short circuit, which must be fixed before the machine can be put into operation again.

Maintenance

Check the safety system

The machine is equipped with a safety system that prevents starting or driving under the following conditions.

The engine should only be possible to start when the cutting unit is in its raised position and the parking brake is applied.

The driver does not need to be seated in the driver's seat.

Make daily inspections to ensure that the safety system works by attempting to start the engine when one of the conditions is not met. Change the conditions and try again.

Check that the engine stops if you temporarily move out off the driver's seat while the cutting unit is lowered or the hydrostat pedals are not in the neutral position.

Start motor

Ignition system

Works

Does not work

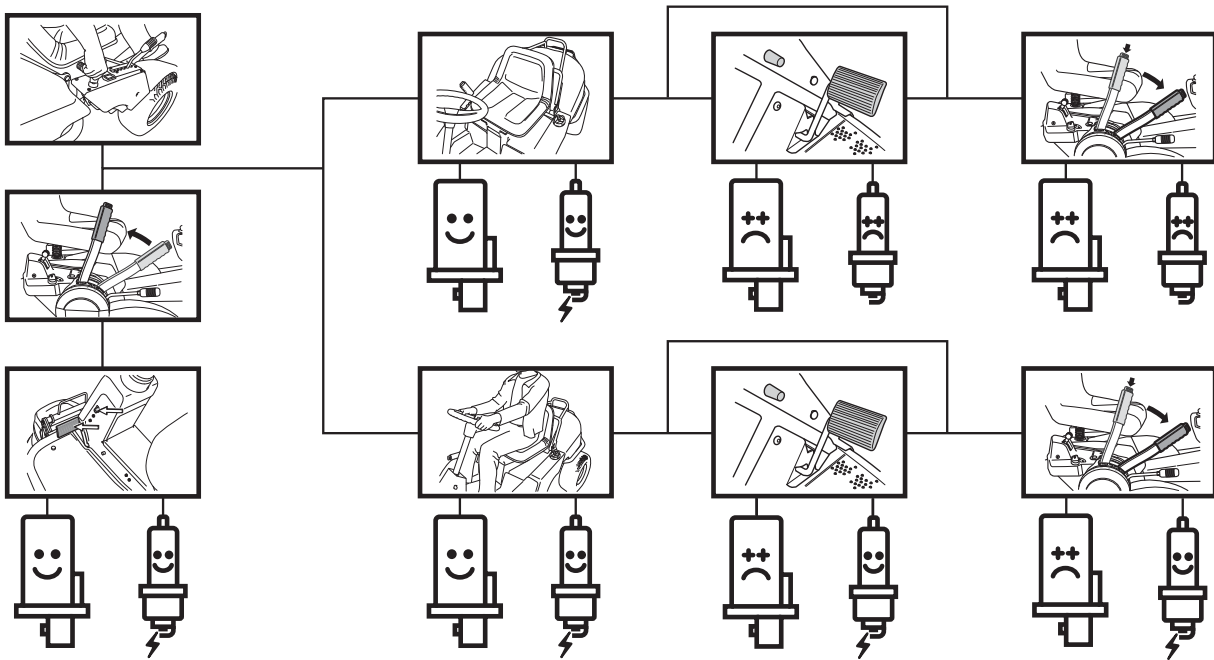

Maintenance

Checking the engine's cooling air intake

Clean the air intake grille in the engine cover behind the driver's seat.

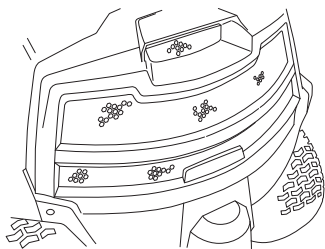

Open the engine cover.

Check that the cooling intake is free from leaves, grass and dirt.

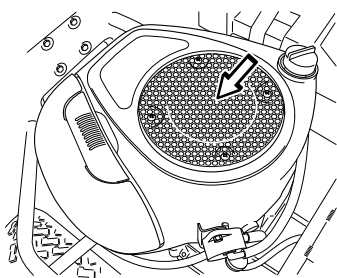

Check the air duct, located on the inside of the engine cover, ensure it is clean and does not rub against the cooling air intake.

A blocked cooling intake will interfere with the cooling of the engine, which can damage the engine.



WARNING! The cooling air intake rotates when the engine is running. Mind your fingers.

Service position for the cutting unit

The cutting deck can be removed in order to facilitate cleaning and servicing.

To remove the cutting deck proceed as follows:

- 1 Position the machine on flat ground.
- 2 Apply and lock the parking brake.

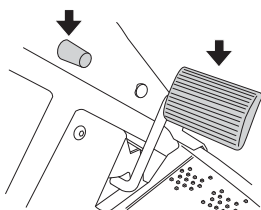

- 3 Check that the lever for setting the cutting height is in the S position.

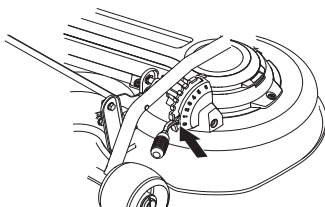

- 4 Put the lifting lever in the mowing position.

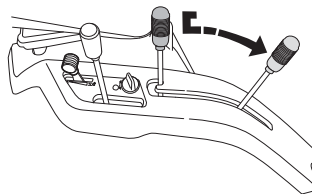

- 5 Release the clip on the front hood and lift off the fender.

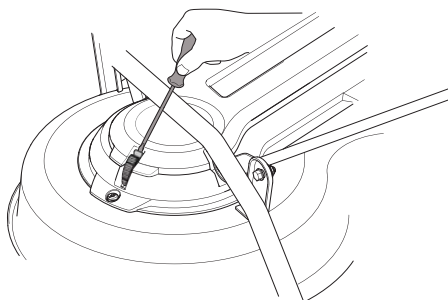

- 6 Loosen the spring on the drive belt's belt idler by loosening the handle.

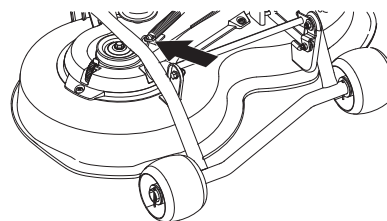

- 7 Lift of the drive belt.

- 8 Grab the upper pipe construction of the deck and pull it out.

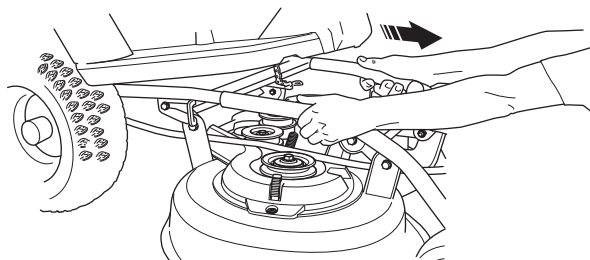

- 9 Lift off the deck and lean it against the machine or a wall.

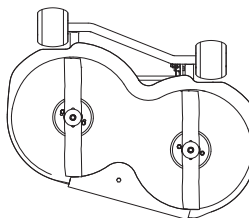

Fitting the cutting head

- 1 Place the belt under the stay of the cutting deck.

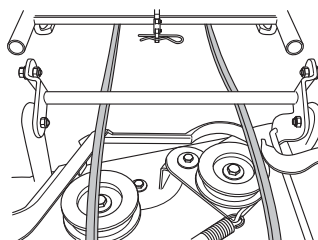

Maintenance

- 2 Fit the cutting deck's pipe together with the deck frame's pipe.

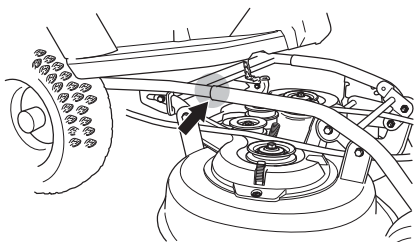

- 3 Push the cutting deck in and make sure the guide bolts fit into the grooves on the deck frame, one on each side.

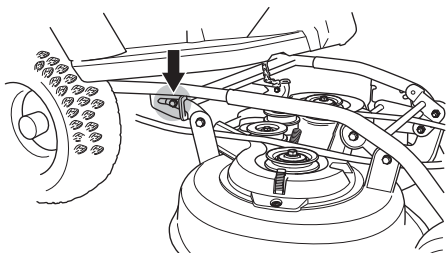

- 4 Grab the pipes and push the deck in.

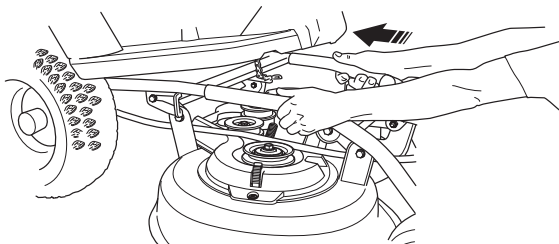

- 5 Push the deck until you feel the pipes touch bottom.

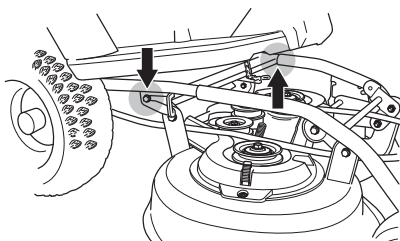

- 6 Fit the belt according to the picture.

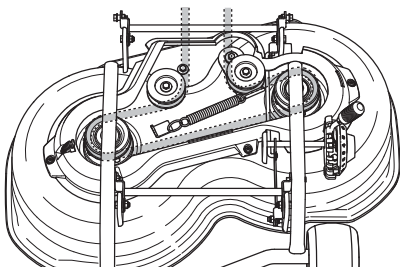

- 7 Tension the belt with the belt adjuster.

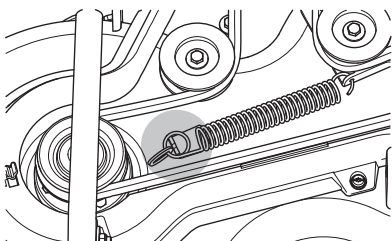

- 8 Fit the front cover.

- 9 Set the cutting deck height control in any of the positions 2-6.

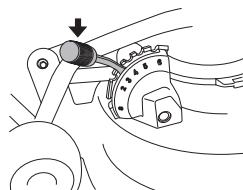

Checking the blades

To achieve the best mowing results it is important that the blades are undamaged and well-sharpened.

Check that the blades' attachment screws are tight.

- Put the unit in the service position, see Service position for the cutting unit.

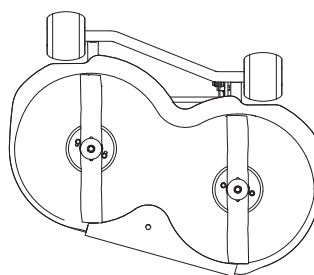

IMPORTANT INFORMATION

Replacing or sharpening the blades should be conducted by an authorised service workshop.

The blades should be balanced after sharpening.

Damaged blades should be replaced when hitting obstacles that result in a breakdown. Let the servicing dealer judge whether the blade can be repaired/ground or must be discarded.



WARNING! If the blades are cracked, whether caused by poor repair or other damage, they could break while being used. The risk increases if the blades are poorly balanced.

Removing the BioClip plug

To change a BioClip deck from the BioClip function to a cutting deck with rear ejection, remove the BioClip plug, which is located under the unit, attached with a screws.

- Put the unit in the service position, see Service position for the cutting unit.
- Loosen the screw holding the plug and remove it.

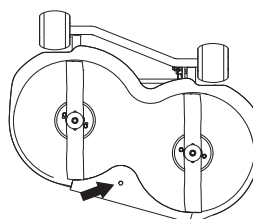

- Fit cutting unit.
- Fit the BioClip plug in the reverse order.

Lubrication

Checking the engine's oil level.

Check the oil level in the engine when the Rider stands horizontal with the engine switched off.

Open the engine cover.

Loosen the dipstick, pull it up and wipe it off.

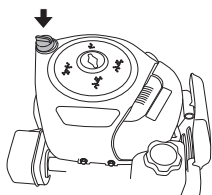

The dipstick should be **completely screwed down**

Pull the dipstick out again and read the oil level.

The oil level should be between the markings on the dipstick. If the level is approaching the ADD mark, top up the oil to the FULL mark on the dipstick.

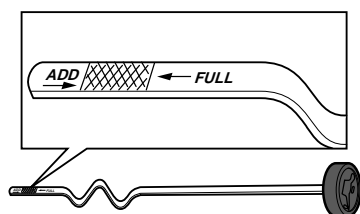

The oil is topped up through the hole the dipstick sits in.

Fill the oil slowly. Tighten the dipstick correctly before starting the engine. Start and run the engine at idling speed for approx. 30 seconds. Turn off the engine. Wait 30 seconds and check the oil level. If necessary fill so that the oil comes up to the FULL mark on the dipstick.

First and foremost use synthetic engine oil class SJ-CF 5W/30 or 10W/30 for all temperature ranges. Mineral oil SAE30, class SF-CC can be used at temperatures > +5 °C (40 °F)

Do not mix different types of oil.

Replacing the engine oil

The engine oil should be changed the first time after 8 hours running time. It should then be changed after every 50 hours of running time.

When operating with a heavy load or at high ambient temperatures, replace every 25 hours.



WARNING! Engine oil can be very hot if it is drained directly after stopping the engine. Allow the engine to cool somewhat first.

- 1 Place a container underneath the engine's left oil drain plug.
- 2 Remove the dipstick. Remove the drain plug from the engine's left side.

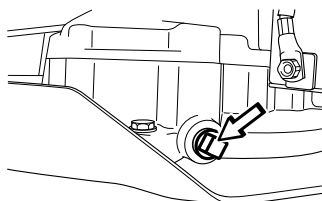

- 3 Let the oil run out into the container.

- 4 Fit the drain plug and tighten it.
- 5 Fill with oil up to the "FULL" mark on the dipstick. The oil is topped up through the hole the dipstick sits in. See Checking the engine's oil level for filling instructions.

The engine holds 1.5 litres (1.6 USqt) when the oil filter is not replaced and 1.7 litres (1.8 USqt) of oil when the oil filter is replaced.

- 6 Run the engine warm, then check that there is no leakage from the oil plug.

IMPORTANT INFORMATION

Used engine oil is a health hazard and must not be disposed of on the ground or in nature; it should always be disposed of at a workshop or appropriate disposal location.

Avoid skin contact; wash with soap and water in case of spills.

Lubricating the front wheel bearings

The front cover and wing covers must be removed on Rider with rear ejection, so that the tubular loop can be lifted to remove the wheel.

- 1 Remove the plastic cover that covers the centre of the wheel.

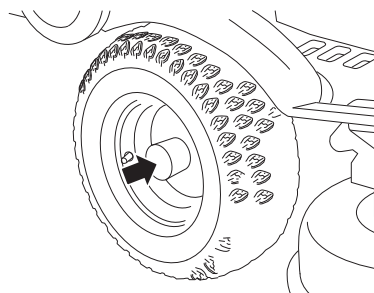

- 2 Remove the circlip and washer on the front wheel axle.
- 3 Lift off the wheel.
- 4 Lubricate the stub axle with molybdenum disulphide grease*.
- 5 Assemble the parts in the reverse order.

IMPORTANT INFORMATION

Check that the circlip enters the groove correctly.

*Grease from well-known brand names (petrochemical companies, etc.) usually maintains a good quality. The most important property is that the grease provides good protection against corrosion.

General lubrication

All joints and bearings are lubricated using molybdenum disulphide grease during manufacture. Continue to lubricate using the same type of grease *. Lubricate the steering and control wires using engine oil.

Carry out this lubrication regularly.

*Grease from well-known brand names (petrochemical companies, etc.) usually maintains a good quality. The most important property is that the grease provides good protection against corrosion.

Troubleshooting schedule

Problem	Procedure
Engine does not start	There is no fuel in the fuel tank Spark plug defective Faulty spark plug connections or interchanged cables Dirt in the carburettor or fuel line Starter motor does not turn over the engine
Starter motor does not turn over the engine	Battery flat Bad contact between the cable and battery Lift lever for cutting unit in wrong position Main fuse blown. This fuse is in front of the battery, under the battery cover. Ignition lock faulty Brake not activated. Faulty starter motor
Engine does not run smoothly	Faulty spark plug. Carburettor incorrectly set Air filter clogged Fuel tank vent blocked Ignition key defective Dirt in the carburettor or fuel line Choking or incorrectly adjusted throttle cable
Engine seems to have no power	Air filter clogged Faulty spark plug. Dirt in the carburettor or fuel line Carburettor incorrectly set Choking or incorrectly adjusted throttle cable
Engine overheats	Engine overloaded Air intake or cooling flanges blocked Fan damaged Too little or no oil in engine Ignition defective Faulty spark plug.
Battery does not charge	One or more battery cells faulty Poor contact on the battery terminal cable connectors
Machine vibrates	Blades are loose Engine is loose One or more blades unbalanced, caused by damage or poor balancing after sharpening
Uneven mowing	Blades blunt Cutting unit skew Long or wet grass Grass blockage under hood Different tyre pressures on right and left sides Over-speeding Engine speed too low Drive belt slipping

Storage

Winter storage

At the end of the season, or if the machine is going to stand idle for more than 30 days, it should immediately be made ready for storage. Fuel which is left to stand for long periods (30 days or more) can leave tacky deposits which can block the carburettor and interfere with the engine.

Fuel stabiliser is an acceptable alternative to avoid tacky deposits during storage. If alkylate petrol (Aspen) is used stabiliser is not necessary since this fuel is stable. However, one should avoid changing from standard to alkylate petrol since sensitive rubber parts can harden. Add stabiliser to the fuel in the tank or the storage container. Always use the mixing ratios indicated by the manufacturer. Run the engine for at least 10 minutes after adding the stabiliser so that it will reach the carburettor. Do not empty the fuel tank and carburettor if stabiliser has been added.



WARNING! Never place an engine with fuel in the tank indoors or in poorly ventilated areas where petrol fumes can come into contact with naked flames, sparks or pilot flames in boilers, hot water heaters, drying cabinets, etc. Exercise caution when handling fuel. It is highly inflammable, and careless use can cause serious injury and damage to property. Drain off the fuel in an approved container outdoors and well clear of naked flames. Never use petrol for cleaning purposes. Use degreasing agents and hot water instead.

To prepare the machine for storage follow these instructions:

- 1 Carefully clean the machine, especially under the cutting unit. Touch-up paint damage to avoid rust.
- 2 Inspect the machine for worn or damaged parts and tighten loose screws and nuts.
- 3 Change the engine oil, and take care of the waste oil.
- 4 Empty the fuel tank. Start the engine and run it until the carburettor is emptied of fuel.
- 5 Remove the plugs and pour about a tablespoon of engine oil into each cylinder. Pull round the engine to distribute the oil and screw the plugs back on.
- 6 Grease all grease nipples, joints and axles.
- 7 Remove the battery. Clean it, charge it, and store it in a cool place.
- 8 Store the machine in a clean and dry place and cover it over for extra protection.

Guard

There is a cover to protect your machine during storage or transport. Contact your dealer for a demonstration

Service

Low season is the most suitable time to perform a service or overhaul of the machine in order to ensure high function safety during high season.

When ordering spare parts state your machine's purchase year, model, type, and serial number.

Always use genuine parts.

Annual inspection or tuning by an authorised service workshop is a good way of getting the best out of your machine the next season.

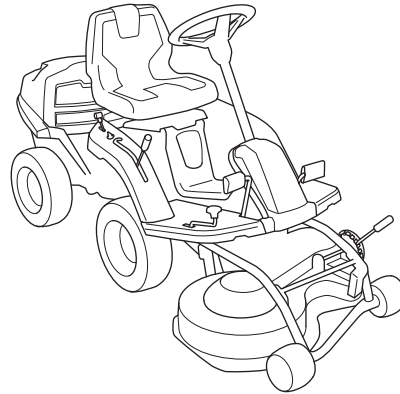

TECHNICAL DATA

	Rider 111 B5	Rider 111B
Dimensions		
Length without cutting unit, mm/ft	1734/5.69	1734/5.69
Length with cutting unit, mm/ft	2100/6.89	2100/6.89
Width without cutting unit, mm/ft	785/2.56	785/2.56
Width with cutting unit, mm/ft	883/2.90	883/2.90
Height, mm/ft	1084/3.56	1084/3.56
Operating weight with cutting deck, kg/lb	165/364	165/364
Wheel base, mm/ft	800/2.62	800/2.62
Tyre dimensions	155/50-8	155/50-8
Air pressure, rear - front, kPa / bar / PSI	60 (0,6/8,5)	60 (0,6/8,5)
Max. gradient	10°	10°
Engine		
Brand / Model	Briggs & stratton/2158	Briggs & stratton/2158
Nominal engine output, kW (see note 1)	6,8	6,8
Displacement, cm ³ /cu.in	344/21	344/21
Max. motor speed, r/min	3000 ± 100	3000 ± 100
Fuel, minimum octane grade lead-free	85	85
Fuel tank capacity, litre	2,65	2,65
Oil, class SJ-CF	SAE 5W/30 or SAE 10W/30	SAE 5W/30 or SAE 10W/30
Oil tank capacity, litre/USqt	1,4/1,5	1,4/1,5
Starting	Electric starter	Electric starter
Electrical system		
Type	12 V, negative earthed	12 V, negative earthed
Battery	12 V, 20 Ah	12 V, 20 Ah
Spark plug	Champion QC12YC	Champion QC12YC
Electrode gap, mm/inch	0,75/0,030	0,75/0,030
Main fuse	Flat pin, 15 A.	Flat pin, 15 A.
Noise emissions and cutting width (see note 2)		
Sound power level, measured dB(A)	98	98
Sound power level, guaranteed dB(A)	99	99
Cutting width, cm/inch	85/33,5	85/33,5
Sound levels (see note 3)		
Sound pressure level at the operators ear, dB(A)	86	86
Vibration levels (see note 4)		
Vibration level on the steering wheel, m/s ²	2,4	2,4
Vibration level in the seat, m/s ²	0,7	0,7
Transmission		
Brand	Peerless MST205	Hydrogear T2
Oil, class SF-CC	SAE 80W/90	SAE 20W/50
Number of forward gears	5	-
Number of reverse gears	1	-
Forward speed, km/h.	0-7	0-7
Reverse speed, km/h	0-3	0-5
Cutting unit		
Type	BioClip unit	BioClip unit
Cutting heights, 5 positions, mm/inch	25-70 / 1-2 3/4	25-70 / 1-2 3/4
Blade length, mm/inch	430/17	430/17

Note 1: The power rating of the engine indicated is the average net output (at specified rpm) of a typical production engine for the engine model measured to SAE standard J1349/ISO1585. Mass production engines may differ from this value. Actual power output for the engine installed on the final machine will depend on the operating speed, environmental conditions and other values.

Note 2: Noise emissions in the environment measured as sound power (L_{WA}) in conformity with EC directive 2000/14/EC.

Note 3: Noise pressure level according to EN 836. Reported data for noise pressure level has a typical statistical dispersion (standard deviation) of 1.2 dB(A).

Note 4: Vibration level according to EN 836. Reported data for vibration level has a typical statistical dispersion (standard deviation) of 0.2 m/s² (steering wheel) and 0.8 m/s² (seat).

TECHNICAL DATA

IMPORTANT INFORMATION When the service life of this product has been served and it is no longer used it should be returned to the dealer or to an applicable station for recycling.

IMPORTANT INFORMATION We reserve the right to change specifications and designs without prior notice so as to implement improvements. Note that no legal claims are valid on the basis of information in this manual. Use only genuine parts for repairs. The warranty is not valid if non genuine parts are used.

EC-declaration of conformity (Applies to Europe only)

Husqvarna AB, SE-561 82 Huskvarna, Sweden, tel.: +46-36-146500, hereby declares that Husqvarna Rider 111B5 and Rider 111B from 2010's serial numbers and onwards (the year is clearly stated in plain text on the rating plate with subsequent serial number), complies with the requirements of the COUNCIL'S DIRECTIVE:

of May 17, 2006 "relating to machinery" **2006/42/EC**

of December 15, 2004 "relating to electromagnetic compatibility" **2004/108/EC**.

of May 8, 2000 "relating to the noise emissions in the environment" **2000/14/EC**.

Information regarding noise emissions and the mowing width, see Technical data

The following harmonised standards have been applied: **EN ISO 12100-2, EN-836**.

0404, SMP Svensk Maskinprovning AB, Fyrisborgsgatan 3, SE-754 50 Uppsala, has issued reports regarding the assessment of conformity according to annex VI of the COUNCIL'S DIRECTIVE of May 8, 2000 "relating to the noise emissions in the environment" 2000/14/EC.

The certificates have the numbers: 01/901/102

Huskvarna December 29, 2009



Claes Losdahl, Development Manager/Garden Products (Authorized representative for Husqvarna AB and responsible for technical documentation.)



**Original instructions
1153490-26**



2010-02-15