

**Operator's manual**

**136LiC**



Please read the operator's manual carefully and make sure you understand the instructions before using the machine.

**English**

# KEY TO SYMBOLS

## Symbols on the machine:

Translation of the original Swedish operating instruction.

**WARNING!** Trimmers can be dangerous! Careless or incorrect use can result in serious or fatal injury to the operator or others. It is extremely important that you read and understand the contents of the operator's manual. Please read the operator's manual carefully and make sure you understand the instructions before using the machine.



Always wear:

- Approved hearing protection
- Approved eye protection



Max. speed of output shaft, rpm



This product is in accordance with applicable EC directives.



The operator of the machine must ensure, while working, that no persons or animals come closer than 15 meters.



Always wear approved protective gloves.



Wear sturdy, non-slip boots.



Symbols on the product or its packaging indicate that this product cannot be handled as domestic waste. This product must be deposited at an appropriate recycling facility. (Applies to Europe only)



Watch out for thrown objects and ricochets.



Only use non-metallic, flexible cutting attachments, i.e. trimmer heads with trimmer cord.



Arrows which show limits for handle positioning.



Do not expose to rain.



Direct current



Noise emission to the environment according to the European Community's Directive. The machine's emission is specified in the Technical data chapter and on the label.



## Symbols on the battery and/or on the battery charger:

This product must be deposited at an appropriate recycling facility. (Applies to Europe only)

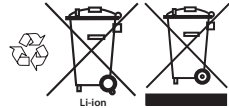

Fail-safe transformer



Use and store battery charger only indoors.



Double insulation



**Other symbols/decals on the machine refer to special certification requirements for certain markets.**

# KEY TO SYMBOLS

## Symbols in the operator's manual:

The machine is turned on and off by pressing the on and stop button. Always remove the battery to prevent the machine being started by accident.



Always wear approved protective gloves.



Regular cleaning is required.



Visual check.



Protective goggles or a visor must be worn.



Remove the battery. IMPORTANT!  
Always remove the battery to prevent the machine being started by accident.



You will find the following labels on your lawn trimmer, battery and battery charger:

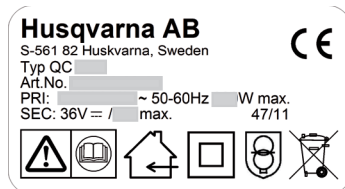
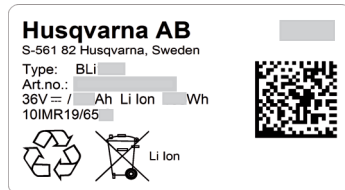
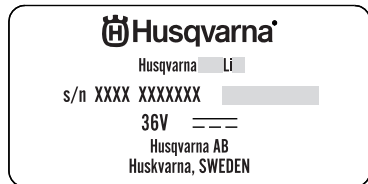

# CONTENTS

## Contents

### KEY TO SYMBOLS

Symbols on the machine: .....	2
Symbols on the battery and/or on the battery charger: .....	2
Symbols in the operator's manual: .....	3

### CONTENTS

Contents .....	4
Note the following before starting: .....	4

### INTRODUCTION

Dear Customer, .....	5
----------------------	---

### WHAT IS WHAT?

What is what? .....	6
---------------------	---

### GENERAL SAFETY PRECAUTIONS

General power tool safety warnings .....	7
Personal protective equipment .....	8
Battery and battery charger .....	8
Machine's safety equipment .....	10
Cutting equipment .....	11

### ASSEMBLY

Fitting the loop handle .....	13
-------------------------------	----

### BATTERY HANDLING

Battery status .....	14
Battery charger .....	14
Transport and storage .....	15
Disposal of the battery, battery charger and machine .....	15

### STARTING AND STOPPING

Check before starting .....	16
Connect battery to the machine .....	16
Starting and stopping .....	16

### WORKING TECHNIQUES

General working instructions .....	17
------------------------------------	----

### MAINTENANCE

Inspection and maintenance .....	20
Troubleshooting schedule .....	21
Maintenance schedule .....	22

### TECHNICAL DATA

Technical data .....	23
EC Declaration of Conformity .....	24

## Note the following before starting:

Please read the operator's manual carefully.



**WARNING! Long-term exposure to noise can result in permanent hearing impairment. Always use hearing protection.**



**WARNING! Under no circumstances may the design of the machine be modified without the permission of the manufacturer. Always use original accessories. Non-authorized modifications and/or accessories can result in serious personal injury or the death of the operator or others.**



**WARNING! A lawn trimmer can be dangerous if used incorrectly or carelessly, and can cause serious or fatal injury to the operator or others. It is extremely important that you read and understand the contents of this operator's manual.**

---

# INTRODUCTION

---

## Dear Customer,

Congratulations on your choice to buy a Husqvarna product! Husqvarna is based on a tradition that dates back to 1689, when the Swedish King Karl XI ordered the construction of a factory on the banks of the Husqvarna River, for production of muskets. The location was logical, since water power was harnessed from the Husqvarna River to create the water-powered plant. During the more than 300 years in existence, the Husqvarna factory has produced a lot of different products, from wood stoves to modern kitchen appliances, sewing machines, bicycles, motorcycles etc. In 1956, the first motor driven lawn mowers appeared, followed by chain saws in 1959, and it is within this area Husqvarna is working today.

Today Husqvarna is one of the leading manufacturers in the world of forest and garden products, with quality as our highest priority. The business concept is to develop, manufacture and market motor-driven products for forestry and gardening, as well as for the building and construction industry. Husqvarna's aim is also to be at the front edge for ergonomics, usability, security and environmental protection. That is the reason why we have developed many different features to add to our products within these areas.

We are convinced that you will appreciate with great satisfaction the quality and performance of our product for a very long time to come. The purchase of one of our products gives you access to professional help with repairs and service whenever this may be necessary. If the retailer who sells your machine is not one of our authorised dealers, ask for the address of your nearest service workshop.

It is our wish that you will be satisfied with your product and that it will be your companion for a long time. Think of this operator's manual as a valuable document. By following its content (usage, service, maintenance, etc), the life span and the second-hand value of the machine can be extended. If you sell this machine, make sure that the operator's manual is passed on to the buyer.

Thank you for using a Husqvarna product.

Husqvarna AB has a policy of continuous product development and therefore reserves the right to modify the design and appearance of products without prior notice.

# WHAT IS WHAT?

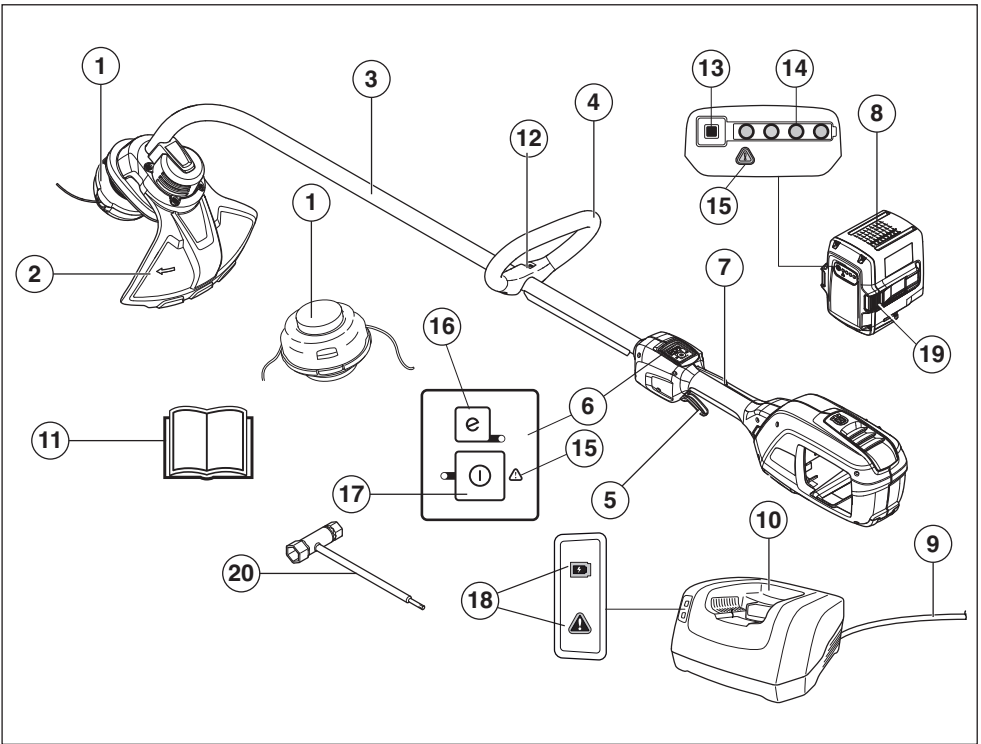

## What is what?

- |                            |                                   |
|----------------------------|-----------------------------------|
| 1 Trimmer head             | 11 Operator's manual              |
| 2 Cutting attachment guard | 12 Handle adjustment              |
| 3 Shaft                    | 13 Battery indicator button       |
| 4 Loop handle              | 14 Battery status                 |
| 5 Power trigger            | 15 Warning indicator              |
| 6 Keypad                   | 16 SavE button                    |
| 7 Power trigger lockout    | 17 Activate and deactivate button |
| 8 Battery                  | 18 Power on and warning indicator |
| 9 Cord                     | 19 Battery release buttons        |
| 10 Battery charger         | 20 Socket spanner                 |

# GENERAL SAFETY PRECAUTIONS

## General power tool safety warnings



**WARNING! Read all safety warnings and all instructions. Failure to follow the warnings and instructions may result in electric shock, fire and/or serious injury.**

**IMPORTANT! Save all warnings and instructions for future reference.**

Please read the operator's manual carefully and make sure you understand the instructions before using the machine.

### Check before starting

- Always remove the battery to prevent the machine being started by accident. Always remove the battery before any maintenance on the machine.
- Before using the machine and after any impact, check for signs of wear or damage and repair as necessary.
- Inspect the working area. Remove all loose objects, such as stones, broken glass, nails, steel wire, string, etc. that could be thrown out or become wrapped around the cutter or cutter guard.
- The machine operator must ensure that no people or animals come closer than 15 metres while working. When several operators are working in the same area the safety distance should be at least 15 metres.
- Carry out an overall inspection of the machine before use. See the maintenance schedule.

### Personal safety

- The cutting tool does not stop immediately after the machine is turned off.
- The machine is only design for trimming. Never fit metal cutting elements. Do not use the lawn trimmer for any job except that for which it is intended.
- **Stay alert, watch what you are doing and use common sense when operating a power tool. Do not use a power tool while you are tired or under the influence of drugs, alcohol or medication.** A moment of inattention while operating power tools may result in serious personal injury.
- This appliance is not intended for use by person (including children) with reduced physical, sensory or mental capabilities, or lack of experience and knowledge, unless they have been given supervision or instruction concerning use of the appliance by a person responsible for their safety. Children should be supervised to ensure that they do not play with the appliance.
- Never allow children or other persons not trained in the use of the machine and/or the battery to use or service it. Local laws may regulate the age of the user.

- Store the equipment in a lockable area so that it is out of reach of children and unauthorized persons.
- Keep hands and feet away from the cutting area at all times and especially when switching on the motor.
- **Dress properly. Do not wear loose clothing or jewellery. Keep your hair, clothing and gloves away from moving parts.** Loose clothes, jewellery or long hair can be caught in moving parts.
- Never use the machine if you are tired, if you have drunk alcohol, or if you are taking medication that could affect your vision, your judgement or your coordination.
- Wear personal protective equipment. See instructions under the "Personal protective equipment" heading.
- Turn off the machine when it has to be moved. Always remove the battery when passing the machine to another person.

### Power tool use and care

- The only accessories you can operate with this product are the cutting attachment we recommend in the technical data chapter.
- Never use a machine that has been modified in any way from its original specification. Never use the machine near explosive or flammable materials.
- Never use a machine that is faulty. Carry out the safety checks, maintenance and service instructions described in this manual. Some maintenance and service measures must be carried out by trained and qualified specialists. See instructions under the Maintenance heading.
- Only use original spare parts.
- Always ensure that ventilation openings are kept clear of debris.
- All covers, guards and handles must be fitted before starting.
- Only use the machine in daylight or in other well-lit conditions.
- Never use the machine in bad weather, for instance in fog, in rain, damp or in wet locations, strong winds, intense cold, risk of lightning, etc. Extremely hot weather may cause overheating of the machine.

### Always use common sense

It is not possible to cover every conceivable situation you can face. Always exercise care and use your common sense. Avoid all situations which you consider to be beyond your capability. If you still feel uncertain about operating procedures after reading these instructions, you should consult an expert before continuing.

# GENERAL SAFETY PRECAUTIONS

## Important



**WARNING!** This machine produces an electromagnetic field during operation. This field may under some circumstances interfere with active or passive medical implants. To reduce the risk of serious or fatal injury, we recommend persons with medical implants to consult their physician and the medical implant manufacturer before operating this machine.



**WARNING!** Never allow children to use or be in the vicinity of the machine. Since the machine is easy to start, children may be able to start it if they are not kept under full surveillance. This can mean a risk of serious personal injury. Therefore disconnect the battery when the machine is not under close supervision.

## Personal protective equipment

### IMPORTANT!

A lawn trimmer can be dangerous if used incorrectly or carelessly, and can cause serious or fatal injury to the operator or others. It is extremely important that you read and understand the content of this operator's manual.

You must use approved personal protective equipment whenever you use the machine. Personal protective equipment cannot eliminate the risk of injury but it will reduce the degree of injury if an accident does happen. Ask your dealer for help in choosing the right equipment.



**WARNING!** Listen out for warning signals or shouts when you are wearing hearing protection. Always remove your hearing protection as soon as the motor stops.

**WARNING!** There is a risk of burns as the gear housing can become very hot. Use gloves when working with the trimmer head.

### HEARING PROTECTION

Wear hearing protection that provides adequate noise reduction.



### EYE PROTECTION

Always wear approved eye protection. If you use a visor then you must also wear approved protective goggles. Approved protective goggles must comply with the ANSI Z87.1 standard in the USA or EN 166 in EU countries.



### GLOVES

Gloves should be worn when necessary, e.g. when fitting cutting attachments.



### BOOTS

Wear sturdy, non-slip boots.



### CLOTHING

Wear clothes made of a strong fabric and avoid loose clothing that can catch on twigs and branches. Always wear heavy, long pants. Do not wear jewellery, shorts sandals or go barefoot. Secure hair so it is above shoulder level.

### FIRST AID KIT

Always have a first aid kit nearby.



## Battery and battery charger

This section describes the battery and battery charger safety for your battery product.

Only use Husqvarna original batteries for Husqvarna products and only charge them in an original battery charger from Husqvarna. The batteries are software encrypted.

Use only a Husqvarna original BLi battery in your machine.



# GENERAL SAFETY PRECAUTIONS

## Battery safety

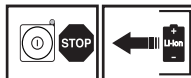

The rechargeable Husqvarna batteries, BLi, are exclusively used as a power supply for the relevant Husqvarna cordless appliances. To avoid injury, the battery must not be used as a power source for other devices.

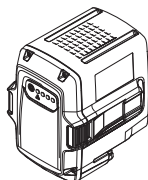

**WARNING!** Protect the battery from direct sunlight, heat or open flame. There is a risk the battery may explode if it is thrown into an open fire. There is a risk of burns and/or chemical burns.



**WARNING!** Avoid all skin contact with battery acid. Battery acid may cause skin irritation, burns or corrosive injuries. If you get acid in your eyes, do not rub but flush your eyes with plenty of water for at least 15 minutes. See a doctor. You must wash any exposed skin with copious amounts of water and soap in case of incidental contact.



**WARNING!** Never connect the battery terminal to keys, coins, screws or other metal as this may short-circuit the battery. Never insert objects into the battery's air vents.

**Unused batteries must be kept away from metal objects such as nails, coins, jewellery. Do not try to disassemble or crush the battery**

- Use the battery in surroundings where temperatures are between -10 °C and 40 °C.
- Do not expose the battery to microwaves or high pressure.
- Never clean the battery or the battery charger with water. See also instructions under the Maintenance heading.
- Store the battery out of reach of children.
- Protect the battery from rain and wet conditions.

## Battery charger safety

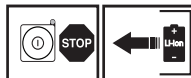

Only use Chargers, Husqvarna QC, for charging the Husqvarna replacement batteries, BLi.

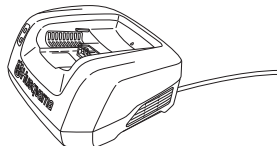

**WARNING!** Minimise the risk of electric shock or short circuit as follows:

Never insert any object into the charger's cooling slots.

Do not try to dismantle the battery charger.

Never connect the charger terminals to metal objects as this can short circuit the battery charger.

Use approved and intact wall sockets.



**WARNING!** Do not use the battery charger close to corrosive or flammable materials. Do not cover the battery charger in the event of smoke or fire. Remember the risk of fire.

- Regularly check that the battery charger connection wire is intact and that there are no cracks in it.
- Never carry the battery charger using the cord and never pull out the plug by pulling the cord.
- Keep all cables and extension leads away from water, oil and sharp edges. Make sure the cable is not jammed in doors, fences or the like. Otherwise it can cause the charger to become live. Inspect extensions cords periodically and replace if damaged.

Do not use:

- a faulty or damaged battery charger or never use a faulty, damaged or deformed battery.

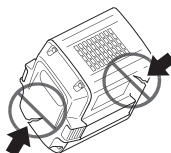

# GENERAL SAFETY PRECAUTIONS

Do not charge:

- non-rechargeable batteries in the battery charger or use them in the machine.
- the battery in the battery charger outdoors.
- the battery in the rain or in wet conditions.
- the battery in direct sunlight.

Use the battery charger only when the surrounding temperature is between 5 °C and 40 °C. Use the charger in an environment which is well ventilated, dry and free from dust.

## Machine's safety equipment

This section describes the machine's safety equipment, its purpose, and how checks and maintenance should be carried out to ensure that it operates correctly. See the "What is what?" section to locate where this equipment is positioned on your machine.

The life span or the runtime of the machine can be reduced and the risk of accidents can increase if machine maintenance is not carried out correctly and if service and/or repairs are not carried out professionally. If you need further information please contact your nearest service workshop.

### IMPORTANT!

All servicing and repair work on the machine requires special training. This is especially true of the machine's safety equipment. If your machine fails any of the checks described below you must contact your service agent. When you buy any of our products we guarantee the availability of professional repairs and service. If the retailer who sells your machine is not a servicing dealer, ask him for the address of your nearest service agent.



**WARNING! Never use a machine with faulty safety equipment. The machine's safety equipment must be checked and maintained as described in this section. If your machine fails any of these checks contact your service agent to get it repaired.**

## Keypad

Make sure the machine is switched on or off when the activate/deactivate button (1) is pressed and held (>1 sec.). The green LED (2) is lit or turned off.

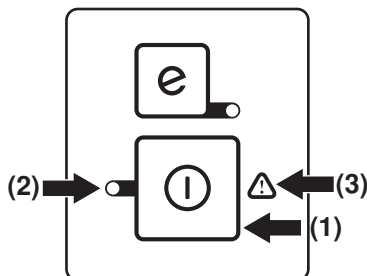

Flashing warning indicator (3) and green LED (2) is lit could indicate that:

- it is not possible to apply full power and, at the same time, activate the machine. Release the power trigger and the machine is active.
- the machine is blocked. Deactivate the machine. Remove the battery from the machine. Remove the grass or other material that is wrapped around the trimmer head.
- the machine is overloaded due to heavy trimming. Release the power trigger and the machine is active.

If the warning symbol (3) flashes, it indicates that the machine is too hot and the machine deactivates. When the machine is restored to normal temperature it is again ready to run and you can activate the machine.

Solid red warning light (3) indicates service.

## Power trigger lockout

The power trigger lockout is designed to prevent accidental operation of the power trigger. When you press the lock (1) (i.e. when you grasp the handle) it releases the power trigger (2). When you release the handle the power trigger and the power trigger lockout both move back to their original positions. This movement is controlled by two independent return springs.

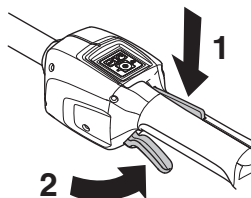

# GENERAL SAFETY PRECAUTIONS

Make sure the power trigger is locked when the power trigger lock is in its original position.

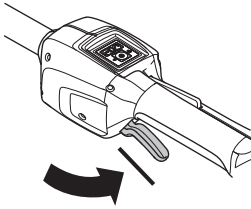

Press the power trigger and make sure it returns to its original position when you release it.

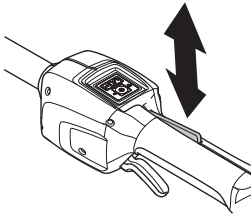

Check that the power trigger and the power trigger lockout move freely and that the return spring works properly.

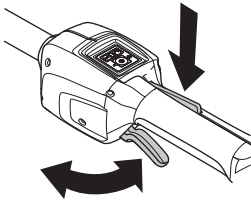

See instructions under the heading Start. Start the machine and apply full power. Release the power trigger and check that the cutting attachment stops and remain at a standstill.

## Cutting attachment guard



This guard is intended to prevent loose objects from being thrown towards the operator. The guard also protects the operator from accidental contact with the cutting attachment.

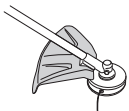

Check that the guard is undamaged and not cracked. Replace the guard if it has been exposed to impact or is cracked.

Always use the recommended guard for the cutting attachment you are using. See chapter on Technical data.



**WARNING!** Never use a cutting attachment without an approved guard. See the chapter on Technical data. If an incorrect or faulty guard is fitted this can cause serious personal injury.



**WARNING!** This machine is renowned for its low vibration load. Overexposure to vibration can lead to circulatory damage or nerve damage in people who have impaired circulation. Contact your doctor if you experience symptoms of overexposure to vibration. These symptoms include numbness, loss of feeling, tingling, pricking, pain, loss of strength, changes in skin colour or condition. These symptoms normally appear in the fingers, hands or wrists.

## Cutting equipment

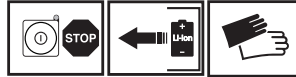

This section describes how to choose and maintain your cutting equipment in order to:

- Obtain maximum cutting performance.
- Extend the life of cutting equipment.

### IMPORTANT!

Only use cutting attachments with the guards we recommend! See the chapter on Technical data.

Refer to the instructions for the cutting attachment to check the correct way to load the line and the correct line diameter.

Always remove the battery before you work on any part of the cutting equipment. It continues to rotate even after the throttle control has been released. Check that the cutting equipment has stopped completely and remove the battery before you start any work on it.

# GENERAL SAFETY PRECAUTIONS

## Trimmer head



**WARNING!** Always use recommended trimmer line. See technical data. Failure to follow this instruction may cause personal injury.

### IMPORTANT!

Always ensure the trimmer line is wound tightly and evenly around the drum, otherwise the machine will generate harmful vibration.

- Only use the recommended trimmer heads and trimmer lines. These have been tested by the manufacturer to suit a particular motor size. This is especially important when a fully automatic trimmer head is used. Only use the recommended cutting attachment. See the chapter on Technical data.

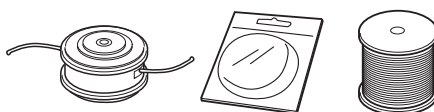

- Smaller machines generally require small trimmer heads and vice versa. This is because when clearing using a cord the engine must throw out the cord radially from the trimmer head and overcome the resistance of the grass being cleared.
- The length of the cord is also important. A longer cord requires greater engine power than a shorter cord of the same diameter.
- Make sure that the cutter on the trimmer guard is intact. This is used to cut the cord to the correct length.
- To increase the life of the cord it can be soaked in water for a couple of days before use. This will make the cord tougher so that it lasts longer. Different line lengths can result in unnecessary vibrations. Tap the trimmer head to get correct lengths on the line.
- To increase the life of the line it can be soaked in water for a couple of days. This will make the line tougher so that it lasts longer.

# ASSEMBLY

## Fitting the loop handle

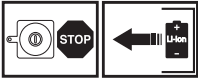

- Fit the screw into the loop handle.
- Slide the clamp into the slot in the loop handle.
- Fit the wing nut.

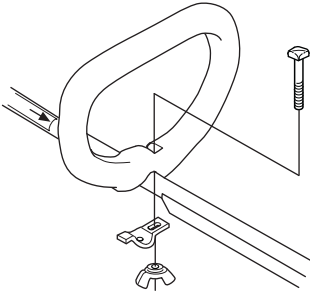

- Now adjust the trimmer to give a comfortable working position. Tighten the wing nut.

# BATTERY HANDLING

## Battery status

The display shows the battery capacity and if there are any problems with the battery. The battery capacity is displayed for 5 seconds after the machine is switched off or the battery indicator button is pressed. The warning symbol on the battery is lit when an error has occurred. See fault codes.

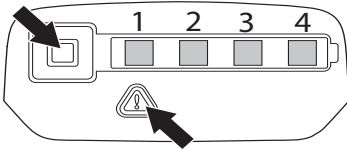

LED lights	Battery status
All LEDs are lit	Fully charged (75-100%).
LED 1, LED 2, LED 3 are lit.	The battery is 50%-75% charged.
LED 1, LED 2 are lit.	The battery is 25%-50% charged.
LED 1 is lit.	The battery is 0%-25% charged.
LED 1 flashes	The battery is empty. Charge the battery.

## Battery charger



**WARNING! Risk of electric shock and short circuiting. Use approved and intact wall sockets. Make sure that the cable is not damaged. Replace cable if it appears to be damaged in any way.**

### Connect the battery charger

- Connect the battery charger to the voltage and frequency specified on the rating plate. Put the electric plug in a earthed socket-outlet. The LED on the battery charger flashes green once.

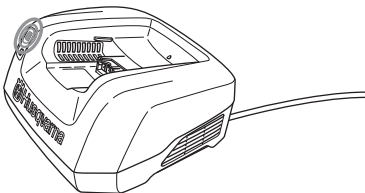

- The battery will not be charged if the battery temperature is over 50 °C. In that case the battery charger will actively cool down the battery.

### Connect the battery to the battery charger

Regularly check that the battery charger and the battery are intact. See also instructions under the Maintenance heading.

The battery must be charged before using it the first time. The battery is only 30% charged when delivered.

- Put the battery in the battery charger. Make sure that the battery is connected to the battery charger.

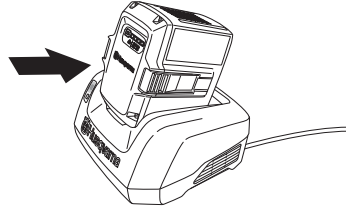

- The green charging light on the charger is lit when the battery is connected to the battery charger.
- When all LEDs are lit the battery is fully charged.

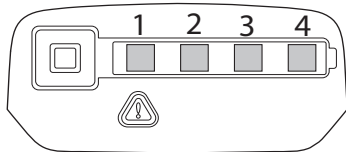

- Pull out the plug. Never jerk the power supply cable to disconnect it from the wall socket.
- Remove the battery from the battery charger.

## Charging status

Lithium-ion batteries can be charged at whatever charging level. The charging process can be cancelled or started whatever the battery's charge level is. The battery is not damaged. A fully charged battery will not lose its charge even when the battery is left in the charger.

The battery will not be charged if the battery temperature is over 50 °C.

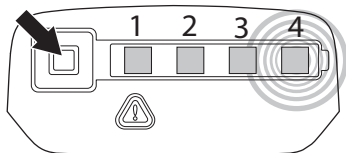

LED display	Charging status
LED 1 flashes	The battery is 0%-25% charged.
LED 1 is lit, LED 2 flashes.	The battery is 25%-50% charged.
LED 1, LED 2 are lit, LED 3 flashes	The battery is 50%-75% charged.
LED 1, LED 2, LED 3 are lit, LED 4 flashes	Battery is 75%-100% charged
LED 1, LED 2, LED 3, LED 4 are lit.	When all the LEDs are lit on the battery, it is fully charged.

# BATTERY HANDLING

## Transport and storage



- The contained lithium-ion-batteries are subject to the Dangerous Goods Legislation requirements.
- For commercial transports e.g. by third parties, forwarding agents, special requirement on packing and labeling must be observed.
- For preparation of the item being shipped, consulting an expert for hazardous material is required. Please also observe possibly more detailed national regulations.
- Tape or mask off open contacts and pack up the battery in such a manner that it cannot move around in the packing.
- Secure the machine during transport.
- Always remove the battery for storage or transport.
- Store the battery and the battery charger in a dry, moisture-free and frost-free space.
- To prevent accidents, ensure that your battery is not connected to the machine when stored.
- Do not store the battery in places where static electricity can occur. Never store the battery in a metal box.
- Store the battery and the battery charger where the temperature is between 5 °C and 45 °C and never in direct sunlight.
- Store the battery charger only in an enclosed and dry space.
- Be sure to store the battery separate from the battery charger. Store the equipment in a lockable area so that it is out of reach of children and unauthorized persons.
- Ensure the machine is cleaned and that a complete service is carried out before long-term storage.

## Disposal of the battery, battery charger and machine

Symbols on the product or its packaging indicate that this product cannot be handled as domestic waste. It must instead be submitted to an appropriate recycling station for the recovery of electrical and electronic equipment.

By ensuring that this product is taken care of correctly, you can help to counteract the potential negative impact on the environment and people that can otherwise result through the incorrect waste management of this product. For more detailed information about recycling this product, contact your municipality, your domestic waste service or the shop from where you purchased the product.

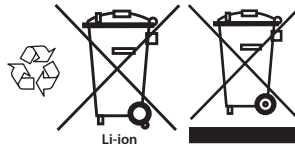

# STARTING AND STOPPING

## Check before starting



- Check the motor for dirt and cracks. Clean off grass and leaves from the engine using a brush. Gloves should be worn when necessary.
- Check that the trimmer head is completely attached to the trimmer.
- Check that the machine is in perfect working order. Check that all nuts and screws are tight.
- Check that the trimmer head and trimmer guard are not damaged or cracked. Replace the trimmer head or trimmer guard if they have been exposed to impact or are cracked.

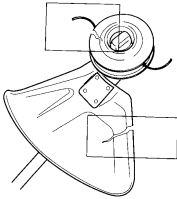

- Never use the machine without a guard nor with a defective guard.
- All covers must be correctly fitted and undamaged before you start the machine.
- Only use the machine for the purpose it was intended for.

## Connect battery to the machine

Make sure to use fully charged batteries. Use only a Husqvarna original battery in your machine. See technical data.

- Insert the battery in the machine. The battery should slide easily into the battery holder on the machine. If the battery does not slide in easily, it is not being inserted correctly. The battery will lock itself into place when you hear a click. Make sure the battery is fitted correctly to the machine.

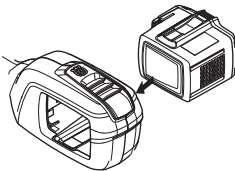

## Starting and stopping



**WARNING!** Make sure no unauthorised persons are in the working area. Otherwise there is a risk of serious personal injury. The safety distance is 15 meters.

### Starting

Turn on the machine. Press and hold the start button (>1 sec.) until the green LED is lit.

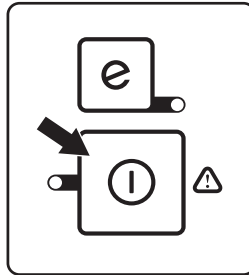

Use the power trigger to control the speed.

### Stopping

Stop the machine by releasing the power trigger or the power trigger lockout and deactivate the machine.

Remove the battery from the machine by pressing the two release buttons and pulling out the battery.

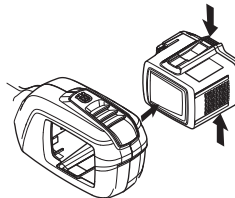

**IMPORTANT!** Always remove the battery to prevent the machine being started by accident.



# WORKING TECHNIQUES

## General working instructions

### IMPORTANT!

This section takes up the basic safety precautions for working with a lawn trimmer.

If you encounter a situation where you are uncertain how to proceed you should ask an expert. Contact your dealer or your service workshop.

Avoid all usage which you consider to be beyond your capability.



**WARNING! The machine can cause serious personal injury. Read the safety instructions carefully. Learn how to use the machine.**



**WARNING! Always remove the battery before any maintenance on the machine.**

## Basic safety rules



Wear personal protective equipment. See instructions under the "Personal protective equipment" heading.

### 1 Look around you:

- To ensure that people, animals or other things cannot affect your control of the machine.
  - To ensure that people, animals, etc., do not come into contact with the cutting attachment or loose objects that are thrown out by the cutting attachment.
  - CAUTION! Do not use the machine unless you are able to call for help in the event of an accident. Ensure that no-one comes closer than 15 metres while you are working.
- 2 Inspect the working area. Remove all loose objects, such as stones, broken glass, nails, steel wire, string, etc. that could be thrown out or become wrapped around the cutting attachment.
- 3 Never use the machine in bad weather, for instance in fog, in rain, strong winds, intense cold, etc. Working in bad weather is tiring and can lead to dangerous conditions, e.g. slippery surfaces.

## Safety instructions while working

- Make sure you can move and stand safely. Check the area around you for possible obstacles (roots, rocks, branches, ditches, etc.) in case you have to move suddenly. Take great care when working on sloping ground.



- Do not overreach. Keep proper footing and balance at all times.
- Always hold the machine with both hands. Hold the machine on the right side of your body.



- Don't force the machine. It will do the job better and with less likelihood of a risk of injury at the rate for which it was designed.
- Keep all parts of your body away from the rotating cutting attachment. Keep the cutting attachment below waist level.
- Turn off the machine when it has to be moved. Always remove the battery when passing the machine to another person.
- Never put the machine down without turning it off first and always remove the battery.
- If any foreign object is hit or if vibrations occur stop the machine immediately. Remove the battery from the machine and check that the machine is not damaged.
- If any unwanted vibrations occur, tap out new line to give the line the correct length and the vibrations should stop.

## WORKING TECHNIQUES

- Release the power trigger after each working operation to save battery power.



**WARNING!** Neither the operator of the machine nor anyone else may attempt to remove the cut material while the motor is running or the cutting attachment is rotating, as this can result in serious injury.

Turn off the machine and remove the battery before removing materials that are wound around the trimmer head as otherwise there is risk of injury. The bevel gear can get hot during use and may remain so for a while afterwards. You could get burnt if you touch it.



**WARNING!** Watch out for thrown objects. Always wear approved eye protection. Never lean over the cutting attachment guard. Stones, rubbish, etc. can be thrown up into the eyes causing blindness or serious injury.

Keep unauthorised persons at a distance. Children, animals, onlookers and helpers should be kept outside the safety zone of 15 metres. Stop the machine immediately if anyone approaches. Never swing the machine around without first checking behind you to make sure no-one is within the safety zone.

### Safety instructions after completing work

- Make sure the cutting attachment has stopped before cleaning, carrying out repairs or an inspection. Remove the battery from the machine.

### SavE mode

The machine is equipped with a battery saving function (SavE). Activate the function by pressing the SavE button. A green LED will light to indicate that the function is on.

In most cases SavE mode is the most optimum when trimming and gives longest runtime. Release the power

trigger after each working operation to save battery power.

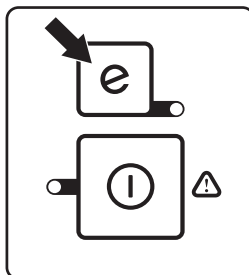

### Automatic switch off functionality

The machine is equipped with a shutdown feature that deactivates the machine if not used. The green LED and the machine will switch off after 1 minute.

### Grass trimming with a trimmer head



**WARNING!** Sometimes branches or grass get caught between the guard and cutting attachment. Always remove the battery before cleaning.

### Trimming

- Hold the trimmer head just above the ground at an angle. It is the end of the cord that does the work. Let the cord work at its own pace. Never press the cord into the area to be cut.



- The cord can easily remove grass and weeds up against walls, fences, trees and borders. However it can also damage sensitive bark on trees and bushes, and damage fence posts.
- Reduce the risk of damaging plants by shortening the cord to 10-12 cm and reducing the engine speed.

# WORKING TECHNIQUES

## Clearing

- The clearing technique removes all unwanted vegetation. Keep the trimmer head just above the ground and tilt it. Let the end of the cord strike the ground around trees, posts, statues and the like. **CAUTION!** This technique increases the wear on the cord.



- The cord wears quicker and must be fed forward more often when working against stones, brick, concrete, metal fences, etc., than when coming into contact with trees and wooden fences.
- When trimming and clearing, you should use less than full throttle (80%) so that the cord lasts longer and to reduce the wear on the trimmer head.

## Cutting

- The trimmer is ideal for cutting grass that is difficult to reach using a normal lawn mower. Keep the cord parallel to the ground when cutting. Avoid pressing the trimmer head against the ground as this can ruin the lawn and damage the tool.

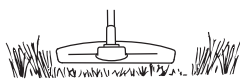

- Do not allow the trimmer head to constantly come into contact with the ground during normal cutting. Constant contact of this type can cause damage and wear to the trimmer head.

## Sweeping

- The fan effect of the rotating cord can be used for quick and easy clearing up. Hold the cord parallel to and above the area to be swept and move the tool side to side.

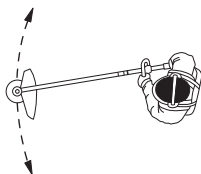

- When cutting and sweeping you should use full throttle to obtain the best results.

# MAINTENANCE

## Inspection and maintenance

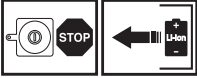

**WARNING!** Always remove the battery before any maintenance on the machine.

**IMPORTANT!** Never clean the battery or the battery charger with water. Strong cleaning agents can damage the plastic.

All servicing and repair work on the machine requires special training. This is especially true of the machine's safety equipment. If your machine fails any of the checks described below you must contact your service agent. When you buy any of our products we guarantee the availability of professional repairs and service. If the retailer who sells your machine is not a servicing dealer, ask him for the address of your nearest service agent. Only use original spare parts.

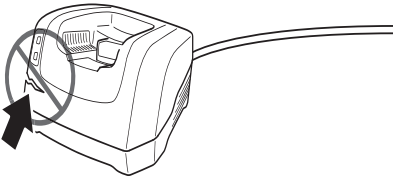

Regularly check that the battery charger and the battery are intact.

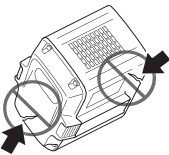

## Cleaning

Clean the machine after use. Make sure the battery and battery charger are clean and that the terminals on the battery and the battery charger are always clean and dry before the battery is placed in the battery charger.

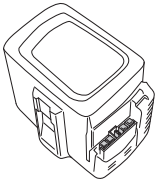

Keep the battery guide tracks clean. Clean plastic parts with a clean and dry cloth.

## Trimmer line

Check the line by threading it into the hole on the cover, as shown in the illustration.

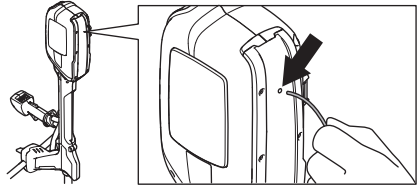

Only use the recommended trimmer heads and trimmer lines. These have been tested by the manufacturer to suit a particular motor size. This is especially important when a fully automatic trimmer head is used. Only use the recommended cutting attachment. See the chapter on Technical data.

## Trimmer head

Check that the trimmer head is undamaged and not cracked. Replace the trimmer head if necessary.

- Press the snap-in clips on the trimmer head and remove the trimmer head and line.

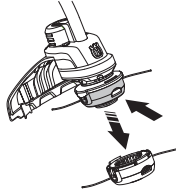

- Pull out the line chute assembly.

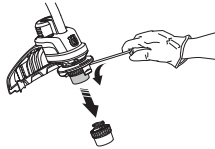

- Remove the nut holding the trimmer head and the drive disc.

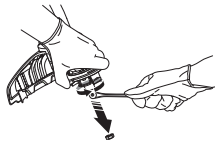

- Replace the trimmer head.
- Install the drive disc and the trimmer head.
- Fit the nut and the line chute assembly.
- Fit the trimmer head.

# MAINTENANCE

## Troubleshooting schedule

Troubleshooting takes place from the keypad.

### Keypad

Control panel	Possible faults	Possible action
Error LED flashes.	The power trigger and the activate button are pressed at the same time.	Release the power trigger and the machine is active.
	Overload.	The trimmerhead is jammed.
		Remove the battery from the machine. Release the trimmer head from grass.
Temperature deviation	Allow the machine to cool down.	
The machine does not run	Dirt in battery connectors.	Clean with compressed air or a soft brush.
Error LED is lit with red light.	Service	Contact your service agent.

Troubleshooting the battery and/or the battery charger during charging.

### Battery

LED display	Possible faults	Possible action
Error LED flashing	The battery is discharged.	Charge the battery
	Temperature deviation	Use the battery in surroundings where temperatures are between -10 °C and 40 °C.
	Over voltage	Check that the mains voltage corresponds with that stated on the rating plate on the machine.
Remove the battery from the battery charger.		
Error LED is lit	Cell difference too much (1V)	Contact your service agent.

### Battery charger

LED display	Possible faults	Possible action
Error LED flashing	Temperature deviation	Use the battery charger only when the surrounding temperature is between 5 °C and 40 °C.
Error LED is lit		Contact your service agent.

# MAINTENANCE

## Maintenance schedule

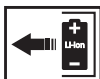

The following is a list of the maintenance steps that must be performed on the machine. Most of the items are described in the Maintenance section. The user must only carry out the maintenance and service work described in this Operator's Manual. More extensive work must be carried out by an authorized service workshop.

Maintenance	Daily maintenance	Weekly maintenance	Monthly maintenance
Clean the outside of the machine with a clean and dry cloth. Never use water.	X		
Keep handles dry, clean and free from oil and grease.	X		
Make sure that the activate and deactivate button works correctly and is not damaged.	X		
Make sure that the power trigger lock and the power trigger function works correctly from a safety point of view.	X		
Check that all controls are undamaged and in working order.	X		
Check that the guard is undamaged and not cracked. Replace the guard if it has been exposed to impact or is cracked.	X		
Check that the trimmer head is undamaged and not cracked. Replace the trimmer head if necessary.	X		
Check that nuts and screws are tight.	X		
Check that the battery is intact.	X		
Check the battery's charge.	X		
Check that the battery charger is intact and functional.	X		
Check the connections between the battery and the machine and also check the connection between battery and the battery charger.			X

# TECHNICAL DATA

## Technical data

136 LiC

### Motor

Motor type	PMDC (4-brush)
Speed of output shaft, rpm	5,800
Cutting width, mm	330

### Weight

Weight without battery, kg	3,1
Weight with battery, kg	4,3

### Battery runtime

Battery runtime, min, (free run) with SavE activated	35
--	----

### Noise emissions

(see note 1)

Sound power level, measured dB (A)	88
Sound power level, guaranteed $L_{WA}$ dB (A)	93

### Noise levels

(see note 2)

Sound pressure level at the operator's ear, measured according to EN ISO 11806 and ISO 22868, dB (A), min./max.:	76
--	----

### Vibration levels

(see note 3)

Vibration levels ( $a_h$ ) at handles, measured according to EN 11806 and ISO 22867,  $m/s^2$ .

Equipped with trimmer head (original), left/right	1,9/1,3
---	---------

Use only a Husqvarna original BLi battery in your machine.

Approved chargers for the specified batteries, BLi.		
Battery charger	QC120	QC330
Mains Voltage, V	220-240	100-240
Frequency, Hz	50-60	50-60
Power,W	125	330

Note 1: Noise emissions in the environment measured as sound power ( $L_{WA}$ ) in conformity with EC directive 2000/14/EC. The difference between guaranteed and measured sound power is that the guaranteed sound power also includes dispersion in the measurement result and the variations between different machines of the same model according to Directive 2000/14/EC.

Note 2: Reported data for equivalent sound pressure level for the machine has a typical statistical dispersion (standard deviation) of 1 dB (A).

Note 3: Reported data for equivalent vibration level has a typical statistical dispersion (standard deviation) of 1  $m/s^2$ .

Approved accessories	Type	Cutting attachment guard, Art. no.
Trimmer head	T25B (Ø 2.0 mm line)	577 96 51-01

---

## TECHNICAL DATA

---

### EC Declaration of Conformity (Applies to Europe only)

We, **Husqvarna AB**, SE-561 82 Huskvarna, Sweden, tel: +46-36-146500, declare that the lawn trimmer **Husqvarna 136 LiC** with serial numbers dating from 2012 onwards (the year is clearly stated on the rating plate, followed by the serial number), comply with the requirements of the COUNCIL'S DIRECTIVE:

- of May 17, 2006 "relating to machinery" **2006/42/EC**.
- of December 15, 2004 "relating to electromagnetic compatibility" **2004/108/EC**.
- of May 8, 2000 "relating to the noise emissions in the environment" **2000/14/EC**.
- of December 12, 2006 "relating to electrical equipment designed for use within certain voltage limits" **2006/95/EC**.
- of September 6, 2006 "on batteries and accumulators and waste batteries and accumulators" **2006/66/EC**.

Notified body 0404, SMP Svensk Maskinprovning AB, Box 7035, SE-750 07 Uppsala, Sweden, has performed conformity assessment according to Annex VI of Directive 2000/14/EC and issued a certificate with the number: **01/1610/001**

VDE-Prüf- und Zertifizierungsinstitut GmbH, Meriansstrasse 28, DE-63069 Offenbach (Am Main), Germany, has performed voluntary type examination on behalf of Husqvarna AB.

For information relating to noise emissions, see the Technical data chapter.

The following standards have been applied:

**EN 60335-1, IEC 60335-2-91, EN 62133, EN 60335-2-29, EN ISO 11806**

Huskvarna January 10, 2012



Peter Lameli, CTO (Authorized representative for Husqvarna AB and responsible for technical documentation.)



# T25B



1

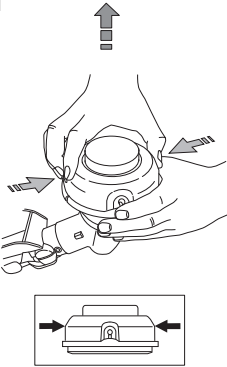

2

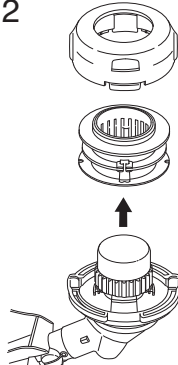

3

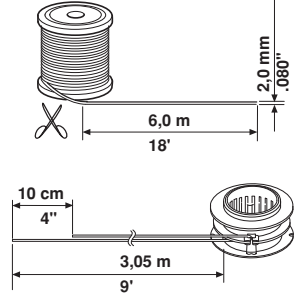

4

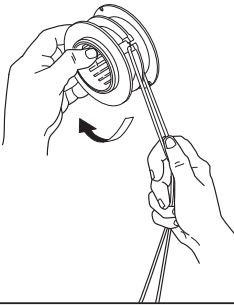

5

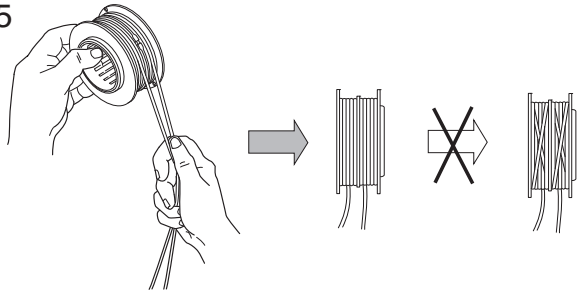

6

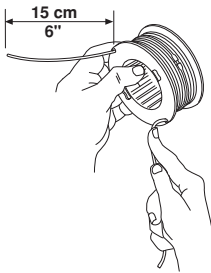

7

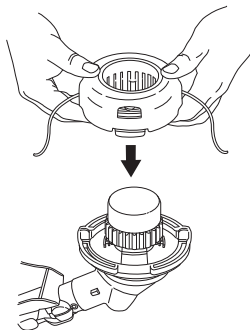

8

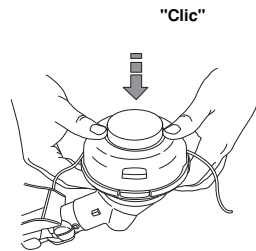

9

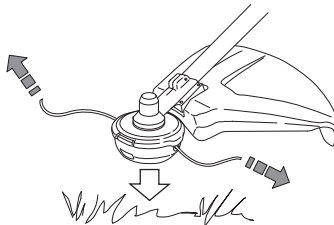





1156475-26



2014-01-27