

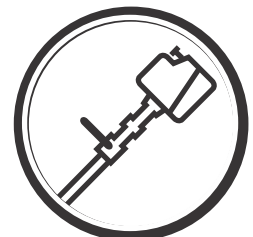



**Instruction Manual**  
**532RBS 542RBS**



**English**

## SAFETY COMES FIRST

Instructions that are marked with the  symbol, as warnings within this manual, relate to issues of vital importance that must be taken into account to prevent serious bodily injury. Thus, you are asked to carefully read all such instructions and to adhere to them without exception.

### ■ NOTES ON THE TYPES OF WARNINGS IN THE MANUAL

#### WARNING

This symbol indicates that instructions must be followed to prevent accidents that could cause serious bodily injury or even death.

#### IMPORTANT

This symbol indicates that instructions must be followed to prevent mechanical failures, breakdowns or damage.

#### NOTE

This symbol indicates suggestions or useful directions for the use of this product.

## **Contents**

---

1. Key to symbols.....	3
2. Symbols on the machine.....	4
3. Specifications.....	4
4. Safety Precautions.....	5
5. Assembly .....	9
6. Fuel.....	12
7. Operation .....	13
8. Maintenance .....	17
9. Troubleshooting .....	21
10. Disposal .....	21

# 1. Key to symbols

## Symbols

WARNING! A clearing saw, brushcutter or trimmer can be dangerous if used incorrectly or carelessly, and can cause serious or fatal injury to the operator or others. It is extremely important that you read and understand the contents of this operator's manual.



Arrows which show limits for handle positioning.



Please read the operator's manual carefully and make sure you understand the instructions before using the machine.



Always wear approved protective gloves.



Always wear:

- Wear a protective helmet where there is a risk of falling objects
- Approved hearing protection
- Approved eye protection



Wear sturdy, non-slip boots.



Max. speed of output shaft, rpm



Watch out for thrown objects and ricochets.



The operator of the machine must ensure, while working, that no persons or animals come closer than 15 meters. Machines fitted with saw blades or grass blades can be thrown violently to the side when the blade comes into contact with a fixed object. This is called blade thrust. The blade is capable of amputating an arm or leg. Always keep people and animals at least 15 meters from the machine.

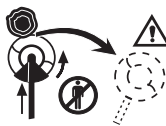

## 2. Symbols on the machine

For safe operation and maintenance, the symbols are engraved in relief on the machine. Follow these directions and be careful not to make any mistakes.



(a) Inlet for the "fuel mix"  
**Location: FUEL TANK CAP**



(b) Position to close the choke  
**Location: COVER OF THE AIR FILTER**



(c) Position to open the choke  
**Location: COVER OF THE AIR FILTER**

## 3. Specifications

Name/Type		HUSQVARNA backpack brushcutter	
		532RBS	542RBS
Type of handle		Loop	
Weight of machine (*1)	kg	8.8	9.0
External dimensions (Length x Width x Height)		mm 315 x 270 x 410	
Outer Tube	mm	Ø26 1500	
Head applied		2-tooth blade (12"), 4-tooth blade, 8-tooth blade, round saw blade (10"), trimmer head	
Power transmission method		Automatic centrifugal clutch, spiral gears	
Gear ratio		1.25 (20:16)	
Direction of blade rotation		Towards the left (from the user's perspective)	
Engine	Type	Single-cylinder air-cooled 2-stroke engine	
	Displacement volume in cc	33.6	41.5
	Capacity of the fuel tank □	1.3	
	Fuel used	Gasoline mixed with lubricating oil	
	Lubricating oil used	2-stroke engine oil	
	Mix ratio	When using genuine Husqvarna oil (FC rated): 50:1 when using other oils on the market (FB rated): 25:1	
	Carburetor	Floating, piston valve	
	Spark production method	CDI	
	Spark Plug	Champion RCJ-6Y	
	Starting mechanism	Recoil starter mechanism	
	Stop method	The primary short circuit on the spark circuit (push button)	

(\*1) without considering the cutting head, shoulder strap and fuel

Bear in mind that due to improvements, detailed product specifications may differ from the information herein presented.

## 4. ▲ Safety Precautions



1. Read this manual carefully until you fully understand its content and adhere to all safety and operating instructions.
2. Keep this manual handy to be able to refer to it at a later stage whenever a doubt arises. Also keep in mind that if you have any questions that cannot be answered here, you can contact the distributor from whom you purchased the product.
3. Always make sure you include this manual when you sell, lend or in any way transfer ownership of the product.
4. Never allow children or others who cannot fully understand the instructions in the manual to use the machine.



### ■ WORKING CONDITIONS

1. When you use the product, you should **wear appropriate clothing and protective equipment**:



- (1) **Helmet**
- (2) **Ear protectors**
- (3) **Protective goggles or face shield**
- (4) **Heavy work gloves**
- (5) **Work boots with non-slip soles**

2. And you must also bring the following:

- (1) Tools included
- (2) Properly stored fuel
- (3) Spare blade
- (4) Elements to mark out your working area (rope, warning signs)
- (5) Whistle (for collaboration or emergencies)
- (6) A small ax or saw (to eliminate obstacles)

3. Do not wear loose clothing, jewelry, shorts, sandals or go barefoot. Do not carry anything that could become caught in any of the unit's moving parts. Do not wear your hair loose below the shoulders.



### ■ WORKING CIRCUMSTANCES

1. Never start the engine in enclosed rooms or buildings. Exhaust gases are dangerous due to their carbon monoxide content.



2. Never use the product:

- (1) When the ground is slippery or if you cannot maintain a steady posture.
- (2) At night, in dense fog, or in other situations when your field of vision may be limited and it is difficult to get a clear view of the work area.
- (3) During heavy rain, thunderstorms, during high winds or at other times when weather conditions may make the use of the product unsafe.



### ■ WORK PLAN

1. You should never use the product under the influence of alcohol, when suffering from exhaustion or a lack of sleep, when you are feeling drowsy as a result of medication to combat colds or at any other time when your judgment may be impaired and you are unable to use the product in a correct and safe manner.
2. When planning your work schedule, leave enough time to rest. Limit the amount of time during which the product is in continuous use to around 30 ~ 40 minutes per session, and take breaks of 10 ~ 20 minutes between work sessions. Also try to limit the total amount of work done in a single day to 2 hours or less.



### ▲ WARNING

1. Failing to consider working time or work methods (**Refer to "PRODUCT USE"**) may give rise to a repetitive strain injury. If you note discomfort, redness, and swelling in the fingers or any other part of the body, consult a physician before it becomes worse.
2. To avoid complaints about noise, in general, use the product between 8 a.m. and 5 p.m. on weekdays and from 9 a.m. to 5 p.m. on weekends.



### NOTE

Review and adhere to local regulations regarding the sound level and operating hours of the product.

## 4. ▲ Safety Precautions

### ■ BEFORE STARTING THE ENGINE

1. The area within a 15 m perimeter of the person using the product should be considered a dangerous area that no one should enter. Where necessary, a yellow warning rope or warning signs should be placed around the perimeter of the area. When the job has to be carried out by two or more people at the same time, care must be taken to constantly look around and to ascertain the location of other people performing the work in order to maintain enough distance between each person to ensure safety.
2. Check the conditions of the work area to prevent accidents as a result of hitting hidden obstructions, such as stumps, stones, cans or broken glass.



### ❗ IMPORTANT

Remove all obstructions before starting work.



3. Inspect the entire unit, searching for loose fasteners and fuel leaks. Make sure that the cutting equipment is correctly installed and securely fastened.
4. Make sure that the cutting equipment guard is in place and firmly attached.
5. Always use the harness. Adjust the harness before starting the engine. The harness must be adjusted so that the left hand can comfortably grip the handle at approximately waist height.



### ■ STARTING THE ENGINE

1. Maintain a distance of at least 15 m between pedestrians and animals and the point of operation. If someone is approaching you, stop the engine immediately.
2. The product is equipped with a centrifugal clutch mechanism, whereby the cutting equipment begins to rotate as soon as the engine starts to run, once the throttle is put into the start position. When starting the engine, place the product on the ground, on a flat, smooth area and hold it firmly in place to ensure that neither the cutting head or the accelerator come into contact with any obstructions once the engine starts.

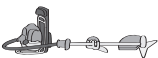
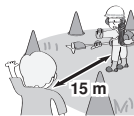

### ▲ WARNING

**Never put the throttle in the high-speed position when starting the engine.**

3. After starting the engine, ensure that the cutting equipment stops rotating when the throttle is fully shut off and returned to its original position. If it continues to revolve even after the throttle has been completely shut off, turn off the engine and take the unit to your HUSQVARNA authorized service workshop for repair.

### ■ PRODUCT USE

#### ❗ IMPORTANT

Only cut material recommended by the manufacturer. Only use the unit for the tasks outlined in the manual.

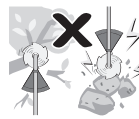

1. Grip the handles firmly with both hands and with the whole hand. Spread your feet slightly (just beyond shoulder width) so that your weight is evenly distributed between both legs and always make sure you maintain a steady and balanced stance while you work.
2. Keep the cutting equipment below waist level.
3. Maintain engine speed at the level required to perform the cutting work and never increase engine speed above the necessary level.
4. If the unit starts to shake or vibrate, shut off the engine and check the entire unit. Do not use the unit until the problem has been properly resolved.
5. Keep all body parts away from the rotary cutting accessory and hot surfaces.
6. Do not touch the muffler, the spark plug or other metal parts of the engine while the engine is running or immediately after the engine is shut off. This could cause serious burns or electrical shock.



## 4. ▲ Safety Precautions

### ■ IF SOMEONE APPROACHES

1. Avoid dangerous situations at all times. Advise adults to keep pets and children away from the area. Be careful if someone is approaching you. The dispersal of waste material can cause injury.
2. If someone calls you or interrupts you in any way while you are working, always ensure that you turn off the engine before turning around.



### ■ MAINTENANCE

1. In order to maintain the product in perfect operating conditions, perform the maintenance and control operations outlined in the manual at regular intervals.
2. Always ensure that you turn off the engine and disconnect the spark plug wire before performing any maintenance or control procedure.

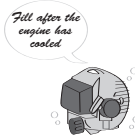

### ▲ WARNING

The metal parts reach high temperatures immediately after stopping the engine.

3. When replacing the cutting equipment or any other part, or when replacing the oil or any lubricant, always ensure you use only HUSQVARNA products or products that are certified by HUSQVARNA for use with **the HUSQVARNA unit**.
4. In the event that you need to replace a part or you have to carry out any maintenance or repair work that is not described in this manual, please contact a representative of the closest HUSQVARNA authorized service workshop to obtain assistance.
5. Use only accessories and attachments produced by HUSQVARNA that are recommended for the unit.
6. Do not disassemble or modify the product in any way or under any circumstances. Otherwise, the product might be damaged during the operation or may no longer operate correctly.

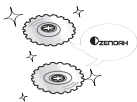

### ■ HANDLING FUEL

1. The engine of the HUSQVARNA product is designed to operate with a mixed fuel, containing gasoline, which is highly flammable. Never store fuel cans or refill the unit's tank in an area with a boiler, stove, wood fire, electrical sparks, welding sparks or any other source of heat or fire that could ignite the fuel.
2. Never smoke while the unit is operating or when filling the fuel tank.
3. When filling the tank, always shut off the engine and allow it to cool down. Look around carefully to ensure that there are no sparks or naked flames nearby before filling the tank.
4. If there is a spillage while filling, thoroughly clean up any spilled fuel with a dry cloth.
5. After refueling, firmly screw on the fuel tank cap and take the unit at least 3 m away from the place where it was filled before starting the engine.

### ■ TRANSPORTATION

1. When transporting the product by carrying it, cover the cutting head if necessary. Lift the product and carry it taking particular care with the blade.
2. Never transport the product over rough terrain for long distances in a vehicle without removing all the fuel in the tank. Otherwise, fuel could leak from the tank during transportation.

### ▲ WARNING

### ■ CONTROLLING BLADE THRUST

Blade thrust can cause serious personal injuries. Therefore, it is important that you read this section carefully. It is vital that you understand what causes blade thrust, how you can reduce the risk of this happening and how you can control the unit where this occurs.

#### 1. What causes blade thrust?

Blade thrust can occur when the rotating blade comes into contact with an object that it cannot cut.

## 4. ▲ *Safety Precautions*

---

Contact with the material causes the blade to stop for an instant and then suddenly start to move or "rebound" against the object that it hit. The operator can lose control of the unit and the blade can cause serious injury to the operator or any person in the vicinity if the blade comes into contact with any part of the body.

### **2. How to reduce the risk of blade thrust:**

- (1) Be aware that blade thrust can occur. Understanding and being aware of the rebound can eliminate the element of surprise.
- (2) Only cut fibrous weeds and grass. Do not allow the blade to come into contact with material that it cannot cut, such as vines and hard woody weeds or rocks, fences, metal, etc.
- (3) Be prepared for blade thrust if you need to cut in an area where you cannot see the blade working, such as areas of dense growth.
- (4) Keep the blade sharp. A blunt blade increases the risk of blade thrust.
- (5) Avoid advancing too quickly with the blade. The blade can rebound against the material it is cutting if the blade is moved forward more quickly than its capacity to cut.
- (6) Only cut from right to left.
- (7) Maintain the route along which you advance free of any material that has been cut and other debris.

### **3. How to maintain better control:**

- (1) Maintain a firm grip on the unit, using both hands. A firm grip can help to prevent the blade rebounding. Keep your left and right hands fully on the respective handles.
- (2) Keep the feet in a comfortable position but prepared for the possibility that the unit could rebound. Do not overreach. Maintain your balance and the position of the feet.



## 5. Assembly

### ▲ WARNING

- Fit each piece correctly. Incorrect assembly could cause an accident.
- If you cannot carry out assembly yourself, consult the distributor from whom you purchased this product.

#### ■ ATTACHING THE SHOULDER STRAP (SE1)

1. Put the ring of the shoulder strap into the hook (A) and firmly secure with the bolt.
2. Attach the hook (B) of each shoulder strap to the D-rings on the frame.

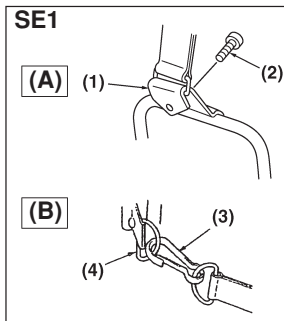

- (A) UPPER END**  
**(B) LOWER END**  
 (1) Hook (A)  
 (2) Bolt (M5x12)  
 (3) Hook (B)  
 (4) D-ring

#### ■ ATTACHING THE SHAFT SHEATH

1. Remove the bolt on the coupling of the outer tube. (SE2)
2. Align the slot of the shaft sheath with the threaded hole and firmly secure with a screw. (SE2)

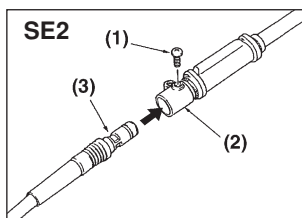

- (1) Bolt  
 (2) Coupling  
 (3) Slot

3. While turning the flexible shaft located at the opposite end to the sheath, insert the flexible shaft into the coupling until it is securely connected (note that it is normal that the flexible shaft does not protrude beyond the sheath at this stage). (SE3)

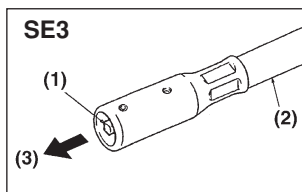

- (1) Flexible shaft  
 (2) Sheath  
 (3) Clutch Housing

4. To connect the clutch housing to the sheath, lay out the sheath in a straight line, align the flexible shaft with the angular hole in the side of the clutch drum and insert the sheath into the clutch housing, ensuring that the hole at the end of the sheath is

facing directly upwards. When you have reached a point just below the catch, you will hear a "click" as the catch in the hole secures the sheath in place. (SE4)

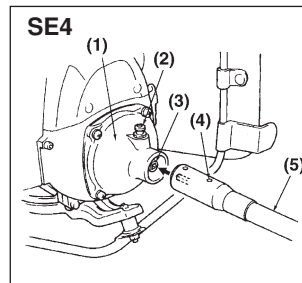

- (1) Clutch Housing  
 (2) Stop  
 (3) Angular hole  
 (4) Hole  
 (5) Sheath

- If you experience any difficulties when inserting the sheath, pull the sheath, rotate the flexible shaft slightly and try to insert it again.
- Once the sheath has been inserted, pull the sheath to make sure the catch is correctly in place.

### ● IMPORTANT

After connecting the inner shaft to the shaft of the main tube, try to pull out the flexible shaft by hand to ensure that it does not come out.

#### ■ CONNECTING THE THROTTLE CABLE

### ▲ WARNING

After connecting the cable, ensure that the cable sleeve is correctly connected to the cable stop. It is dangerous for the cable sleeve to be out of the cable stop as engine speed will not be reduced when you release the throttle lever.

- Line up the throttle cable next to the sheath and secure with tape. (SE5)

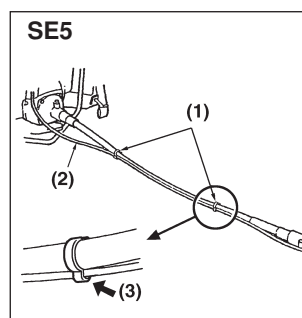

- (1) Tape  
 (2) Throttle Cable  
 (3) Fasten loosely

1. The lever assembly is divided into upper and lower components which are initially held in place by a screw. Use the screwdriver provided with your brushcutter to loosen the screw and remove the lower component and pass the throttle cable running from the engine through the hole in the grip. Once this has been done, insert the end into the hole in the trigger of the lever as shown in the accompanying diagram.

## 5. Assembly

- Align the upper and lower components of the lever back together again and screw the lever into the outer pipe to fix it into place. At this time, be sure to attach the lever so that the projection on the lower part of the lever fits into the cable hold of the grip and leave a gap of 0-5 millimeters when fixing into place

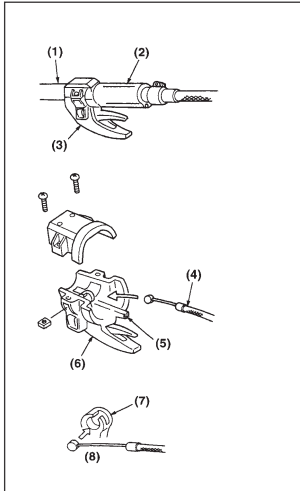

- Outer pipe
- Grip
- Lever assembly
- Throttle cable
- Projection
- Lever assembly (lower component)
- Hole in the trigger
- View of inside lever

### ■ ADJUSTING THE THROTTLE CABLE

- The throttle cable should have a slack of 1-2 mm. Place the throttle lever on the lowest speed setting (that is, fully released). Pull the throttle cable lightly with your fingers to check the slack. Readjust the position of the cable adjuster if there is too much or too little slack. In order to readjust, loosen the locknut. Turn the cable adjuster clockwise to increase the slack or anticlockwise to reduce slack. Lock the cable adjuster with the locknut once you have finished readjusting. (SE7)

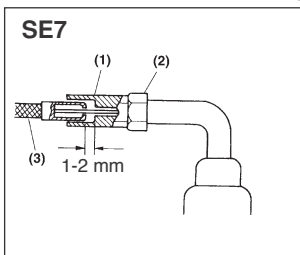

- Cable adjuster
- Locknut
- Throttle Cable

### ■ ATTACHING THE HANDLE

#### NOTE

Attach the loop handle as shown in the accompanying diagram. Note that it is recommended that you attach the handle so that the handle is located some 30-40 cm away from the front end of the right-hand grip.

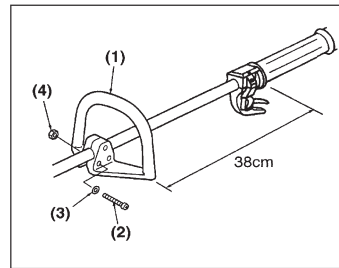

- Loop handle
- Screw
- Washer
- Nut

#### ▲ WARNING

Stop tightening the screws when space A is reduced to zero.

### ■ ATTACHING THE DEBRIS GUARD

#### ▲ WARNING

Never use the machine without the debris guard.

Attach the guard to the clamp on the outer pipe just touching the gearcase. Fix it with 2 bolts.

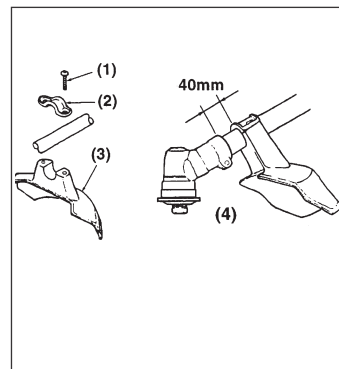

- Bolt (M5\*25)
- Clamp
- Debris guard
- Place to be attach

### ■ BLADE

#### ▲ WARNING

- Do not install or remove the blade while the engine is running.
- Use metal blades and accessories produced by HUSQVARNA when installing the blade.
- When you install or remove the blade, firmly secure the machine and use heavy gloves.
- The blade rotates anticlockwise (viewed from the gearbox). When using an inside-out blade, ensure that it will move in the right direction prior to installation. In particular, if you install a disk saw in the wrong direction, the teeth could break off and be thrown about.

- Loosen the bolt, remove flange A and flange B on the gearbox. (SE10)

(Note that this screw tightens anticlockwise).

## 5. Assembly

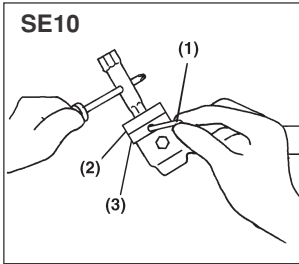

- (1) Rod
- (2) Flange B
- (3) Flange A

2. Fit the cover (SE11, (11)) and secure with a screw.
3. Insert the blade between cutting flange A and cutting flange B. (SE11)
4. Attach the cover and the lock washer. (SE11)
5. Screw in the bolt to secure them in place. (SE11)

**Torque:**  
**14.7~19.6 N·m**  
**(150~200 kgf·m)**

2. Attach the cover and fix it with 3 screws
3. insert blades between cutter holder A and cutter holder B
4. Attach cover and spring washer
5. Screw the nut to fix them into place

**Tighten torque:**  
**14.7~16.6 N·m**  
**(150~200kgf·m)**

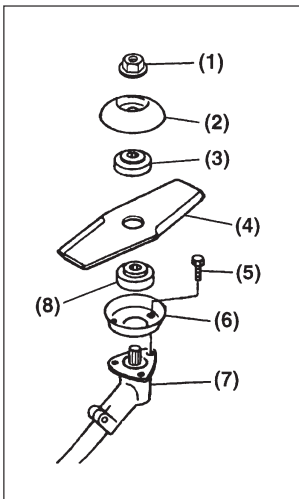

1. Nut
2. Cover
3. Holder (B)
4. Blade
5. Screw
6. Cover preventing grass from getting caught up
7. Gear case
8. Holder(A)

### IMPORTANT

Look at the blade from above and ensure it has been fitted to move in the correct direction.

(SE12)

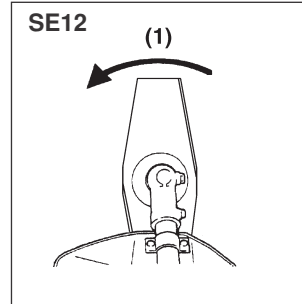

- (1) Direction of rotation

### TRIMMER HEAD (SE11) (SE13)

### IMPORTANT

Given that the resistance of the nylon cutter is higher than that of the metal cutter, a malfunction of the nylon cutter will make the clutch overheat, warp and suffer damage. When using the nylon cutter, pay attention to the following.

- Use genuine HUSQVARNA nylon cutter. If you use other commercially available nylon cutters, make sure that the external length does not exceed 10 cm.
  - Make sure that length of the nylon cable is 17 cm or less.
  - Keep the engine running at a high speed while working.
6. Remove the bolt (1), the lock washer (2), the washer (3), the bolt cover (4) and the cap (11).
  7. Place flange B (5) on top of flange A (9). Screw the shaft bolt (12) into flange B (5).
  8. Then fasten the cutter head to the gear shaft, resting on the flanges. Tighten securely.

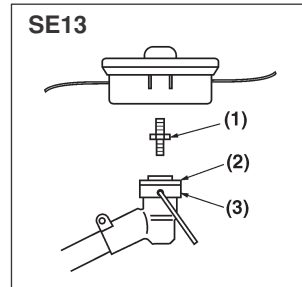

- (1) Shaft bolt
- (2) Flange B
- (3) Flange A

## 6. Fuel



### ▲ WARNING

- Gasoline is highly flammable. Do not smoke or allow flames or sparks to come close to the fuel.
- Clean all the spilled fuel before starting the engine.
- Be sure to stop the engine and allow it to cool before refueling the unit.
- Keep naked flames away from the area where the fuel is handled or stored.

### ❗ IMPORTANT

- Never use oil for 4-stroke engines or water-cooled 2-stroke engines.
- Never use "FUEL WITHOUT OIL (PURE GASOLINE)."
- Never use fuel mixed with water.
- Mixed fuels that have not been used for a month or more may obstruct the carburetor or prevent the engine from functioning correctly. Put the remaining fuel into an airtight container and store in a cool dark room.
- Ask for "mixed gasoline for air-cooled 2-stroke engines" in your nearest gas station, or use fuel made by mixing unleaded gasoline for cars and 2-stroke air-cooled engine oil in a mixing container, following the ratios indicated below, and then shake it to mix well.

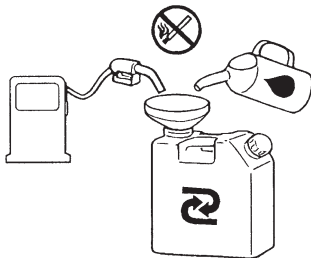

### Mixing ratios:

When using genuine Husqvarna 2-stroke oil (FC rated):

**50:1** (100 ml of oil for every 5 liters of gasoline)

When using other commercially available 2-stroke oil (FB rated):

**25:1** (160 ml of oil for every 4 liters of gasoline)

## 7. Operation

### ■ REFILLING

#### ▲ WARNING

- Fill the fuel tank on a flat surface, outdoors. Do not smoke or allow flames or sparks to come close to the fuel, and put out all cigarettes.
- Before filling the fuel tank while using this machine, ensure that you stop the engine and allow it to cool.
- Ensure that you firmly tighten the cap of the tank.
- Clean up spilled fuel with a dry cloth before starting the engine.

#### 📌 IMPORTANT

Fill the fuel tank to approximately 80% of its capacity. If it is overfilled, fuel might drip from the cap of the tank while the machine is in use.

1. Place the brushcutter you are going to refill on a flat surface, outdoors, and make sure it is stable.
2. Unscrew fuel tank cap a little bit and allow the difference in atmospheric pressure between the inside and outside of the fuel tank to equal out.
3. Remove the cap of the fuel tank and fill it, little by little, to around 80% of its capacity.
4. After refueling, firmly close the cap and make sure that the tank is not leaking fuel.

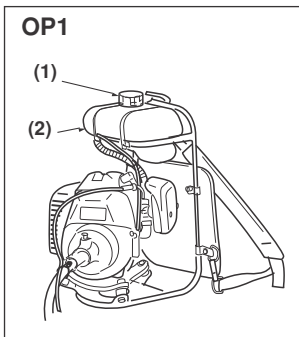

### ■ STARTING THE ENGINE

#### ▲ WARNING

- Before starting the engine after refueling, move the machine at least 3 m away from the place where it was filled.
- Starting the engine where the machine was filled could cause a fire.
- Do not start the engine indoors or in any place that is not well ventilated. This could cause carbon monoxide poisoning that may lead to injuries.

#### ▲ WARNING

- Always hold the throttle lever in the idle position when you start or stop the engine or move the machine. If the throttle lever is placed in any other position, apart from the idle position, the blade will begin to rotate, which is dangerous.
- The engine can be started after a delay. Hold on to the unit until it starts up.

#### ▲ WARNING

- Before starting the engine, check the entire unit in search of problems, such as a loose handle, malfunction of the throttle lever, loose blades and fuel leaks.
- When starting the engine, put the machine on the floor and hold it down firmly. Given that the blade might hit the ground or a nearby object, do not start the engine while holding the machine with a single hand.
- Do not start the engine while holding the throttle lever open as the blade will begin to rotate immediately as soon as the engine starts. When starting the engine, place the machine on to a firm, level surface, and keep any objects away from the blade.
- When starting the engine, keep any objects away from the machine to ensure that the blade does not come into contact with the ground.
- If the blade is still spinning even after the throttle lever has returned to the idle position, stop the engine and check the throttle cable and carburetor idle adjustment screw.
- After starting the engine, make sure that the blade is not moving. If the blade is still moving, stop the engine and check the throttle cable and carburetor idle adjustment screw.
- While using the machine, hold on to each of the handles and keep your eyes on the blade.
- Do not touch the metal section of the engine body and the muffler while using the machine or immediately after use; otherwise, you could be burned.
- Do not touch the spark plug or the connection wire while using the machine, otherwise you could receive an electrical shock.

#### 📌 IMPORTANT

If you repeat the operation of starting with the choke closed, the electrode of the spark plug can become damp and the engine may not start. If this happens, open the choke, place the throttle lever in an almost fully open position and pull the starter cord repeatedly, or try the start procedure again after removing the spark plug and drying the electrode.

## 7. Operation

1. Open the fuel tap. (OP2)
2. Move the choke lever to the closed position. (OP2)

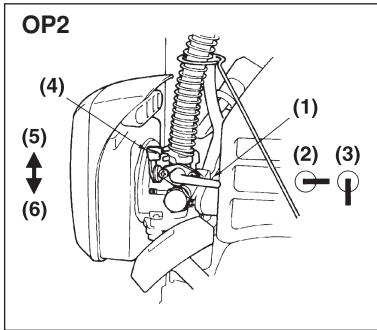

- (1) Fuel tap
- (2) Close
- (3) Open
- (4) Choke lever
- (5) Close
- (6) Open

### NOTE

When re-starting immediately after the engine has stopped, move the choke lever to the open position.

3. Move the throttle lever to the idle position. (OP3)

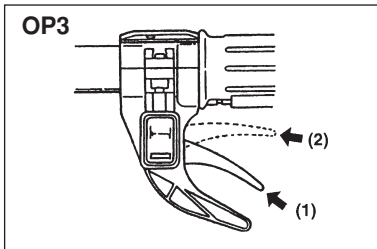

- (1) Idling
- (2) Full throttle

### NOTE

After re-starting immediately after the engine has stopped, move the throttle lever to the idle position.

4. Place the machine on a firm, level surface and ensure that the area surrounding the blade is clear. Then, while holding the main tube with your left hand, put your right foot on the frame and rapidly pull the starter cord with your right hand. (OP4)

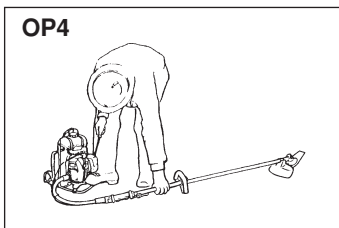

### IMPORTANT

**Do not pull the starter cord until the end, and do not let the handle slip out of your right hand, otherwise it may not return to its original position.**

5. After the engine has started, gradually open the choke.
6. Let the engine run for 2 or 3 minutes to warm up.

### STOPPING THE ENGINE

#### WARNING

- Stop the engine immediately in the event of an emergency.
- Due to inertia, the blade will continue to spin for a while after the engine has stopped. Do not touch the blade until the engine has completely stopped.
- Do not touch the muffler or the spark plug with your bare hands immediately after the engine has stopped. Otherwise, you could be burned because the muffler and the spark plug are very hot.

1. Put the throttle lever back into the idle position.
2. Press the engine stop button. (OP5)
3. Close the fuel tap.

### OP5

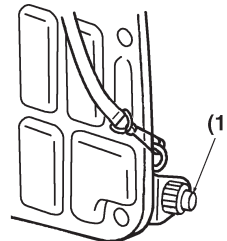

- (1) Engine stop button

### IMPORTANT

If you stop the engine at high revs, you may cause damage to the engine. Return the throttle lever to its original position and reduce engine speed before stopping the engine, except in the event of an emergency.

### USING THE SHOULDER STRAP (OP6)

1. Hold the main tube with your right hand. Place the left strap on to your left shoulder.
2. Change hands and hold the main tube with your left hand. Place the right strap on to your right shoulder.

## 7. Operation

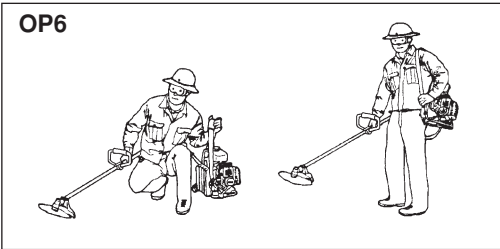

### ■ CUTTING

#### ▲ WARNING

- Always use eye protection, such as safety glasses. Never lean on the rotary cutting head. Stones and other debris could be thrown into the eyes and face and cause serious injury.
- Keep the debris guard in place at all times when using the unit.

#### USE OF THE BLADE (OP7)

1. Always cut guiding the head from right to left.
2. A metal blade cuts best up to the point that is 1/3 of its length from the edge. Use this area to cut bushes and tough, thick weeds. To cut new grass can use up to 2/3 of the blade tip.
3. Adjust the engine speed depending on what you will be cutting. Cut new grass at a medium speed and cut bushes and tough, thick weeds at a high speed.

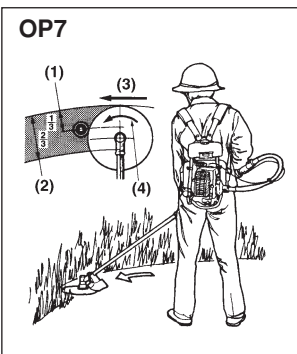

- (1) For branches and trees
- (2) For grass and weeds
- (3) Cutting direction
- (4) Direction of rotation

#### ⓘ IMPORTANT

Operating at low speed means that grass, weeds and branches are more likely to become caught in the blades and also makes the shaft and the clutch wear out more quickly.

#### ▲ WARNING

When you use a metal blade, do not cut grass with the right half of the blade. Otherwise, this may lead to blade thrust, which might cause serious injury.

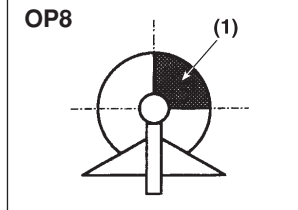

(1) Area of the blade where the machine is prone to blade thrust

#### ▲ WARNING

- When using this machine, please read and adhere to the precautions and instructions outlined under "Safety Precautions" (pages 5 to 8) in this manual.
- Before carrying the main body of the brushcutter on your shoulder, return the throttle lever to the idle position and make sure that the blade has stopped spinning.
- When you carry the main body of the brushcutter on your shoulder, ensure that the accelerator cable does not become tangled and that the blade does not touch the ground.

#### ▲ WARNING

This product employs a flat-type carburetor. If the engine is tilted too much, the fuel in the tank could spill out via the air intake or the carburetor. Do not tilt the engine up or down while cutting, or when storing or transporting the brushcutter.

#### ▲ WARNING

Be careful not to hit the blade against any objects when cutting. Striking the blade against stones, etc., could damage the blade and the drive unit or bend the main tube.

#### USING THE TRIMMER HEAD

- Always remember that the tip of the line performs the cutting. You will get the better results if you do not overload in the cutting area. Allow the unit to cut at its own pace.
1. Hold the unit so that the head is clear of the ground and tilted about 20 degrees towards the direction of the sweep.
  2. To cut, use full throttle.
  3. You can avoid debris being thrown up by sweeping from left to right.

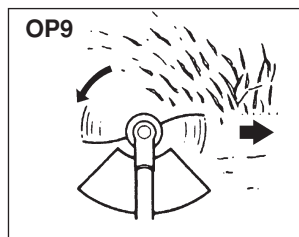

## 7. Operation

---

4. Use a slow deliberate action to cut through dense growth. The speed of the cutting movement will depend on the material you are cutting. Dense growth will require a slower action than light growth.
5. Never use a sweeping motion that is strong enough to put you at risk of losing balance or control of the unit.
6. Try to control the cutting motion with your hips rather of putting the entire workload on to your arm and hands.
7. Take precautions to prevent wire, grass and dead, dry weeds with long roots becoming entangled around the shaft. These materials can clog up the head and cause the clutch to slip, causing damage to the clutch system where this occurs frequently.

### ADJUSTING THE LENGTH OF THE LINE

- The brushcutter is equipped with a semi-automatic nylon-line head that allows the user to feed line without stopping the engine. When the line becomes too short, gently tap the head on the ground while the engine is running at full throttle.
- Each time the head is hit, approximately 2.5 cm (1 in.) of line will be fed through. For a better effect, strike the head against the ground or a hard surface. Avoid tapping against thick, high grass as the engine could stall due to overload.



## 8. Maintenance

### ■ BLADE

- Sharpen all the cutting edges and make sure that the bottom corner is rounded off. (MA1)
- Do not cool the blade with water if you are using a grinder. This could cause cracks in the blade.

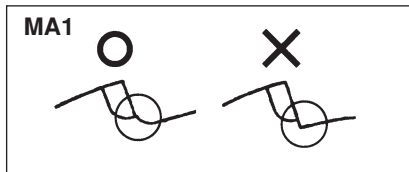

### ■ REPLACING THE CUTTING LINE (MA2)

1. To replace the line, use line with a diameter of 2.4 mm (0.95 in.) The spool can accommodate line of up to 6 m (20 ft) on the 10.16 cm (4 in.) head. Avoid using a longer line as this may reduce cutting performance.

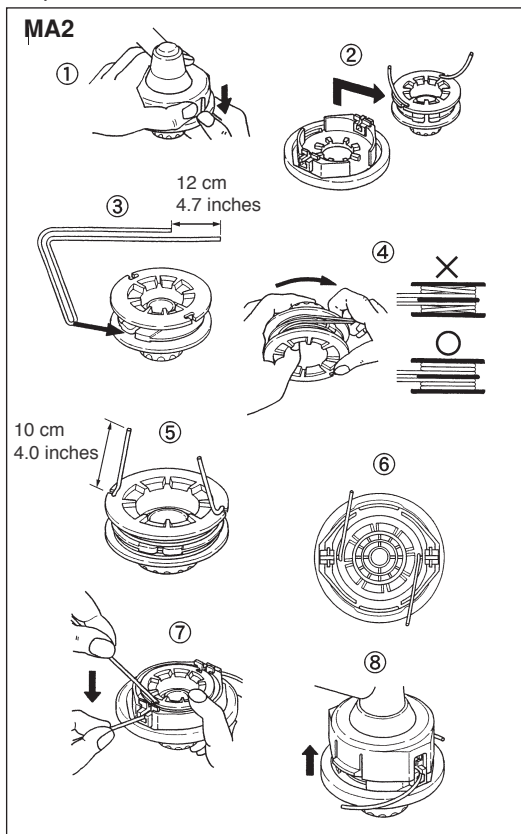

### ▲ WARNING

For safety reasons, do not use line that is reinforced with metal.

2. Press the area with a slot on either end of the spool casing to release the lower cap.
3. Remove the spool and pull out the old line. Fold the new line so that one section is 12 cm (4.7 in.) shorter than the other section. Then hook the folded end on to the slot of the spool.

4. Wind the line in the right direction, as shown on the spool.
5. Hook each end of the line on to the slot on the edge of the spool and then pass the ends through the eyelets in the casing. Make sure that the spring and the washers are in place.
6. While holding the spool against the casing, pull the ends of the line to release them from the slot.
7. Align the slot on the lower cap with the hook on the casing and push cap against the housing until it snaps into place.

### ▲ WARNING

Make sure that the engine has stopped and cooled down before performing any maintenance work on the machine. Contact with a hot head or muffler can cause personal injuries.

### ■ AIR FILTER

Remove the cover of the air filter and clean out the dust inside after every 25 hours of use.

When the filter is very dirty, clean it thoroughly with hot water and mild detergent. Install once it has dried completely.

When the filter is out of shape or damaged, replace it with a new one.

Reference no: Z1418-82130

### ● IMPORTANT

If the air filter becomes obstructed, engine power will be reduced and the fuel consumption will increase.

If you continue to use the machine without an air filter or with a deformed or damaged air filter, the interior of the engine will be subjected to significant wear.

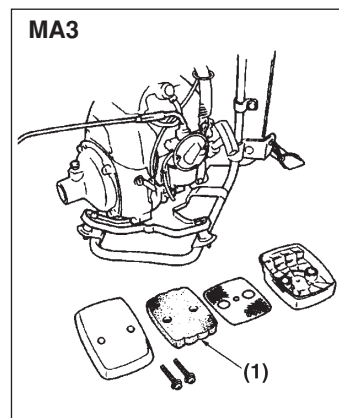

(1) Air filter

## 8. Maintenance

### ■ FUEL FILTER

#### ▲ WARNING

When installing or removing the fuel filter, be careful not to damage the rubber housing. Damaged rubber housing or a poorly fitted fuel filter will cause a fuel leak.

Check the extent to which the fuel filter has become clogged via the fuel inlet on the fuel tank after every 25 hours of use.

If the fuel filter is clogged with dust, drain the fuel tank, remove the fuel filter and clean it with a brush, etc.

If the fuel filter cannot be unclogged or the fuel filter is damaged, replace it with a new one.

Reference no: T1154-85100

#### ● IMPORTANT

When the fuel filter is clogged, the rotational speed of the engine may not increase, or you may experience rotational fluctuations.

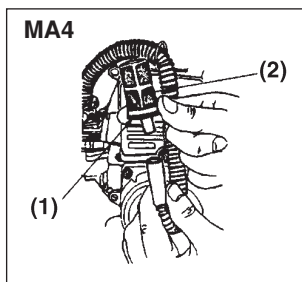

- (1) Rubber housing
- (2) Fuel filter

### ■ SPARK PLUG

#### ▲ WARNING

Do not touch the spark plug with your bare hands immediately after stopping the engine. The spark plug will still be very hot and may cause burns.

Remove the spark plug, check the electrodes and, if they are dirty, clean with a wire brush or a similar tool after every 25 hours of use.

When fitting the spark plug, screw it in with your fingers, then tighten it with the wrench provided as standard accessory.

The distance between the electrodes should be adjusted to between 0.6 and 0.7 mm.

[Torque]  
9.8 to 11.8 N·m  
(100 to 120 kgf·cm)

Designated spark plug  
Champion: RCJ-6Y  
NGK: BPM7A

#### MA5

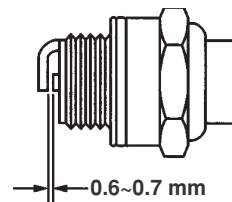

#### ● IMPORTANT

If you use the spark plug wrench to start screwing in the spark plug, the thread may become damaged.

### ■ AIR COOLING

#### ▲ WARNING

Do not allow any debris to cover the air intake while the machine is in operation. It could come into contact with the fan, which is dangerous.

Check the ventilation air cooling intake and the cylinder cooling fin and remove any debris that has accumulated after every 25 hours of use.

#### ● IMPORTANT

If debris or the dirt becomes stuck between the air cooling intake and the cylinder fin, the engine may overheat, which may cause problems.

#### MA6

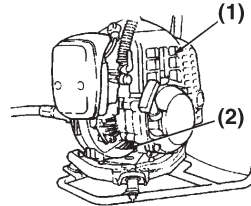

- (1) Cylinder fin
- (2) Air cooling intake

### ■ GEARBOX

Apply lubricating grease to the gearbox after every 25 hours of use.

#### Recommended grease

Heat-resistant lithium based grease (# 2)

#### Gear case

Remove cutter, cutter holder A and plug and insert fresh lubricant

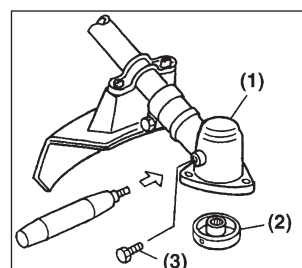

- (1) Gear case
- (2) Holder A
- (3) plug

## 8. Maintenance

### ■ FLEXIBLE SHAFT

Apply grease to the flexible shaft after every 25 hours of use.

1. Remove the flexible shaft as you lift the stopper of the clutch housing.
2. Remove the inner shaft, apply grease to the surface of the inner shaft and insert the inner shaft into the sheath.

### Recommended grease

Heat-resistant lithium based grease (# 2)

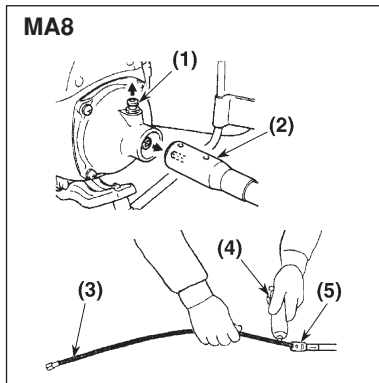

- (1) Stop
- (2) Sheath
- (3) Inner Shaft
- (4) Grease
- (5) Sheath

### ■ MAINTENANCE AFTER EVERY 100 HOURS OF USE

1. Remove the muffler, insert a screwdriver into the ventilation duct and clean off the carbon. Also, clean off any carbon that might be present on the muffler outlet.

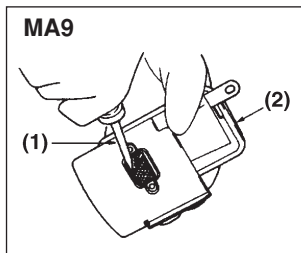

- (1) Screwdriver
- (2) Muffler

2. Firmly tighten all screws, bolts, and connections.
3. Make sure that there is no oil or grease between the clutch housing and the drum. If you find even the smallest quantity, clean it with unleaded gasoline with no oil content.
4. Remove the carburetor float chamber and clean its interior.

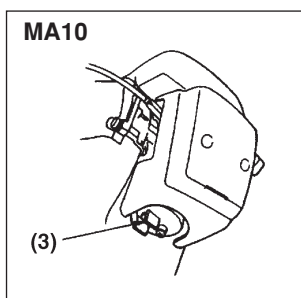

- (1) Float chamber

### ■ ADJUSTING THE ENGINE

#### ▲ WARNING

If the blade continues to spin after the throttle lever has been put into the idle position, this could be dangerous. If the blade is still spinning even after readjusting the idle adjustment screw, the throttle lever, the throttle cable or the clutch could be defective. Please contact the distributor where you purchased this product and ask them to check and repair the problem.

#### ⓘ IMPORTANT

- Engine speed at idle speed is adjusted when the product is supplied from the factory, but you may need to be readjust it in view of changes within the operating conditions (for example, changes in engine stability, air density, etc.). Where readjustment is necessary, try to closely follow the procedure outlined below. If this proves difficult, please contact the distributor where you purchased this product and ask them to carry out the readjustment.
- Make sure that the throttle cable runs parallel to the flexible shaft. If the throttle cable is twisted, straighten it.
- If the flexible shaft is bent, the slack of the throttle cable will change. When you adjust the idle speed, bend the flexible shaft and adjust the idle speed in a vertical position, similar to the position in which you actually use the machine.

#### Adjusting the engine speed at idle

Warm up the engine at a medium speed for a few minutes before starting. Turn the idle adjustment screw on the carburetor body with the screwdriver that is supplied as a standard accessory and adjust the engine speed at idle to an appropriate level (when the throttle lever returns to its original position, the blade does not rotate and the engine does not stop).

## 8. Maintenance

The engine speed increases when the idle adjustment screw is turned clockwise and decreases when it is turned anticlockwise.

**Standard engine speed at idle:  
2,300 to 2,700 rpm**

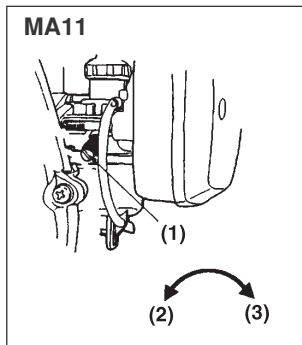

- (1) Idle adjustment screw
- (2) Rotation increases.
- (3) Rotation decreases.

4. Apply a small amount of grease to the gearbox and apply anti-corrosion oil to any metal parts such as the throttle cable.
5. Apply a small amount of oil to the blade, put the cover on the blade and store the machine in a safe place away from heat and moisture.

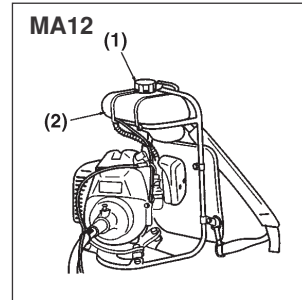

- (1) Fuel tank cap
- (2) Fuel tank

### ■ MAINTENANCE PRIOR TO LONG-TERM STORAGE

#### ▲ WARNING

This machine is highly flammable.

- When you remove fuel, keep the fuel tank well away from flames.
- Be careful not to spill fuel, and clean all the spilled fuel thoroughly.

#### ● IMPORTANT

- If you are not going to use the machine for a long time (two months or more), remove the fuel from the fuel tank and the carburetor. If you leave the fuel tank and the carburetor full of fuel for an extended period of time, the fuel could deteriorate and obstruct the inside of the carburetor, which could cause engine problems (for example, poor start or output).
  - When storing the machine over a long period of time, loosen the fuel tank cap slightly. Excessive tightening of the cap could cause the housing to go out of shape over time.
1. Remove any dirt from the machine with a brush and check the damage and slack of each piece. If you find any defective pieces, repair them to ensure that the machine is fully ready for use on the next occasion.
  2. Remove the fuel from the tank, turn on the engine and let it run until it stops naturally.
  3. Remove the spark plug and pour 1 to 2 ml of 2-stroke engine oil into the engine. Pull the starter cord two or three times, fit the spark plug again and leave the cord in the compressed position.

## 9. Troubleshooting

PROBLEM	MAIN CAUSE	SOLUTION
The engine does not start.	• Poor fuel (different quality, deterioration)	• Replace it with normal fuel (page 12).
	• Excessive fuel suction	• Open the choke, open the throttle fully and pull the cord several times (pages 13,14).
	• Obstruction of the muffler outlet	• Clean the muffler (pages 18,19).
	• Dirt on the spark plug electrodes, a short circuit or a broken cable	• Clean the electrodes or replace the spark plug (page 18☆).
The engine does not accelerate.	• Poor fuel (different quality, deterioration)	• Replace it with normal fuel (page 12).
	• Obstruction of the muffler outlet	• Clean the muffler (page 19).
The engine stalls when the accelerator returns to its initial position.	• The engine speed at idle is too low.	• Readjust the idle adjustment screw (Page 20).
The rotational speed of the engine changes.	• Clogged fuel filter	• Clean or replace the fuel filter (page 18☆).
Abnormal vibrations	• Damaged or deformed blade	• Replace the blade (page 11☆).
Deterioration of fuel consumption	• Clogged air filter	• Clean the air filter (page 17).
	• Blunt blade	• Replace the blade (page 11☆).
	• Poor lubrication of the flexible shaft	• Apply grease (page 19).

- When the symptoms in the left column do not improve once you implement the measures in the right column, please contact the distributor where you purchased this product.
- For the steps marked with ☆, buy genuine HUSQVARNA parts at the store where you purchased this product.

### ▲ WARNING

- **Do not modify or disassemble the machine. The modification or disassembly of the machine may cause damage to it during operation or cause an unexpected incident due to a fuel leakage or a malfunction.**
- **When inspecting or performing maintenance on the machine, keep the machine away from any fire sources (such as a lit cigarette). Otherwise, the fuel may ignite.**
- **Use genuine HUSQVARNA or specialized fasteners (bolts, nuts and screws). Using parts produced by another manufacturer could damage the machine or cause an unexpected incident due to parts falling off while the machine is operating.**

## 10. Disposal

- When you dispose of the machine, do not disassemble it.
- When you dispose of the machine, the fuel or oil, make sure you comply with local regulations.



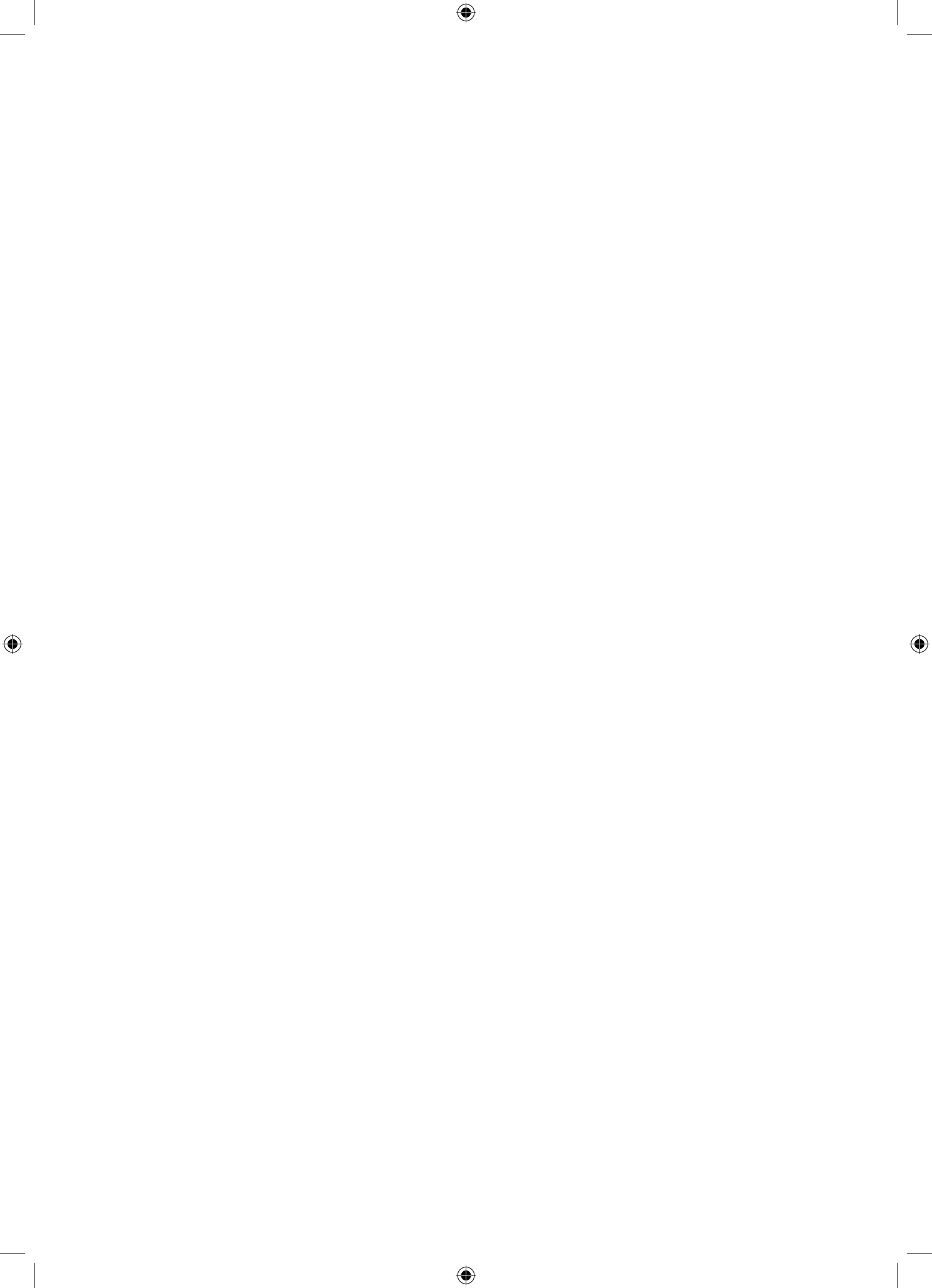



[www.husqvarna.com](http://www.husqvarna.com)

Original Instructions  
1157704-26



2015-09-29