

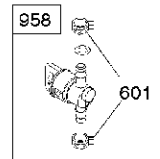

SPARE PARTS LIST

ENGINES & TRANSMISSIONS

BRIGGS & STRATTON ENGINES,
1006070165H8, 2017-01

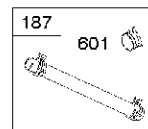
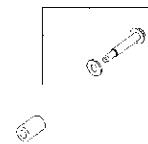
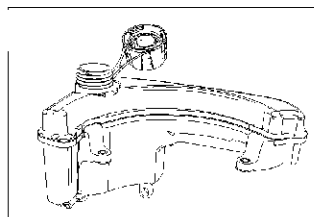
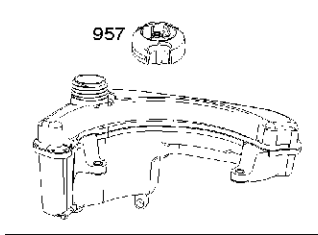
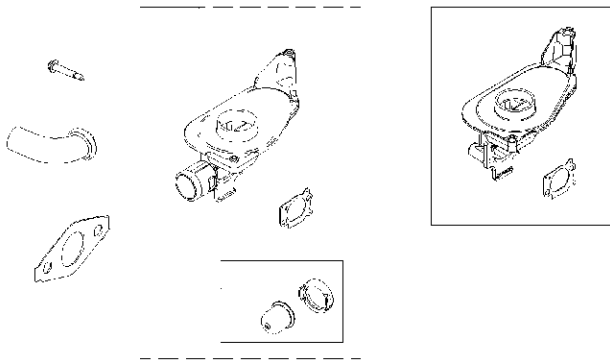
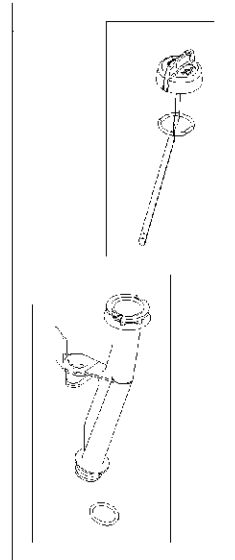
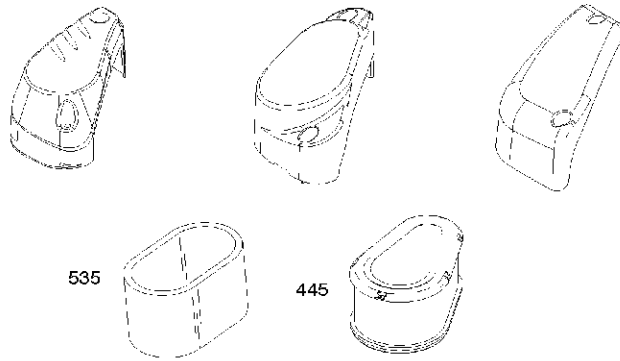

Air filter

BRIGGS & STRATTON ENGINES, 1006070165H8, 2017-01

Ref	Part No	Description	Remark	QTY KIT
187	576 92 09-01	FUEL HOSE	791766	1
445	584 95 83-01	AIR FILTER	792038	1
535	584 95 94-01	PREFILTER	793676	1
601	582 28 77-32	CLAMP	791850	1
957	584 95 80-01	CAP	692046	1
958	584 95 81-01	VALVE	698183	1
N/A	589 66 98-95	SERVICE KIT	Tune up kit, Workshop package, 992234	1

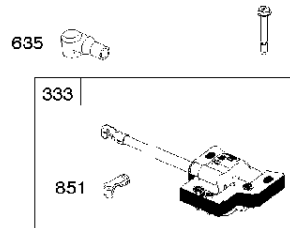
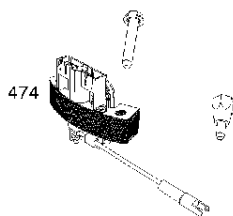
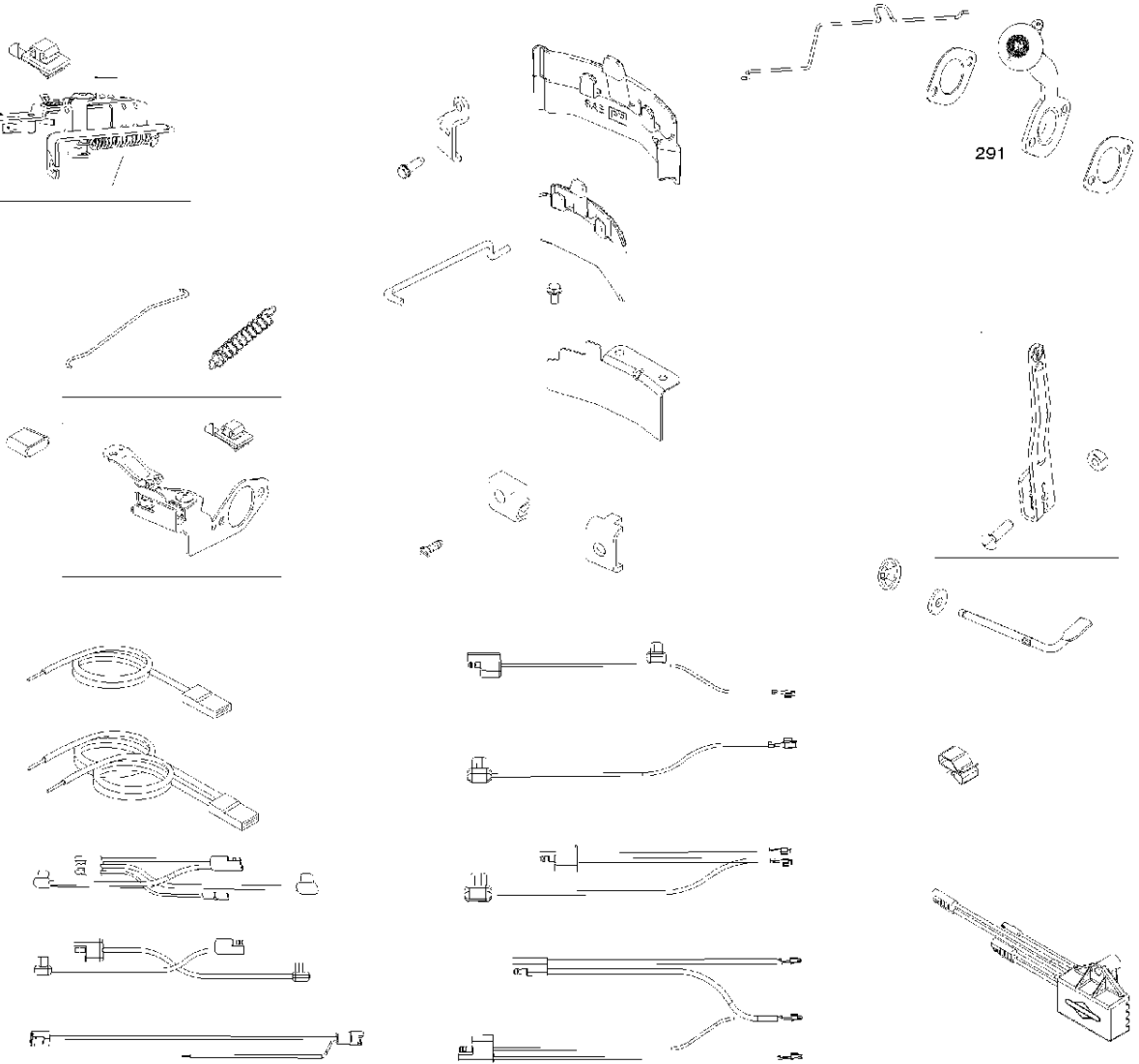
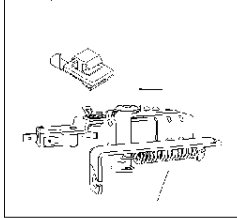

Controls

BRIGGS & STRATTON ENGINES, 1006070165H8, 2017-01

Ref	Part No	Description	Remark	QTY KIT
291	584 95 87-01	THERMOSTAT	793498	1
333	589 66 98-25	ARMATURE	592445	1
474	584 95 95-01	GENERATOR	794103	1
635	582 31 35-85	SPARK PLUG CAP	66538S	1
851	584 96 04-01	SPARK PLUG CAP	493880S	1

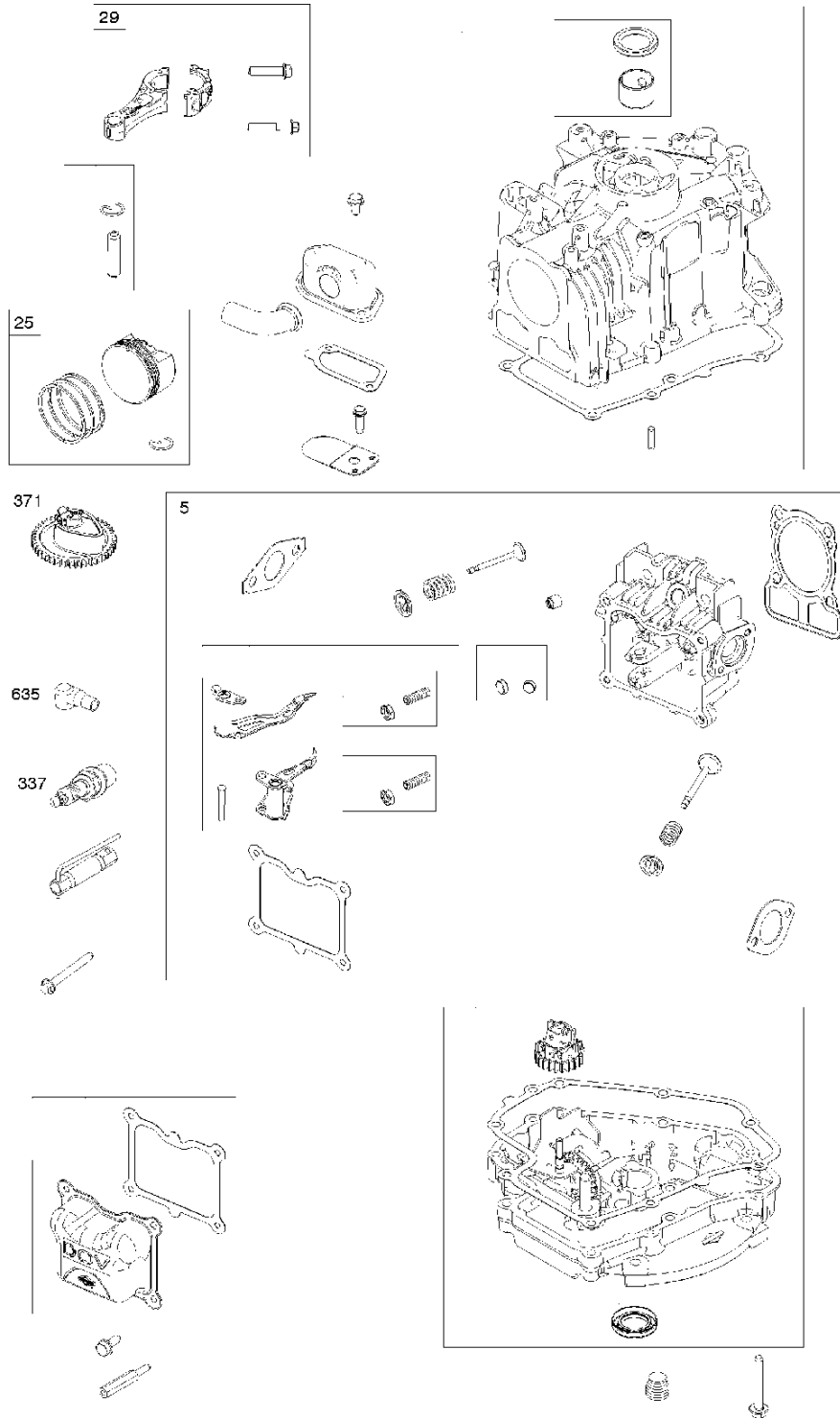

WARNING LABEL

WARNING
 Read and follow Operating Instructions before starting engine.
 Backfire is flammable. Allow engine to cool at least 2 minutes before refueling.
 Engines emit carbon monoxide (CO) and other pollutants in enclosed areas.
 Other areas (as indicated) may exceed OSHA Do not touch hot parts.

REQUIRED when replacing parts with warning labels affixed.

WARNING LABEL

REQUIRED when replacing parts with warning labels affixed.

REPAIR MANUAL

EMISSIONS LABEL

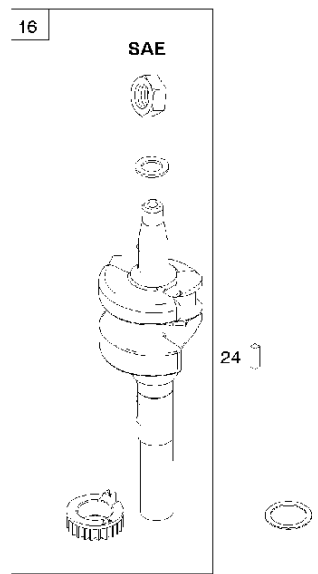

Cylinder

BRIGGS & STRATTON ENGINES, 1006070165H8, 2017-01

Ref	Part No	Description	Remark	QTY KIT
5	589 66 98-26	CYLINDER HEAD	592536	1
16	584 95 91-01	CRANKSHAFT	793616	1
24	582 28 90-90	WOODRUFF KEY	222698S	1
25	582 31 10-82	PISTON	793519	1
29	584 95 89-01	CONNECTING ROD	793510	1
337	582 31 23-65	SPARK PLUG CAP	692720	1
371	584 95 96-01	CAMSHAFT	794574	1
635	582 31 35-85	SPARK PLUG CAP	66538S	1
N/A	589 66 98-12	KEY	Flywheel, Workshop package, 4181	10
N/A	589 66 98-07	KEY	Flywheel, Workshop package, 4144	50

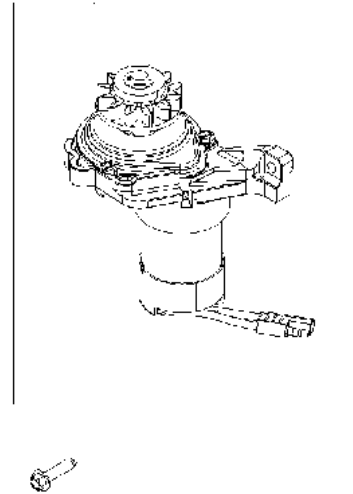
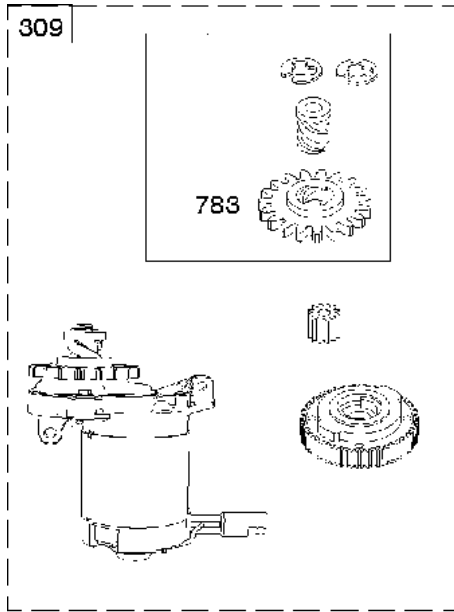

358

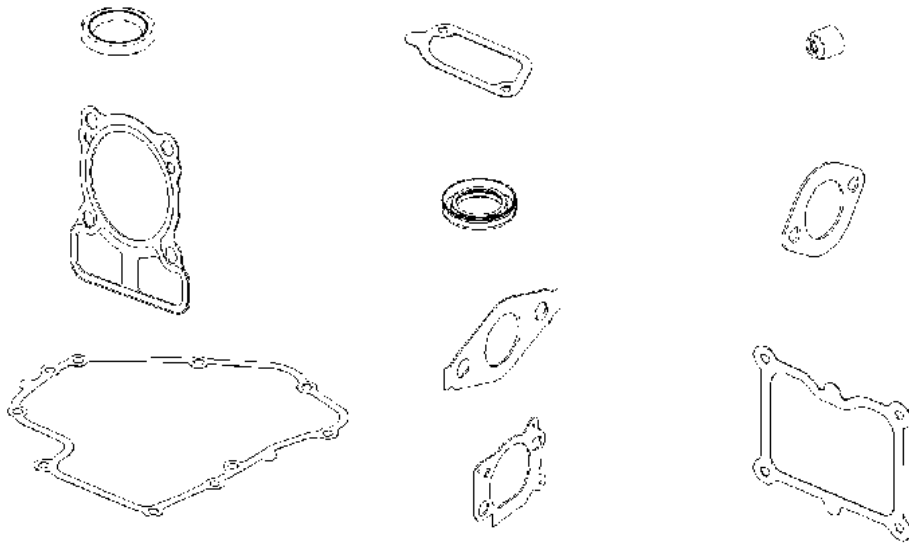

1095



Gasket kit

BRIGGS & STRATTON ENGINES, 1006070165H8, 2017-01

Ref	Part No	Description	Remark	QTY KIT
309	584 95 99-01	ELECTRIC STARTER	796386	1
358	584 95 92-01	GASKET KIT	793623	1
783	584 95 97-01	GEAR	795099	1
1095	584 95 93-01	GASKET KIT	793624	1

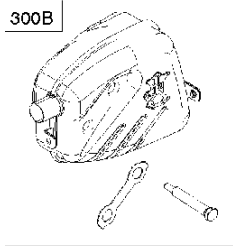
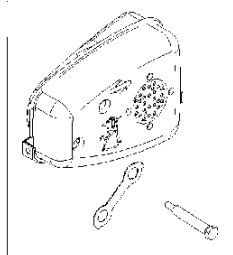
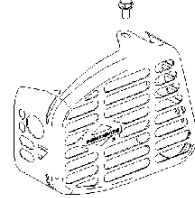
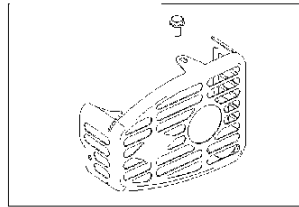
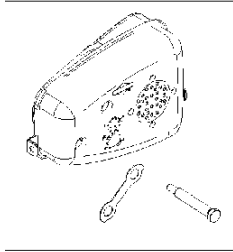

300B

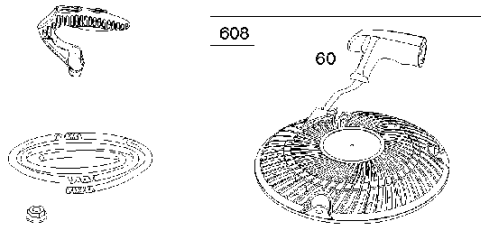

608

60



791

1511

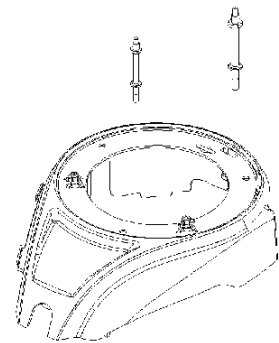
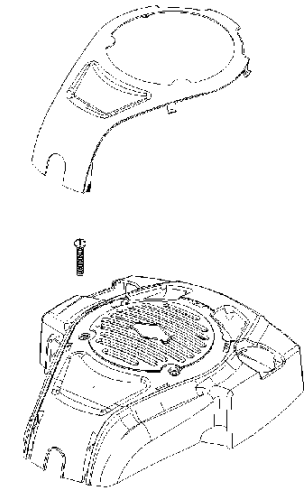
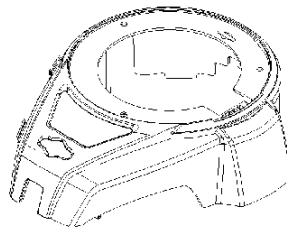
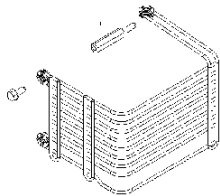

SAE METRIC

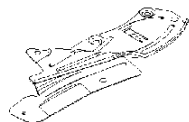

Starter

BRIGGS & STRATTON ENGINES, 1006070165H8, 2017-01

Ref	Part No	Description	Remark	QTY KIT
60	585 39 07-01	HANDLE	281434S	1
300B	589 66 98-72	MUFFLER	793679	1
608	582 31 25-74	STARTER HOUSING	593958	1
791	588 92 98-01	BATTERY CHARGER	593562	1
1511	588 83 61-01	BATTERY	593560	1