

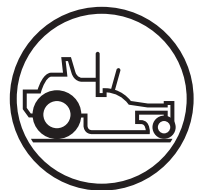

**Husqvarna**<sup>®</sup>



## **Parts Manual**

**Z 548 / 967 669501-00**

Please read the operator manual carefully and make sure you understand the instructions before using the machine.

Gasoline containing a maximum of 10% ethanol (E10) is permitted for use in this machine. The use of gasoline with more than 10% ethanol (E10) will void the product warranty.



When you need spare parts or support in service questions, warranty issues, etc., please consult the following professional:

This manual belongs to the machine with the manufacturing number:	Engine	Transmission

### Manufacturing Number

The machine's manufacturing number can be found on the printed plate affixed to the engine compartment.

Stated on the plate, from the top are:

- The machine's type designation (I.D.).
- The manufacturer's type number (Model).
- The machine's serial number (Serial no.)

*Please have the type designation and serial number available when ordering spare parts.*

# CONTENTS

FRAME.....	4
ENGINE MOUNTING, GUARDS & MUFFLER .....	6
STEERING / BRAKE .....	8
CONTROLS.....	10
FUEL SYSTEM.....	12
HYDRAULIC PUMP-MOTOR.....	14
HYDRAULIC GUARD.....	16
WHEELS & TIRES .....	18
MOWER LIFT / DECK LIFT.....	20
MOWER DECK / CUTTING DECK .....	22
BLADESHAFT ASSEMBLY .....	24
SEAT .....	26
DECALS .....	28

Illustrations may or may not represent the actual assemblies and it is not recommended to use this manual as a guide to assemble or disassemble the mower.

NOTE: All fasteners are Grade 5 unless otherwise specified.

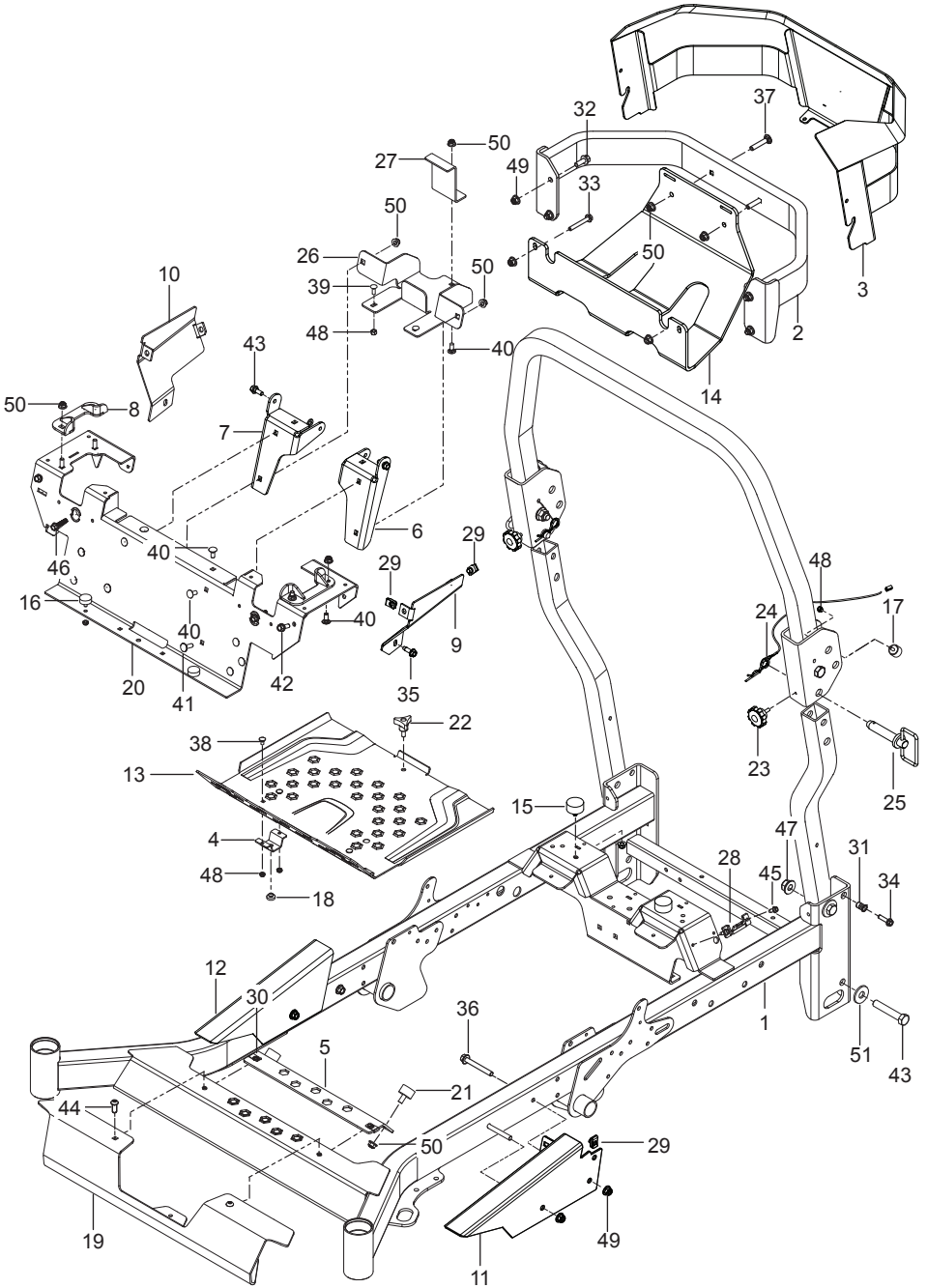

Ref.	Part No.	Qty	Description	Kit / Assy Includes
1	591 35 98-01	1	Frame w/ Safety Decal	
2	522 73 89-02	1	Guard Rear Org	
3	584 85 93-01	1	Guard Engine Grey	
4	589 80 88-02	2	Bracket, Floorpan	
5	589 80 72-02	1	Bracket, Isolator Support Blk	
6	589 44 82-02	1	Bracket, Seat Mount Left	
7	589 44 82-04	1	Bracket, Seat Mount Right	
8	582 48 11-01	2	Bracket, Stop	
9	582 48 10-02	1	Panel, Close Out Left Org	
10	582 48 10-04	1	Panel, Close Out Right Org	
11	582 48 08-03	1	Panel, Wedge Left Org	
12	582 48 08-04	1	Panel, Wedge Right Org	
13	589 30 46-02	1	Plate, Footrest Org	
14	576 70 14-01	1	Plate, Skid Gry	
15	582 47 87-01	2	Bumper 5/16-18	
16	575 81 15-01	2	Bumper 1/4-20 x 3/8" Stud	
17	522 80 14-01	2	Bumper 1/4-20 Male Stud	
18	539 10 25-87	2	Bumper, Grommet	
19	589 74 52-02	1	Cover, Front Plate Gry	
20	582 48 05-02	1	Cross Member, Front Org	
21	589 74 40-01	2	Isolator, Footrest	
22	539 10 44-11	1	Knob w/Stud	
23	591 34 45-01	2	Knob	
24	591 10 17-01	2	Pin w/ Lanyard	
25	591 10 16-01	2	Pin, Handle	
26	582 46 07-02	1	Plate, Battery	
27	582 46 06-02	1	Mount, Battery	
28	589 50 07-01	1	Mount, Fuse Box	
29	539 10 47-63	7	Retainer 5/16-18 U Type	
30	589 80 68-01	2	Retainer 3/8-18 U Type	
31	539 11 10-28	2	Nutsert 5/16-18	
32	525 61 28-01	4	Bolt 3/8-16 x 1 Hex Flange Hd	
33	574 23 38-01	2	Bolt 5/16-18 x 2-1/4 Hex Flange Hd	
34	525 54 40-01	2	Bolt 5/16-18 x 1-1/4 Hex Flange Hd Tap	
35	539 11 32-26	4	Bolt 5/16-18 x 1 Thread Form	
36	577 11 77-01	4	Bolt 3/8-16 x 3 Hex Flange Hd	
37	539 10 01-45	2	Bolt 3/8-16 x 2 Round Hd Square Neck	
38	872 14 04-04	4	Bolt 1/4-20 x 1/2 Round Hd Square Neck	
39	539 11 56-20	2	Bolt 1/4-20 x 3/4 Round Hd Square Neck	
40	539 99 03-16	14	Bolt 5/16-18 x 3/4 Round Hd Square Neck	
41	539 99 02-08	2	Bolt 5/16-18 x 1 Round Hd Square Neck	
42	539 11 03-03	4	Bolt 5/16 Shoulder	
43	580 75 46-01	6	Bolt 5/8-11 x 3-1/2 Hex Hd	
44	589 79 72-01	2	Screw 3/8-16 x 1 Button Hd Torx	
45	817 49 04-08	2	Screw 1/4-20 x 1/2 Thread Roll	
46	585 98 61-01	2	Screw 1-1/4 Shakeproof Black	
47	525 82 91-01	6	Nut 5/8-11 Hex Flange Nyloc	
48	539 97 69-78	6	Nut 1/4-20 Hex Nyloc	
49	521 99 65-01	12	Nut 3/8-16 Hex Flange Nyloc	
50	539 11 28-99	21	Nut 5/16-18 Hex Flange Nyloc	
51	539 10 26-53	4	Washer 5/8 Std Flat	
	NOT SHOWN			
	590 87 78-01	1	ROPS Assy Complete	

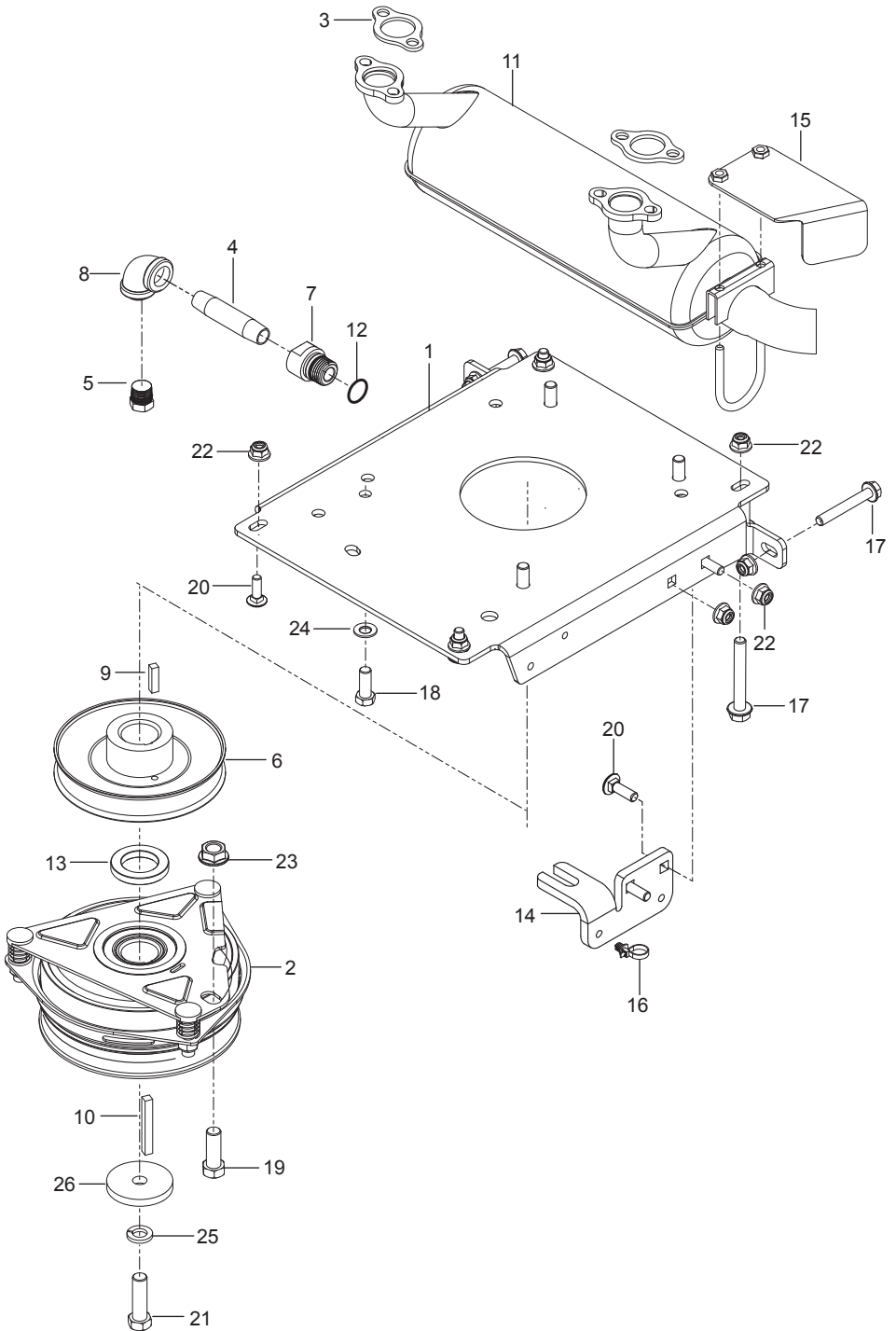

Ref.	Part No.	Qty	Description	Kit / Assy Includes
1	582 73 33-02	1	Plate, Engine	
2	539 11 34-37	1	Clutch	
3	586 83 97-01	2	Gasket, Exhaust	
4	539 11 89-11	1	Pipe 3/8 x 3"	
5	522 83 70-01	1	Plug, Drain, 3/8"	
6	510 01 98-01	1	Pulley, Engine	
7	539 11 96-80	1	Adapter, Oil Drain	
8	539 10 50-72	1	Elbow 3/8" Npt	
9	539 10 53-08	1	Key 1/4 x 1	
10	539 91 02-10	1	Key 1/4 x 2	
11	525 75 02-01	1	Muffler	
12	539 10 96-18	1	O-Ring	
13	525 31 39-01	1	Spacer	
14	522 67 67-02	1	Stop, Clutch	
15	579 15 09-01	1	Shield, Muffler	
16	505 28 00-01	1	Tie Wrap w/Clip	
17	574 23 38-01	4	Bolt 5/16-18 x 2-1/4 Hex Flange Head	
18	539 99 05-63	4	Bolt 3/8-16 x 1 Hex Head	
19	539 10 48-67	1	Bolt 7/16-14 x 1-1/4 Hex Head	
20	539 99 02-08	4	Bolt 5/16-18 x1 Round Head Square Neck	
21	581 33 28-01	1	Bolt 7/16-20 x 1-1/2 Hex Head Clutch	
22	539 11 28-99	8	Nut 5/16-18 Hex Flange Nyloc	
23	539 10 25-82	1	Nut 7/16-14 Hex Whiz Lock	
24	539 10 25-93	4	Washer 3/8 Disc Spring Spec	
25	539 99 02-47	1	Washer 7/16 Slotted Lock Std	
26	539 12 56-26	1	Washer	
	NOT SHOWN			
	-----	1	Engine, Kawasaki FX691V 22 HP For Engine Replacement Parts, See a Kawasaki Dealer	

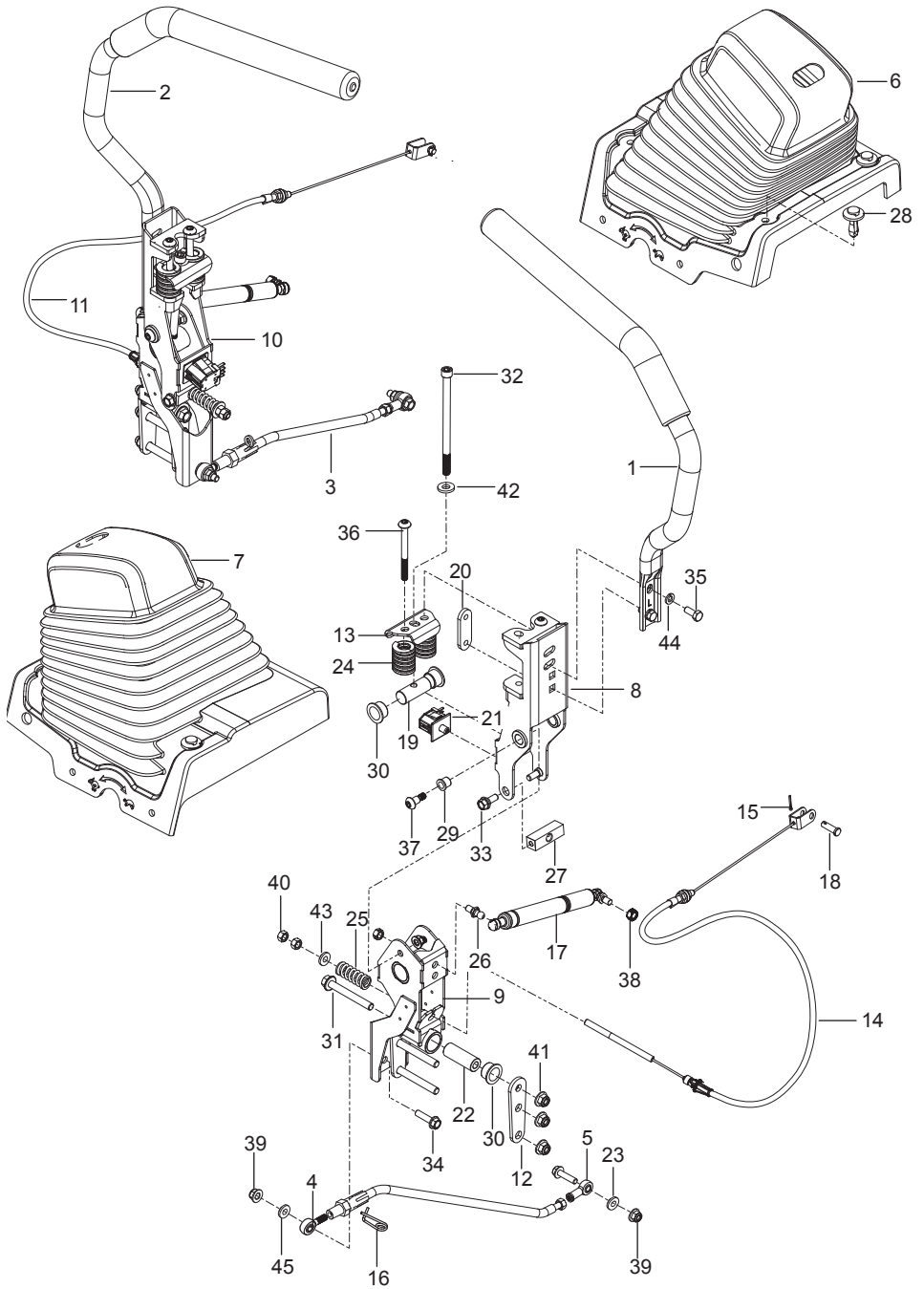



Ref.	Part No.	Qty	Description	Kit / Assy Includes
1	582 47 55-01	1	Lever w/ Grip Left	
2	582 47 55-02	1	Lever w/ Grip Right	
3	501 56 74-01	1	Assembly, Rod Control Left	4, 5, 16, 23
	501 56 75-01	1	Assembly, Rod Control Right	4, 5, 16, 23
4	588 69 25-02	2	End, Rod Male	
5	579 76 46-01	2	End, Rod Female	
6	591 19 33-01	1	Bellow Kit, Control Left	28
7	591 19 33-02	1	Bellow Kit, Control Right	28
8	592 65 38-01	1	Carrier, Upper w/ Bearings Left	29
	592 65 38-02	1	Carrier, Upper w/ Bearings Right	29
9	582 47 58-02	2	Carrier, Lower	30
10	592 27 24-01	1	Assembly, Carrier Left w/ Park Brake	without 3, 17
	592 27 24-02	1	Assembly, Carrier Right w/ Park Brake	without 3, 17
11	592 65 35-01	1	Assembly, Park Brake	14, 15, 18, 25, 36, 43
12	582 47 51-02	4	Bracket, Control	
13	582 47 69-01	2	Bracket, Spring	
14	582 47 75-01	2	Cable, Brake	
15	532 16 94-84	2	Clip	
16	582 55 19-01	2	Clip, Control	
17	588 77 54-01	2	Damper	
18	582 47 74-01	2	Pin, Clevis	
19	589 50 51-01	2	Pivot	
20	589 48 96-01	2	Retainer	
21	589 50 09-01	2	Switch NC	
22	582 47 50-01	2	Spacer, Pivot	
23	582 71 13-03	2	Spacer, Step Up	
24	582 47 70-01	4	Spring 1-1/4 x 5	
25	532 15 13-32	2	Spring, Brake	
26	539 11 06-07	4	Stud 10mm Ball	
27	582 47 72-01	2	Yoke, Brake Cable	
28	582 48 29-01	10	Rivet Pin	
29	582 47 68-01	4	Bearing 1/2 Flange	
30	539 13 15-18	8	Bearing, Flange	
31	577 11 77-01	6	Bolt 3/8-16 x 3 Hex Flange Hd	
32	589 50 56-01	2	Bolt 3/8-16 x 6	
33	539 11 03-03	4	Bolt 5/16 Shoulder	
34	525 54 40-01	4	Bolt 5/16-18 x 1-1/4 Hex Flange Hd	
35	539 97 69-34	4	Bolt 5/16-18 x 3/4 Hex Hd	
36	582 47 71-01	4	Bolt 5/16-18 x 3-1/2 Torx	
37	582 47 64-01	2	Bolt 5/16-18 3/8 x 1/2 Shoulder	
38	539 99 01-84	4	Nut 5/16-18 Hex Center Lock	
39	539 11 28-99	8	Nut 5/16-18 Hex Flange Nyloc	
40	539 99 02-23	4	Nut 5/16-24 Hex	
41	521 99 65-01	6	Nut 3/8-16 Hex Flange Nyloc	
42	522 02 34-01	2	Washer 3/8 Thick	
43	539 99 06-92	2	Washer 5/16 Std Flat	
44	539 99 01-87	4	Washer 5/16 Lock	
45	819 11 11-16	2	Washer 11/32 16 Gauge	

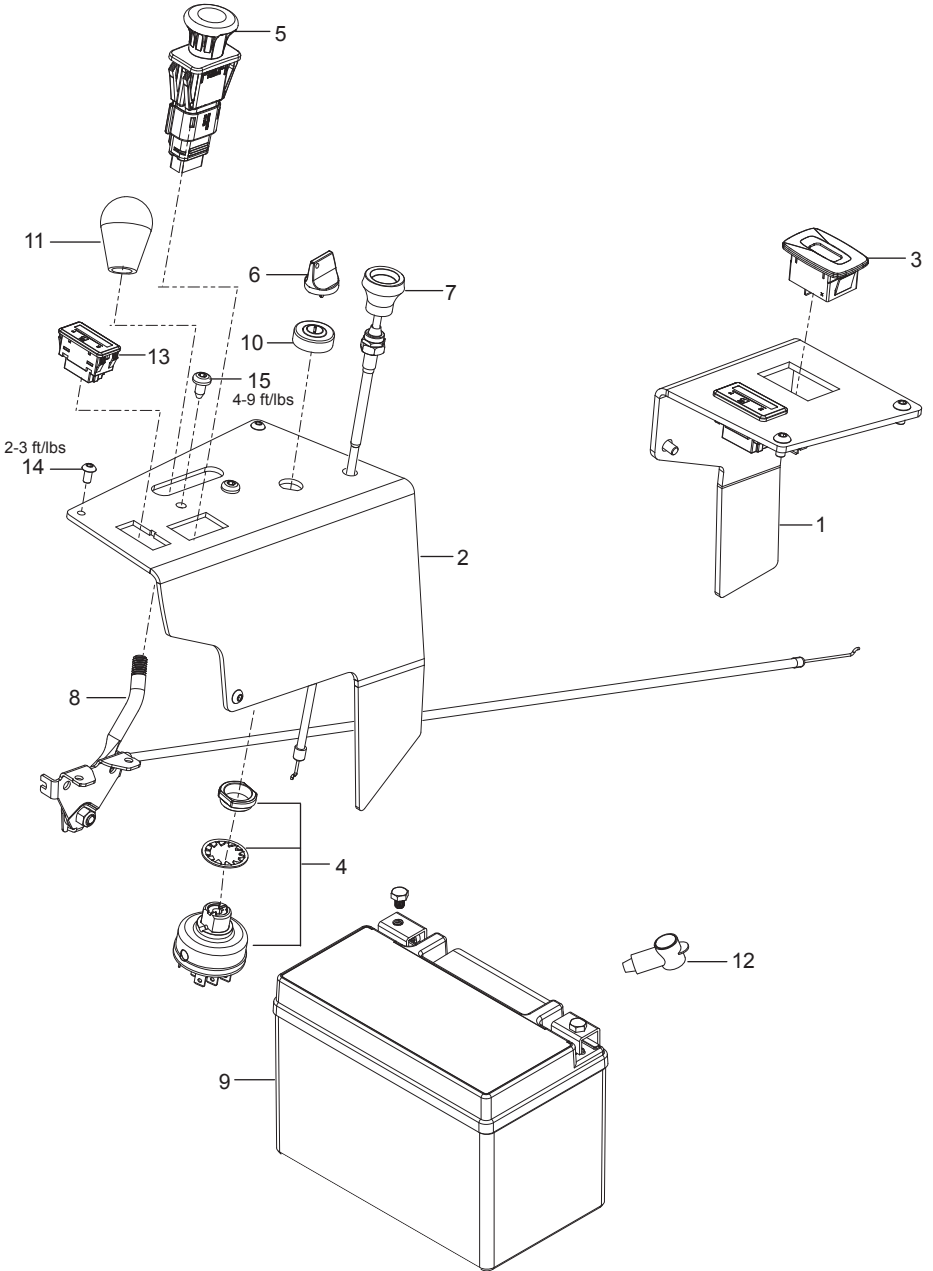

Ref.	Part No.	Qty	Description	Kit / Assy Includes
1	582 48 39-02	1	Panel, Control Left Gry	
2	582 48 36-02	1	Panel, Control Right Gry	
3	586 16 18-01	1	Meter, Service	
4	574 45 54-01	1	Switch, Ignition	
5	589 88 72-01	1	Switch, Blade	
6	574 45 55-01	1	Key, Ignition	
7	574 20 69-01	1	Control, Choke	
8	582 12 03-01	1	Control, Throttle	
9	589 81 95-01	1	Battery	
10	539 10 31-78	1	Cap, Ignition Switch Blk	
11	539 13 26-24	1	Knob	
12	539 10 27-59	1	Insulator	
13	501 62 88-01	2	Gauge, Fuel	
14	539 11 43-41	6	Screw #10-24 x 3/8 Socket Head Blk	
15	532 19 98-55	2	Screw 1/4-20 Panhead	
NOT SHOWN				
	581 34 51-01	1	Harness, Console	
	589 83 85-01	1	Adapter, Harness	
	574 51 40-01	1	Timer, Seat	
	590 63 21-01	1	Cable, Battery Red/Blk	

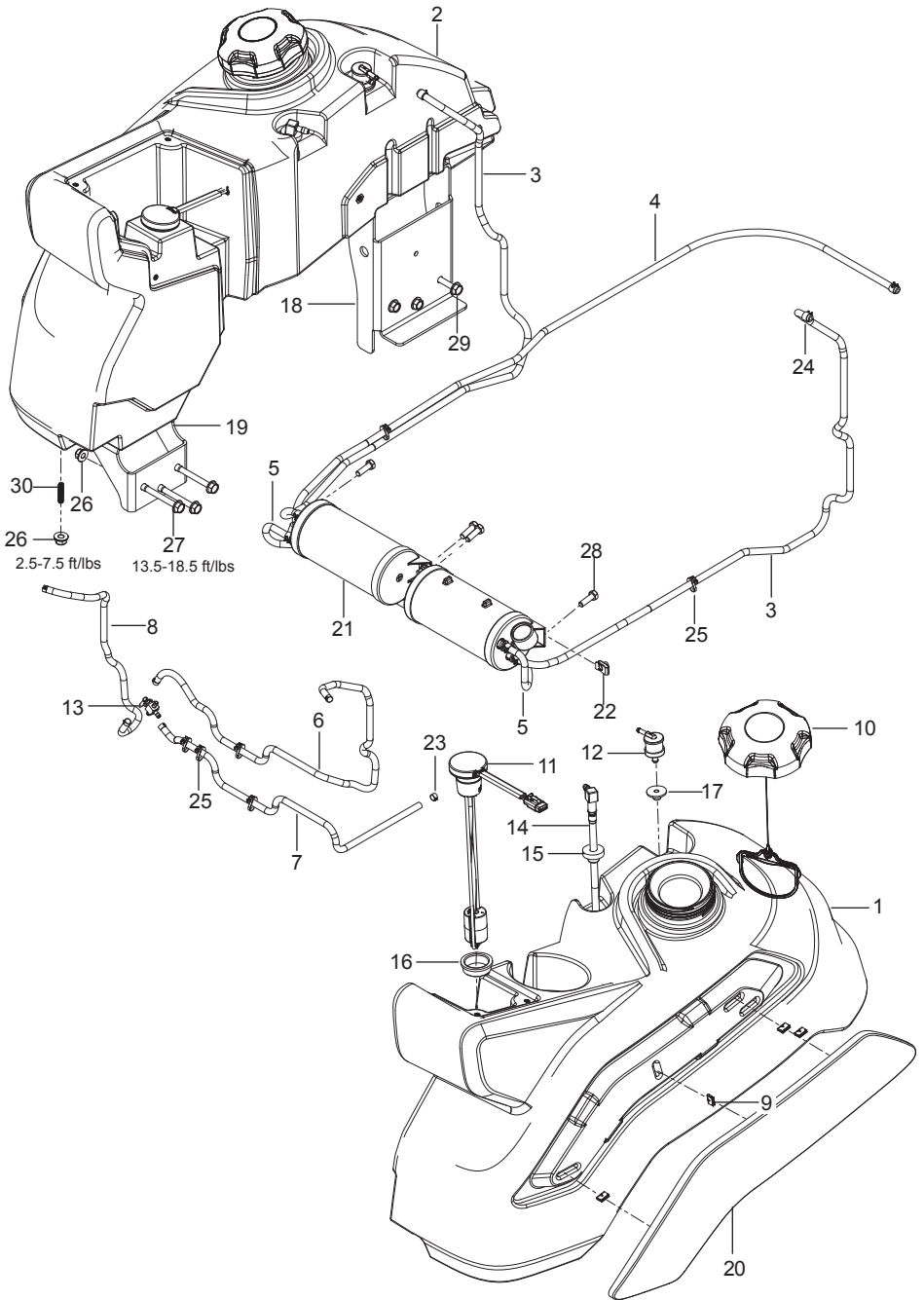

Ref.	Part No.	Qty	Description	Kit / Assy Includes
1	582 48 31-03	1	Assy, Tank Left	12, 13, 15, 16, 17, 18
2	582 48 17-03	1	Assy, Tank Right	12, 13, 15, 16, 17, 18
3	587 04 45-42	2	Hose 3/16 Vapor 42"	
4	587 04 45-55	1	Hose 3/16 Vapor 55"	
5	587 04 45-13	2	Hose 3/16 Vapor 13"	
6	587 04 48-46	1	Hose 1/4 x 46" Fuel	
7	587 04 48-33	1	Hose 1/4 x 33" Fuel	
8	587 04 48-24	1	Hose 1/4 x 24" Fuel	
9	582 48 26-01	8	Clip	
10	575 01 81-01	2	Cap, Fuel	
11	590 63 88-01	2	Sensor, Fuel Level	
12	576 61 81-01	2	Valve, Roll Over	
13	539 10 26-79	1	Valve, Fuel	
14	525 86 54-02	1	Assy, Fuel Tube Left	
	525 86 54-03	1	Assy, Fuel Tube Right	
15	532 00 36-45	2	Grommet, Fuel	
16	590 20 91-01	2	Grommet, Fuel Sensor	
17	584 64 82-01	2	Grommet, Valve	
18	582 48 15-02	2	Bracket, Tank Rear	
19	582 48 16-02	2	Support, Fuel Tank Front	
20	582 48 34-01	1	Cover, Fuel Tank Left	
	582 48 24-01	1	Cover, Fuel Tank Right	
21	585 97 74-02	2	Canister	
22	532 17 48-14	4	Retainer 1/4 Nut	
23	539 91 22-22	6	Clamp, Hose	
24	575 43 65-01	10	Clamp, Hose	
25	505 28 00-01	5	Tie w/ Clip	
26	539 11 28-99	20	Nut 5/16-18 Hex Flange Nyloc	
27	874 49 05-48	6	Bolt 5/16-18 x 3 Hex Flange Hd	
28	874 78 04-12	4	Bolt 1/4-20 x 3/4 Hex Hd	
29	817 49 05-16	6	Screw 5/16-18 x1 Hex Washer	
30	582 48 42-01	8	Screw 5/16-18 x 1-1/4 Set	
	NOT SHOWN			
	574 20 66-02	1	Tee 3/16 Fuel Line	

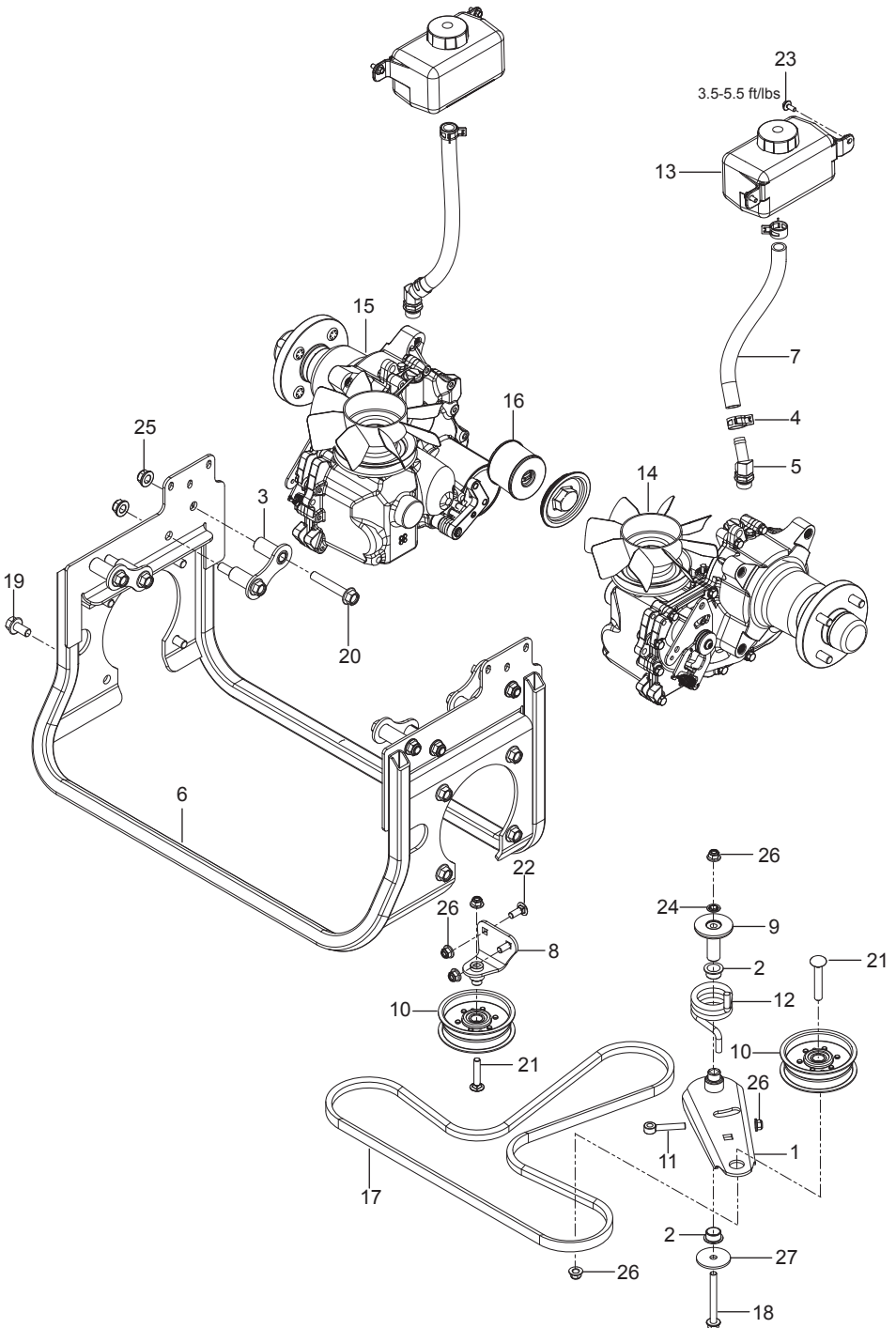

Ref.	Part No.	Qty	Description	Kit / Assy Includes
1	582 46 31-02	1	Arm, Idler	
2	501 60 37-01	2	Bearing, Flanged	
3	582 47 91-02	4	Bracket	
4	582 48 01-01	4	Clamp 15/16"	
5	582 48 03-01	2	Fitting 45°	
6	582 47 94-02	1	Frame	
7	582 48 02-03	2	Hose 5/8"	
8	586 93 38-02	1	Mount, Idler	
9	582 46 81-01	1	Mount, Idler Arm	
10	587 65 41-01	2	Pulley, Idler	
11	582 71 62-01	1	Rod End 3/8-16 x 3	
12	582 46 84-01	1	Spring, Torsion	
13	574 49 92-01	2	Tank, Expansion w/ Cap	
14	588 74 89-01	1	Transmission ZT-4400 Left	
15	588 74 89-02	1	Transmission ZT-4400 Right	
16	576 12 72-01	1	Filter w/ O-Ring	
17	582 48 04-01	1	V-Belt	
18	874 49 06-52	1	Bolt 3/8-16 x 3-1/2 Hex Flange Hd	
19	574 21 06-01	8	Bolt 1/2-13 x 1 Hex Flange Hd	
20	525 82 89-01	8	Bolt 1/2-13 x 3 Hex Flange Hd	
21	539 10 01-45	2	Bolt 3/8-16 x 2 Round Hd	
22	539 99 06-45	2	Bolt 3/8-16 x 1 Round Hd	
23	532 16 58-57	4	Screw Hex Washer Hd Torx	
24	539 91 38-47	1	Nut 3/8 Palnut	
25	521 99 11-01	8	Nut 1/2-13 Hex Flange Nyloc	
26	521 99 65-01	6	Nut 3/8-16 Hex Flange Nyloc	
27	819 13 32-10	1	Washer 10 Gauge	

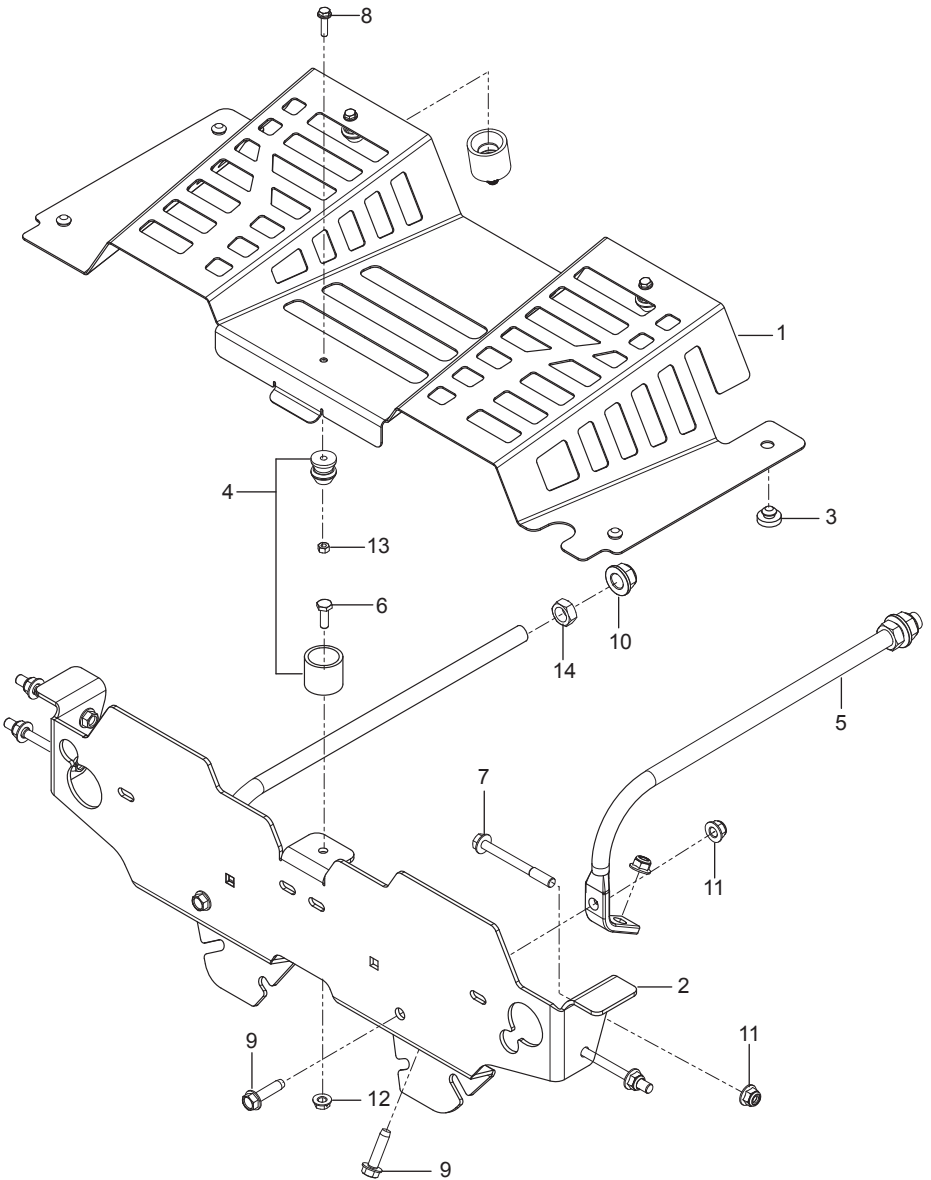



Ref.	Part No.	Qty	Description	Kit / Assy Includes
1	591 35 99-01	1	Shield, Fan w/ Safety Decal	
2	582 46 12-03	1	Bracket Org	
3	539 10 25-87	4	Grommet, Bumper	
4	582 46 17-01	3	Assy Holder	
5	582 46 13-03	2	Rod	
6	874 78 04-12	3	Bolt 1/4-20 x 3/4 Hex Hd	
7	874 49 05-48	4	Bolt 5/16-18 x 3 Hex Flange Hd	
8	503 20 00-01	3	Screw M5 x 20/20 10 9	
9	587 59 21-01	4	Screw 5/16-18 x 1-1/4 Thread roll	
10	521 99 11-01	2	Nut 1/2-13 Hex Flange Nyloc	
11	539 11 28-99	8	Nut 5/16-18 Hex Flange Nyloc	
12	532 19 17-30	3	Nut 1/4-20 Hex Flange Center Lock	
13	731 23 14-05	3	Nut-M5 x 8 Hex	
14	873 35 08-00	2	Nut 1/2-13 Jam Hex	

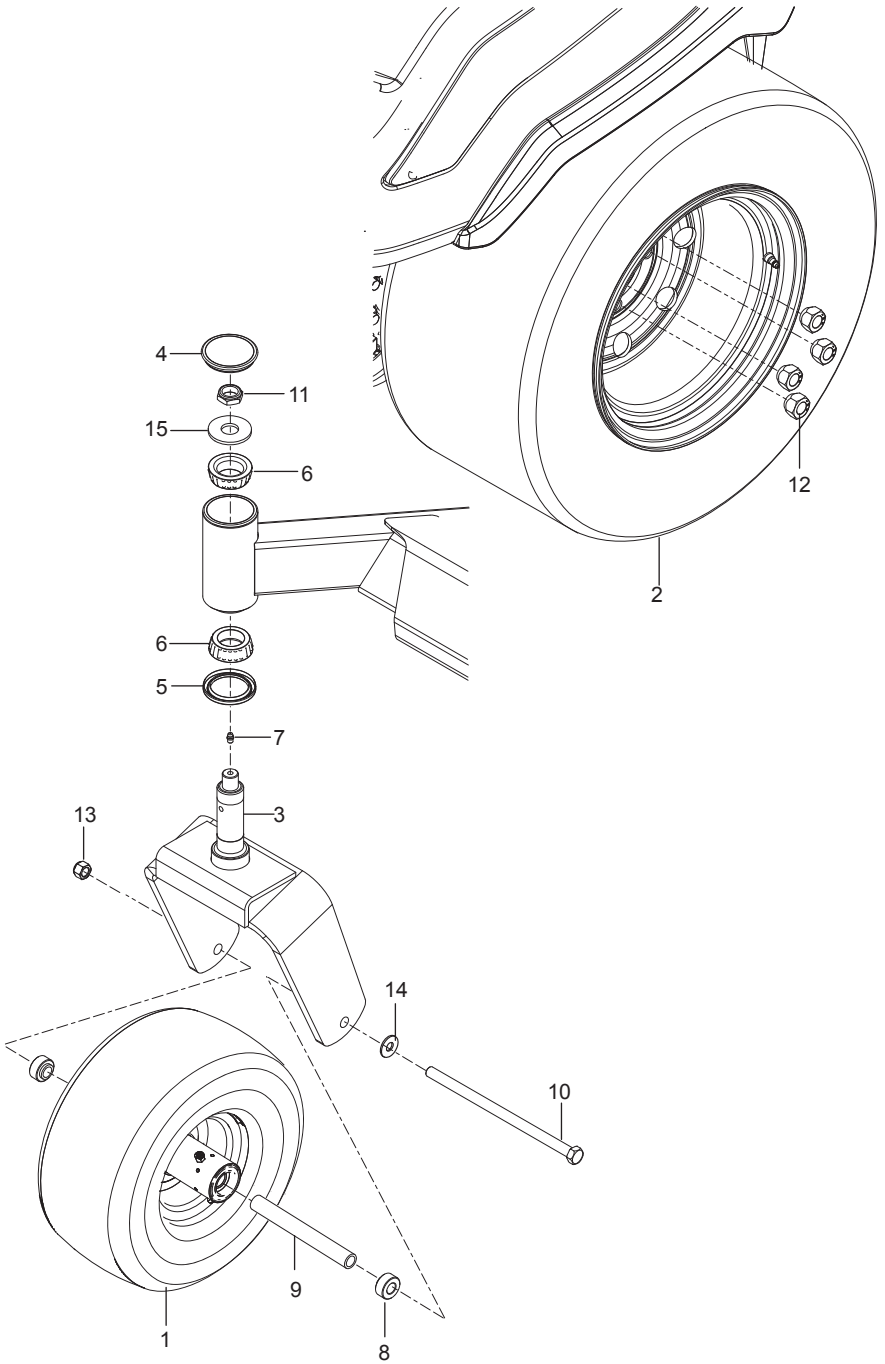

Ref.	Part No.	Qty	Description	Kit / Assy Includes
1	539 10 55-21	2	Assembly, Tire 13 x 6.5	
	539 10 55-22	2	Tire 13 x 6.5 Caster	
	522 90 51-03	2	Rim Caster	
2	522 90 50-01	2	Assembly, Tire 23 x 8.5-12	
	539 10 74-32	2	Tire 23 x 8.5 Turf Master	
	522 90 50-02	2	Rim 12 x 7.25 Neg Offset	
3	525 61 19-02	2	Yoke, Caster, Org	
4	510 03 40-01	2	Cap, Dust	
5	510 03 43-01	2	Seal, Bearing	
6	510 03 44-03	4	Cone	
7	539 10 14-74	2	Zerk	
8	590 69 07-01	4	Spacer, Axle	
9	590 70 49-01	2	Spacer, Hub	
10	539 10 55-17	2	Bolt 1/2-13 x 9-1/2 Hex Nyloc	
11	522 84 26-01	2	Nut 3/4-16 Hex Thin Nyloc	
12	587 65 39-02	8	Nut 1/2-20 Lug Grade 8	
13	873 93 08-00	2	Nut 1/2-13 Hex Center Lock	
14	539 99 02-50	2	Washer 1/2 SAE	
15	574 82 47-01	2	Washer 3/4 Hardened	

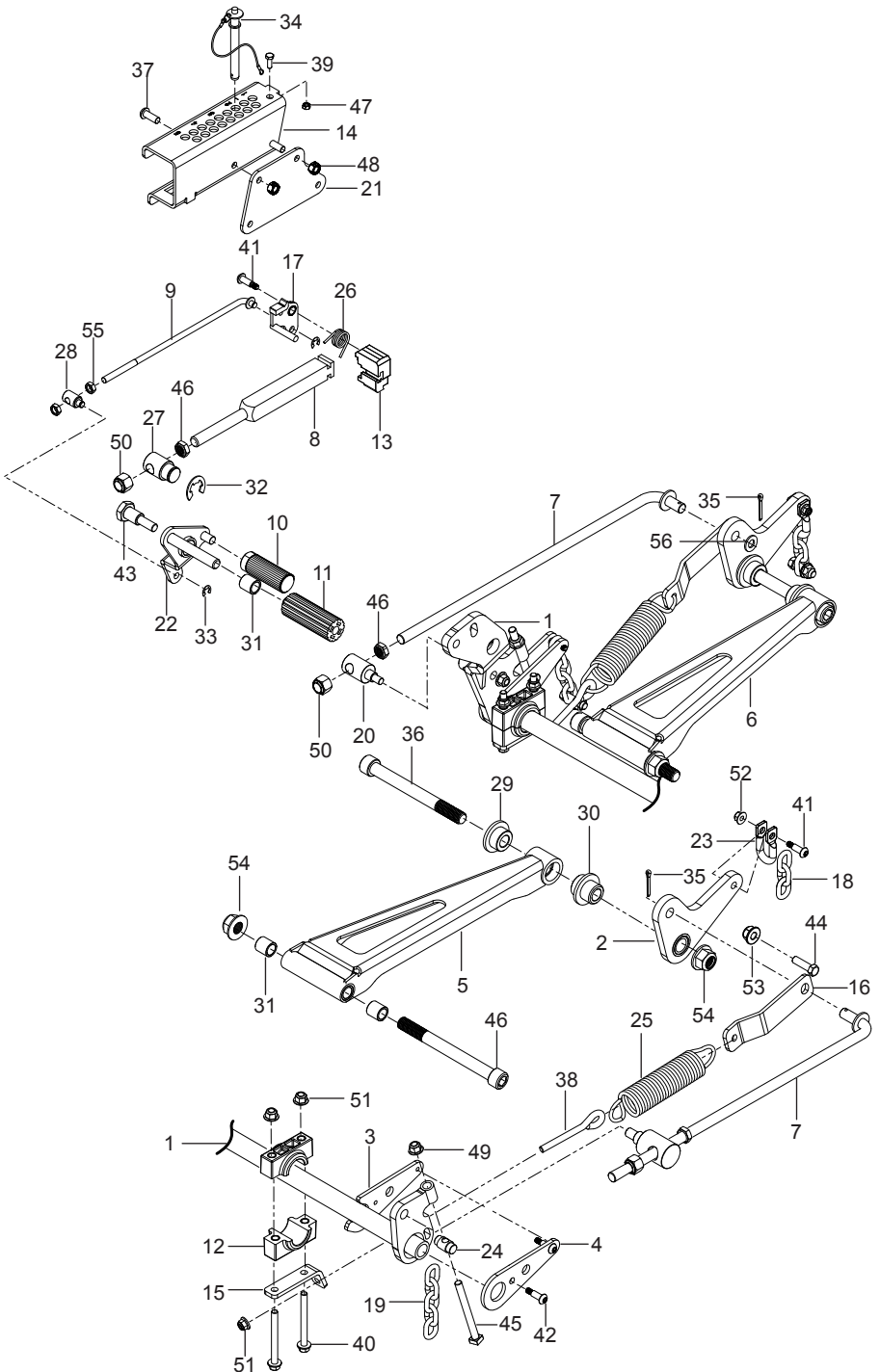

Ref.	Part No.	Qty	Description	Kit / Assy Includes
1	582 46 26-02	1	Shaft, Front Deck Lift	
2	592 65 40-02	2	Arm, Bell Crank Rear w/ Bearing	
3	582 46 54-02	2	Arm, Deck Lift Inner Blk	
4	582 46 39-02	2	Arm, Deck Lift Outer Blk	
5	582 46 20-01	1	Arm, Drawbar Left	
6	582 46 20-02	1	Arm, Drawbar Right	
7	582 46 46-01	2	Rod Connecting	
8	582 47 28-01	1	Rod Height Gauge	
9	582 47 14-01	1	Rod Release Connecting Toe	
10	510 40 83-01	1	Pedal, Deck Height	
11	510 08 95-01	1	Pedal, Deck Release	
12	510 02 39-02	4	Block, Pillow	
13	582 46 72-01	1	Block, Rod End	
14	582 46 69-02	1	Bracket, Height Org	
15	582 46 89-02	2	Bracket, Pillow Block Black	
16	582 47 27-02	2	Bracket, Spring Attach	
17	592 65 41-01	1	Lever, Lock w/ Bearing	
18	539 10 96-93	2	Chain 3" 3 Link Lift	
19	539 10 26-41	2	Chain 5" 3 Link Lift	
20	582 46 48-01	2	Pivot 3" Connecting Rod	
21	582 76 39-02	1	Plate, Height Gauge	11, 31
22	589 45 32-01	1	Assy, Release Pedal	
23	582 46 90-01	2	Shackle, Chain	
24	582 46 42-01	2	Trunnion	
25	582 46 91-01	2	Spring, Lift	
26	582 47 13-01	1	Spring, Torsion	
27	582 46 70-01	1	Swivel, Height Bar	
28	582 46 71-01	1	Swivel, Top Release	
29	582 46 99-01	2	Bushing 1-3/8 Deck Inner	
30	582 46 98-01	2	Bushing 1-1/2 Deck Outer	
31	510 08 92-01	5	Bushing 3/4 x 1 Sleeve	
32	539 91 27-30	1	E-Ring 1/2	
33	539 99 08-70	2	E-Ring 3/8	
34	590 46 55-01	1	Pin 3-1/2 Height Adjust	
35	539 10 28-89	2	Pin 1/8 x 2 Cotter	
36	582 46 67-01	4	Bolt 3/4-10 x 7-1/2 Socket Hd	
37	582 47 26-01	2	Bolt 3/8-16 x 1 Button Hd	
38	574 20 20-01	2	Bolt 3/8 x 4 Eye	
39	539 90 05-80	1	Bolt 1/4-20 x 3/4 Hex Hd	
40	589 78 60-01	4	Bolt 3/8-16 x 3-3/4 Grade 8	
41	501 06 41-02	3	Bolt 5/16-18 x 1 Shoulder	
42	501 06 41-01	4	Bolt 5/16-18 x 7/8 Shoulder	
43	510 40 82-01	1	Bolt 1/2-13 x 2-1/2 Shoulder	
44	539 10 11-75	4	Bolt 7/16-14 x 1-1/2 Hex Hd	
45	582 46 56-01	2	Bolt 7/16-14 x 4-1/2 Square Hd Grade 8	
46	589 67 77-01	3	Nut 5/8-11 Hex Thin Nyloc	
47	539 97 69-78	1	Nut 1/4-20 Hex	
48	539 99 05-46	2	Nut 3/8-16 Hex Center Lock	
49	539 11 91-24	4	Nut 7/16-14 Hex Nyloc	
50	539 11 03-40	3	Nut 5/8-11 Nyloc	
51	521 99 65-01	6	Nut 3/8-16 Hex Flange Nyloc	
52	539 11 28-99	2	Nut 5/16-18 Hex Flange Nyloc	
53	539 13 20-19	4	Nut 7/16-14 Hex Whiz Lock	
54	582 46 66-01	4	Nut 3/4-10 Hex Flange Nyloc	
55	539 10 87-32	2	Nut 3/8-24 Hex Jam Unf	
56	539 99 10-43	2	Washer 16 Gauge	

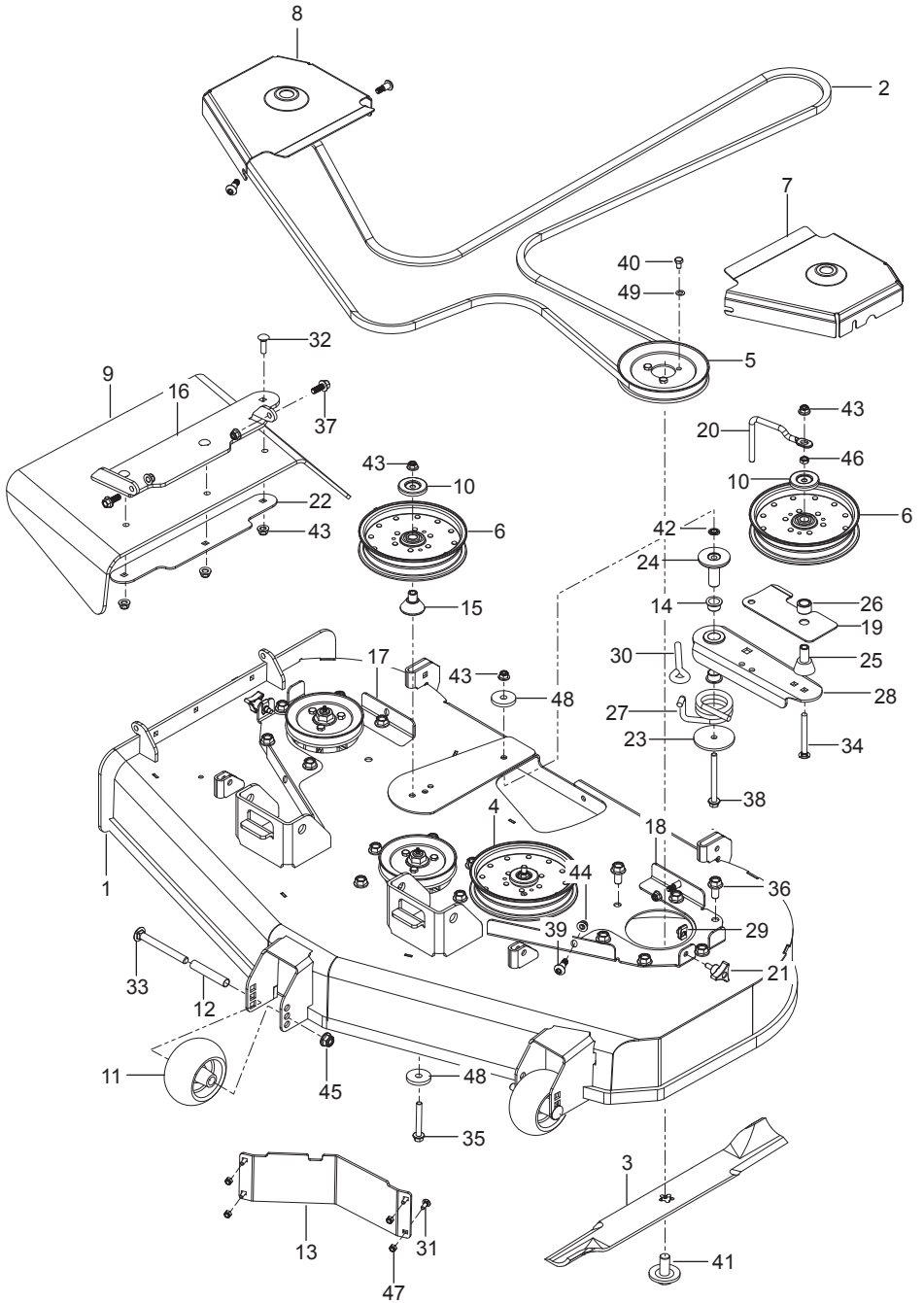

Ref.	Part No.	Qty	Description	Kit / Assy Includes
1	591 35 97-01	1	Deck w/ Safety Decals Org	
2	588 26 48-06	1	Belt, Deck	
3	581 05 55-01	3	Blade, Hi-Lift	
4	510 01 51-01	1	Pulley, Idler	
5	539 13 06-45	3	Pulley, Deck	
6	510 01 51-01	2	Pulley, Idler	
7	582 46 30-03	1	Shield, Belt Left	
8	582 46 30-06	1	Shield, Belt Right	
9	582 46 88-01	1	Shield, Deflector	
10	510 25 45-01	3	Shield, Dust	
11	574 16 96-01	2	Roller, Gauge	
12	574 19 64-01	2	Tube, Roller Axle	
13	510 43 75-02	1	Baffle	
14	539 13 15-18	2	Bearing, Flange	
15	510 26 37-01	2	Bearing, Idler Arm	
16	582 46 73-02	1	Bracket, Deflector Org	
17	582 46 32-03	1	Bracket, Pulley Cover Left	
18	582 46 32-04	1	Bracket, Pulley Cover Right	
19	582 47 25-02	1	Guard, Belt	
20	582 47 02-01	1	Keeper, Belt	
21	539 10 44-11	2	Knob w/ Stud	
22	590 52 37-02	1	Plate, Backing Discharge Blk	
23	582 46 64-01	1	Plate, Spring Retainer	
24	582 46 81-01	1	Shaft Mount Arm Idler	
25	582 46 83-01	1	Spacer	
26	589 45 52-01	1	Spacer, Pulley	
27	582 46 80-01	1	Spring, Deck Idler	
28	582 46 27-02	1	Arm, Idler	
29	539 10 47-63	2	Retainer-U Type 5/16-18	
30	574 20 20-01	1	Eyebolt 3/8 x 4	
31	539 11 56-20	4	Bolt 1/4-20 x 3/4 Round Hd Square Neck	
32	872 14 06-10	3	Bolt 3/8-16 x 1-1/4 Round Hd Square Neck	
33	510 02 23-01	2	Bolt 1/2-13 x 4-3/4 Round Hd Square Neck	
34	872 14 06-28	1	Bolt 3/8-16 x 3-1/2 Round Hd Square Neck	
35	874 49 06-44	2	Bolt 3/8-16 x 2-3/4 Hex Flange Hd	
36	574 21 06-01	18	Bolt 1/2-13 x 1 Hex Flange Hd	
37	525 61 28-01	2	Bolt 3/8-16 x 1 Hex Flange Hd	
38	521 99 66-01	1	Bolt 3/8-16 x 4 Hex Flange Hd	
39	582 47 64-01	4	Bolt 3/8 x 1/2 5/16-18 Shoulder	
40	539 13 03-15	9	Bolt 5/16-18 x 1/2 Hex Hd	
41	539 11 90-07	3	Bolt/Washer, Blade	
42	539 91 38-47	1	Nut 3/8 Retaining Blk	
43	521 99 65-01	10	Nut 3/8-16 Hex Flange Nyloc	
44	539 11 28-99	4	Nut 5/16-18 Hex Flange Nyloc	
45	521 99 11-01	2	Nut 1/2-13 Hex Flange Nyloc	
46	539 10 93-32	1	Nut 3/8-16 Hex Jam	
47	539 97 69-78	4	Nut 1/4-20 Hex Nyloc	
48	539 10 65-04	2	Washer, Harden	
49	539 10 96-00	9	Washer 5/16 Disc Spring	

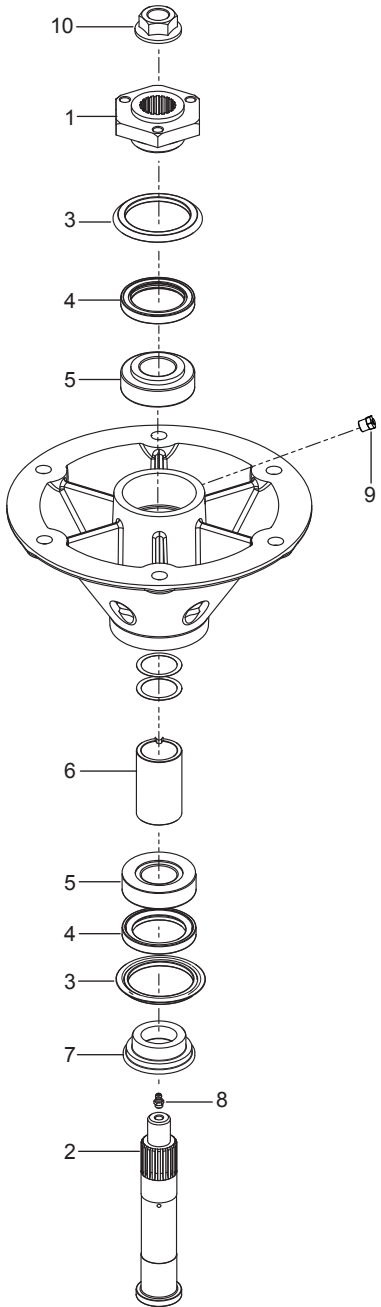
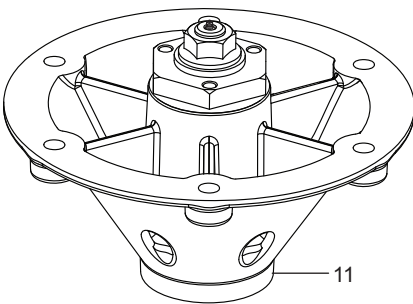



Ref.	Part No.	Qty	Description	Kit / Assy Includes
1	580 94 22-01	3	Hub	
2	580 94 21-01	3	Shaft, Spindle	
3	580 94 27-01	3	Seal, V Ring	
4	580 94 26-01	6	Seal, Shaft	
5	580 94 18-01	6	Bearing	
6	580 94 23-01	3	Spacer	
7	580 94 25-01	3	Carrier, Seal	
8	539 97 69-98	3	Zerk	
9	539 97 73-26	3	Valve, Grease Poppet	
10	539 13 06-53	3	Nut 3/4-16 Hex Flange	
11	580 94 33-05	3	Assembly, Spindle Aluminum	
NOT SHOWN				
	574 75 42-01	1	Kit, Bearing Assembly	
			When replacing the Spindle bearings, order the Bearing Assembly Kit to assure proper installation	

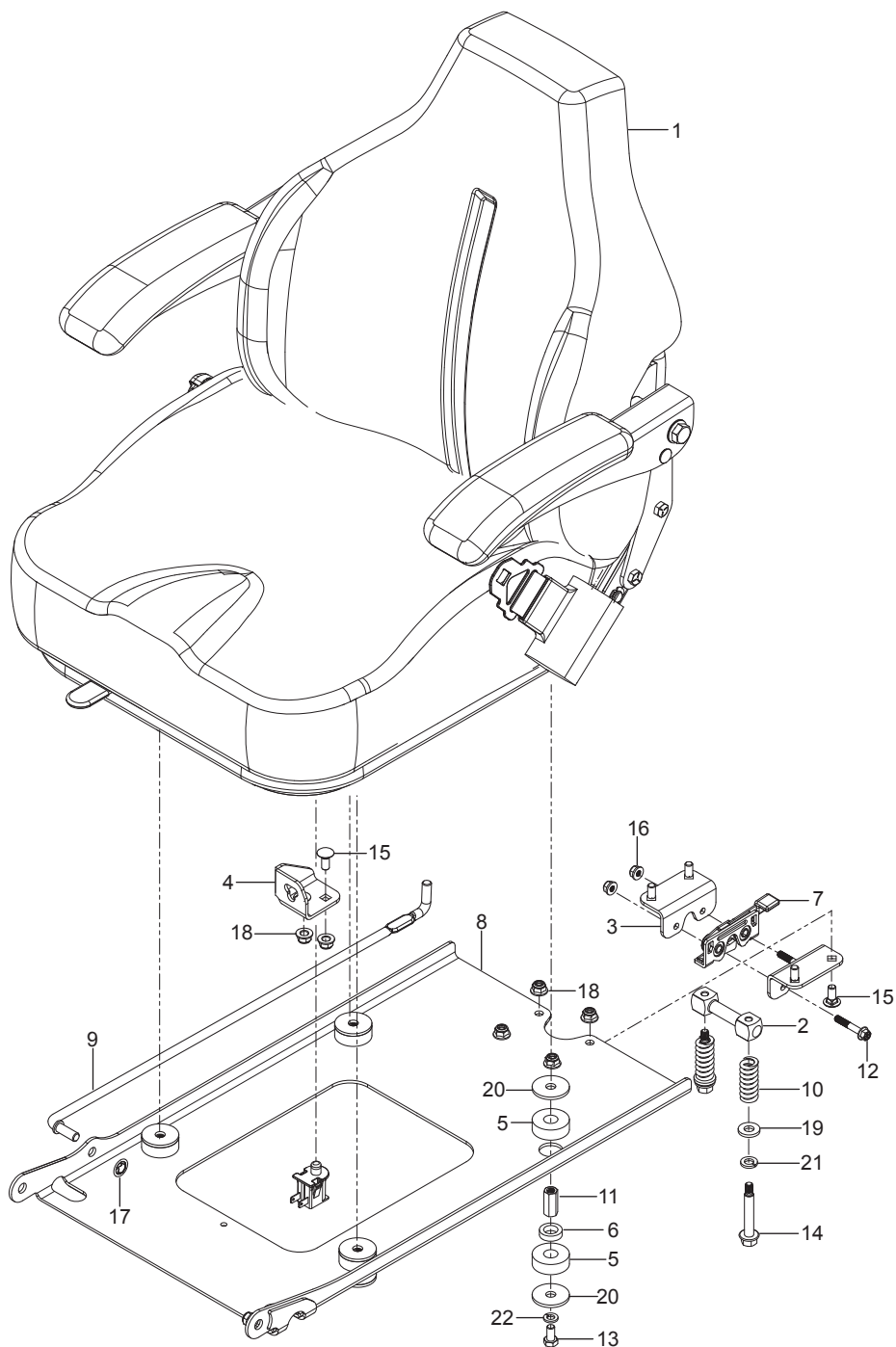

Ref.	Part No.	Qty	Description	Kit / Assy Includes
1	582 46 03-01	1	Seat	
2	582 47 88-01	1	Bar, Latch Seat	
3	582 47 82-01	2	Bracket, Latch	
4	590 55 50-02	1	Bracket, Seat Rod	
5	590 48 18-01	8	Isolator	
6	539 11 63-77	4	Insert, Iso-Mount	
7	590 37 35-01	1	Latch, Rotary	
8	590 50 68-02	1	Plate, Seat Mount	
9	590 50 72-01	1	Rod, Seat	
10	539 11 39-52	2	Spring	
11	582 47 81-01	4	Coupler 5/16-18 x 1-1/8 Hex	
12	582 47 85-01	2	Bolt 1/4-20 x 1-1/2 Hex Flange Hd Grade 8	
13	539 10 83-92	4	Bolt 5/16-18 x 5/8 Hex Hd	
14	582 47 89-01	2	Bolt 5/16-18 Threaded x 2-1/2 Shoulder	
15	539 99 03-16	6	Bolt 5/16-18 x 3/4 Round Hd	
16	582 47 86-01	2	Nut 1/4-20 Flange Nyloc Grade 8	
17	539 91 38-47	1	Nut 3/8 Palnut	
18	539 11 28-99	6	Nut 5/16-18 Hex Flange Nyloc	
19	522 02 34-01	2	Washer 3/8 Thick	
20	532 41 35-24	8	Washer 13/32 x 1 x 1/2	
21	539 99 01-18	2	Washer 3/8 Slotted Lock	
22	539 99 01-87	4	Washer 5/16 Slotted Lock	

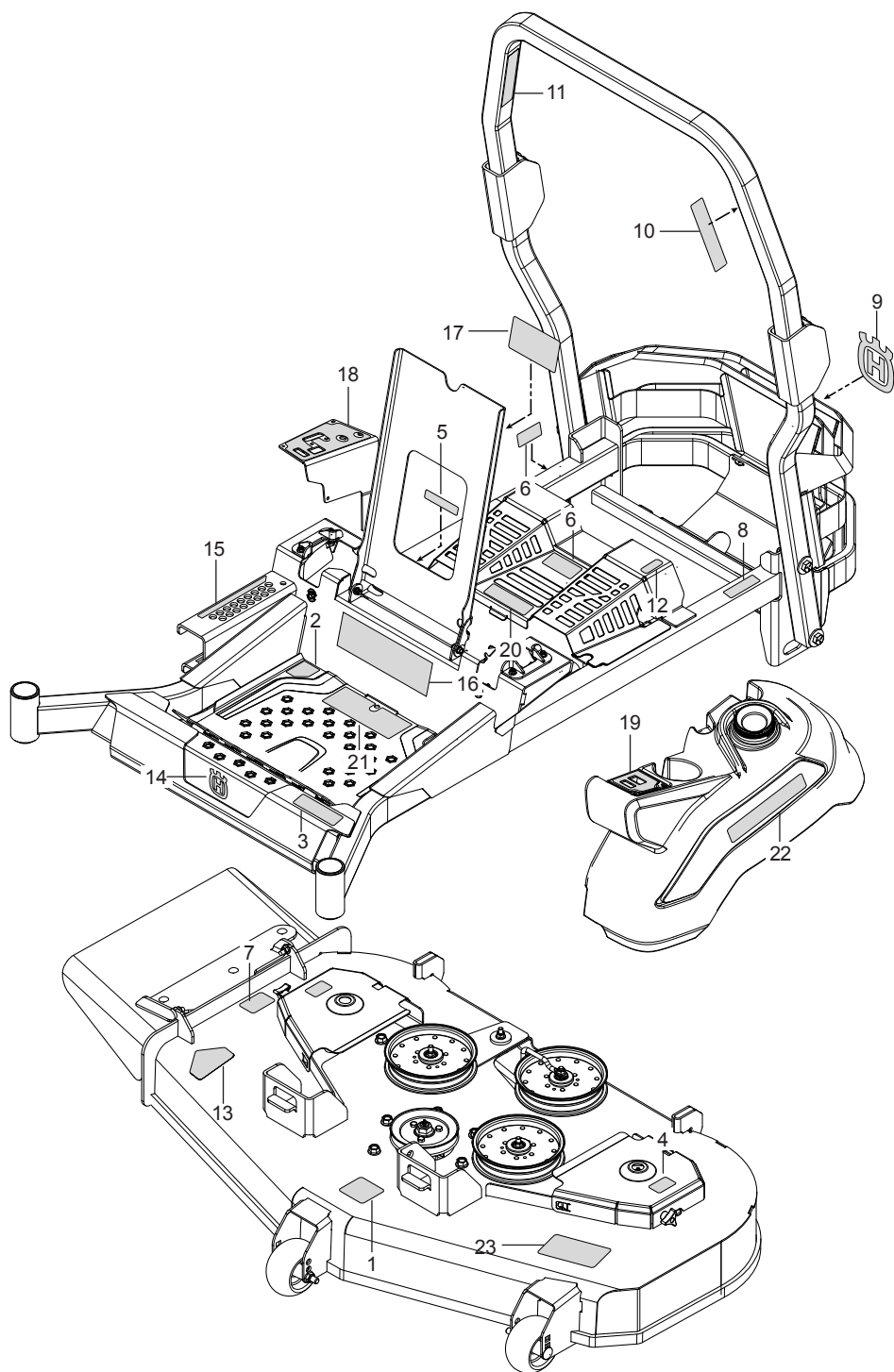

Ref.	Part No.	Qty	Description	Kit / Assy Includes
1	574 43 73-01	1	Decal, Belt Routing	
2	590 20 94-01	1	Decal, Motion/Brake Right	
	590 20 95-01	1	Decal, Motion/Brake Left	
3	590 25 23-01	1	Decal, Z548	
4	581 72 43-01	2	Decal, No Step	
5	539 10 57-45	1	Decal, Battery Warning	
6	539 10 57-44	2	Decal, Danger Belt	
7	581 72 44-01	1	Decal, Deflector Warning	
8	532 42 41-02	1	Decal, Spark Arrestor	
9	574 45 50-01	1	Decal, Crown Large	
10	574 56 90-06	1	Decal, ROPs	
11	574 56 90-02	1	Decal, ROPs, Warning	
12	574 56 94-01	1	Decal, Fuse	
13	584 90 46-01	1	Decal, Deck/Deflect Warning	
14	532 42 86-76	1	Decal, Crown Small	
15	590 79 93-01	1	Decal, Deck Height	
16	590 21 00-01	1	Decal, Commercial	
17	590 84 68-01	1	Decal, Maintance/Service	
18	590 21 03-01	1	Decal, Control Panel Right	
19	590 21 05-01	1	Decal, Control Panel Left	
20	590 20 97-01	1	Decal, Transmission Warning	
21	590 20 92-01	1	Decal, Starting	
22	577 46 90-01	2	Decal, Emblem	
23	539 12 13-22	2	Pad, Foot	
	NOT SHOWN			
	577 15 01-01	1	Decal, Fuel	







[www.husqvarna.com](http://www.husqvarna.com)

2017-10-01