

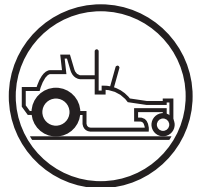

**Husqvarna**<sup>®</sup>

English



## **Operator Manual**

V 554 / 967 672602-00

Please read the operator manual carefully and make sure you understand the instructions before using the machine.

Gasoline containing a maximum of 10% ethanol (E10) is permitted for use in this machine. The use of gasoline with more than 10% ethanol (E10) will void the product warranty.



# CONFORMITY CERTIFICATES

## USA requirements

Labels are placed on the engine and/or in the engine compartment stating that the machine will fulfill the requirements. This is also applicable to special requirements for any of the states, (California emission rules etc.). Do not remove these labels. Certificates can also be supplied with the machine at delivery or written in the Engine manual. Take care of them as they are valuable documents.

 **WARNING!** Failure to follow cautious operating practices can result in dangerous injury to the operator or other persons. The owner must understand these instructions, and must let only approved persons who understand these instructions to operate the mower.

Each person operating the mower must be of sound mind and body and must not be under the influence of mind altering substances.

 **WARNING!** Engine exhaust, some of its constituents, and certain vehicle components contain or emit chemicals known to the State of California to cause cancer and birth defects or other reproductive harm.

 **WARNING!** Battery posts, terminals and related accessories contain lead and lead compounds, chemicals known to the State of California to cause cancer and birth defects or other reproductive harm. Clean your hands after handling.

 **WARNING!** Engine exhaust and certain vehicle components contain or emit chemicals considered to cause cancer, birth defects, or other reproductive system damage. The engine exhaust contains carbon monoxide, which is an odorless, colorless, poisonous gas. Do not use the machine in enclosed spaces.

When this product is worn out and no longer used, return it to the reseller or other party for recycling.

To implement improvements, specifications and designs can be altered without prior notification.

Note that no legal demands can be placed based on the information contained in these instructions.

Use only original parts for repairs. The use of other parts voids the warranty.

Do not modify or install non-standard equipment to the unit without consent from the manufacturer. Modifications to the unit may cause unsafe operations or damage the unit.

# CONTENTS

INTRODUCTION.....	4	OPERATION .....	16
Congratulations.....	4	Steering .....	16
Transport on Public Roads .....	4	Operating on Hills .....	17
Operating.....	4	Moving Machine By Hand.....	18
Stand On Walk Behind Option .....	4	Tracking - Speed.....	18
SYMBOLS AND DECALS.....	6	MAINTENANCE.....	19
SAFETY .....	7	Safety System.....	21
Personal Safety Equipment .....	8	Battery and Engine Access.....	21
Slope Operation.....	8	V-belts.....	22
Safe Handling of Gasoline .....	8	Tire Pressures.....	23
Transport.....	9	Adjusting the Mower Deck.....	23
Spark Arrestor.....	10	Cutting Blades .....	24
CONTROLS .....	11	Park Brake .....	24
Steering Controls .....	12	Neutral Adjustment .....	25
Operator Presence Control.....	12	Caster Wheels .....	26
Ignition Switch.....	12	LUBRICATION .....	27
Throttle Control .....	12	Engine Oil .....	28
Choke Control.....	12	Wheels and Blades.....	28
Blade Switch .....	12	Transaxle Fluid Change.....	29
Fuel Gauge.....	13	TROUBLESHOOTING .....	30
Service Meter.....	13	STORAGE.....	31
Fuses .....	13	SCHEMATIC .....	32
Stationary Bars .....	13	TECHNICAL DATA.....	33
Deck Lift Lever.....	13	SERVICE JOURNAL.....	35
Transport Latch.....	14		
Park Brake .....	14		
Fuel Tank .....	14		
Hydraulic Release Lever.....	15		
Fuel Shut Off Valve.....	15		

# INTRODUCTION

## Congratulations

Thank you for purchasing a Husqvarna stand-on mower. This machine is built for superior efficiency to rapidly mow primarily large areas. A control panel that the operator can easily access and a hydrostatic transmission regulated by steering controls each contribute to the machine's performance.

This manual is a valuable document. Read the contents carefully before using or servicing the machine. The following of instructions (use, service, maintenance) by all who operate this machine is important for the safety of the operator and others. It can also largely increase the life span of the machine and increase its resale value.

If you sell your machine, be sure to give the operator manual to the new owner.

The last chapter of this operator manual supplies a Service Journal. Make sure that service and repair work are documented. A correctly kept service journal reduces service costs for the maintenance and affects the machine's resale value. Please contact your dealer for more information. Take the operator manual along when the machine is taken to your dealer for service.

## General

In this operator manual, left and right, rearward and forward are used in relation to the machine's usual driving direction.

Continuous dedication to make our products better requires that specifications and design are subject to change without notice.

## Transport on Public Roads

Check applicable road traffic regulations before transporting on public roads. If the machine is transported, you must always use approved fastening equipment and make sure that the machine is correctly attached. DO NOT operate this machine on public roadways.

## Operating

This machine is constructed only for mowing grass on lawns and even ground without obstacles such as stones, tree stumps, etc. All other types of uses are incorrect. The manufacturer's directions concerning operation, maintenance, and repairs must be carefully followed.

Lawn mowers and all power equipment, can be potentially dangerous if used incorrectly. Safety requires good judgment, careful use in accordance with these instructions and common sense.

The machine must only be operated, maintained, and repaired by persons who know the machine's special qualities and who are also knowledgeable about the safety instructions. Use only approved repair parts to maintain this machine.

Accident prevention regulations, other general safety regulations, occupational safety rules, and traffic regulations must be followed without fail.

Unauthorized modifications to the design of the machine can absolve the manufacturer from liability for resulting personal injury or damage to property.

## Stand On Walk Behind Option

The mower is designed to be used as either a stand-on or walk behind unit. The latch on the rear of the unit releases the platform so the operator can ride the mower in a standing position. The latch will hold the platform securely out of the way if walk behind use is preferred.

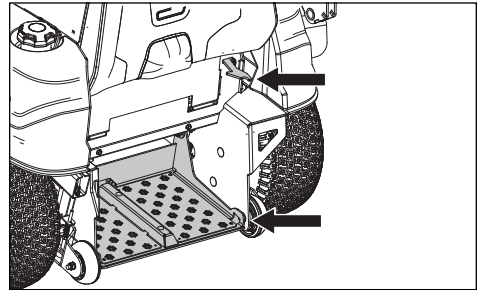

# INTRODUCTION

## Good Service

Husqvarna's products are sold throughout the world and only in specialized retail stores with complete service. This ensures that you as a customer receive only the best support and service. Before the product is delivered, the machine has, for example, been inspected and adjusted by your retailer. See the certificate in the Service Journal in this operator manual.

When you need spare parts or support in service questions, warranty issues, etc., consult the following professional:

This manual belongs to the machine with the manufacturing number:	Engine	Transmission

## Manufacturing Number

The machine's manufacturing number can be found on the printed plate affixed to the frame on the right side of the operator platform.

Stated on the plate, from the top are:

- The machine's type designation (I.D.)
- The manufacturer's type number (Model)
- The machine's serial number (Serial no.)

*Please have the type designation and serial number available when ordering spare parts.*

The engine's manufacturing number is located on the engine housing, behind the operator cushion.

The plate states:

- The engine's model.
- The engine's type.
- Code

*Please have these available when ordering spare parts.*

# SYMBOLS AND DECALS

These symbols are found on the machine and in the operator manual. Study them carefully until you know what they mean.

**IMPORTANT INFORMATION** Xxxx xxxxxx  
xxxxx xxxx xxxxxxxxxxx xxxxxx xxxxxxxxxxx.

**! WARNING!** Xxxx xxxxxx xxxxxx xxxxxx  
xxxxxxxx xxxxxx xxxxxxxxxxx.

Used in this publication to tell the reader of a risk of material damage, particularly if the reader neglects to obey the instructions in the manual. Used also when there is a possibility for misuse or misassembly.

Used in this publication to tell the reader of a risk of personal injury or death, particularly if the reader neglects to obey the instructions in the manual.



Fast



Slow



Fuel



Park Brake



Danger



Use protective glasses



Use protective gloves



Wear hearing protection



Do not stand here



Warning!  
Battery acid is corrosive, explosive and flammable

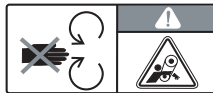

Warning!  
Do not touch parts



Warning!  
Do not use without deflector or grass catcher



Read the Operator Manual

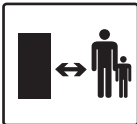

Keep a safe distance from the machine



Whole body exposure to thrown objects



Shut off the engine, remove the key before maintenance or repair



Use caution on slope to prevent tipping





Look before backing up and reverse slowly

# SAFETY

## Safety Instructions

These instructions are for your safety. Read them carefully.

 **WARNING!** THIS CUTTING MACHINE CAN AMPUTATE HANDS AND FEET AND THROW OBJECTS. FAILURE TO OBEY THE FOLLOWING SAFETY INSTRUCTIONS COULD RESULT IN SERIOUS INJURY OR DEATH.

 **WARNING!** CHILDREN CAN BE SERIOUSLY INJURED OR KILLED BY THIS EQUIPMENT. Carefully read and obey all the safety instruction that follow.

## Protecting Children

Tragic accidents can occur if the operator is not alert to the presence of children. Children are frequently attracted to the machine and the mowing activity. **Do not** think that children will stay where you last saw them.

- Keep children out of the mowing area and in the watchful care of a responsible adult **other than** the operator.
- Be alert and turn machine off if a child enters the area.
- Before and while backing, look behind and down for small children.
- Do not let children operate the machine.
- Use extreme care when going near blind corners, shrubs, trees, or other objects that can block your view of a child.

## General Operation

- Read, understand, and obey all instructions on the machine and in the manual before starting.
- It is recommended that someone knows that you are mowing and can give aid if there is an injury or accident.
- Those who operate, maintain, and/or service this machine must first read and understand this Operator Manual. Local laws can regulate the age of the user. The owner is responsible for training the users of this equipment.
- The owner and operator of this equipment can prevent accidents and is responsible for accidents or injuries occurring to themselves, other persons and/or property.
- Do not put hands or feet near rotating parts or under the machine. Keep away from the discharge opening at all times.

- Only let responsible adults, who are familiar with the instructions, to operate the machine.
- Clean the area of objects such as rocks, toys, wire, etc., which could be picked up and thrown by the blades.
- Be sure the area is has no bystanders before operating. Stop machine if someone enters the area.
- Do not mow in reverse unless fully necessary. Always look down and behind before and while backing.
- Do not point discharged material toward someone. Avoid discharging material against a wall or obstruction. Material can ricochet back toward the operator. Stop the blades when going across gravel surfaces.
- Do not operate machine without the full grass catcher, discharge guard, or other safety devices in place and working.
- Slow down before turning.
- Always turn off blades, stop engine and remove keys before dismounting.
- Do not carry passengers. The machine is only intended for use by one person.
- Operate the machine only in daylight or good artificial light.
- Disengage blades when not mowing. Shut off engine and wait for all parts to come to a full stop before cleaning the machine, removing the grass catcher or unclogging the discharge guard.
- Do not operate the machine while under the influence of alcohol or drugs.
- Look for traffic when operating near or going across roadways.
- Use more care when loading or removing the machine into a trailer or truck.
- Always wear eye protection when operating machine.
- Wear correct Personal Protective Equipment (PPE) while operating this machine, including (at a minimum) sturdy footwear, eye protection, and hearing protection. Do not mow in shorts and/or footwear with open toes.
- Data shows that operators age 60 years and above are involved in a large percentage of mower-related injuries. These operators must evaluate if they can safely operate the mower sufficiently to protect themselves and others from serious injury.
- Keep machine free of grass, leaves or other debris buildup which can touch hot exhaust or engine parts and burn. Do not let the mower

## SAFETY

deck plow leaves or other debris that can cause a buildup to occur. Clean oil or fuel spillage before operating or storing the machine.

- Let machine cool before storage.

**⚠️ WARNING!** When using the machine, approved personal protective equipment must be used. Personal protective equipment cannot remove the risk of injury but it will reduce the degree of injury if an accident does occur. Speak to your retailer for aid in choosing the right equipment.

### Personal Safety Equipment

- Make sure that first aid equipment is near at hand when using the machine.

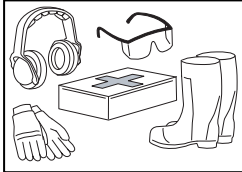

- Do not use the machine when barefoot.
- Always wear protective shoes or boots. Steel toe caps are recommended.
- Always wear approved protective glasses or a full visor when assembling or driving.
- Always wear gloves when handling the blades.
- Do not wear loose clothing that can become caught in moving parts.
- Use ear protectors to avoid damage to hearing.

### Slope Operation

Slopes are a major cause related to loss of control and tip-over accidents, which can result in severe injury or death. Operation on slopes requires more care. If you cannot back up the slope or if you feel uneasy on it, do not mow it.

- Mow across slopes (10 degrees maximum), not up and down.
- Look for holes, ruts, bumps, rocks, or other hidden objects. Uneven terrain could overturn the machine. Tall grass can hide obstacles.
- Select a low ground speed so it will not be necessary to stop while on the slope.
- Do not mow on wet grass. Tires can lose traction.
- Avoid starting, stopping, or turning on a slope. If the tires lose traction, disengage the blades and continue slowly straight down the slope.
- Move slowly and gradually on slopes. Do not make sudden changes in speed or direction, which could cause machine to tip over.

- Use more care while operating machine with grass catchers or other attachments; the stability of the machine can be affected.
- Do not use on steep slopes.
- Do not mow near drop-offs, ditches, or embankments. The machine could suddenly roll over if a wheel is over the edge or the edge caves in.

**⚠️ WARNING!** Do not drive across hills with slopes greater than 10 degrees. Do not drive up or down slopes.

### Safe Handling of Gasoline

To avoid personal injury or damage to property, use care in handling gasoline. Gasoline is very flammable and the vapors are explosive.

**⚠️ WARNING!** The engine and the exhaust system become very hot during operation. There is a risk for burns if touched. Let engine and exhaust system to cool before refueling.

- Do not fuel the machine indoors.
- Extinguish all cigarettes, cigars, pipes, and other sources of ignition.
- Use only approved gasoline containers.
- Do not remove gas cap or add fuel with the engine running. Let engine cool before refueling.
- Do not keep the machine or fuel container where there is an open flame, spark or pilot light such as on a water heater or other appliance.
- Before you start refueling, keep the risk of static electricity to a minimum by touching a metal surface.
- Do not fill containers in a vehicle or on a truck or trailer bed with plastic liner. Always put containers on the ground away from the vehicle when filling.
- Do not put too much fuel in the tank. Replace gas cap and tighten securely.
- Remove gas-powered equipment from the truck or trailer and refuel it on the ground. If this is not possible, refuel such equipment with a portable container, rather than from a gasoline dispenser nozzle.
- Keep the nozzle in contact with the rim of the fuel tank or container opening at all times until fueling is complete. Do not use a nozzle lock-open device.
- If fuel is spilled on clothing, change clothing immediately.



## SAFETY

- Do not start the engine near spilled fuel.
- Do not use gasoline as a cleaning agent.
- If leaks occur in fuel system, the engine must not be started until problem has been resolved.
- Check the fuel level before each use and leave space for the fuel to expand, because the heat from the engine and the sun can otherwise cause the fuel to expand and overflow.

### General Maintenance

- Do not use the machine indoors or in spaces lacking correct ventilation. The exhaust fumes contain carbon monoxide, an odorless and poisonous lethal gas.
- Make sure that the equipment is in good condition and that all nuts and bolts, especially those fastening the blade attachments, are correctly tightened and torqued.



**CAUTION!** Use protective glasses for maintenance work.

- Maintain or replace safety and instruction labels as necessary.
- Do not interfere with the intended operation of or reduce the protection given by a safety device. Check their operation regularly. DO NOT operate a machine with a safety device that does not operate correctly.
- Check grass catcher components and the discharge guard frequently and replace with manufacturer's recommended parts when necessary.



**WARNING!** The engine must not be started when protective plates for the mower deck's drive belt are removed.

- Do not change the settings of engine controllers and avoid running the engine at overly high engine speeds. If you run the engine too fast, machine components could be damaged.
- To reduce the risk of fire, keep machine free of grass, leaves or other debris buildup. Clean oil or fuel spills and remove fuel-soaked debris. Let machine cool before storing.
- Stop to do an inspection of the equipment if you run over or into anything. If necessary, make repairs before starting.
- Do not make adjustments or repairs with the engine running.
- The blades are sharp and can cause cuts and gashes. Wrap blades or use protective gloves when handling them.

- Check the park brake's operation regularly. Adjust and service as necessary.
- Do not work with the starter circuit if there is spilled fuel.
- Make sure that the fuel filler cap is mounted tightly and no flammable substances are kept in an open vessel.
- Sparking can occur when working with the battery and the heavy cables of the starter circuit. This can cause battery explosion, fire or eye injury. Sparking will not occur after the grounding cable (normally negative, black) is removed from the battery.

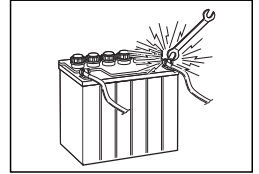

- Disconnect the grounding cable from the battery first and reconnect it last.
- Do not make a bridge short circuit across the starter relay to run the starter.
- Be very careful when handling battery acid. Acid on skin can cause serious corrosive burns. If you spill battery acid on your skin, rinse immediately with water.
- Acid in the eyes can cause blindness, contact a doctor immediately.
- Be careful when servicing the battery. Explosive gases form in the battery. Do not do maintenance on the battery when smoking or near open flames or sparks. The battery can explode and cause serious injury or damage.

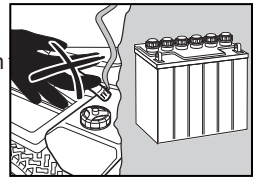

- The machine is tested and approved only with the equipment originally supplied or recommended by the manufacturer. Only use approved repair parts for the machine.
- The mulch blades must only be used in familiar areas when higher quality mowing is necessary.
- Regularly clean the deck and the underside of the deck. Avoid spraying engine and electrical components with water.

### Transport

- The machine is heavy and can cause serious crushing injuries. Be more careful when it is loaded on or removed from a vehicle or trailer.
- Use full width ramps for loading machine into a trailer or truck.
- Check and abide by local traffic regulations before transporting the machine on roads.

## SAFETY

- Use an approved trailer to transport the machine. Turn off the fuel supply. Fasten the machine down with approved devices such as bands, chains or straps at the tie down points on the mower.

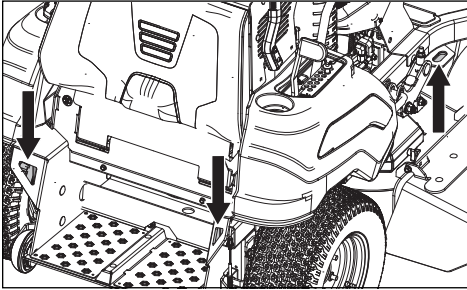

- Load the unit onto truck or trailer by reversing up ramps of sufficient strength using a slow speed. Do not lift! The machine is not intended to be lifted by hand.
- When loading or removing this machine, do not use more than the maximum recommended operation angle of 10 degrees.

**⚠ WARNING!** Use extreme care when loading the machine into a truck or trailer using ramps. There is the possibility of serious injury or death if the machine falls off the ramps.

**IMPORTANT INFORMATION** The park brake is not sufficient to lock the machine in place during transport. Make sure the machine is correctly fastened to the transport vehicle. Always reverse the machine onto the transport vehicle to avoid tipping it over.

### Spark Arrestor

This mower is equipped with an internal combustion engine and must not be used on or near unimproved forested, bush covered or grassy lands unless the engine's system is equipped with a spark arrestor meeting applicable local or state laws. Federal laws apply on federal lands. If a spark arrestor is used, it must be maintained in good working order by the operator.

A spark arrestor for the muffler is available through your authorized Husqvarna dealer.

# CONTROLS

This operator manual describes the Husqvarna commercial stand-on mower. The mower is fitted with a four-stroke overhead valve engine.

Transmission from the engine is made via belt-driven hydraulic pumps. Using the left and right steering controls, the flow is regulated and thereby the direction and speed.

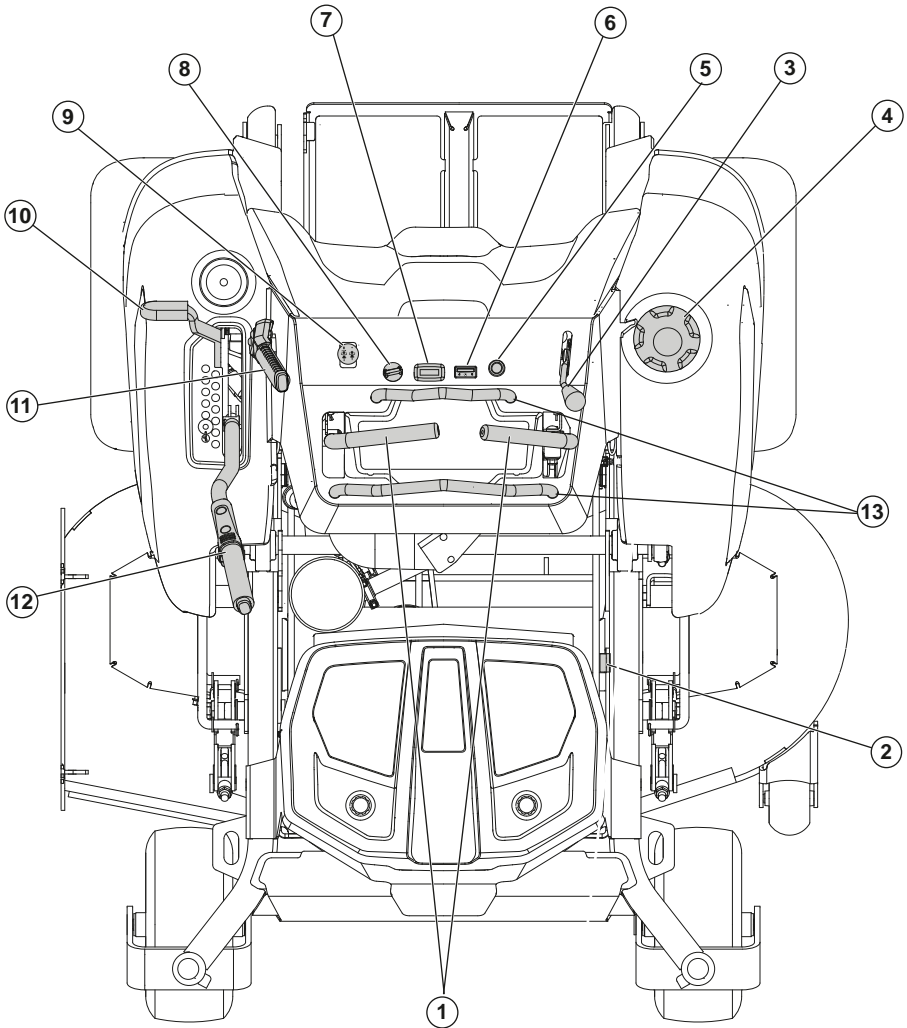

- |                            |                    |                     |
|----------------------------|--------------------|---------------------|
| 1. Steering controls       | 5. Choke control   | 10. Transport latch |
| 2. Hydraulic release lever | 6. Fuel gauge      | 11. Park brake      |
| 3. Throttle control        | 7. Service meter   | 12. Deck lift lever |
| 4. Fuel tank cap           | 8. Ignition switch | 13. Stationary bars |
|                            | 9. Blade switch    |                     |

# CONTROLS

## Steering Controls

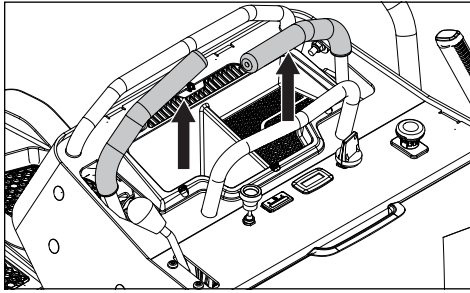

The machine's direction is variable using the two steering controls. The steering controls can be moved forward and back from a neutral position. See **Steering** in the *Operation* section.

## Operator Presence Control

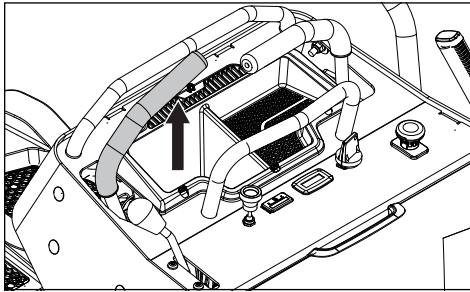

The left steering control is also the Operator Presence Control (OPC). The lever must be down and parallel with the right lever for operation.

## Ignition Switch

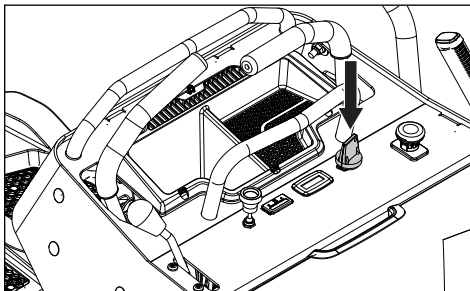

The ignition switch is used to start and stop the engine.

## Throttle Control

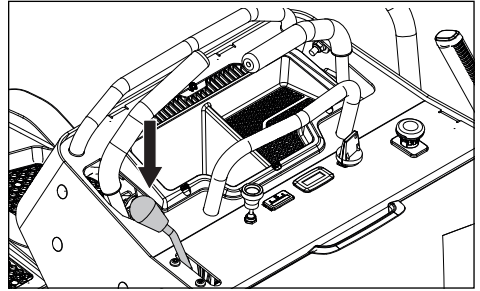

The throttle control regulates the engine speed and the rate of rotation of the blades, assuming the blade switch is pulled out.

To increase or decrease the engine speed, the control is moved forward or back respectively.

Avoid idling the engine for long periods, as there is a risk of fouling the spark plugs. **USE FULL THROTTLE WHEN MOWING**, for best mower performance and battery charging.

## Choke Control

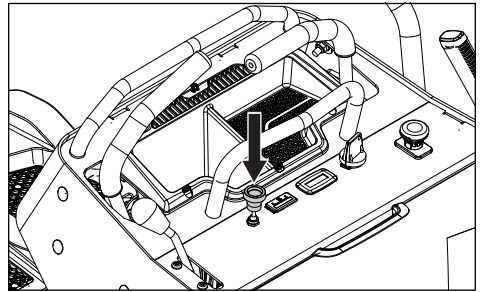

The choke control is used for cold starts to provide the engine with a richer fuel mixture. For cold starts, pull the control up.

## Blade Switch

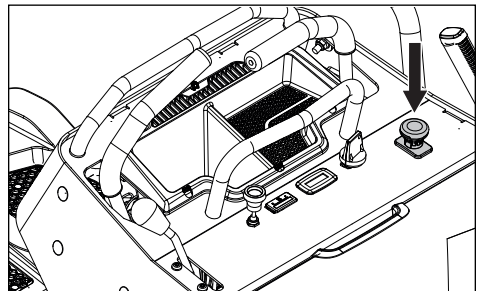

To engage the mower deck, pull the knob out; mower blades are disengaged when the knob is pressed down.

## CONTROLS

### Fuel Gauge

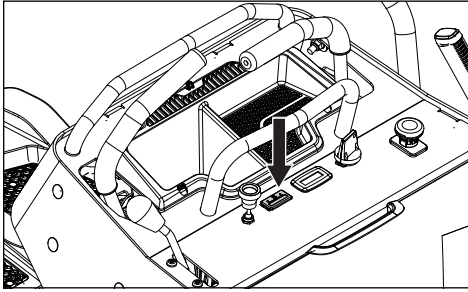

The fuel gauge for the fuel tank is located on the control panel. Sensors will indicate fuel levels. The meter will flash yellow when the tank level is approximately 3.8 litres (1.0 gallons).

### Service Meter

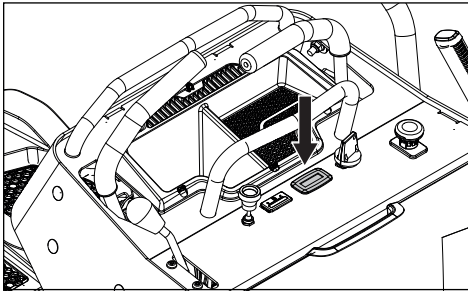

The service meter is located on the left hand control panel and shows the total operating time with the blades engaged.

After every 50 hours of operation, an oil can icon will appear and stay on for two hours, before an automatic reset occurs. To manually reset the meter, turn the key off and on five times at one second intervals. To service the engine and mower, see the Service Journal of this manual.

### Fuses

The fuse box is located behind the operator cushion. The fuses are the same type used in automobiles. Check the decal for amps and purposes.

### Stationary Bars

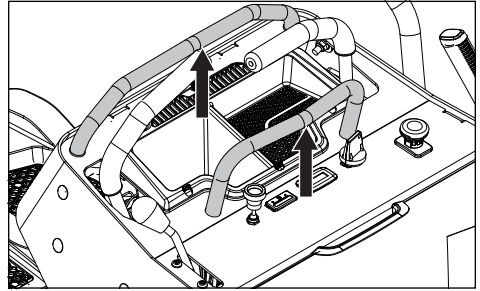

Located on the control panel, the stationary bars are fixed supports that assist the operator when using the steering controls.

### Deck Lift Lever

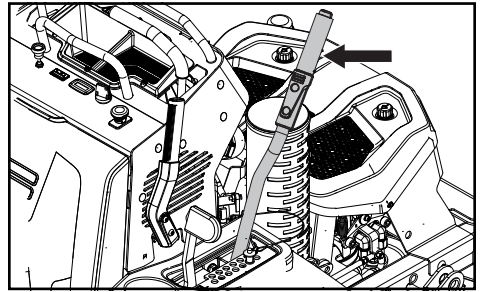

To set the deck cutting height, press the button on the top of the height pin to remove it. Slip the height pin into the hole for the desired cutting height.

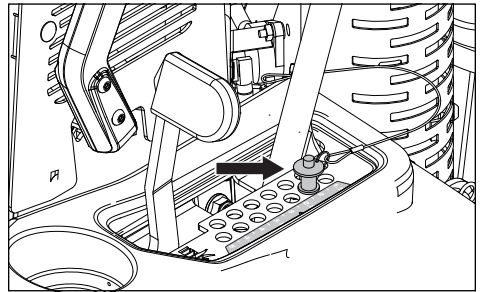

The cutting height can be set from 38 mm to 127 mm (1-1/2" to 5").

## CONTROLS

### Transport Latch

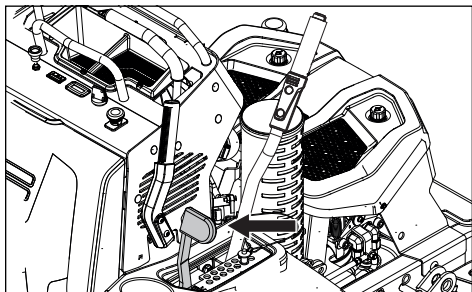

The transport latch will set the deck to the transport height of 5" when the lift lever is pulled back. The latch can also be used to mow at the 5" cutting height.

To release the deck left lever out of transport mode, push the transport latch forward.

**IMPORTANT INFORMATION** Always raise the deck to the highest position for transport.

### Park Brake

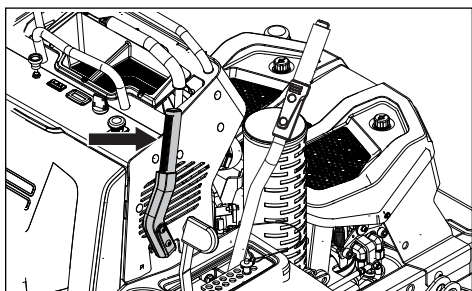

The park brake is found on the right side of the control console. Pull the lever back to engage the brake and push forward to release it.

**IMPORTANT INFORMATION** The machine must stand still when engaging the park brake. Release the park brake before moving the mower.

### Fuel Tank

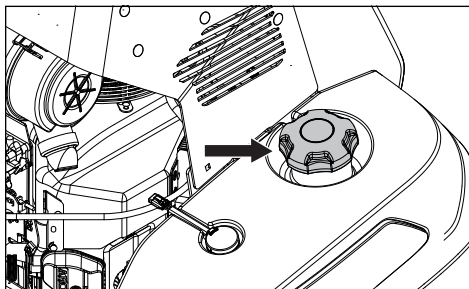

Read the safety instructions before refueling. The capacity for the tank is 24.6 litres (6.5 gallons).

Regularly check the gas cap gasket for damage and keep the cap properly tightened.

**WARNING!** Fill to bottom of filler neck. Do not overfill. Wipe off spilled oil or fuel. Do not store, spill or use gasoline near an open flame.

The engine will run on a minimum of 87-octane unleaded gasoline (no oil mix). Environmentally adapted alkylate gasoline can be used. See the *Technical Data* section in this manual concerning ethanol fuel. Methanol fuel is not allowed. Do not use E85 alcohol based fuel. Damage to the engine and components may occur.

When operating in temperatures below 0°C (32°F), use fresh, clean winter grade gasoline to help insure good cold weather starting.

**IMPORTANT INFORMATION** Experience indicates that alcohol blended fuels (called gasohol, ethanol or methanol) can attract moisture which leads to separation and formation of acids during storage. Acidic gas can damage the fuel system of an engine while in storage. To avoid engine problems, the fuel system must be emptied before storage of 30 days or longer. Drain the gas tank, start the engine and let it run until the fuel lines and carburetor are empty. Use fresh fuel the next season. See **Storage** for more information. Do not use engine or carburetor cleaners in the fuel tank or permanent damage may occur.

**WARNING!** The engine and the exhaust system, become very hot during operation. There is a risk for burns if touched. Let engine and exhaust system to cool before refueling.

**WARNING!** Gasoline is highly flammable. Observe caution and fill the tank outdoors.

## CONTROLS

### Hydraulic Release Lever

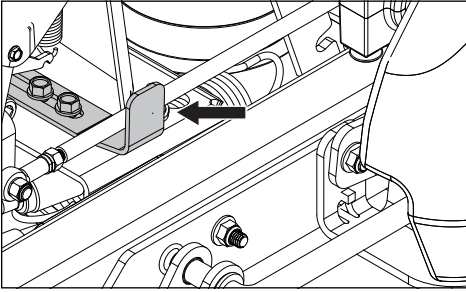

The hydraulic release allows the mower to be moved by hand when not running. See **Moving Machine By Hand** in the *Maintenance* section.

### Fuel Shut Off Valve

The fuel shut off valve is located on the right side next to the engine.

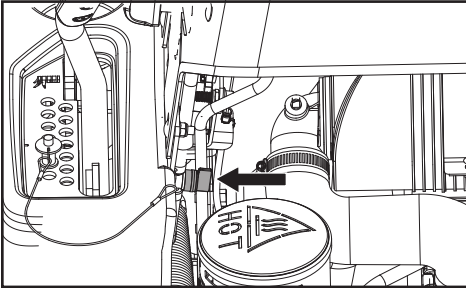

The valve is off when the handle tab is turned perpendicular to the fuel line.

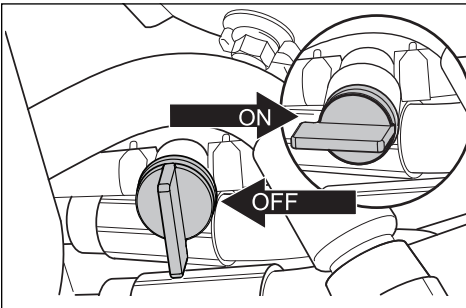

## OPERATION

Read the *Safety* section and following pages, if you are unfamiliar with the machine.

### Training

Due to unique steering capabilities, zero turn mowers are far more maneuverable than typical mowers.

Review this section fully before trying to move the mower under its own power. When first operating the mower or until becoming comfortable with controls, use a reduced throttle speed and reduced ground speed. DO NOT move control levers to the furthest forward or reverse positions during initial operation.

First time users must become familiar with the mower's movement on a hard surface, such as concrete or asphalt BEFORE trying to operate on turf.

### Steering

The direction and speed of the mower's movements are effected by the movement of the control lever(s) on each side of mower. The left lever controls the left wheel. The right lever controls the right wheel.

First time users must push the mower (see **Moving Machine By Hand** in the *Operation* section) to an open, flat area without other persons, vehicles or obstacles nearby.

#### To move forward and back

To move the unit under its own power, start the engine (see **Before Starting** in the *Operation* section). Adjust the engine speed to idle but do not engage the blades.

Slowly move the two control levers forward slightly. This will let the mower start moving forward in a straight line. Release the control levers back to the neutral position and stop the mower from moving.

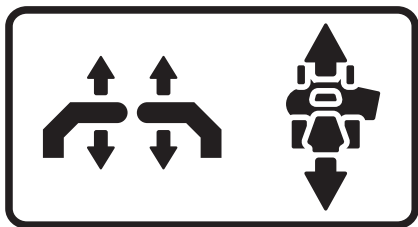

Pull back slightly on control levers, allowing the mower to move backwards. Release the control levers to the neutral position to stop the mower from moving.

#### To turn to the right

While moving in a forward direction, pull the right lever back towards the neutral position while maintaining the position of the left lever, this will slow the rotation of the right wheel and cause the machine to turn in that direction.

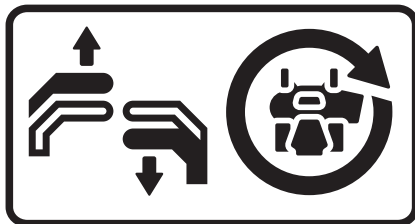

#### To turn to the left

While moving in a forward direction pull the left lever back towards the neutral position while maintaining the position of the right lever, this will slow the rotation of the left wheel and cause the machine to turn in that direction.

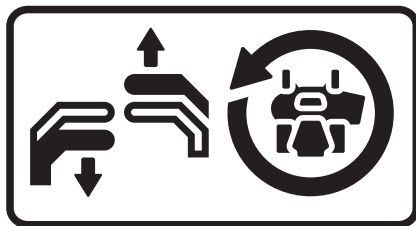

#### To zero turn

While moving in a forward direction, first pull the two control levers back until the mower stops or slows significantly. By moving one lever slightly forward and the other in the reverse, complete the turn.

### Before Starting

**⚠ WARNING!** Make sure the work area is free from stones and other objects that could be thrown by the rotating blades.

1. Read the sections on *Safety* and *Controls* before starting the machine.
2. Perform the daily maintenance before starting (see **Maintenance Schedule** in the *Maintenance* section).
3. Check that there is sufficient fuel in the fuel tank.
4. Adjust the mower deck to the desired cutting height. See **Cutting Height** in the *Maintenance* section.



## OPERATION

**⚠ WARNING!** The engine exhaust contains carbon monoxide, which is a odorless, colorless, poisonous gas. Do not use the machine in enclosed spaces.

The following conditions must be fulfilled before the engine can be started:

- The blade switch must be pressed down into the disengaged position.
- The park brake must be engaged.
- Both steering controls must be in the neutral position.

### Starting the Engine

1. Move the throttle lever to the mid throttle position. If the engine is cold, pull the choke control up.
2. Press in and turn the ignition key to the start position.

**IMPORTANT INFORMATION** Do not run the starter for more than five seconds each time. If the engine does not start, wait approximately ten seconds before trying again.

3. When the engine starts, immediately release the ignition key back to the run position. Slowly push in the choke control knob, if it was used to start a cold engine.
4. Set the engine speed with the throttle. Allow the engine to run at a moderate speed, approximately mid throttle, for a short time before use. **USE FULL THROTTLE WHEN MOWING** (no choke).

### Running

1. Move throttle control to full throttle (rabbit symbol).
2. Engage the OPC.

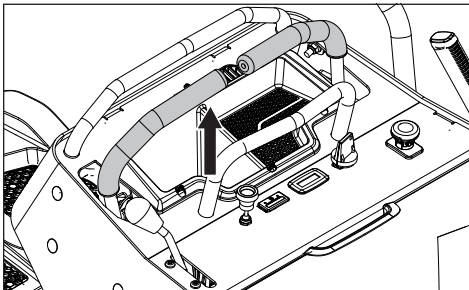

3. Release the park brake.
4. Engage the mower deck by pulling the blade switch up.

**⚠ WARNING!** Make sure that no one is near mower when engaging blade switch.

5. Grasp the speed control bar and the steering controls to start movement.

**NOTE:** When mowing in reverse, use the smaller bar at the rear of the console.

### Stopping the Engine

1. Move the steering controls back to the neutral position and release the OPC lever.
2. Disengage the mower deck by pressing the blade switch down.
3. Move the throttle to the minimum position (tortoise symbol).
4. Engage the park brake.
5. Turn the ignition key to the stop position and remove key. Remove the key when leaving the mower to prevent unapproved use.

### Operating on Hills

Read the Safety Instructions *Driving on Slopes* in the *Safety* section.

- Use the slowest speed possible before starting up or down hills.
- If stopping is fully necessary, pull steering controls into the neutral position.
- Pull the steering controls back to the center of the mower and push forward to regain forward movement.
- Try not to stop or change speed on hills.
- Make all turns slowly.

**⚠ WARNING!** Do not use the mower on terrain that slopes more than 10 degrees. Mow slopes side to side, never up and down. Avoid sudden directional changes.

### Mowing Tips

- Find and flag rocks and other fixed objects to avoid collisions.
- Start with a high cutting height and reduce it until the desired mowing result is attained. Cut the average lawn to 6.4 cm (2-1/2") during the cool season and over 7.6 cm (3") during the hot months. For healthier and better looking lawns, mow often after moderate growth.
- For best cutting performance, mow grass over 15.2 cm (6") in height twice. Make the first cut relatively high; the second to the desired height.
- The mowing result will be best with a high engine speed (the blades rotate rapidly) and low speed (the operator moves slowly). If the grass is not too long and dense, the operating

## OPERATION

speed can be increased without negatively affecting the mowing result.

- The finest lawns are obtained by mowing often. The lawn becomes more even and the grass clippings more evenly distributed over the mown area. The total time taken is not increased as a higher operating speed can be used without poor mowing results.
- When mowing large areas, start by turning to the right so that clippings will discharge away from shrubs, fences, driveways, etc. After one or two rounds, mow in the opposite direction making left hand turns until finished.

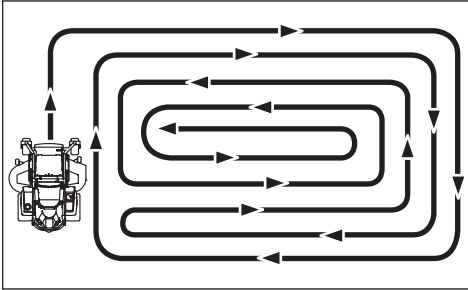

- Avoid mowing wet lawns. The mowing result is poorer because the wheels sink into the soft lawn, clumps build, and grass clippings fasten under the cowlings.
- Hose the mower deck underside with water after each use. When cleaning, the mower deck shall be raised into the transport position. Make sure the mower is cooled and the engine is off.
- Use compressed air to clean top surface of the deck. Avoid flooding water on top surface, engine and electrical components.
- When the mulching kit is used, it is important that the mowing interval is more frequent.

**⚠ WARNING!** Do not make adjustments unless:

- the engine is stopped,
- the park brake is engaged
- the ignition key is removed,

### Moving Machine By Hand

When pushing or pulling the mower with the engine not running, engage the hydraulic release lever.

**⚠ CAUTION!** With the hydraulic release engaged, the mower will have unrestricted motion if the parking brake is not engaged. Do not use the release lever if the mower is not on a level surface.

Access the lever on the left side of the unit. Set the deck to the lowest position when engaging the bypass linkage. To engage, slide the lever out.

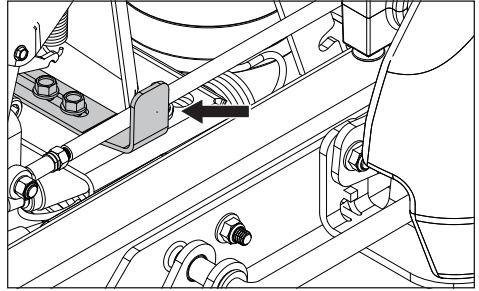

Load the machine into truck or trailer by driving up ramps in low gear. DO NOT LIFT! The machine is not intended to be lifted by hand.

**⚠ WARNING!** Use extreme caution when loading the machine into a truck or trailer using ramps. There is the possibility of serious injury or death if the machine falls off the ramps.

### Tracking - Speed

1. Pull the retaining clip out of the vertical control rod.

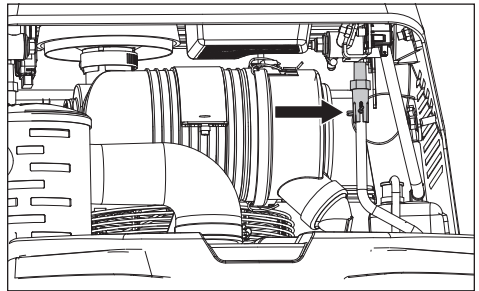

2. Adjust the nylon coupler until the desired speed is achieved. When the unit tracks straight and is at appropriate maximum forward speed, reinsert the retaining clip to lock the coupler in place.

# MAINTENANCE

## Maintenance Schedule

Following is a list of maintenance procedures that must be performed on the machine. For those points not described in this manual, visit an authorized service workshop. An annual service

carried out by an authorized service workshop is recommended to maintain your machine in the best possible condition and to ensure safe operation.

Read **General Maintenance** in the *Safety* section.

MAINTENANCE	DAILY		AT LEAST ONCE EACH YEAR	MAINTENANCE INTERVAL IN HOURS		
	BEFORE	AFTER		50	250	500
<b>CHECK</b>						
Park brake for adjustment	●		●	●	●	●
Engine's oil level (every refueling)	■					
Safety system	●					
For fuel and oil leakages	◆					
For damage		◆		◆	◆	◆
For loose hardware (screws, nuts)		●				
For mower deck damage		●				
Tire pressures		●		●	●	●
Battery connections			●	●	●	●
<b>CLEAN</b>						
Engine's cooling air intake		■				
Under the mower deck		●		●	●	●
Around the engine		◆		◆	◆	◆
Around belts, belt pulleys		◆		◆	◆	◆
Engine's cooling air intake <sup>1)</sup>			■	■	■	■
Air cleaner foam pre-filter <sup>1)</sup>			■		■	
Air cleaner paper filter cartridge <sup>1)</sup>			■		■	
<b>ALSO</b>						
Inspect muffler/spark arrestor			◆	◆	◆	◆
Start the engine & blades, listen for unusual sounds		◆				
Sharpen <sup>2)</sup> / Replace mower blades			●	●	●	●

● = Described in this manual

◆ = Not described in this manual

■ = Refer to the engine manufacturer's manual

<sup>1)</sup> In dusty conditions, cleaning and replacement are required more often.

<sup>2)</sup> Performed by authorized service workshop.



**WARNING!** Before performing service or adjustment:

- Engage the park brake.
- Place the blade switch in the disengaged position.
- Turn the ignition switch to OFF position and remove the key.
- Make sure the blades and all moving parts have stopped.

# MAINTENANCE

MAINTENANCE	DAILY		AT LEAST ONCE EACH YEAR	MAINTENANCE INTERVAL IN HOURS		
	BEFORE	AFTER		50	250	500
<b>CHECK</b>						
Throttle and choke cables for adjustment					■	
Mower deck for adjustment			●			●
Condition of belts, belt pulleys			●		●	
Caster wheels (every 200 hours)			●		●	
Hydraulic oil level	●					
Engine valve clearance <sup>4)</sup>			◆			◆
<b>CHANGE</b>						
Spark plugs			■		■	
Engine oil <sup>1)</sup>			■	■		
Engine oil filter			■		■	
Fuel filter			■		■	
Paper air filter <sup>2)</sup>			■		■	
Air cleaner foam pre-filter <sup>2)</sup>			■			
Air cleaner paper filter cartridge <sup>2)</sup>			■		■	
Hydraulic oil <sup>3)</sup>			●		●	●
Hydraulic oil filter <sup>3)</sup>			●		●	●
<b>ALSO</b>						
Dismantle and inspect starter <sup>4)</sup>						◆
Perform the 500-hour service <sup>4)</sup>			◆			◆

● = Described in this manual

◆ = Not described in this manual

■ = Refer to the engine manufacturer's manual

<sup>1)</sup> First change after 8–10 hours. When operating with a heavy load or at high ambient temperatures, replace every 50 hours.

<sup>2)</sup> In dusty conditions, cleaning and replacement are required more often.

<sup>3)</sup> Maintenance interval determined by type of oil used. See **Qualified Hydraulic Oils** in the *Lubrication* section.

<sup>4)</sup> Performed by authorized service workshop.

**⚠ WARNING!** Do not short battery terminals by allowing a wrench or other objects to contact the two terminals at the same time. Before connecting battery, remove metal bracelets, wristwatch bands, rings, etc. Positive terminal must be connected first to prevent sparks from accidental grounding.

## Hardware

Check daily. Inspect the entire machine for loose or missing hardware.

# MAINTENANCE

## Safety System

The machine is equipped with a safety system that prevents starting or driving under the following conditions.

The engine can only be started when:

- the mower deck is disengaged.
- the park brake is engaged.

Make daily inspections to make sure that the safety system works by trying to start the engine when one of the conditions is not met. Change the conditions and try again.

Make sure the engine stops when the park brake is not engaged and the operator leaves the seated position.

Make sure the engine stops if the mower blades are engaged and the driver leaves the seated position.

## Battery and Engine Access

The operator cushion can be lowered or removed for access to the battery and engine.

To lower the cushion, release the latch at the lower right side and tip the cushion down.

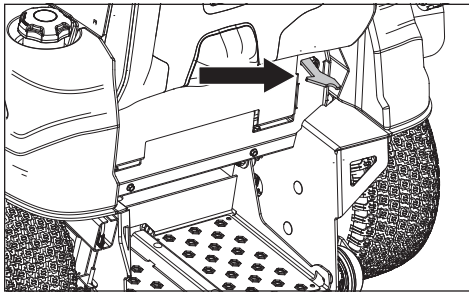

To remove, tip the lowered cushion up slightly and lift the back edge up.

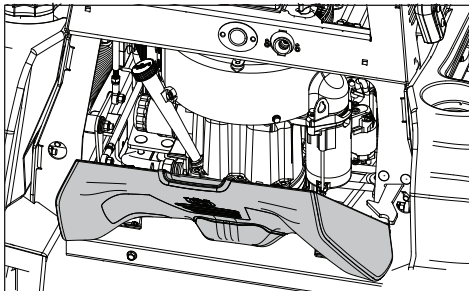

If the battery is too weak to start the engine, it must be recharged.

## Jumper Cable Use

1. Connect each end of the RED cable to the POSITIVE (+) terminal on each battery, taking care not to short against chassis.
2. Connect one end of the BLACK cable to the NEGATIVE (-) terminal of the fully charged battery.
3. Connect the other end of the BLACK cable to a good CHASSIS GROUND on the mower with the discharged battery, away from the fuel tank and battery.

## To remove cables, reverse order

1. Remove BLACK cable first from chassis and then from the fully charged battery.
2. Remove RED cable last from the two batteries.

The mower is equipped with a maintenance free battery and does not need servicing. However, periodic charging of the battery with an automotive type battery charger will extend its life.

- Keep battery and terminals clean.
- Keep battery bolts tight.
- See chart for charging times.

STD BATTERY	STATE OF CHARGE	APPROXIMATE CHARGING TIME* TO FULL CHARGE AT 80° F			
		Maximum Rate at:			
		50 Amps	30 Amps	20 Amps	10 Amps
12.6V	100%	- FULL CHARGE -			
12.4V	75%	20 min.	35 min.	48 min.	90 min.
12.2V	50%	45 min.	75 min.	95 min.	180 min.
12.0V	25%	65 min.	115 min.	145 min.	280 min.
11.8V	0%	85 min.	150 min.	195 min.	370 min.

\*Charging time depends on battery capacity, condition, age, temperature and efficiency of charger

**IMPORTANT INFORMATION** Do not open or remove caps or covers. Adding or checking the level of electrolyte is not necessary.

Always use two wrenches for the terminal screws.

**CAUTION!** Lead-acid batteries generate explosive gases. Keep sparks, flame and smoking materials away from batteries.

## MAINTENANCE

### Battery Removal

Corrosion and dirt on the battery and terminals can cause the battery to lose power.

1. Lower the operator cushion to access the battery.
2. Remove the knob from the battery bracket and remove the bracket from the battery.

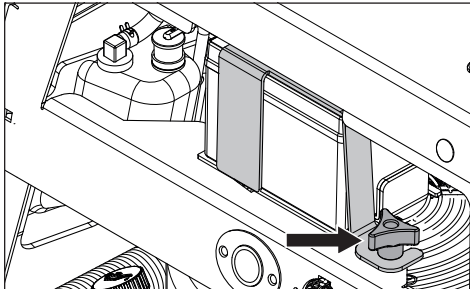

3. Using two wrenches, disconnect the BLACK battery cable then the RED battery cable.
4. Carefully remove the battery from the mower.

### Cleaning

5. Rinse the battery with plain water and dry.
6. Clean the terminals and battery cable ends with a wire brush.

### Replacing

7. Install the new battery with terminals in the same position as the old battery.
8. Connect RED battery cable first to positive (+) battery terminal.
9. Connect BLACK grounding cable to negative (-) battery terminal.
10. Fasten the battery in place with bracket removed in Step 2.

**IMPORTANT INFORMATION** The mower is equipped with a 12-volt negative grounded system. The other vehicle must also be a 12-volt negative grounded system. Do not use your mower to start other vehicles.



**CAUTION!** Always wear eye protection when around batteries.

### V-belts

Check every 100 hours of operation. Check for severe cracking and large nicks.

*NOTE: The belt will show some small cracks in normal operation.*

### Deck Drive Belt

Park the mower on a level surface and engage the park brake. Lower the deck into the lowest cutting position.

1. Slide the tensioner block-pulley assembly toward the left hand side of the frame to release the tension on the belt.

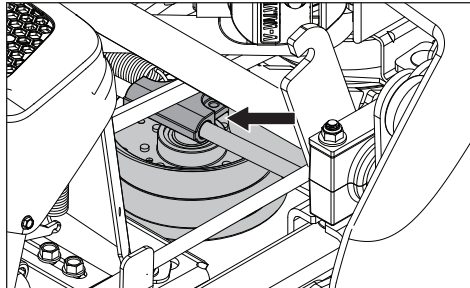

2. Remove the belt from around the clutch and the deck's front stacked pulley.

### Deck Drive Belt Installation

1. Install the belt onto the stacked pulley and the clutch.
2. Tighten the eyebolt for belt tension of 18.2–22.6 kg (40–50 lb).
3. Slide the tensioner block-pulley assembly to the right to tighten the tension on the belt.

### Deck Belt

1. Remove the belt shields and deck drive belt.
2. Remove dirt or debris that has accumulated around the cutter housings and the deck surface.
3. With a 3/8" breaker bar and using the square opening in the idler arm, shift the arm counter clockwise to relieve the tension on the belt.

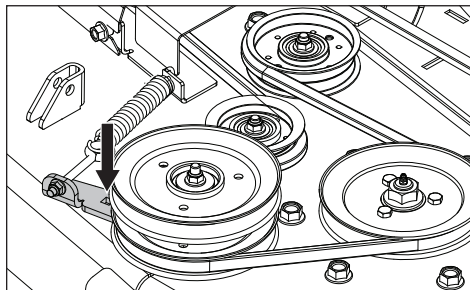

## MAINTENANCE

- Carefully lift the belt over the top of the deck spindle pulleys.
- Remove the belt from the deck stacked pulley.

### Deck Belt Installation

*NOTE: For ease in installing the deck belt, refer to the routing decal on the cutting deck.*

- Place the belt around all the pulleys except the center spindle pulley.
- With a 3/8" breaker bar, shift the idler arm counter clockwise. When there is enough slack, slip the belt onto the center spindle pulley.
- Check belt routing to make sure it matches the routing decal and that the belt does not have twists.
- Adjust belt tension by turning the eyebolt nut until there is approximately 6.4–19.0 mm (1/4"–3/4") of threads showing outside the nut.

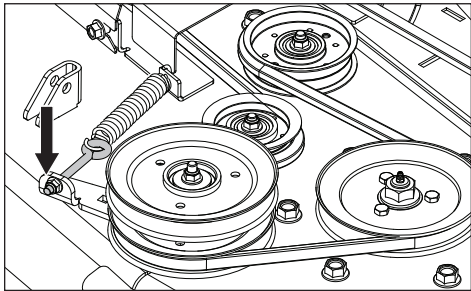

- Belt tension must be set to 13.6–18.1 kg (30–40 lb).
- Replace belt shields on the two spindle housings and secure with fasteners.
- Install the deck drive belt.

### Pump Belt

The belts are not adjustable and need to be replaced if they begin to slip from wear. Park the mower on a level surface. Engage the park brake.

- Remove the deck drive belt.
- Remove clutch stop to access the belt.

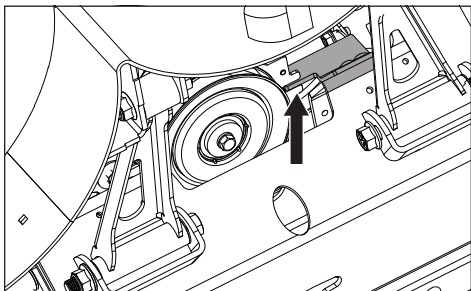

- Disconnect clutch wire.
- Remove belt from the engine and pump pulleys.

### Reinstallation

- Wrap the belt around the engine pulley and then around the left pump pulley.
- Route the belt around the inside of the idler pulley.
- While holding the idler back, wrap the belt around the right pump pulley.
- Replace and secure clutch stop. Reinstall the deck belt.
- Check the belt tension. To tighten the belt, turn the nut on the idler eyebolt. The recommended belt tension is 12.3 kg (27 lb).

### Tire Pressures

All tires must be at 103 kPa / 1 bar / 15 psi.

**IMPORTANT INFORMATION** DO NOT add a tire liner or foam fill material to the tires. Excessive loads created by foam filled tires will cause premature failures.  
Only use O.E.M. specified tires.

### Adjusting the Mower Deck

#### Leveling Deck

Adjust the deck while the mower is on a level surface and raised to transport mode (cutting height of 5"). Make sure the tires are inflated to the correct pressure. See **Tire Pressures** in this section. If tires are under or over inflated, the deck cannot be properly adjusted. Faulty mower deck adjustments will cause an uneven mowing result.

Four bolts control the height and pitch of the mower deck. Adjust the deck slightly higher in the rear.

*NOTE: To insure precision in the leveling procedure, mower deck drive belt must be installed prior to leveling the deck.*

- Wear heavy gloves. Turn the blade tips to align with the deck side to side.

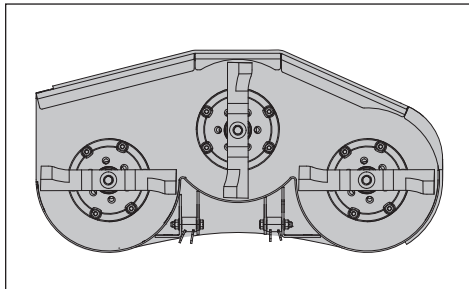

## MAINTENANCE

2. Measure from the floor surface up to the bottom of the blade tip on the discharge side of the mower deck. Record this measurement.
3. Move to the opposite side; check that measurement is the same. If adjustment is required, loosen and adjust the front nuts until the two side to side measurements are equal. Retain measurement.

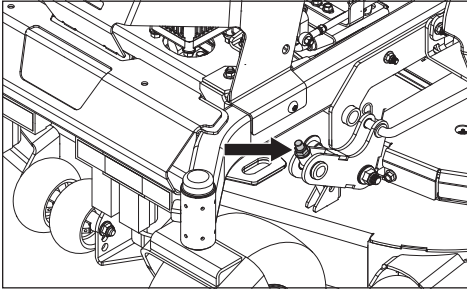

4. Turn the two outer blades to align with the deck front to rear. Reposition the rear mounting nuts up or down until the rear blade tips are positioned 6.4–9.5 mm (1/4"–3/8") higher in the rear than the center blade tips.

Confirm measurements once again. The blade tip height must be 0.0–1.6 mm (0"–1/16") side to side.

In the rear, the blade tips must be 6.4–9.5 mm (1/4"–3/8") higher than the front center measurement. In the front, blade tips must be equal from side to side.

*NOTE: This will place the mower deck in a standard measurement position. Depending on the type of grass being mowed or environmental conditions, more adjustments may be required to get the desired cut.*

### Cutting Blades

To attain the best mowing effect, it is important that blades are well sharpened and not damaged. Replace blades that have been bent or cracked when hitting obstacles.

**CAUTION!** Blades are sharp. Protect your hands with gloves and/or wrap blades with a heavy cloth when handling.

The sharpening of blades should be carried out by an authorized service workshop.



Let the service workshop decide whether a blade with large nicks can be repaired/ground or must be replaced. Balance the blades after sharpening. Check the blade mounts.

### Blade Replacement

1. Remove blade bolt by turning it counter clockwise.
2. Install new or resharpened blade with the stamped part number facing towards the ground/grass (down).
3. Install and tighten blade bolt securely.
4. Torque blade bolt to 122 Nm (90 ft-lb).

**IMPORTANT INFORMATION** Special blade bolt is heat treated. Replace with a Husqvarna bolt if required. Do not use lower grade hardware than specified.

### Anti-scalp Rollers

Anti-scalp rollers keep the deck in the proper position to help prevent scalping in most terrain conditions. Do not adjust the rollers to support the deck.

**IMPORTANT INFORMATION** Adjust anti-scalp rollers with the mower on a flat level surface. To avoid deck damage, the anti-scalp rollers must not be adjusted to support the deck.

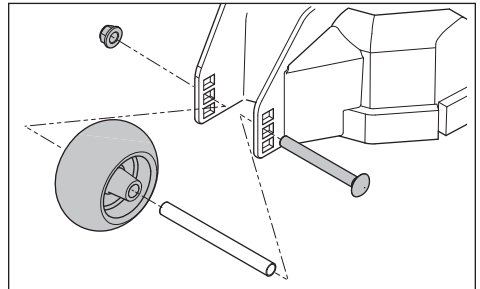

Anti-scalp rollers can be set in three positions.

- Upper: 38 mm to 64 mm (1-1/2" to 2-1/2") grass
- Middle: 64 mm to 102 mm (2-1/2" to 4") grass
- Lower: 102 mm to 127 mm (4" – 5") grass

The rollers must be approximately 6.4 mm (1/4") from the ground. Do not adjust the rollers to support the deck.

### Park Brake

**WARNING!** Faulty adjustment will result in reduced braking and can cause an accident.

Visually check that no damage is found on the brake arms, cables, or park brake mechanism. Check that there is sufficient braking action.

1. If the park brake is not performing correctly, examine the brake arm pivot. With the park brake disengaged, the brake arm pivot bracket should have approximately 3.2 mm (1/8") of play when lifted from the top of the



## MAINTENANCE

brake spring. Adjust the brake spring nut as necessary.

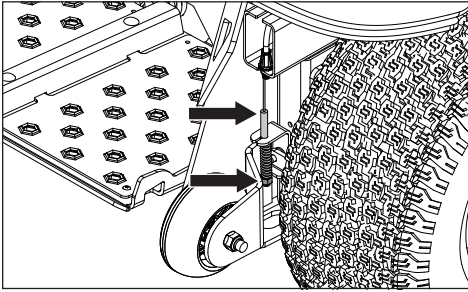

2. If the park brake pivot adjustment is not sufficient, the brake drum may need adjustment. With the rear of the unit supported on jack stands, remove the wheels. Disengage the brake and set the pumps to bypass mode. See **Moving Machine By Hand** in the *Operation* section.
3. Remove the rubber plug from the rear of the brake drum backing plate to access the brake adjuster.

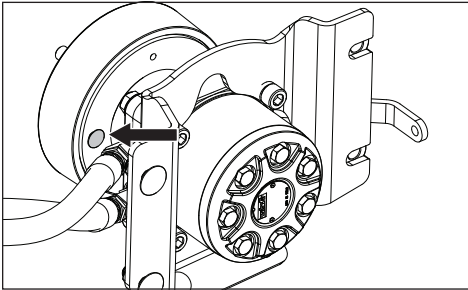

4. Using a brake spoon, turn the brake adjuster towards the front of the unit until the brake begins to engage. The adjuster should then be backed off three clicks.

adjustment. This will require a 3/8" allen key (an extension or a long allen key may be necessary).

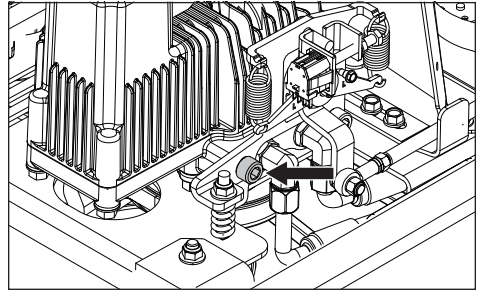

3. Start the unit. When unit is running, engage the OPC lever and release the park brake.
4. Using a 9/16" socket or wrench, adjust the top nut.

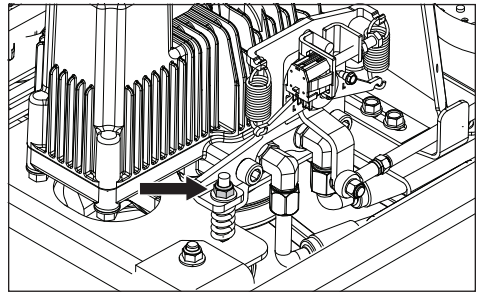

Tighten the nut to bias the unit toward reverse and loosen the nut to bias it forward. During adjustment of the nut, bump the controls into forward and/or reverse and let the controls snap back to neutral. When the wheel is stationary at the same time as the operator controls are in a neutral, tighten the socket cap screws to  $101 \pm 20$  Nm ( $75 \pm 15$  ft-lb). If the wheel continues to move, further adjustment is required.

5. Repeat for the opposite side if necessary.

## Neutral Adjustment

The back wheels must be raised off of the ground (or the unit needs to be put on rollers) and the unit secured so that it cannot roll forwards or backwards during adjustment.

*NOTE: for illustration, the pump covering is not shown. It does not need to be removed for neutral adjustment.*

1. Raise the wheels of the machine and secure the unit so it will not roll forward or back during adjustment.
2. Loosen, but **do not remove** the two socket head cap screws located on the pumps at the front of the unit for the side needing

## MAINTENANCE

### Neutral Switches

1. Make sure the park brake is engaged.
2. With a 1/2" wrench, loosen the jam nuts on each side of the unit.

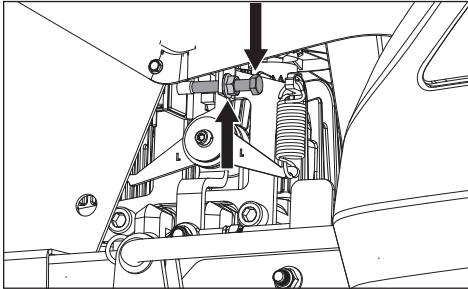

3. Adjust the neutral bolt on the left side of the unit so the plunger on the neutral switch is flush with the surface of the switch.
4. Go to the right side of the unit and back the bolt out so the bolt is not contacting the plunger.

On the right side:

5. Start tightening the right neutral bolt one to or two turns at a time. Between tightening, attempt to start the unit, but be sure to keep fingers or loose articles of clothing away from the pump fans.
6. Continue tightening the neutral bolt until the unit attempts to start (it is not necessary to keep the unit running if it fully starts up).
7. Tighten the neutral bolt an additional half to full turn and then tighten down the jam nut. To prevent bending the bracket, do not over tighten.

On the left side:

8. Loosen the left neutral bolt until it no longer contacts the plunger on the switch.
9. Tighten the bolt one to two turns and attempt to start the unit between each adjustment. When the unit attempts to start, tighten the bolt one half to one full turn and tighten the jam nut.

### Caster Wheels

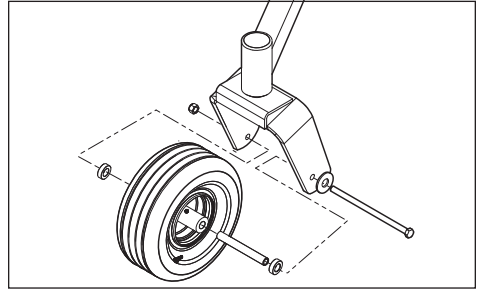

Check every 200 hours. Check that wheels rotate freely.

To replace, remove nut and caster bolt. Pull the wheel out of the fork. Install in reverse order. Tighten caster bolt. Torque to 67.8 Nm (50 ft-lb).

*NOTE: Tire must rotate freely but axle spacers must not. If wheels do not rotate freely take the unit to the dealer for service.*

### Cleaning



**CAUTION!** Always wear eye protection when cleaning or washing the mower.

Regular cleaning and washing, especially under the mower deck, will increase the machine's life-span. Make it a habit to clean the machine directly after use (after it is cooled), before the dirt sticks.

Do not spray water on the top of the mower deck. Use compressed air to clean the top side of mower deck. Regularly clean deck and underside of the deck with normal water pressure. Do not use a high pressure washer or steam cleaner. Avoid spraying engine and electrical components with water.

Do not rinse hot surfaces with cold water. Let unit cool before washing.

# LUBRICATION

## Lubrication Schedule

12/12	1/52	1/365		50h	250h	500h	
				(2x)	(2x)	(2x)	
				(2x)	(2x)	(2x)	
				*			
				(3x)	(3x)	(3x)	
				4			
					*		

12/12	Every year
1/52	Every Week
1/365	Every day

\* Initial hydraulic oil and filter change performed at 1000 hours. See **Qualified Hydraulic Oils** for recommended lubrication schedule.

▲ Change engine oil every 50 hours when operating with a heavy load or at high ambient temperatures.

Lubricate with grease gun	
Filter change	
Oil change	
Level check	

### General

Remove the ignition key to prevent accidental movements during lubrication.

When lubricating with an oil can, it must be filled with engine oil. When lubricating with grease, unless otherwise stated, use high grade molybdenum disulphide grease.

For daily use, the machine must be lubricated twice weekly.

Wipe away excess grease after lubrication. It is important to avoid getting lubricant on the belts or the drive surfaces on the belt pulleys. If this happens, clean them with spirits. If the belt continues to slip after cleaning, it must be replaced. Gasoline or other petroleum products must not be used to clean belts.

### Qualified Hydraulic Oils

If Parker™ HT-1000 oil is used continually, the oil and filters must be changed every 1000 hours.

If the following oils are used:

Castrol™ Syntec 5W-50

Amsoil™ AW ISO 68

Shell™ TTF-SB

then oil and filters must be changed every 500 hours after the initial 1000 hour oil and filter change.

If a premium grade synthetic engine oil with a minimum viscosity grade of 15W40 is used then oil and filters must be changed every 250 hours after the initial 1000 hour oil and filter change.

# LUBRICATION

## Engine Oil

*NOTE: Change the engine oil when the engine is warm. Refer to the engine owner's manual for the correct replacement oil and filter change recommendations.*

**⚠ WARNING!** The engine drain plug is located close to the muffler. To prevent burns, the engine should be shut off and allowed to cool slightly so the engine is still warm but the surrounding surfaces and oil are not.

1. Park on a level surface. Engage the park brake.
2. Clean the dirt and debris from the area around the oil fill cap.
3. Remove the cap/dipstick.
4. Lower or remove the operator cushion to access the drain hose at the left rear of the engine.

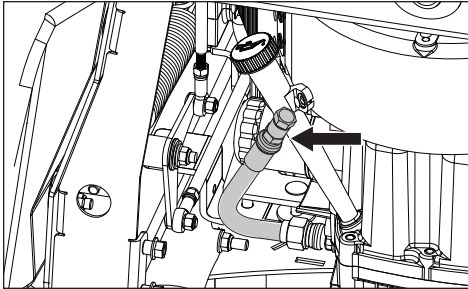

5. Route the drain hose down through the hole in the frame.
6. Put an adequately sized container under the end of the drain hose and remove the oil drain plug.
7. Let the oil fully drain from the engine.
8. Replace the drain hose plug and tighten securely.
9. Fill the engine with new oil as recommended by the engine manufacturer (see the Engine Manual).
10. Remove the hose from the frame and secure it into the original position.
11. Check the level with the dipstick.
12. Replace the oil fill cap securely when the oil level is FULL.
13. Refer to the Service Journal for oil checking and changing intervals.

## Wheels and Blades

Use only good quality bearing grease. Grease from well-known brand names (petrochemical companies, etc.) usually maintains a good quality.

### Front Wheel Mount

Remove dust cap to expose zerk. Lubricate with a grease gun until the grease is forced out around the top washer.

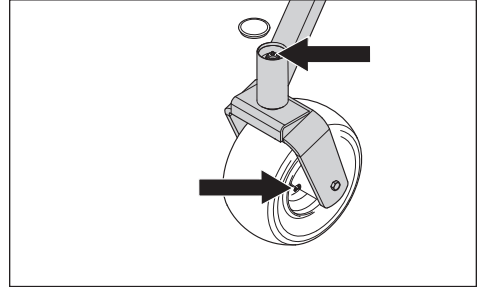

### Front Wheel Bearings

Lubricate 3–4 strokes with a grease gun on each set of wheel bearings.

### Deck Spindles

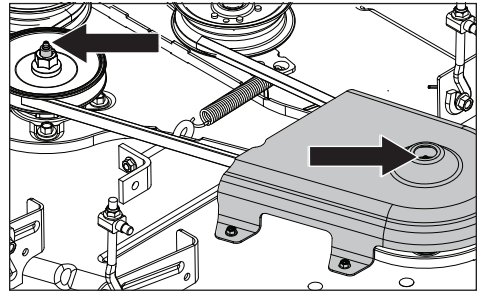

1. Lower the cutting deck completely.
2. A grease gun with a rubber hose must be used to access the center spindle.
3. Lubricate with a grease gun, 2–3 strokes per spindle.

# LUBRICATION

## Transaxle Fluid Change

### Hydraulic Oil Level Check

Check the oil level in the hydraulic tanks daily before using the mower. The oil level should be between the markings on the dipstick. This is the appropriate level when COLD.

Check all connections, hoses, and tubes for damage or leaks. Contact an authorized service workshop if repair or replacement is needed.

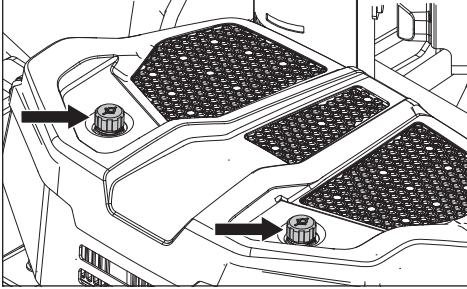

### Oil and Filters Change

The hydraulic oil and filters must be replaced every 250 to 1000 hours or once per year, depending on the type of oil used. See **Qualified Hydraulic Oils** in the *Lubrication* section for a list of approved oils or refer to the transmission manufacturers service manual.

Due to the risk of impurities entering the system, all transmission work should be performed by an authorized service workshop.

**⚠ WARNING!** Escaping hydraulic oil under pressure can have sufficient force to penetrate the skin, causing serious injury. If injured by escaping fluid, see a doctor at once. Serious infection or reaction can develop if proper medical treatment is not administered immediately.

**IMPORTANT INFORMATION** Use minimal lubrication and remove excess lubricant so that it does not come into contact with belts or belt pulley drive surfaces.

# TROUBLESHOOTING

## Problem / Cause

### Engine will not start

- Blade switch is engaged
- Steering controls are not locked in the neutral position
- Dead battery
- Contamination in the carburetor or fuel line
- Clogged fuel filter or fuel line
- Ignition system faulty
- Neutral out of adjustment

### Starter does not turn the engine over

- Dead battery
- Battery terminal cable contacts are defective
- Neutral out of adjustment
- Blown fuse
- Fault in the starter safety circuit. See **Safety System** in the *Maintenance* Section

### Engine runs rough

- Faulty carburetor
- Clogged fuel filter or jet
- Neutral out of adjustment
- Choke is engaged with a warm engine
- Clogged ventilation valve on the fuel cap
- Fuel tank nearly empty
- Fouled spark plugs
- Rich fuel mixture or fuel-air mixture.
- Clogged fuel filter
- Wrong fuel type
- Water in fuel

### Engine seems weak

- Clogged fuel filter
- Neutral out of adjustment
- Fouled spark plugs
- Carburetor incorrectly adjusted

### Machine vibrates

- Blades are loose
- Blades are incorrectly balanced
- Engine is loose

### Engine overheats

- Clogged air cleaner
- Engine overloaded
- Poor ventilation around engine
- Defective engine speed regulator
- Too little or no oil in the engine
- Contamination in the fuel line
- Fouled spark plugs

### Battery not charging

- Battery terminal cable contacts are defective
- Charging lead is disconnected
- Fault in engine charging system

### Mower moves slowly, unevenly, or not at all

- Park brake is engaged
- Bypass lever on pump is engaged
- Transmission drive belt is slack or off
- Air trapped in hydraulic system

### Mower deck not engaging

- Drive belt for the mower deck is loose
- Electromagnetic coupling contact is loose
- Blade switch is faulty or loose from cable contact
- Blown fuse

### Transaxle leaks oil

- Damaged seals, housing, or gaskets
- Air trapped in hydraulic system

### Uneven mowing results

- Unequal air pressures in tires
- Bent blades
- Suspension for the mower deck is uneven
- Blades are dull
- Driving speed too high
- Grass is too long
- Grass has collected under the mower deck

## STORAGE

### Winter Storage

The machine must be readied for storage at the end of the mowing season, or if it will not be in use for more than thirty days.

Fuel allowed to stand for long periods of time (thirty days or more) can leave sticky residues that can plug the carburetor and disrupt engine function.

Fuel stabilizers are an permitted option as regards to the sticky residues that can occur during storage.

Add stabilizer to the fuel in the tank or in the storage container. Always use the mixing ratios specified by the manufacturer of the stabilizer.

Run the engine for at least ten minutes after adding the stabilizer so that it reaches the carburetor. Do not empty the fuel tank and the carburetor if a stabilizer has been added.



**WARNING!** Do not store an engine with fuel in the tank indoors or in poorly ventilated spaces where fuel vapor can come in contact with open flames, sparks, or a pilot light such as in a boiler, hot water tank, clothes dryer, etc. Handle the fuel with care. It is very flammable and can cause serious personal injury and property damage. Drain the fuel into an approved container outdoors and store far away from open flame or sources of ignition. Do not use gasoline for cleaning. Use a degreaser and warm water.

### To ready the machine for storage:

1. Thoroughly clean the machine, especially under the mower deck. Touch up damage to the paint and spray a thin layer of oil on the underside of the mower deck to avoid corrosion.
2. Inspect the machine for worn or damaged parts and tighten nuts or screws that may have become loose.
3. Change the engine oil; dispose of properly.
4. Empty the fuel tanks or add a fuel stabilizer. Start the engine and let it run until the carburetor is drained of fuel or the stabilizer has reached the carburetor.
5. Remove the spark plug and pour about a tablespoon of engine oil into the cylinder. Turn over the engine so that the oil is evenly distributed and then refit the spark plug.
6. Lubricate all grease zerks, joints, and axles.
7. Remove the battery. Clean, charge, and store the battery in a cool place, but protect it from direct cold.
8. Store the machine in a clean, dry place and cover it for extra protection.

### Service

When ordering spare parts, please specify the purchase year, model, type, and serial number.

Always use genuine Husqvarna spare parts.

An annual check-up at an authorized service workshop is a good way to ensure that the machine performs its best the following season.

# SCHEMATIC

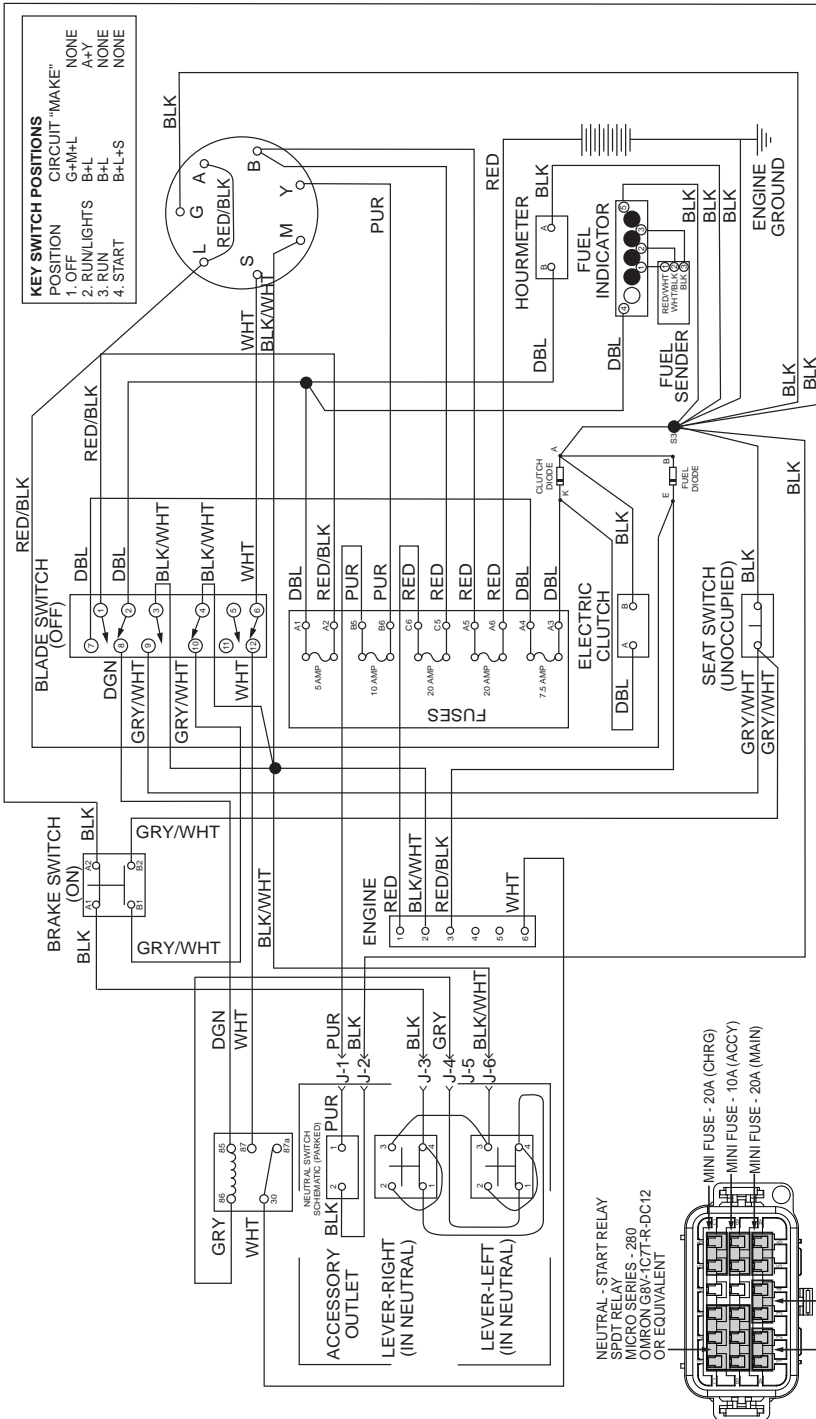



## TECHNICAL DATA

ENGINE		
Manufacturer	Kawasaki	
Type	FX751V	
Power	18.3 kW <sup>1)</sup>	24.5 hp <sup>1)</sup>
Lubrication	Pressure with oil filter	
Fuel	Min 87 octane unleaded (Max ethanol 10%, Max MTBE 15%)	
Fuel tank capacity	24.6 litres	6-1/2 gallons
Cooling	Air cooled	
Air filter	Heavy duty canister	
Alternator	12v 15 amp @ 3600 rpm	
Starter	Electric	
TRANSMISSION		
Transmission	Parker™ 12cc	
Steering control	Dual levers, foam gripped	
Speed forward	0–15.3 km/h	0–9.5 mph
Speed reverse	0–8.0 km/h	0–5.0 mph
Brakes	Mechanical Park Brake	
Front caster tires	13 x 6.5	
Rear tires, turf pneumatic	20 x 10-10	
Tire pressure	103 kPa / 1 bar / 15 psi	
FRAME		
Cutting Width	137 cm	54"
Cutting Height	3.8 cm – 12.7 cm	1-1/2" – 5"
Number of Blades	3	
Blade Length	47 cm	18-1/2"
Anti-scalp roller	2 adjustable	
Service Meter	Digital	
Blade Engagement	Ogura GT 2.75 Clutch	
Deck Construction	7 gauge fabricated	
Productivity	16, 592 m <sup>2</sup> /h	4.1 acres/h
DIMENSIONS		
Weight	533 kg	1,176 lb
Base Machine Length	145 cm	57"
Base Machine Height	145 cm	57"
Base Machine Width	120 cm	47"
Overall Width, Chute Up	140 cm	55"
Overall Width, Chute Down	173 cm	68"

<sup>1)</sup> The power rating as declared by the engine manufacturer is the average gross power output at the specified RPM of a typical production engine for the engine model measured using SAE Standards for engine gross power. Refer to the engine manufacturer engine specifications.

# TECHNICAL DATA

## Torque Specifications

Engine crankshaft bolt	50 ft-lb	Standard 1/4" fasteners	9 ft-lb
Deck pulley bolts	150 ft-lb	Standard 5/16" fasteners	18 ft-lb
Lug nuts	75 ft-lb	Standard 3/8" fasteners	33 ft-lb
Blade bolt	90 ft-lb	Standard 7/16" fasteners	52 ft-lb
		Standard 1/2" fasteners	80 ft-lb

## HEX HEAD CAP SCREWS

The torque values shown must be used as a general guideline when specific torque values are not given.

## U.S. Standard Hardware

	Grade	SAE Grade 5		SAE Grade 8		Flangelock Screw w/Flangelock Nut	
	Size	ft-lb	Nm	ft-lb	Nm	ft-lb	Nm
Shank Size (Diameter in inches, fine or coarse thread)	1/4	9	12	13	18		
	5/16	18	24	28	38	24	33
	3/8	31	42	46	62	40	54
	7/16	50	68	75	102		
	1/2	75	102	115	156		
	9/16	110	149	165	224		
	5/8	150	203	225	305		
	3/4	250	339	370	502		
	7/8	378	512	591	801		
	1-1/8	782	1060	1410	1912		

\*\* Grade 5 - Minimum commercial quality (lower quality not recommended)

## Metric Standard Hardware

	Grade	Grade 8.8		Grade 10.9		Grade 12.9	
	Size	ft-lb	Nm	ft-lb	Nm	ft-lb	Nm
Shank Size (Diameter in millimeters, fine or coarse thread)	M4	1.5	2	2.2	3	2.7	3.7
	M5	3	4	4.5	6	5.2	7
	M6	5.2	7	7.5	10	8.2	11
	M7	8.2	11	12	16	15	20
	M8	13.5	18	18.8	25	21.8	30
	M10	24	33	35.2	48	43.5	59
	M12	43.5	59	62.2	84	75	102
	M14	70.5	96	100	136	119	161
	M16	108	146	147	199	176	239
	M18	142	193	202	274	242	328
	M20	195	264	275	373	330	447
	M22	276	374	390	529	471	639
	M24	353	478	498	675	596	808
M27	530	719	735	996	904	1226	

# SERVICE JOURNAL

## DELIVERY SERVICE

Action	Date, mtr reading, stamp, sign
Charge and connect the battery	<input type="checkbox"/>
Adjust the tire pressure of all wheels to 103 kPa (15 psi)	<input type="checkbox"/>
Check that the right amount of oil is in the engine	<input type="checkbox"/>
Adjust the position of the steering controls	<input type="checkbox"/>
Fill with fuel	<input type="checkbox"/>
Start the engine	<input type="checkbox"/>
Check that there is drive to the two wheels	<input type="checkbox"/>
Check mower deck pitch and adjustment	<input type="checkbox"/>
Check hydraulic oil level	<input type="checkbox"/>
Check:	
Safety switch for the park brake	<input type="checkbox"/>
Safety switch for the mower deck	<input type="checkbox"/>
Safety switch in the steering controls	<input type="checkbox"/>
Park brake functionality and adjustment	<input type="checkbox"/>
Driving forward	<input type="checkbox"/>
Driving backward	<input type="checkbox"/>
Engaging the blades	<input type="checkbox"/>
Idle speed	<input type="checkbox"/>
Engine high idle speed	<input type="checkbox"/>
Inform the customer about:	
Need and advantages of following the service schedule	<input type="checkbox"/>
Need and advantages of leaving the machine for service	<input type="checkbox"/>
Effects of service and maintaining a service journal on the machine's resale value	<input type="checkbox"/>
Application areas for mulching	<input type="checkbox"/>
Fill in the sales papers, etc.	

Delivery service has  
been carried out

No remaining notes

Certified:

# SERVICE JOURNAL

## AFTER 10 HOURS

Action	Date, mtr reading, stamp, sign
Change the engine oil	<input type="checkbox"/>
Inspect hydraulic hoses	<input type="checkbox"/>
Inspect hydraulic belt	<input type="checkbox"/>
Inspect hydraulic filter	<input type="checkbox"/>
Check neutral position	<input type="checkbox"/>
Check safety system	<input type="checkbox"/>
Check fuel system for leaks	<input type="checkbox"/>
Inspect safety guards and shields	<input type="checkbox"/>
Check brake adjustment	<input type="checkbox"/>
Check hydraulic oil level	<input type="checkbox"/>

## DAILY SERVICE

Action	Date, mtr reading, stamp, sign
Clean debris from mower	<input type="checkbox"/>
Check engine oil level	<input type="checkbox"/>
Check the tire pressures	<input type="checkbox"/>
Check underside of deck	<input type="checkbox"/>
Inspect deck pulleys	<input type="checkbox"/>
Check/clean the engine's cooling air intake	<input type="checkbox"/>
Check safety system	<input type="checkbox"/>
Check fuel system for leaks	<input type="checkbox"/>
Inspect safety guards and shields	<input type="checkbox"/>
Check brake adjustment	<input type="checkbox"/>
Check hydraulic oil level	<input type="checkbox"/>

# SERVICE JOURNAL

## 50-HOUR SERVICE

Action	Date, mtr reading, stamp, sign
Clean debris from mower	<input type="checkbox"/>
Change the engine oil and filter	<input type="checkbox"/>
Check the tire pressures	<input type="checkbox"/>
Check underside of deck	<input type="checkbox"/>
Inspect deck pulleys	<input type="checkbox"/>
Check/clean the engine's cooling air intake	<input type="checkbox"/>
Check safety system	<input type="checkbox"/>
Check fuel system for leaks	<input type="checkbox"/>
Inspect safety guards and shields	<input type="checkbox"/>
Check brake adjustment	<input type="checkbox"/>
Check hydraulic oil level	<input type="checkbox"/>

# SERVICE JOURNAL

## 250-HOUR SERVICE

Action	Date, mtr reading, stamp, sign
Grease fittings (caster pivots and caster wheels)	<input type="checkbox"/>
Inspect frame	<input type="checkbox"/>
Inspect throttle and choke cables	<input type="checkbox"/>
Inspect hardware	<input type="checkbox"/>
Check the tire pressures	<input type="checkbox"/>
Change the engine oil and filter	<input type="checkbox"/>
Change air filter	<input type="checkbox"/>
Inspect spark plug	<input type="checkbox"/>
Inspect fuel filter	<input type="checkbox"/>
Check engine RPM	<input type="checkbox"/>
Clean underside of deck	<input type="checkbox"/>
Check blade pitch	<input type="checkbox"/>
Grease blade spindles	<input type="checkbox"/>
Inspect spindle bearings	<input type="checkbox"/>
Inspect deck belt and blades	<input type="checkbox"/>
Inspect idler arm bearings	<input type="checkbox"/>
Inspect deck idler pulleys	<input type="checkbox"/>
Inspect hydraulic filter	<input type="checkbox"/>
Inspect hydraulic drive belt	<input type="checkbox"/>
Inspect hydraulic hoses	<input type="checkbox"/>
Check neutral position	<input type="checkbox"/>
Inspect battery connections	<input type="checkbox"/>
Check safety system	<input type="checkbox"/>
Check fuel system for leaks	<input type="checkbox"/>
Inspect safety guards and shields	<input type="checkbox"/>
Check brake adjustment	<input type="checkbox"/>
Change hydraulic oil and filter	<input type="checkbox"/>

# SERVICE JOURNAL

## 500-HOUR SERVICE

Action	Date, mtr reading, stamp, sign
Grease fittings (caster pivots and caster wheels)	<input type="checkbox"/>
Inspect frame	<input type="checkbox"/>
Inspect throttle and choke cables	<input type="checkbox"/>
Inspect hardware	<input type="checkbox"/>
Check the tire pressures	<input type="checkbox"/>
Change the engine oil and filter	<input type="checkbox"/>
Change air filter	<input type="checkbox"/>
Inspect spark plug	<input type="checkbox"/>
Inspect fuel filter	<input type="checkbox"/>
Check engine RPM	<input type="checkbox"/>
Clean underside of deck	<input type="checkbox"/>
Check blade pitch	<input type="checkbox"/>
Grease blade spindles	<input type="checkbox"/>
Inspect spindle bearings	<input type="checkbox"/>
Inspect deck belt and blades	<input type="checkbox"/>
Inspect idler arm bearings	<input type="checkbox"/>
Inspect deck idler pulleys	<input type="checkbox"/>
Change hydraulic oil and filter	<input type="checkbox"/>
Replace hydraulic drive belt	<input type="checkbox"/>
Inspect hydraulic hoses	<input type="checkbox"/>
Check neutral position	<input type="checkbox"/>
Inspect battery connections	<input type="checkbox"/>
Load test battery	<input type="checkbox"/>
Clean electrical connections	<input type="checkbox"/>
Inspect the clutch	<input type="checkbox"/>
Check safety system	<input type="checkbox"/>
Check fuel system for leaks	<input type="checkbox"/>
Inspect safety guards and shields	<input type="checkbox"/>
Check brake adjustment	<input type="checkbox"/>

# SERVICE JOURNAL

AT LEAST ONCE EACH YEAR

Action	Date, mtr reading, stamp, sign
Clean the engine's cooling air intake	<input type="checkbox"/>
Replace the air cleaner's foam pre-filter	<input type="checkbox"/>
Replace the air filter's paper cartridge	<input type="checkbox"/>
Change the engine oil	<input type="checkbox"/>
Replace the engine oil filter	<input type="checkbox"/>
Change the hydraulic oil and filter	<input type="checkbox"/>
Check/adjust the cutting height	<input type="checkbox"/>
Check/adjust the park brake	<input type="checkbox"/>
Clean/change the spark plugs	<input type="checkbox"/>
Inspect spark plug	<input type="checkbox"/>
Check the engine valve clearance	<input type="checkbox"/>











[www.husqvarna.com](http://www.husqvarna.com)

2018-05-01