



 **Husqvarna**[®]



330i, 535i XP

Contents

Introduction.....	2	Troubleshooting.....	31
Safety.....	4	Transportation, storage and disposal.....	32
Assembly.....	12	Technical data.....	33
Operation.....	14	Accessories.....	34
Maintenance.....	23	Warranty.....	36

Introduction

Intended use

This product is for forest service such as felling, limbing and cutting.

Note: National regulations can restrict the use of the product.

Product description

Husqvarna 330i, 535i XP are chainsaw models with an electrical motor.

Work is constantly in progress to increase your safety and efficiency during operation. Speak to your servicing dealer for more information.

Product overview

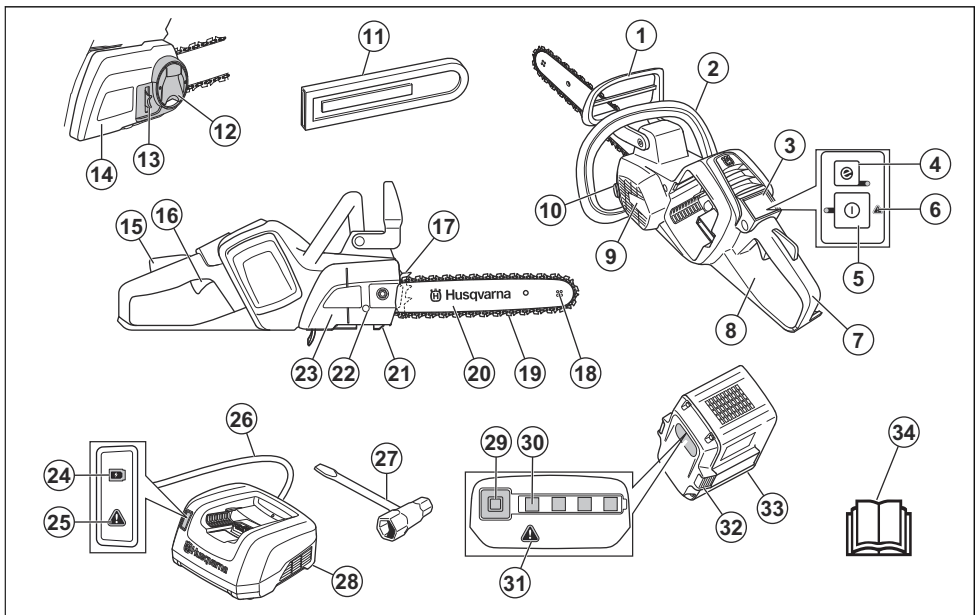

- | | |
|--------------------------------------|----------------------------------|
| 1. Front hand guard | 9. Fan housing |
| 2. Front handle | 10. Chain oil tank |
| 3. Keypad | 11. Guide bar cover |
| 4. SavE button | 12. Knob (330i) |
| 5. Warning indicator | 13. Chain tensioner wheel (330i) |
| 6. Start and stop button | 14. Drive sprocket cover (330i) |
| 7. Rear handle with right hand guard | 15. Power trigger lockout |
| 8. Information and warning decal | 16. Power trigger |
| | 17. Chain bar |
| | 18. Chain sprocket |
| | 19. Chain sprocket nut |
| | 20. Chain sprocket washer |
| | 21. Chain sprocket lock |
| | 22. Chain sprocket lock nut |
| | 23. Chain sprocket lock washer |
| | 24. Keypad cover |
| | 25. Keypad |
| | 26. Keypad button |
| | 27. Keypad screw |
| | 28. Keypad cover screw |
| | 29. Keypad cover |
| | 30. Keypad button |
| | 31. Keypad cover screw |
| | 32. Keypad cover |
| | 33. Keypad button |
| | 34. User manual |

17. Spiked bumper
18. Bar tip sprocket
19. Saw chain
20. Guide bar
21. Chain catcher
22. Chain tensioning screw
23. Drive sprocket cover (535i XP)
24. Charging LED
25. Warning indicator
26. Power cord
27. Combination wrench
28. Battery charger
29. Button, battery status
30. Battery status
31. Warning indicator
32. Battery release button
33. Battery
34. Operator's manual

Symbols on the product



Risk of serious injury or death to the operator or others. Be careful and use the product correctly. Read the operator's manual carefully and understand the instructions before operation of the product.



Wear approved protective helmet, hearing and eye protection.



Use both hands when you operate the product.



Never operate the product holding it with one hand.



Never let the guide bar tip touch an object.



Warning! Kickback can occur when the guide bar tip touches an object. This causes the guide bar to be thrown in the direction of the operator. Risk of serious injury or death.



Chain brake, engaged (right). Chain brake, disengaged (left).



Chain oil fill.



Direct current.

IPX4 Protected against splashing water.



Recommended cutting equipment in this example: Bar length 14 inches (356 mm), max. nose radius 9 Teeth, chain type Husqvarna H38.



Measured maximum kickback value without triggering the brake, for the bar and chain combination on the label.



Measured maximum kickback value with brake for the bar and chain combination on the label.

yyyyywwxxxxx

The rating plate shows serial number. **yyyyy** is the production year, **ww** is the production week.

Note: Other symbols/decals on the product refer to certification requirements for certain markets.

Symbols on the battery and/or on the battery charger

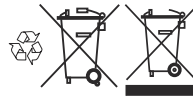

Recycle this product at a recycling station for electrical and electronic equipment. (Applies to Europe only)



Fail-safe transformer.



Use and keep the battery charger indoors only.



Double insulation.

Proposition 65



WARNING

This product contains or emits a chemical known to the State of California to cause cancer or birth defects or other reproductive harm.

Safety

Safety definitions

The definitions below give the level of severity for each signal word.



WARNING: Injury to persons.



CAUTION: Damage to the product.

Note: This information makes the product easier to use.

General power tool safety warnings



WARNING: Read all safety warnings and all instructions. Failure to follow the warnings and instructions may result in electric shock, fire and/or serious injury.

Note: Save all warnings and instructions for future reference. The term "power tool" in the warnings refers to your mains-operated (corded) power tool or battery-operated (cordless) power tool.

Work area safety

- **Keep work area clean and well lit.** Cluttered or dark areas invite accidents.
- **Do not operate power tools in explosive atmospheres, such as in the presence of flammable liquids, gases or dust.** Power tools create sparks which may ignite the dust or fumes.
- **Keep children and bystanders away while operating a power tool.** Distractions can cause you to lose control.

Electrical safety

- **Power tool plugs must match the outlet. Never modify the plug in any way. Do not use any adapter plugs with earthed (grounded) power tools.** Unmodified plugs and matching outlets will reduce risk of electric shock.

- **Avoid body contact with earthed or grounded surfaces, such as pipes, radiators, ranges and refrigerators.** There is an increased risk of electric shock if your body is earthed or grounded.
- **Do not expose power tools to rain or wet conditions.** Water entering a power tool will increase the risk of electric shock.
- **Do not abuse the cord. Never use the cord for carrying, pulling or unplugging the power tool. Keep cord away from heat, oil, sharp edges or moving parts.** Damaged or entangled cords increase the risk of electric shock.
- **When operating a power tool outdoors, use an extension cord suitable for outdoor use.** Use of a cord suitable for outdoor use reduces the risk of electric shock.
- **If operating a power tool in a damp location is unavoidable, use a ground fault circuit interrupter (GFCI) protected supply.** Use of a GFCI reduces the risk of electric shock.

Personal safety

- **Stay alert, monitor what you are doing and use common sense when operating a power tool. Do not use a power tool while you are tired or under the influence of drugs, alcohol or medication.** A moment of inattention while operating power tools may result in serious personal injury.
- **Use personal protective equipment. Always wear eye protection.** Protective equipment such as dust mask, non-skid safety shoes, hard hat, or hearing protection used for appropriate conditions will reduce personal injuries.
- **Prevent unintentional starting. Ensure the switch is in the OFF-position before connecting to a power source and/or battery pack, picking up or carrying the tool.** Carrying power tools with your finger on the switch or energising power tools that have the switch on invites accidents.
- **Remove any adjusting key or wrench before turning the power tool on.** A wrench or a key left attached to a rotating part of the power tool may result in personal injury.
- **Do not overreach. Keep proper footing and balance at all times.** This enables better control of the power tool in unexpected situations.

- **Dress properly. Do not wear loose clothing or jewellery. Keep your hair, clothing and gloves away from moving parts.** Loose clothes, jewellery or long hair can be caught in moving parts.
- **If devices are provided for the connection of dust extraction and collection facilities, ensure these are connected and properly used.** Use of dust collection can reduce dust-related hazards.
- The vibration emission during actual use of the power tool can differ from the declared total value depending on the ways in which the tool is used. Operators should identify safety measures to protect themselves that are based on an estimation of exposure in the actual conditions of use (taking account of all parts of the operating cycle such as the times when the tool is switched off and when it is running idle in addition to the trigger).
- **Use power tools only with specifically designated battery packs.** Use of any other battery packs may create a risk of injury and fire.
- **When battery pack is not in use, keep it away from other metal objects, like paper clips, coins, keys, nails, screws or other small metal objects, that can make a connection from one terminal to another.** Shorting the battery terminals together may cause burns or a fire.
- **Under abusive conditions, liquid may be ejected from the battery; avoid contact. If contact accidentally occurs, flush with water. If liquid contacts eyes, additionally seek medical help.** Liquid ejected from the battery may cause irritations or burns.

Power tool use and care

- **Do not force the power tool. Use the correct power tool for your application.** The correct power tool will do the job better and safer at the rate for which it was designed.
- **Do not use the power tool if the switch does not turn it on and off.** Any power tool that cannot be controlled with the switch is dangerous and must be repaired.
- **Disconnect the plug from the power source and/or the battery pack from the power tool before making any adjustments, changing accessories, or storing power tools.** Such preventive safety measures reduce the risk of starting the power tool accidentally.
- **Store idle power tools out of the reach of children and do not allow persons unfamiliar with the power tool or these instructions to operate the power tool.** Power tools are dangerous in the hands of untrained users.
- **Maintain power tools. Check for misalignment or binding of moving parts, breakage of parts and any other condition that may affect the power tool's operation. If damaged, have the power tool repaired before use.** Many accidents are caused by poorly maintained power tools.
- **Keep cutting tools sharp and clean.** Properly maintained cutting tools with sharp cutting edges are less likely to bind and are easier to control.
- **Use the power tool, accessories and tool bits etc. in accordance with these instructions, taking into account the working conditions and the work to be performed.** Use of the power tool for operations different from those intended could result in a hazardous situation.

Battery tool use and care

- **Recharge only with the charger specified by the manufacturer.** A charger that is suitable for one type of battery pack may create a risk of fire when used with another battery pack.

Service

- **Have your power tool serviced by a qualified repair person using only identical replacement parts.** This will ensure that the safety of the power tool is maintained.

Chain saw safety warnings

- **Keep all parts of the body away from the saw chain when the chain saw is operating. Before you start the chain saw, make sure the saw chain is not contacting anything.** A moment of inattention while operating chain saws may cause entanglement of you clothing or body with the saw chain.
- **Always hold the chain saw with your right hand on the rear handle and your left hand on the front handle.** Holding the chain saw with a reversed hand configuration increases the risk of personal injury and should never be done.
- **Hold the power tool by insulated gripping surface only, because the saw chain may contact hidden wiring or its own cord.** Saw chain contacting a "live" wire may make exposed metal parts of the power tool "live" and could give the operator an electric shock.
- **Wear safety glasses and hearing protection. Further protective equipment for head, hands, legs and feet is recommended.** Adequate protective clothing will reduce personal injury by flying debris or accidental contact with the saw chain.
- **Do not operate a chain saw in a tree.** Operation of chain saw while up a tree may result in personal injury.
- **Always keep proper footing and operate the chain saw only when standing on fixed, secure and level surface.** Slippery or unstable surfaces such as ladders may cause a loss of balance or control of the chain saw.
- **When cutting a limb that is under tension be alert for spring back.** When the tension in the wood fibres is released the spring loaded limb may strike the operator and/or throw the chain saw out of control.

- **Use extreme caution when cutting brush and saplings.** The slender material may catch the saw chain and be whipped forward toward you or pull you off balance.
- **Carry the chain saw by the front handle with the chain saw switched off and away from your body. When transporting or storing the chain saw always fit the guide bar cover.** Proper handling of the chain saw will reduce the likelihood of accidental contact with the moving saw chain.
- **Follow instruction for lubricating, chain tensioning and changing accessories.** Improperly tensioned or lubricated saw chain may either brake or increase the chance of kickback.
- **Keep handles dry, clean and free from oil and grease.** Greasy, oily handles are slippery causing loss of control.
- **Cut wood only. Do not use chain saw for purposes not intended. For example: do not use chain saw for cutting plastic, masonry or nonwood building materials.** Use of the chain saw for operations different than intended could result in a hazardous situation.
- We strongly recommend that first time users practice sawing logs on a saw horse or cradle.

- **Follow the manufacturer's sharpening and maintenance instructions for the saw chain.** Decreasing the depth gauge height can lead to increased kickback.

SAVE THESE INSTRUCTIONS.

General safety instructions



WARNING: Read the warning instructions that follow before you use the product.

- This product is a dangerous tool if you are not careful or if you use the product incorrectly. This product can cause serious injury or death to the operator or others. It is very important that you read and understand the contents of this operator's manual.
- Do not change the product without an approval from the manufacturer. Do not use a product that has been changed by others and always use original accessories. Changes that are not approved from the manufacturer can result in serious injury or death to the operator or others. Your warranty may not cover damage or liability caused by the use of non-authorized accessories or replacement parts.
- Long term inhalation of chain oil fumes and sawdust can cause health problems.
- This product produces an electromagnetic field during operation. This field may under some circumstances interfere with active or passive medical implants. To decrease the risk of serious injury or death, we recommend persons with medical implants to turn to their physician and the medical implant manufacturer before operating this product.
- The information in this operator's manual is not a replacement for professional knowledge and experience. If you do not feel safe in the situation that you are in, stop the product. Turn to your servicing dealer or a professional chainsaw operator. Do not attempt any task that you feel unsure of!

Causes and operator prevention of kickback

Kickback may occur when the nose or tip of the guide bar touches an object, or when the wood closes in and pinches the saw chain in the cut. Tip contact in some cases may cause a sudden reverse reaction, kicking the guide bar up and back towards the operator. Pinching the saw chain along the top of the guide bar may push the guide bar rapidly back towards the operator. Either of these reactions may cause you to lose control of the saw which could result in serious personal injury. Do not rely exclusively upon the safety devices built into your saw. As a chain saw user, you should take several steps to keep your cutting jobs free from accident or injury. Kickback is a result of tool misuse and/or incorrect operating procedures or conditions and can be avoided by taking proper precautions as given below:

- **Maintain a firm grip, with thumbs and fingers encircling the chain saw handles, with both hands on the saw and position your body and arm to allow you to resist kickback forces.** Kickback forces can be controlled by the operator, if proper precautions are taken. Do not let go of the chain saw.
- **Do not overreach and do not cut above shoulder height.** This helps prevent unintended tip contact and enables better control of the chain saw in unexpected situations.
- **Only use replacement bars and chains specified by the manufacturer.** Incorrect replacement bars and chains may cause chain breakage and/or kickback.



WARNING: Read the warning instructions that follow before you use the product.

Safety instructions for operation

- The information in this operator's manual is not a replacement for professional knowledge and experience. If you do not feel safe in the situation that you are in, stop the product. Turn to your servicing dealer or a professional chainsaw operator. Do not attempt any task that you feel unsure of!
- Turn to your servicing dealer or Husqvarna if you have questions about the operation of the product. We can give you information about how to operate your product effectively and safely. Participate in a training class in chainsaw operation if possible. Your servicing dealer, forestry school or your library can

give you information about training materials and classes that are available.

- You must understand the effects of kickback and how to prevent them before you use this product. See *What is kickback?* on page 16 and *Common questions about kickback* on page 17 for instructions.
- Do not use a product, battery or battery charger that is defective.
- Do not touch a rotating saw chain. It can cause serious injuries or death.
- Do not use the product if you are tired, while under the influence of alcohol or drugs, medicine or anything that could have a negative effect on your vision, alertness, coordination or judgment.
- Working in bad weather is tiring and often brings added risk. Due to the added risk, it is not recommended to use the machine in very bad weather, for instance in dense fog, heavy rain, strong winds, intense cold, risk of lightning, etc.
- Do not start a product unless the guide bar, saw chain and all covers are assembled correctly. If not, the drive sprocket can come loose and cause serious injuries. See *Assembly on page 12* for instructions.

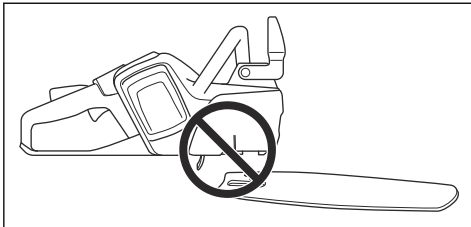

- Look around you. Make sure that there is no risk that persons or animals touch or influence on your control of the product.

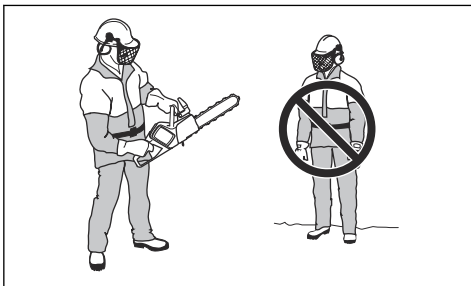

- Do not let children use or be near the product. The product is easy to start and children may be able to start it if they are not fully supervised. This can mean a risk of serious injury.
- Remove the battery when you do not have full view of the product or leave the product for any length of time.

- You must be stable on your feet in order to have full control of the product. Do not use the product if you are on a ladder or in a tree. Do not use the product if you are not on stable ground.

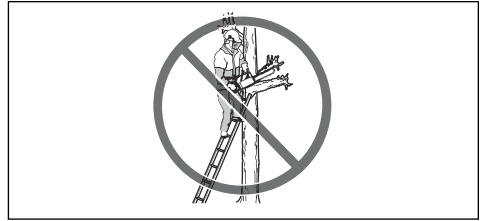

- If you are not careful, the risk of kickback increases. A kickback can occur if the kickback zone of the guide bar accidentally touches a branch, tree or other objects.

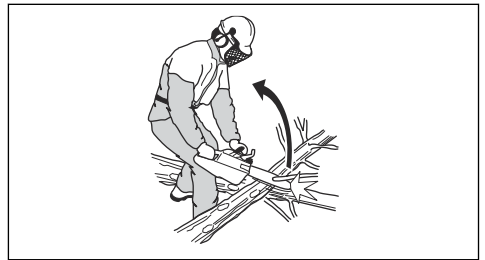

- Do not hold the product with one hand. This product is not safely controlled with one hand.
- Do not use the product above shoulder height and do not try to cut with the guide bar tip.

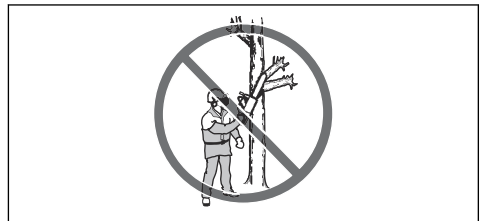

- Do not use a product in a situation where you can not call for help if an accident occurs.
- Stop the product and engage the chain brake before you move the product. Hold the product with the guide bar and saw chain pointing rearward. Put on a transportation guard on the guide bar before transportation or before you move it for any distance.
- When you put the product on the ground, engage the chain brake and have a constant view of the product. Stop the product and remove the battery before you leave your product for any length of time.
- There is a risk that wood chips get stuck in the drive system. This can cause the saw chain to get stuck. Always stop the product and remove the battery before you clean it.

- The vibration level increases if you cut with cutting equipment that is incorrect or not correctly sharpened. Cutting hardwoods, such as broadleaf trees, causes more vibration than cutting softwoods, such as conifers.

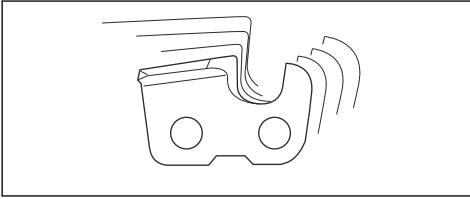

- Overexposure to vibration can lead to circulatory damage or nerve damage in persons who have decreased circulation. Speak to your physician if you experience symptoms of overexposure to vibration. Such symptoms include numbness, loss of feeling, tingling, pricking, pain, loss of strength, changes in skin colour or condition. These symptoms usually occur in the fingers, hands or wrists increases in cold temperatures.
- Do not try a pruning or limbing operation in a standing tree unless you have special training.
- Always stand on the uphill side of the log when you cut on a slope as the tree is likely to roll or slide downhill after it is felled. To maintain complete control of the product when you cut, release the cutting pressure near the end of the cut. Do not relax your hands around the handles. Do not let the saw chain to touch the ground. After you have completed the cut, wait for the saw chain to stop before you move the product. Always stop the motor before you move from tree to tree.

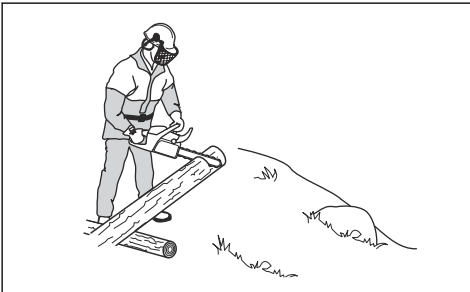

- Do not fell a tree if there is any risk that it endangers any person, strike or cause any utility line, or cause property damage. If the tree strikes a utility line, the utility company must be notified immediately.
- Make sure that you can move around safely. Examine the conditions and the terrain around you for possible obstacles such as roots, rocks, branches, ditches and more. Be careful when you do work on sloping ground.
- Prevent situations which you think is beyond your capability.

- It is not possible to include each possible situation you can face when you use this product. Always be careful and use your common sense.



Personal protective equipment



WARNING: Read the warning instructions that follow before you use the product.



- Most chainsaw accidents occur when the saw chain touches the operator. You must use approved personal protective equipment during operation. Personal protective equipment does not give you full protection from injuries but it decreases the degree of injury if an accident does occur. Turn to your servicing dealer for recommendations about which equipment to use.
- Use the correct protection for your arms. Your clothing must be close-fitting but not limit your movements. Regularly do a check of the condition of the personal protective equipment.
- Use an approved protective helmet.
- Use approved hearing protection. Long-term exposure to noise can result in permanent damage to the hearing.
- Always use protective glasses or a face visor to decrease the risk of injury from thrown objects. The product can throw objects such as wood chips, small pieces of wood and more, at large force. This can result in serious injury, especially to the eyes.
- Use gloves with saw protection.
- Use pants with saw protection.
- Use boots with saw protection, steel toe-cap and non-slip sole.
- Always have a first aid kit with you.
- Sparks can come from the product. Have fire extinguishing tools and a shovel available to prevent forest fires.

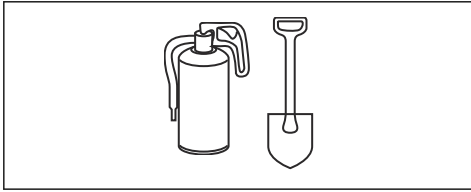

Safety devices on the product



WARNING: Read the warning instructions that follow before you use the product.

- Do not use a product with defective safety devices.
- Do a check of the safety devices regularly. Refer to *Maintenance and checks of the safety devices on the product on page 23.*
- If the safety devices are defective, speak to your Husqvarna servicing dealer.

Keypad

The warning indicator flashes if the chain brake is engaged or if there is a risk of overload. The overload protection temporarily stops the product and you can not use the product until the temperature restores. If the indicator shows a solid light, turn to your servicing dealer.

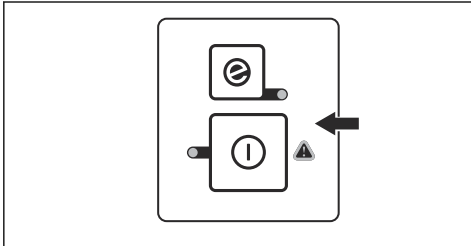

The automatic stop function

The product has an automatic stop function that stops the product if you do not use it for one minute.

Chain brake and front hand guard

Your product has a chain brake that stops the saw chain if you get a kickback. The chain brake decreases the risk of accidents, but only you can prevent them.

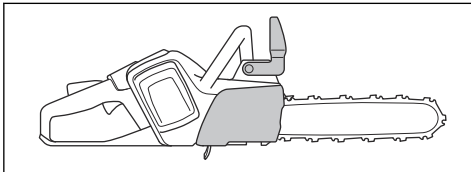

WARNING: Do not engage in situations where there is a risk of kickback. Be careful when you use your product and make sure that the kickback zone of the guide bar does not touch an object.

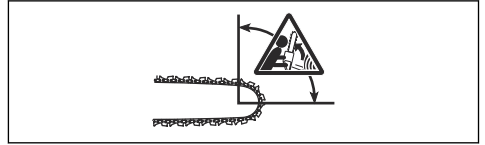

The chain brake engages (A) manually by your left hand or automatically by the inertia release mechanism. Push the front hand guard (B) forward to engage the chain brake manually. This movement starts a spring-loaded mechanism that stops the drive sprocket.

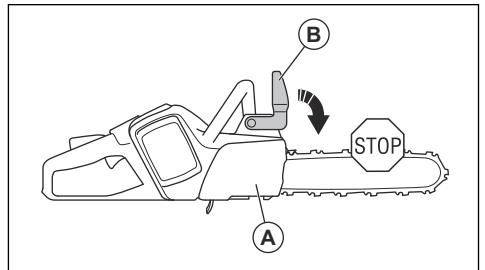

How the chain brake is engaged depends on the force of the kickback. It also depends on the position of the product when the kickback zone hits an object. If you get a intense kickback while the kickback zone is farthest away from you the chain brake engages by the inertia release. If the kickback is small or the kickback zone is nearer you the chain brake engages manually by your left hand.



Use the chain brake as a parking brake when you start the product and when you move short distances. This

decreases the risk that you or a person near you get hit by the saw chain.

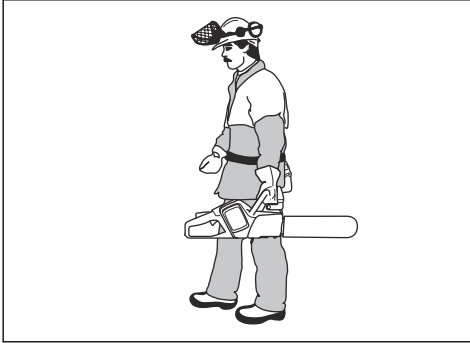

Pull the front hand guard rearward to disengage the chain brake.

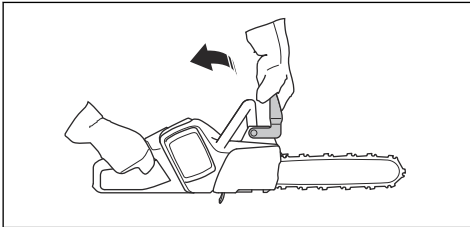

A kickback can be very sudden and intense. Most kickbacks are small and do not always engage the chain brake. If a kickback occur when you use the product, hold tight around the handles and do not let go.

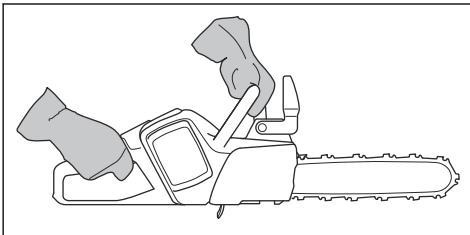

The front hand guard also decreases the risk to hit the saw chain if your hand lets go of the front handle.

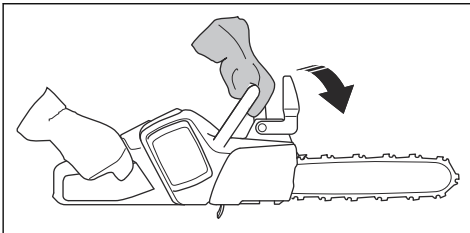

In the felling position you can not engage the chain brake manually. The chain brake can in this position only be engaged by the inertia release mechanism.

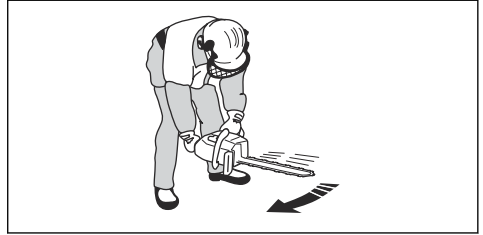

Power trigger lockout

The power trigger lockout prevents accidental operation of the power trigger. If you put your hand around the handle and press the power trigger lockout (A), it releases the power trigger (B). If you release the handle, the power trigger and the power trigger lockout move back to their initial positions.

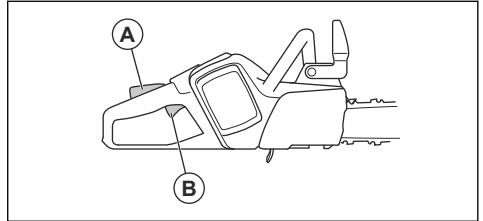

Chain catcher

The chain catcher catches the saw chain if it breaks or comes loose. If you have the correct chain tension, the risk decreases. You also decrease the risk if you do the correct maintenance on the guide bar and saw chain. See *Assembly on page 12* and *Maintenance on page 23* for instructions.

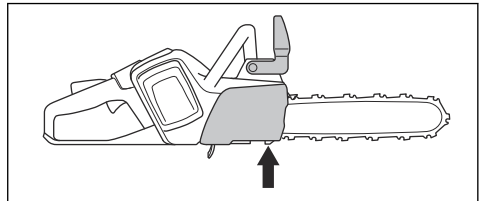

Right hand guard

The right hand guard works as a protection for your hand if the saw chain breaks or comes loose. It also

prevents interference from branches and twigs when you use the product.

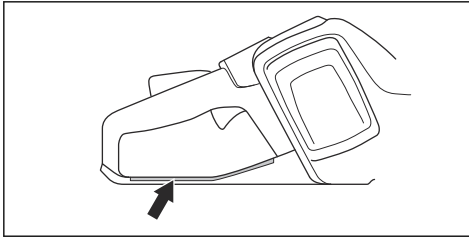

Battery safety



WARNING: Read the warning instructions that follow before you use the product.

- Only use the BLi batteries that we recommend for your product. The batteries are software encrypted.
- Use the BLi batteries that are rechargeable as a power supply for the related Husqvarna products only. To prevent injury, do not use the battery as a power supply for other devices.
- Risk of electrical shock. Do not connect the battery terminals to keys, screws or other metal. This can cause a short circuit of the battery.
- Do not use batteries that are non-rechargeable.
- Do not put objects into the air slots of the battery.
- Keep the battery away from sunlight, heat or open flame. The battery can blow up and cause burns and/or chemical burns.
- Keep the battery away from rain and wet conditions.
- Keep the battery away from microwaves and high pressure.
- Do not try to disassemble or break the battery.
- Do not let battery acid touch your skin. Battery acid causes injuries to the skin, corrosion and burns. If you get battery acid in your eyes, do not rub but flush with water for minimum 15 minutes. If battery acid has touched your skin, you must clean the skin with a large quantity of water and soap. Get medical aid.
- Use the battery in temperatures between -10 °C (14 °F) and 40 °C (104 °F).
- Do not clean the battery or the battery charger with water. See *To do a check of the battery and the battery compartment on page 25.*
- Do not use a defective or damaged battery.
- Keep batteries in storage away from metal objects such as nails, screws or jewelry.
- Keep the battery away from children.

Battery charger safety



WARNING: Read the warning instructions that follow before you use the product.

- Risk of electrical shock or short circuit if the safety instructions are not obeyed.
- Use an approved grounded mains socket that is not damaged.
- Do not use other battery chargers than the one supplied for your product. Only use Husqvarna QC chargers when you charge Husqvarna replacement batteries BLi.
- Do not try to disassemble the battery charger.
- Do not use a defective or damaged battery charger.
- Do not lift the battery charger by the power cord. To disconnect the battery charger from a mains socket, pull out the plug. Do not pull the power cord.
- Keep all cables and extension leads away from water, oil and sharp edges. Make sure that the cable is not caught between doors, fences or similar.
- Do not use the battery charger near flammable materials or materials that can cause corrosion. Make sure that the battery charger is not covered. Pull out the plug to the battery charger if there is smoke or fire.
- Only charge the battery indoors in a location with good airflow and away from sunlight. Do not charge the battery outdoors. Do not charge the battery in wet conditions.
- Only use the battery charger where the temperature is between 5 °C (41 °F) and 40 °C (104 °F). Use the charger in an environment which has a good airflow, dry and free from dust.
- Do not put objects into the cooling slots of the battery charger.
- Do not connect the battery charger terminals to metal objects as this can short circuit the battery charger.
- Use approved wall sockets that are not damaged.
- Use only three-wire outdoor extension cords that have three-prong grounding plugs and grounding receptacles that accept the appliance's plug.

Safety instructions for maintenance



WARNING: Read the warning instructions that follow before you do maintenance on the product.

- Remove the battery before you do maintenance, other checks or assemble the product.
- The operator must only do the maintenance and servicing shown in this operator's manual. Turn to your servicing dealer for maintenance and servicing of a larger extension.

- Do not clean the battery or the battery charger with water. Strong detergent can cause damage to the plastic.
- If you do not do maintenance, it decreases the life cycle of the product and increases the risk of accidents.
- Special training is necessary for all servicing and repair work, especially for the safety devices on the product. If not all checks in this operator's manual are approved after you have done maintenance, turn to your servicing dealer. We guarantee that there are professional repairs and servicing available for your product.
- Only use original spare parts.

- Keep the correct depth gauge setting! Follow our instructions and use the recommended depth gauge clearance. Too large a clearance increases the risk of kickback.

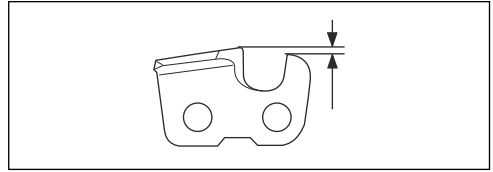

- Make sure that the saw chain has the correct tension! If the saw chain is not tight against the guide bar, the risk for it to come loose increases. This leads to increased wear on the guide bar, saw chain and drive sprocket.

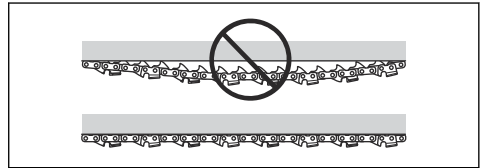

- Do maintenance on the cutting equipment regularly and keep it correctly lubricated. The risk of wear on the guide bar, saw chain and drive sprocket increases if the saw chain is not correctly lubricated.

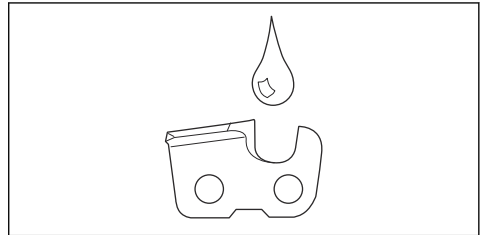

Safety instructions for the cutting equipment



WARNING: Read the warning instructions that follow before you use the product.

- Use the correct combination of guide bar and saw chain to decrease the risk of kickback! Only use the bar/saw chain combinations we recommend and use the correct filing equipment. See *Technical data on page 33* for instructions.

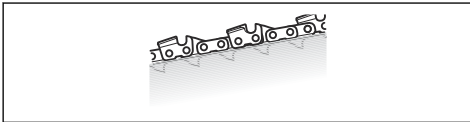

- Use protective gloves when you handle the saw chain. A saw chain that does not move can also cause injuries to a person that touches the saw chain.
- Keep the cutting teeth correctly sharpened! Follow our instructions and use the recommended file gauge. A damaged saw chain or a saw chain that has been incorrectly sharpened increases the risk of accidents.

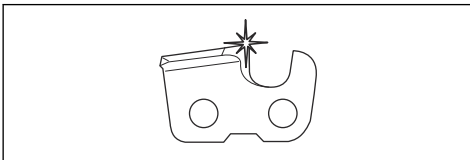

Assembly

To assemble the guide bar and saw chain (330i)



WARNING: Always remove the battery before you assemble or do maintenance on the product.

1. Disengage the chain brake.

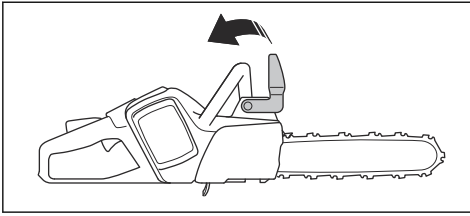

2. Loosen the knob and remove the drive sprocket cover (chain brake) and the transportation ring (A).

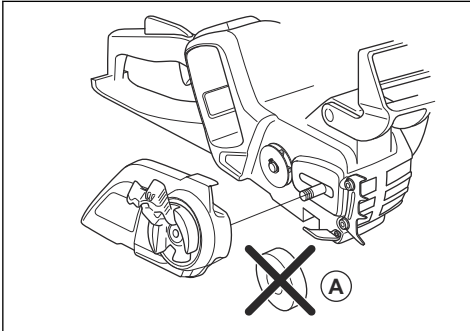

3. Put the guide bar on top of the bar bolt. Steer the guide bar to its most rear position. Lift the saw chain above the drive sprocket and engage it in the groove on the guide bar. Start on the top edge of the guide bar.
4. Make sure that the edges of the cutting links are turned forward on the top edge of the guide bar.

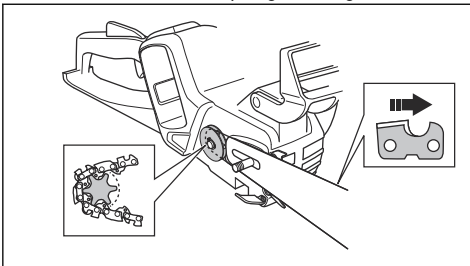

5. Make sure that the edges of the cutting links face forward on the top edge of the guide bar.
6. Assemble the drive sprocket cover and steer the chain adjuster pin to the hole in the guide bar.
7. Make sure that the drive links of the saw chain fit correctly on the drive sprocket.
8. Make sure that the saw chain is correctly engaged in the groove in the guide bar.
9. Tighten the saw chain. See *To tighten the saw chain on page 28* for instructions.

To assemble the guide bar and saw chain (535i XP)



WARNING: Always remove the battery before you assemble or do maintenance on the product.

1. Disengage the chain brake.

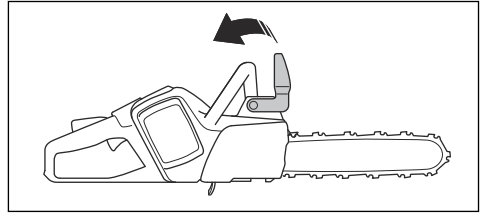

2. Loosen the bar nut and remove the drive sprocket cover and the transportation ring (A).

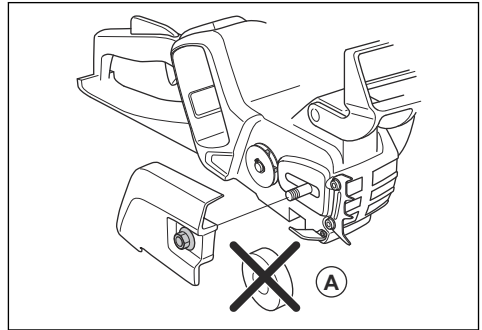

3. Put the guide bar on top of the bar bolt. Steer the guide bar to its most rear position. Lift the saw chain above the drive sprocket and engage it in the groove on the guide bar. Start on the top edge of the guide bar.
4. Make sure that the edges of the cutting links are turned forward on the top edge of the guide bar.

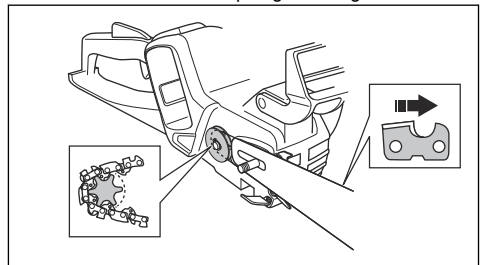

5. Make sure that the edges of the cutting links face forward on the top edge of the guide bar.
6. Assemble the drive sprocket cover and steer the chain adjuster pin to the hole in the guide bar.
7. Make sure that the drive links of the saw chain fit correctly on the drive sprocket.

8. Make sure that the saw chain is correctly engaged in the groove in the guide bar.
9. Tighten the bar nut finger-tight.
10. Tighten the saw chain. See *To tighten the saw chain on page 28* for instructions.

To assemble a spiked bumper

To assemble a spiked bumper, turn to your servicing dealer.

Operation

To do a function check before you use the product

1. Do a check of the chain brake to make sure that it operates correctly and that it is not damaged.
2. Do a check of the rear right hand guard to make sure that it is not damaged.
3. Do a check of the power trigger lockout to make sure that it operates correctly and that it is not damaged.
4. Do a check of the keypad to make sure that it operates correctly.
5. Make sure that there is no oil on the handles.
6. Do a check to make sure that all parts are correctly attached and not damaged or missing.
7. Do a check of the chain catcher to make sure that it is attached correctly.
8. Do a check of the chain tension.
9. Charge the battery and make sure that it is correctly attached to the product.
10. Make sure that the saw chain stops when you release the power trigger.

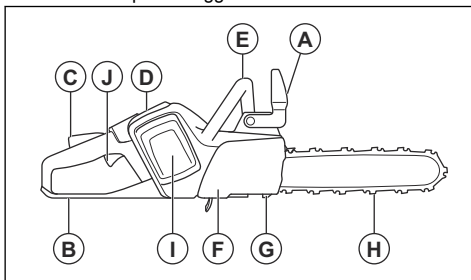

Chain oil

All Husqvarna chainsaws have an automatic chain lubrication system. On some models the oil flow is also adjustable.

Think about the following when you select a chain oil:

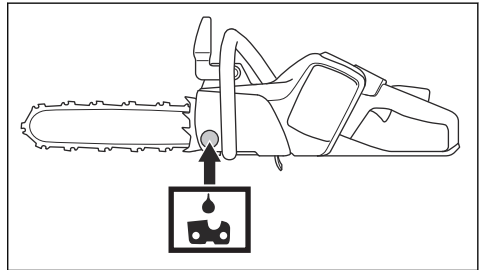

- The oil tank lasts approximately three battery charges. This applies only if you use the correct chain oil. If the chain oil is too thin, it will not last that long.
- Chain oil must show good adherence to the saw chain and also keep its flow quality during warm summer and cold winter weather.
- Use an oil of the right grade (suitable viscosity range) to agree with the air temperature. In temperatures below 0°C (32°F) some oils become too thick. This can cause the oil pump to overload and result in damage to the oil pump components.
- Use the recommended cutting equipment. A guide bar that is too long will use more chain oil.
- Turn to your servicing dealer when you select a chain oil.



WARNING: Do not use waste oil! Waste oil is dangerous to you and the environment. Waste oil also causes damage to the oil pump, the guide bar and the saw chain.



WARNING: If the lubrication of the cutting equipment is not sufficient, it can cause the saw chain to break. This can cause serious injury or death to the operator.



CAUTION: If you use vegetable based chain oil, clean the groove in the guide bar and saw chain before long-term storage. Otherwise there is a risk of the saw chain

oxidizing, which causes the saw chain to become stiff and that the bar tip sprocket gets clogged.

To connect the battery charger

1. Connect the battery charger to the voltage and frequency that is specified on the rating plate.
2. Put the plug in a grounded socket outlet. The LED on the battery charger flashes green one time.

Note: The battery does not charge if the battery temperature is more than 50 °C/122 °F. If the temperature is more than 50 °C/122 °F, the battery charger makes the battery become cool before the battery charges.

To connect the battery to the battery charger

Note: Charge the battery if it is the first time that you use it. A new battery is only 30% charged.

1. Make sure that the battery is dry.
2. Put the battery in the battery charger.

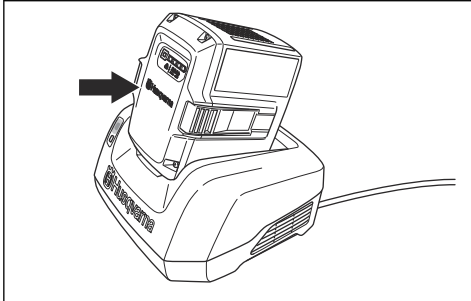

3. Make sure that the green charging light on the battery charger comes on. That means that the battery is connected correctly to the battery charger.

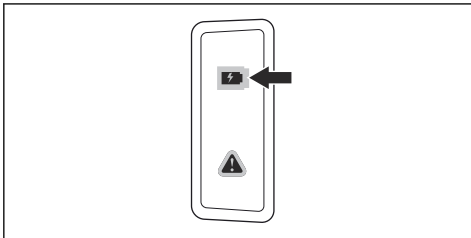

4. When all LEDs on the battery come on, the battery is fully charged.

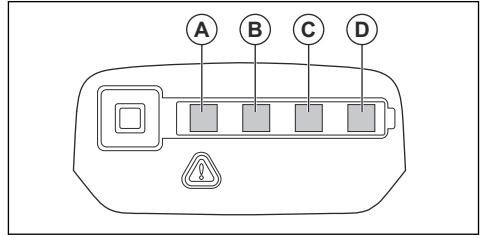

5. To disconnect the battery charger from the mains socket, pull the plug. Do not pull the cable.
6. Remove the battery from the battery charger.

Note: Refer to the battery and battery charger manuals for more information.

To start the product

1. Do a check of the power trigger and power trigger lockout. See *To do a check of the power trigger lockout on page 24.*
2. Push the front hand guard forward to engage the chain brake.

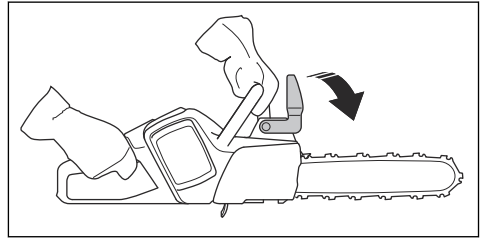

3. Put the battery in the battery holder.

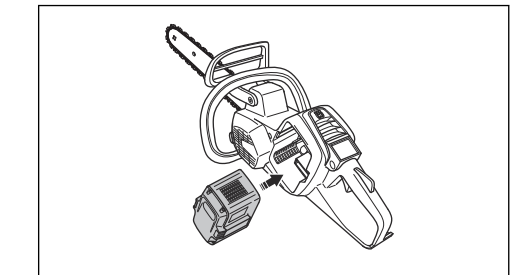

4. Press on the lower part of the battery until you hear a click sound.



CAUTION: If the battery does not move into the battery holder easily, it is not attached correctly into the battery holder.

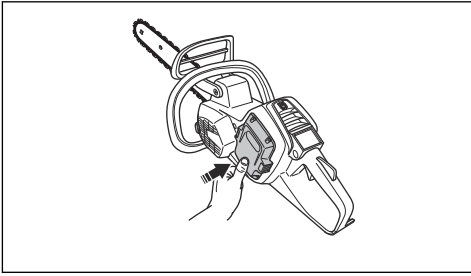

To stop the product

1. Press and hold the start/stop button on the keypad until the green LED light comes off.

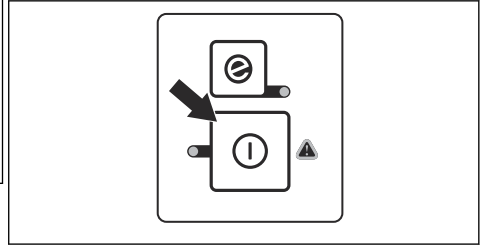

5. Press and hold the start/stop button until the green LED light comes on.

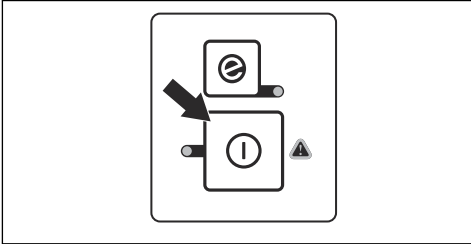

2. Pull out the battery and press the battery release buttons to remove the battery from the battery holder.

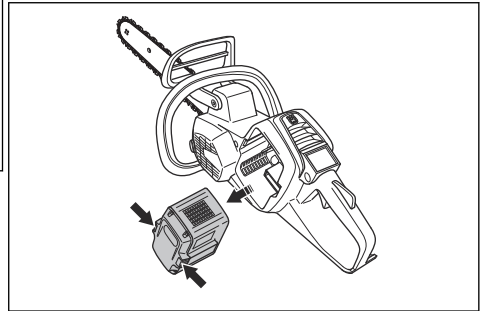

To use the SavE function

This product has a power saving function, SavE. The SavE function decreases the chain speed and gives the longest operation time from the battery.

Note: The SavE function does not decrease the cutting power of the product.

1. Press the SavE button on the keypad.
2. Make sure that the green LED comes on.
3. Press the SavE button again to disconnect the function. The green LED goes out.

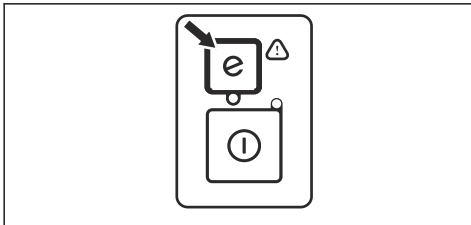

WARNING: Remove the battery when you do not use or when you do not have full vision of the product. This is to prevent accidental start.

What is kickback?



WARNING: If a kickback occurs when the saw chain rotates, it can cause serious injuries or death to the operator. It is vital that you understand the causes of kickback and that you can prevent them with correct working technique. If you are prepared you decrease the risk.

A kickback occur when the kickback zone touches an object with a rotating saw chain. A kickback can occur

suddenly and with large force, which throws the product, guide bar and saw chain against the operator.

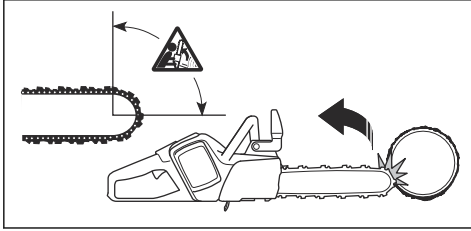

Kickback always occurs in the cutting plane of the guide bar. Usually, the product, guide bar and saw chain are thrown against the operator but can also move in a different direction. It is how you use the product when the kickback occurs that causes the direction of movement.



Kickback only occurs if the kickback zone of the guide bar touches an object. Do not let the kickback zone touch an object.

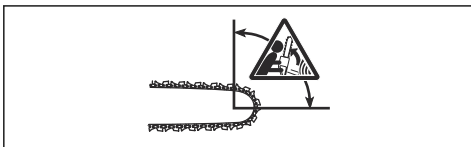

The smaller the bar tip radius the lower the risk of kickback.

A saw chain is made up of a number of links, which are available as standard and low kickback. You can decrease the effects of kickback by using the correct cutting equipment with kickback reduction.



WARNING: No saw chain fully prevents the dangerous situations that can occur during a kickback.

Common questions about kickback

- **Will the hand always engage the chain brake during a kickback?**

No. It is necessary to use some force to push the front hand guard forward. If you do not use the force necessary, the chain brake may not be engaged. This can occur if your hand only lightly touches the front hand guard. You must also hold the handles of the product stable with two hands during work. If a kickback occurs, your hand may not let go of the front handle. Then it will not engage the chain brake, or the chain brake will only engage after the product has moved around a large distance. If this situation occurs, the chain brake may not stop the saw chain before it touches you. There are also some positions in which your hand can not touch the front hand guard to engage the chain brake. An example of this is in the felling position.

- **Will the inertia release mechanism always engage the chain brake during kickback?**

No. First, the chain brake must work correctly. See *Maintenance and checks of the safety devices on the product on page 23* for instructions about how to do a check of the chain brake. We recommend you to do this each time before you use the product. Second, the kickback must be intense to engage the chain brake. If the chain brake is too sensitive it will be engaged all the time.

- **Will the chain brake always protect me from injury during a kickback?**

No. The chain brake must work correctly in order to give the correct protection. The chain brake must also be engaged during a kickback to stop the saw chain. If you are near the guide bar, the chain brake may not have time to stop the saw chain before it hits you.



WARNING: Only you and the correct working technique can prevent kickbacks.

To use the cutting technique



WARNING: Use full power when you cut and decrease the speed to idle after each cut.



CAUTION: Motor damage can occur if the motor runs for too long at full power without load. For example if the motor runs for too long without resistance from the saw chain during cutting.

You can use the product to cut through wood in two different positions.

- To cut on the pull stroke is when you cut with the bottom of the guide bar. The saw chain pulls through

the tree when you cut. In this position you have better control of the product and the position of the kickback zone.

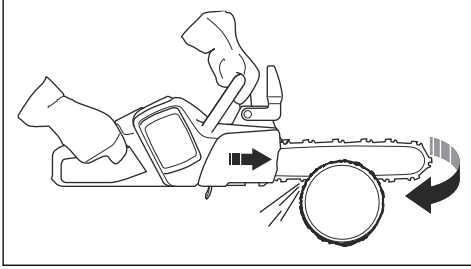

- To cut on the push stroke is when you cut with the top of the guide bar. The saw chain pushes the product in the direction of the operator.



WARNING: Be careful when you cut on the push stroke. If the saw chain gets trapped in the trunk, the product can be pushed at you. You must prevent this force or there is a risk that the kickback zone of the guide bar touches the tree. This will lead to a kickback.

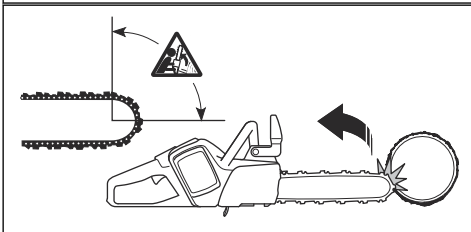
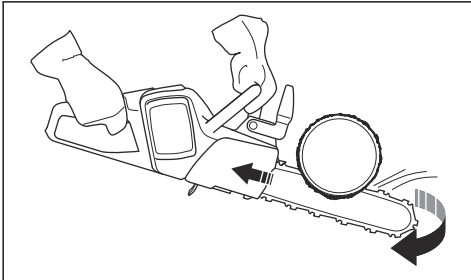

1. Put the trunk on a saw horse or runners.

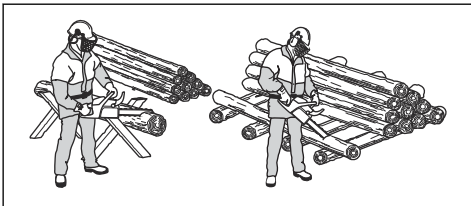

WARNING: Do not try to cut trunks in a pile. That increases the risk of kickback and can result in serious injury or death.

2. Cut the trunks one by one.
3. Remove the cut pieces from the cutting area.



WARNING: The kickback risk increases if you keep cutting pieces in the cutting area. It is also a risk that you do not keep your balance during operation.

To cut a trunk on the ground



WARNING: Follow the steps below to prevent the saw chain from touching the ground or an object.

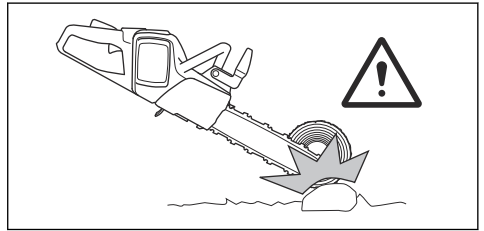

Note: To cut trunks on the ground decreases the risk that the saw chain gets trapped or that the object breaks.

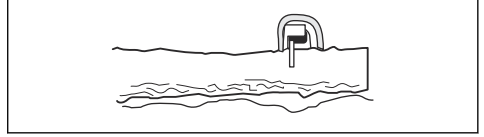

1. Cut through the trunk on the pull stroke. Do not let the saw chain touch the ground when you complete the kerf. Keep full power but be prepared for sudden accidents.

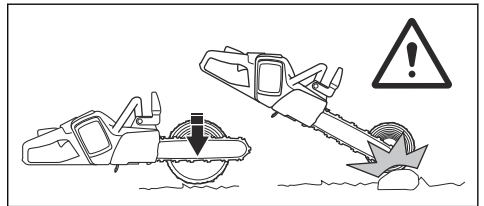

2. To prevent accidents, cut approximately 2/3 through the trunk and then stop. Turn the trunk and cut from the opposite side to complete the task.

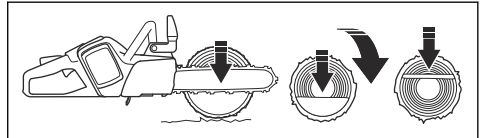

To cut a trunk with support on one end



WARNING: Follow the steps below to prevent the trunk from breaking before the cutting is complete.

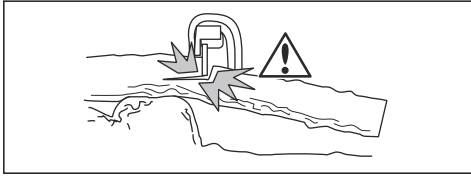

1. Cut on the push stroke approximately 1/3 through the trunk.
2. Cut through the trunk on the pull stroke until the two kerfs touch.

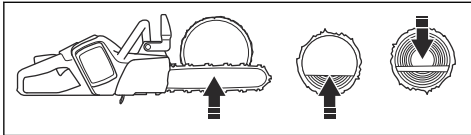

To cut a trunk with support on two ends



WARNING: Follow the steps below to prevent the saw chain from getting trapped in the trunk.

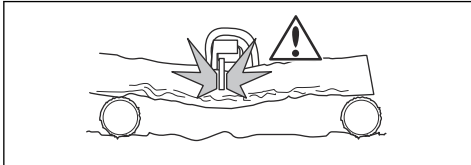

1. Cut on the pull stroke approximately 1/3 through the trunk.
2. Cut through the remaining part of the trunk on the push stroke until the two kerfs touch.

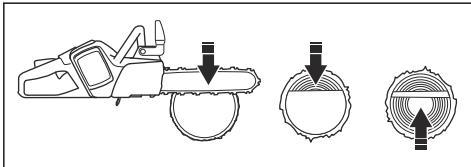

WARNING: If the saw chain gets trapped in the trunk, stop the motor! Do not try to pull the product free. If you do, there is a risk of injury when the product suddenly breaks free. Use a lever to open up the cut and free the product.

To use the limbing technique

Note: If you are to use the limbing technique on thick branches, use the same procedure as for the cutting technique.

1. Keep the larger, lower branches on the tree to give it support on the ground.
2. Cut limbs one by one.
3. Cut branches that are in tension from the bottom up.

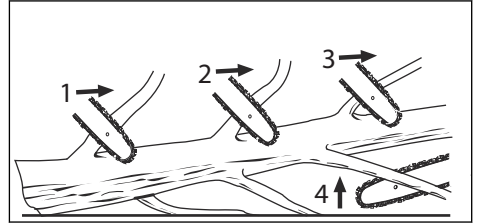

4. Cut branches piece by piece if necessary.

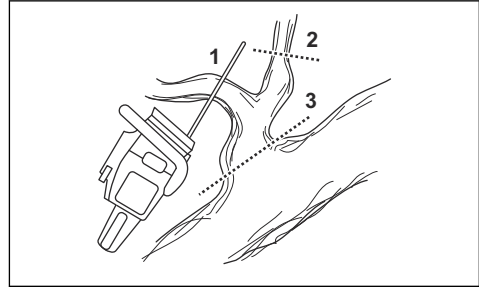

WARNING: Be careful when you remove small branches and do not cut bushes or many small branches at the same time. Small and light branches can get trapped by the saw chain and be thrown at you. This can mean that you can not keep control of the product, which can cause serious injury.

5. Work on the left side of the trunk. Be as close as possible to the product for maximum control. Let the weight of the product be on the trunk if possible.





WARNING: Most kickback accidents occur during limbing. Do not touch the trunk, other limbs or objects with the guide bar tip or the kickback zone. Be careful with limbs that are in tension. They can be thrown at you and cause serious injury.

6. Keep the trunk between you and the product as you move along the trunk.

To use the tree felling technique



WARNING: You must have much experience to fell a tree. Operators without experience must not fell trees.

To keep a safe distance

1. Make sure that persons around you keep a safe distance at a minimum of 2 1/2 tree lengths.

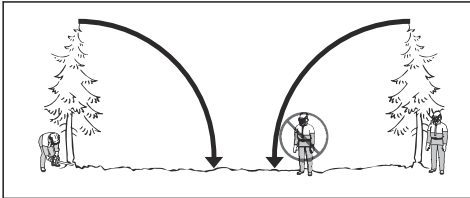

2. Make sure that no person is in the risk zone before or during felling.

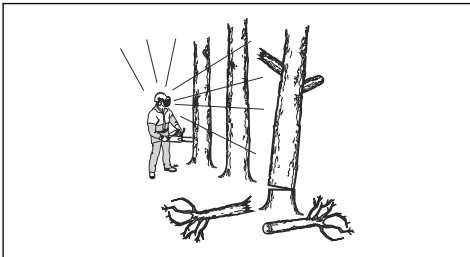

To calculate the felling direction

1. Examine in which direction it is necessary for the tree to fall. The goal is to fell it in a position where you can limb and cut the trunk easily. It is also important that you are stable on your feet and can move about safely.



WARNING: Let the tree fall in its natural fall direction if it is not possible or dangerous to fell it differently.

2. Examine the natural fall direction of the tree. For example the tilt and bend of the tree, wind direction, the location of the branches and weight of snow.
3. Examine if there are obstacles, for example other trees, power lines, roads and/or buildings around.

4. Look for signs of damage and rot in the stem.



WARNING: Rot in the stem can mean a risk that the tree falls before you complete the cutting.

5. Make sure the tree has no damaged or dead branches that can break off and hit you during felling.
6. Do not let the tree fall onto a different tree. It is dangerous to remove a trapped tree and there is a high accident risk. See *To free a trapped tree on page 22.*

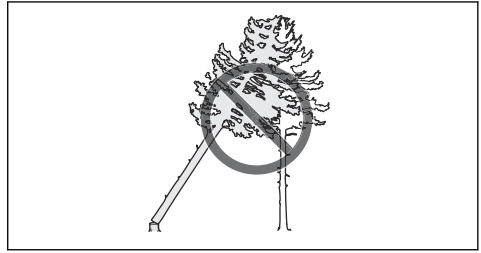

WARNING: During critical felling operations, lift your hearing protection immediately when the sawing is complete. It is important that you hear sounds and warning signals.

To clear the trunk and prepare your path of retreat

1. Use the limbing technique to free the tree from branches from your shoulder height and down. Start from the top down and make sure that the tree is between you and the product.

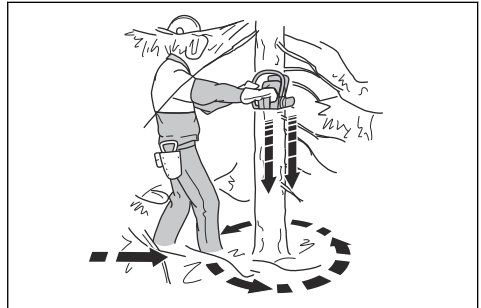

2. Remove dirt, stones, loose bark, nails, staples and wire from the tree where the felling cuts are made. Remove undergrowth from the bottom of the tree.
3. Do a check of the area for obstacles such as stones, branches and holes. You must have a clear path of retreat when the tree starts to fall. Your path of retreat must be approximately 135 degrees away from the felling direction.

1. **The danger zone**

2. **The path of retreat**
3. **The felling direction**

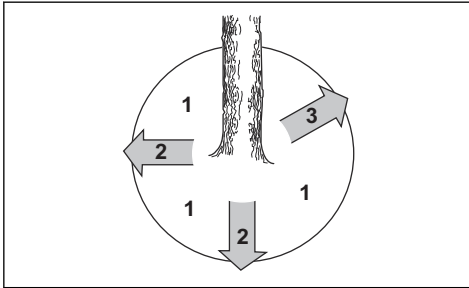

To fell a tree

You use three cuts to fell a tree. These are the directional cuts, which include the top cut and the bottom cut, and the felling cut. If you make these cuts correctly, you can control the felling direction very accurately.



WARNING: Do not fell trees with a diameter larger than the bar length of your product, unless you have special training! This includes a much larger risk that the kickback zone of the guide bar touches the tree.

To make the directional cuts

1. Make the directional cuts. Run the directional cuts 1/4 of the diameter of the tree. Make a 45° angle between the top cut and bottom cut.
 - a) Make the top cut first. Align the felling direction mark (A) of the product with the felling direction of the tree (B). Stay behind the product and keep the tree on your right side. Cut with a pull stroke.
 - b) Make the bottom cut. Make sure that the end of the bottom cut is at the same point as the end of the top cut.

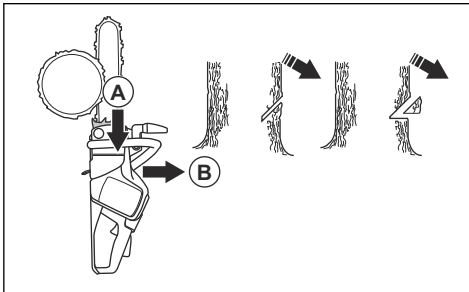

2. Make sure that the directional cut line is perfectly horizontal and at right angles (90°) to the felling direction. The directional cut line goes through the point where the two directional cuts touch.

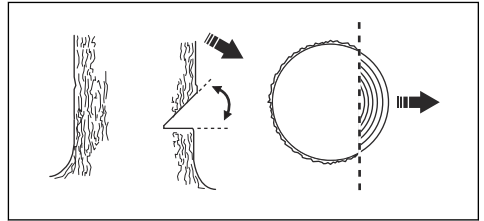

To make the felling cut

1. Switch to the left side of the tree. The felling cut is made on the opposite side of the tree.
2. Make the felling cut approximately 3-5 cm/1.5-2 in above the bottom directional cuts. The cut must be perfectly horizontal.

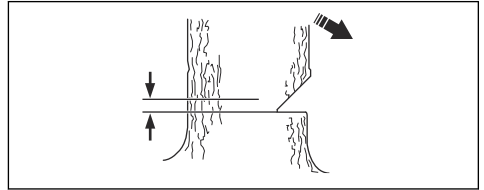

3. Cut on the pull stroke, use full power and forward the saw chain/guide bar slowly into the tree. Make sure that the tree does not fall in an unwanted direction.
4. Operate a wedge or breaking bar into the cut when the cut has accurate depth.

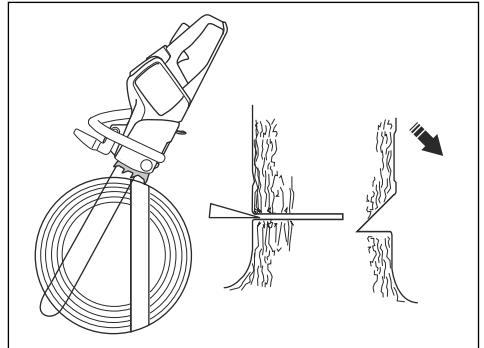

5. Complete the felling cut parallel with the directional cut line. Make sure that the distance between them is at a minimum of 1/10 of the trunk diameter. The section of the trunk that is not cut is the felling hinge. The felling hinge controls the direction that the tree falls in.

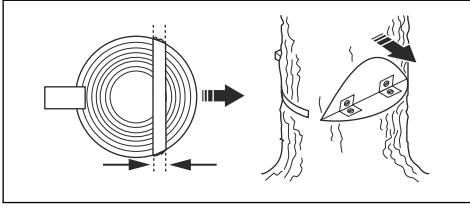

WARNING: You have no control of the felling direction if the felling hinge is gone or if it is too thin. This also applies to if you have not made the directional cuts and felling cut correctly.

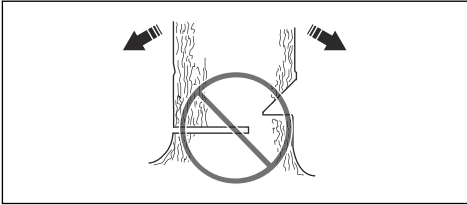

6. At this time, the tree will fall by its own force or with the aid of a wedge or breaking bar.

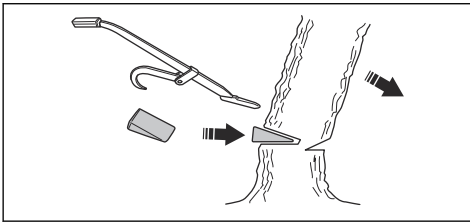

Note: Use a guide bar that is longer than the diameter of the tree. This helps you to make the felling cut and directional cuts with one cutting stroke each. See *Accessories on page 34* to find out which bar lengths we recommended for your product.

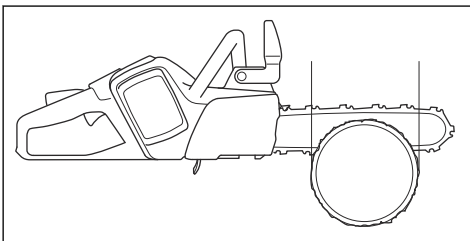

There are procedures for felling trees with a diameter larger than the guide bar length. But, these procedures include a much larger risk that the kickback zone of the guide bar will touch the tree.

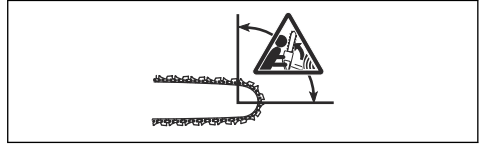

To free a trapped tree



WARNING: It is very dangerous to remove a trapped tree and there is a high accident risk. Keep out of the risk zone and do not try to fell a trapped tree.

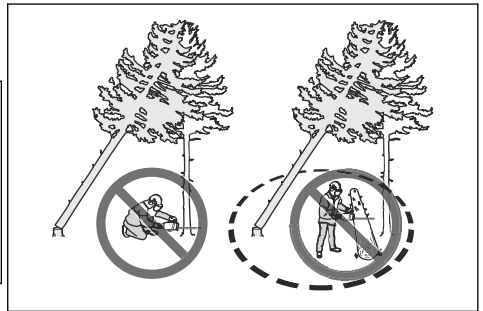

The safest procedure is to use one of the following winches:

- Tractor-mounted

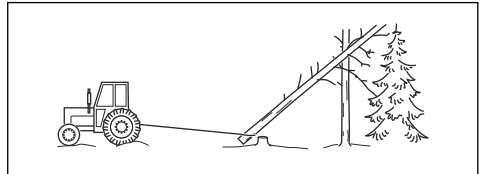

- Portable

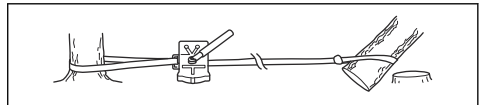

To cut trees and branches that are in tension

1. Figure out which side of the tree or branch that is in tension.

2. Figure out where the point of maximum tension is.

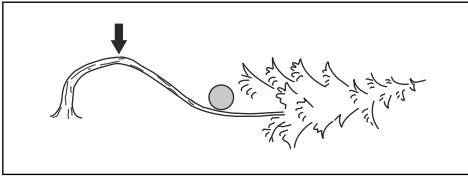

3. Examine which is the safest procedure to release the tension.

Note: In some situations the only safe procedure is to use a winch and not your product.

4. Keep a position where the tree or branch can not hit you when the tension is released.

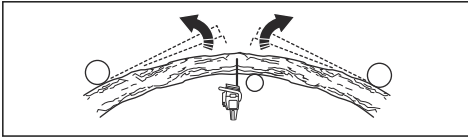

5. Make one or more cuts of sufficient depth necessary to decrease the tension. Cut at or near the point of maximum tension. Make the tree or branch break at the point of maximum tension.

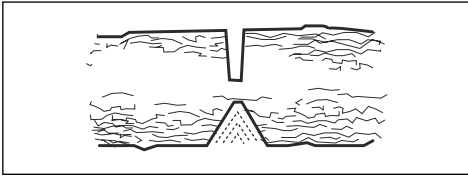

WARNING: Do not cut straight through a tree or branch that is in tension.



WARNING: Be very careful when you cut a tree that is in tension. There is a risk that the tree moves quickly before or after you cut it. Serious injury can occur if you are in an incorrect position or if you cut incorrectly.

6. If you must cut across tree/branch, make 2 to 3 cuts, 1 in. apart and with a depth of 2 in.

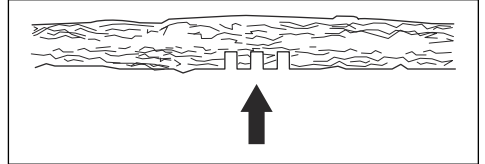

7. Continue to cut more into the tree until the tree/branch bends and the tension is released.

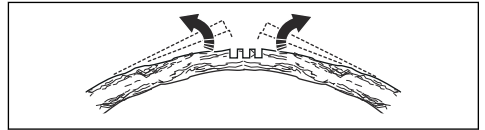

8. Cut the tree/branch from the opposite side of the bend, after the tension is released.

Maintenance

Introduction



WARNING: Before you do maintenance, you must read and understand the safety chapter.

Maintenance and checks of the safety devices on the product

To do a check of the front hand guard

Regularly do a check of the front hand guard and the inertia brake release.

1. Make sure that the front hand guard is not damaged and that there are no defects, such as cracks.

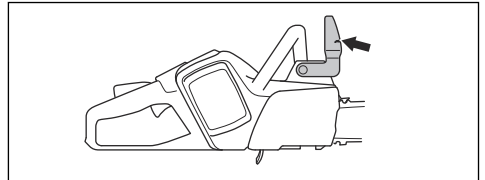

2. Make sure that the front hand guard moves freely and that it is attached safely to the product.

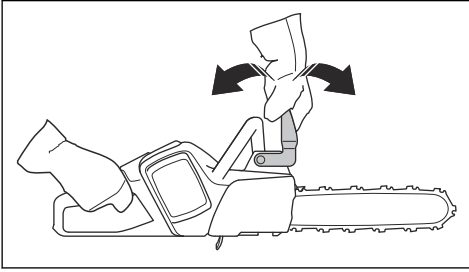

3. Put the product, with the motor off, on a stump or other stable surface.
4. Hold the rear handle and let go of the front handle. Let the product fall against the stump.



5. Make sure that the chain brake engages as the guide bar hits the stump.

To do a check of the brake trigger

1. Put the product on stable ground and start it. See *To start the product on page 15.*



WARNING: Make sure that the saw chain does not touch the ground or other objects.

2. Wrap your fingers and thumbs around the handles and hold the product tight.

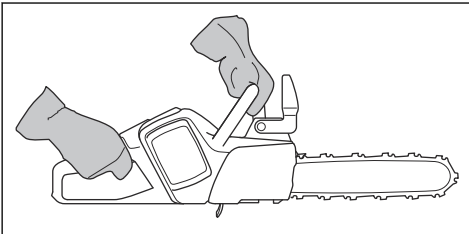

3. Apply full power and tilt your left wrist against the front hand guard to engage the chain brake. The saw chain must stop immediately.

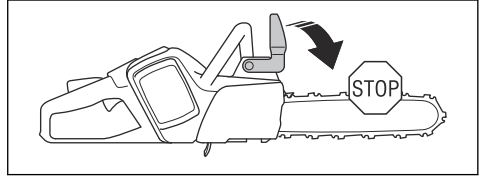

WARNING: Do not let go of the front handle!

To do a check of the power trigger lockout

1. Make sure that the power trigger and power trigger lockout move freely and that the return spring works correctly.

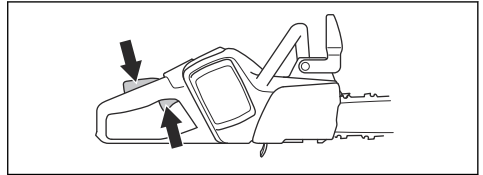

2. Press down the power trigger lockout and make sure that it goes back to its initial position when you release it.

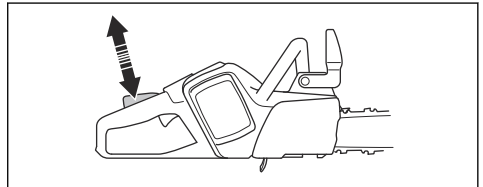

3. Make sure that the power trigger is locked at the idle position when the power trigger lockout is released.

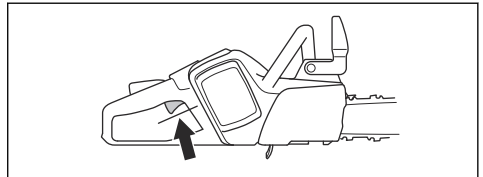

4. Start the product and apply full power.
5. Release the power trigger and make sure that the saw chain stops and stays stationary. If the saw chain rotates when the power trigger is in the idle position, turn to your servicing dealer.

To do a check of the chain catcher

1. Make sure that there is no damage on the chain catcher.

2. Make sure that the chain catcher is stable and attached to the body of the product.

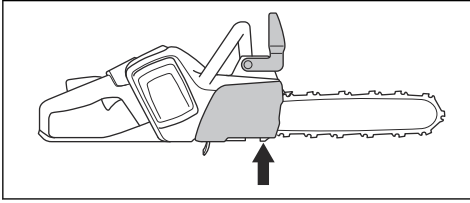

To do a check of the keypad

1. Start the product. See *To start the product on page 15*
2. Press the start/stop button again.
3. Make sure that the product stops when you press and hold the button. The green LED will go off.

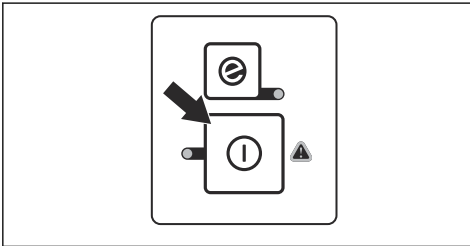

To do a check of the battery and the battery compartment

1. Clean the battery and the battery compartment with a soft brush.
2. Make sure that the cooling slots and battery connectors are clean.

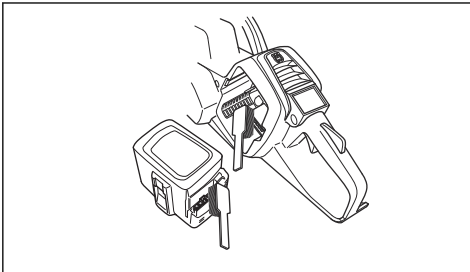

3. Make sure that the battery is not damaged and there are no other defects, such as cracks.

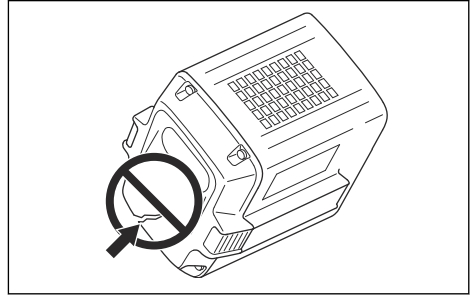

To do a check of the battery charger

1. Make sure that the battery charger and the power supply cord is not damaged. Look for cracks and other defects.

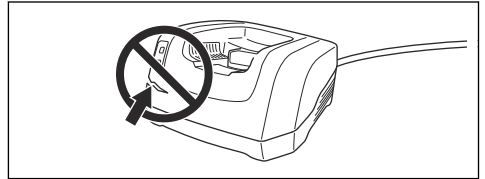

To clean the cooling system

The product has a cooling system that keeps the temperature of the product as low as possible.

The cooling system includes an air intake on the left side of the product and a fan on the motor.

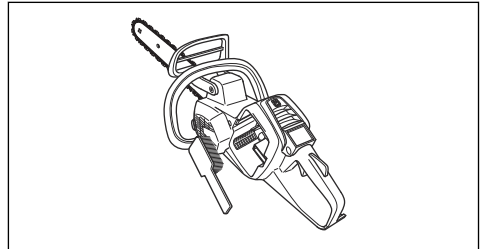

1. Clean the cooling system with a brush weekly or more frequently if necessary.
2. Make sure that the cooling system is not dirty or blocked.



CAUTION: A dirty or blocked cooling system can cause the product to become too hot. This causes damage to the piston and cylinder.

To sharpen the saw chain

Information about the guide bar and saw chain

Replace a worn or damaged guide bar or saw chain with the guide bar and saw chain combinations recommended by Husqvarna. This is important in order to keep the safety functions of the cutting equipment. See *Accessories on page 34*, for a list of replacement bar and chain combinations that we recommend.

- Length, in/cm.

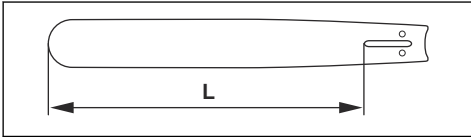

- Number of teeth on bar tip sprocket (T).

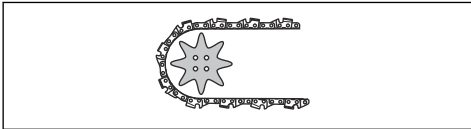

- Chain pitch, in. The distance between the drive links of the saw chain must align with the distance of the teeth on the bar tip sprocket and drive sprocket.

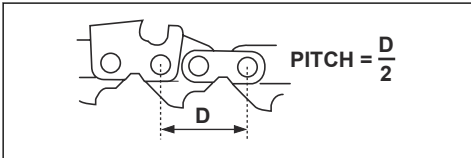

- Number of drive links. The number of drive links is decided by the length of the bar, the chain pitch and the number of teeth on the bar tip sprocket.

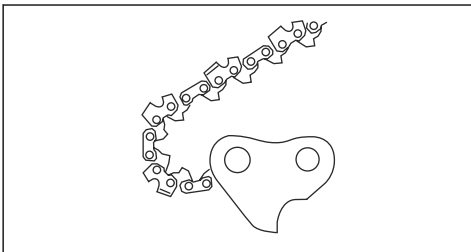

- Bar groove width, in/mm. The groove in the guide bar must align with the width of the chain drive links.

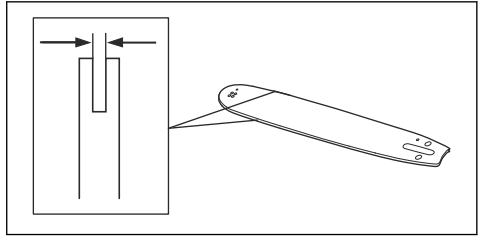

- Chain oil hole and hole for chain tensioner. The guide bar must align with product.

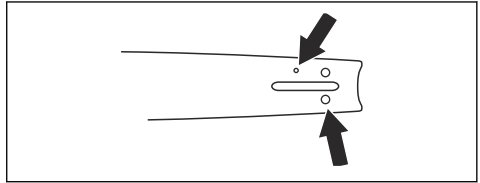

- Drive link width, mm/in.

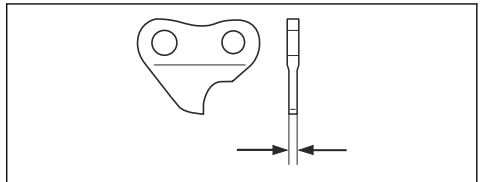

General information about how to sharpen the cutting teeth

Do not use a blunt saw chain. If the saw chain is blunt, you must apply more pressure to push the guide bar through the wood. If the saw chain is very blunt, there will be no wood chips but sawdust.

A sharp saw chain eats through the wood and the wood chips becomes long and thick.

The cutting tooth (A) and the depth gauge (B) together makes the cutting part of the saw chain, the cutter. The difference in height between the two gives the cutting depth (depth gauge setting).

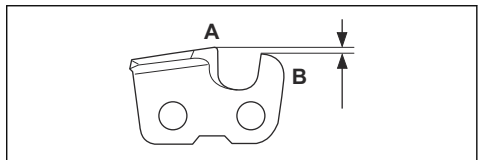

When you sharpen a cutting tooth, think about the following:

- Filing angle.

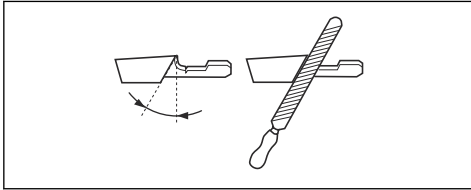

- Cutting angle.

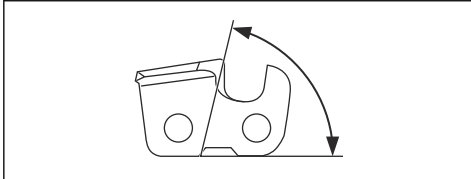

- File position.

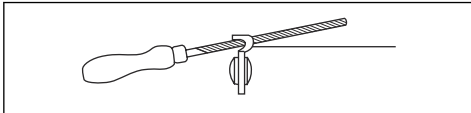

- Round file diameter.

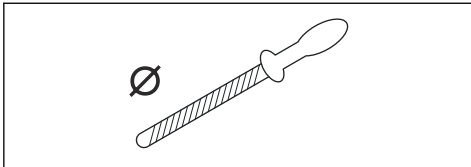

It is not easy to sharpen a saw chain correctly without the correct equipment. Use Husqvarna file gauge. This will help you to keep maximum cutting performance and the kickback risk at a minimum.



WARNING: The risk of kickback increases a lot if you do not follow the sharpening instructions.

Note: See *Filing equipment and filing angles on page 34* for information about sharpening of the saw chain.

To sharpen the cutting teeth

1. Use a round file and a file gauge to sharpen the cutting teeth.

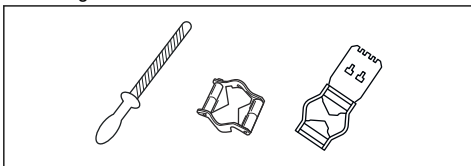

Note: See *Filing equipment and filing angles on page 34* for information about which file and gauge that Husqvarna recommends for your saw chain.

2. Make sure that the saw chain has the correct tension. A saw chain without the correct tension moves from side to side. This does not make it easy to sharpen the saw chain. See *To tighten the saw chain on page 28* for instructions.

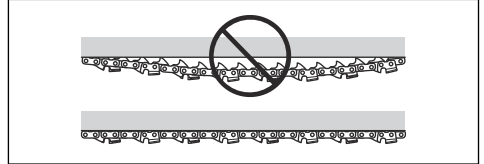

3. Move the file from the inner side of the cutting teeth and out. Decrease the pressure on the pull stroke.

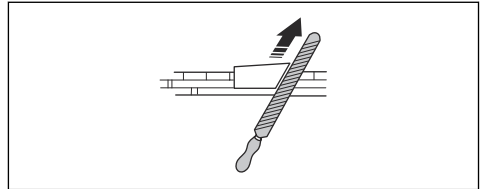

4. Remove filing material on all teeth on one side first.
5. Turn the product around and remove filing material on the other side.
6. Make sure that the all cutting teeth become the same length when you remove filing material.
7. The saw chain is worn out when the cutting teeth is decreased to 4 mm (0.16"). Replace the saw chain.

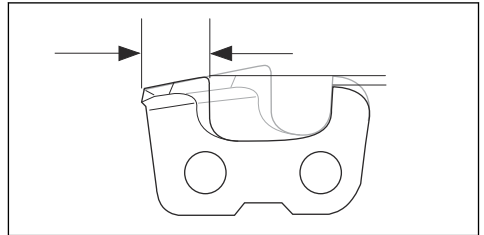

General information about how to adjust the depth gauge setting

The depth gauge setting (C) decreases when you sharpen the cutting tooth (A). To keep maximum cutting performance you must remove filing material from the depth gauge (B) to receive the recommended depth gauge setting. See *Accessories on page 34* for

instructions about how to receive the correct depth gauge setting for your saw chain.

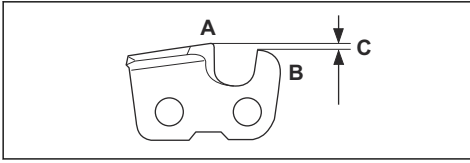

WARNING: The risk of kickback increases if the depth gauge setting is too large!

To adjust the depth gauge setting

Before you adjust the depth gauge setting or sharpen the cutting teeth, See *To sharpen the cutting teeth on page 27*, for instructions. We recommend you to adjust the depth gauge setting after each third operation that you sharpen the cutting teeth.

Note: This recommendation applies only if the length of the cutting teeth does not decrease too much.

We recommend that you use our depth gauge tool to receive the correct depth gauge setting and bevel for the depth gauge.

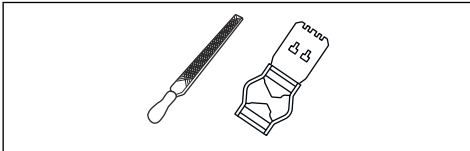

1. Use a flat file and a depth gauge tool to adjust the depth gauge setting. Only use Husqvarna depth gauge tool to receive the correct depth gauge setting and bevel for the depth gauge.
2. Put the depth gauge tool on the saw chain.

Note: See the package of the depth gauge tool for more information about how to use the tool.

3. Use the flat file to remove the part of the depth gauge that extends through the depth gauge tool.

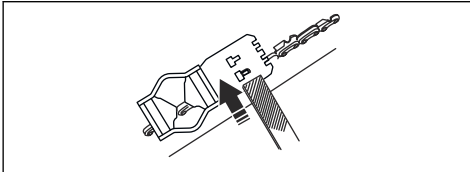

Note: The depth gauge setting is correct when you do not feel resistance as you move the file along the depth gauge tool.

To tighten the saw chain



WARNING: A saw chain without the correct tension can come loose from the guide bar and cause serious injury or death.

The more you use a saw chain the longer it becomes. It is important to adjust the saw chain regularly.

Do a check of the saw chain tension each time you refill with chain oil.

Note: A new saw chain has a running-in period during which you must do a check of the tension more frequently.

To tighten the saw chain (330i)

1. Fold the knob out until it opens.

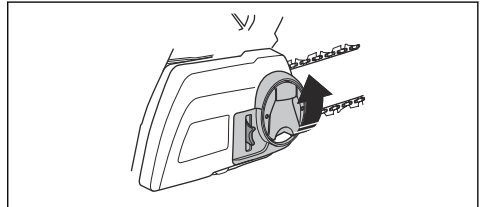

2. Turn the knob counterclockwise to loosen the drive sprocket cover.

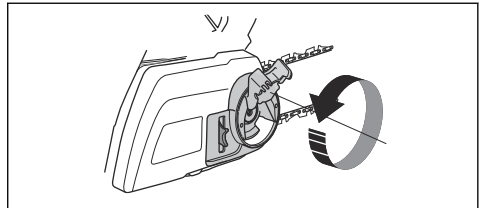

3. Turn the chain tensioner wheel to adjust the tension on the saw chain. The saw chain must be tight against the guide bar.

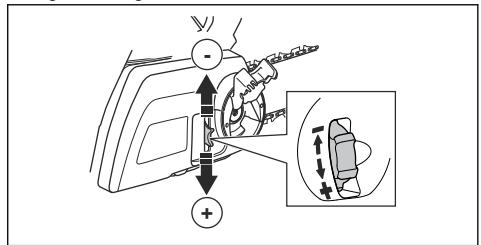

Note: Turn the wheel down (+) for more tension and up (-) for less tension. The saw chain is tightened correctly when you can turn it easily by hand but is tight against the guide bar.

- Turn the knob clockwise to tighten the bar knob.

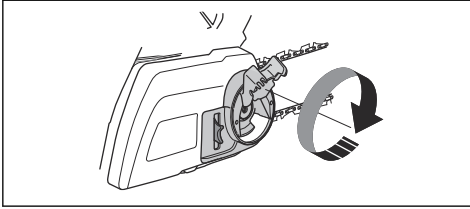

- Fold down the knob to lock the tension.

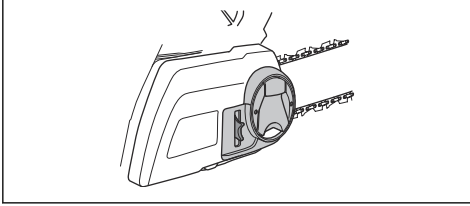

- Do a check of the chain tension frequently, until the saw chain is run-in.
- Do a check of the chain tension regularly to keep good cutting performance and a long life.

To tighten the saw chain (535i XP)

- Loosen the bar nut(s) that hold the drive sprocket cover. Use a wrench.

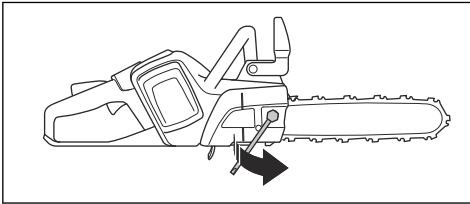

- Lift the front of the guide bar and turn the chain tensioning screw. Use a wrench.
- Tighten the saw chain until it is tight against the guide bar.

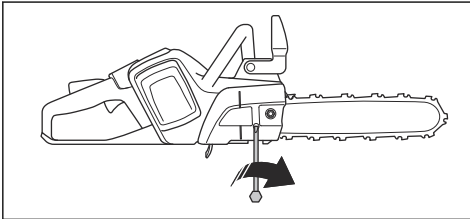

- Tighten the bar nut(s) using the wrench. Lift the front of the guide bar at the same time.

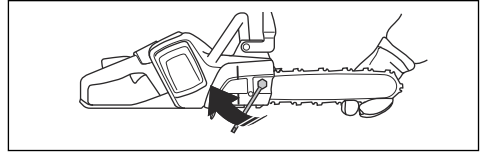

- Make sure you can pull the saw chain around freely by hand and that it does not hang from the bottom of the guide bar.

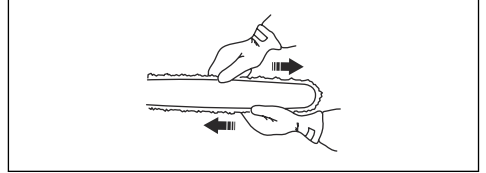

- Do a check of the chain tension frequently, until the saw chain is run-in.
- Do a check of the chain tension regularly to keep good cutting performance and a long life.

Note: The position of the chain tensioning screw is not the same on all models. See *Product overview on page 2* to find out where it is on your product.

To do a check of the saw chain lubrication

Do a check of the saw chain lubrication each third battery charge.

- Start the product and let it run at 3/4 power. Hold the bar approximately 20 cm (8 inches) above a light coloured surface.
- If the saw chain lubrication is correct, you will see a clear line of oil on the surface after 1 minute.



- If the saw chain lubrication is not correct, do the following checks.

- a) Do a check of the oil channel in the guide bar to make sure that it is not blocked. Clean if necessary.

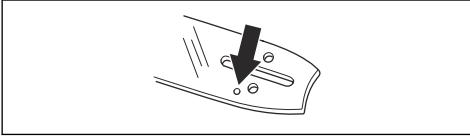

- b) Do a check of the groove in the edge of the guide bar to make sure that it is clean. Clean if necessary.

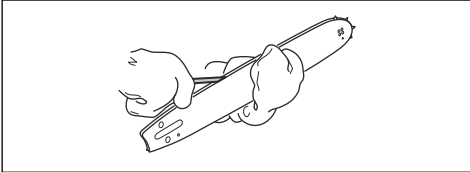

- c) Make sure that the bar tip sprocket turns freely and that the lubricating hole in the guide bar tip sprocket is not blocked. Clean and lubricate if necessary.



4. If the saw chain lubrication does not work after following the steps above, speak to your servicing dealer.

Chain drive sprocket

The drive system has a drive sprocket.

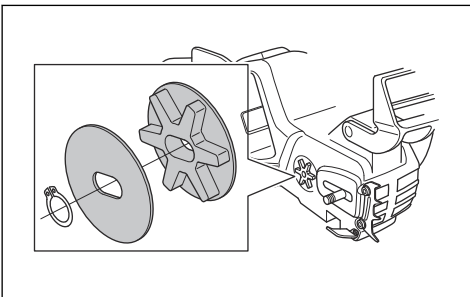

Do the following maintenance on the chain drive sprocket:

- Regularly do a check of the degree of wear on the drive sprocket. Replace the chain drive sprocket if there is too much wear.
- Replace the drive sprocket when you replace the saw chain.

To examine the cutting equipment for wear

Do a check of the saw chain daily.

1. Make sure that there are no cracks in rivets and links. Replace if necessary.

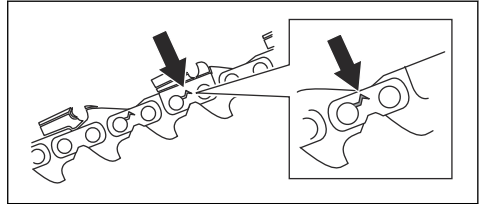

2. Examine if the saw chain is rigid. Replace if necessary.
3. Compare the saw chain with a new saw chain to examine if the rivets and links are worn. Replace the saw chain when the length of the cutting teeth has worn down to 4 mm/ 0.16 in.

To do a check of the guide bar

Do a check of the guide bar regularly.

1. Examine if there are burrs on the edges of the guide bar. Remove burrs with a file if necessary.

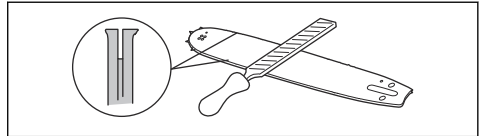

2. Examine the groove in the guide bar for wear. Replace the guide bar if necessary.

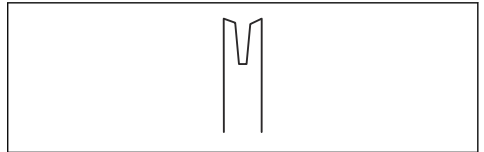

3. Examine if the guide bar tip is rough or very worn. Hollow shapes on the guide bar tip is a result of bad saw chain tension.

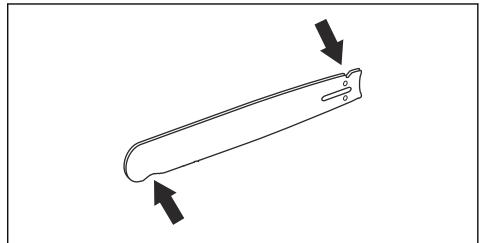

4. Turn the guide bar daily to extend its life cycle.

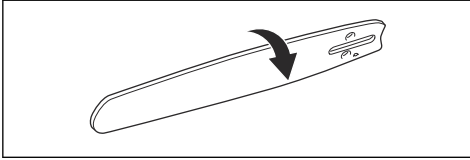

Maintenance schedule



WARNING: Remove the battery before you do maintenance.

The following is a list of the maintenance steps that you must do on the product. See *Maintenance on page 23* for more information.

Maintenance	Before use	Weekly	Monthly
Clean the external parts of the product.	X		
Make sure that the power trigger and the power trigger lockout function correctly from a safety point of view.	X		
Clean the chain brake and make sure that it operates safely. Make sure that the chain catcher is not damaged. Replace it if necessary.	X		
Turn the guide bar for more equal wear. Make sure that the lubrication hole in the guide bar is not clogged. Clean the bar groove.	X		
Make sure that the cutter and cutter guard have no cracks and that they are not damaged. Replace the cutter or cutter guard if they have cracks or if they have been exposed to impact.	X		
Make sure that the guide bar and saw chain have sufficient oil.	X		
Do a check of the saw chain. Look for cracks and make sure that the saw chain is not rigid or unusually worn. Replace if necessary.	X		
Sharpen the saw chain. Do a check of its tension and condition. Do a check for wear on the drive sprocket and replace is necessary.	X		
Clean the air inlet on the product.	X		
Make sure that the screws and nuts are tight.	X		
Make sure that the keypad works correctly and that it is not damaged.	X		
Use a file to remove burrs from the edges of the guide bar.		X	
Do a check of the connections between the battery and the product. Do a check of the connection between the battery and the battery charger.			X
Empty and clean the oil tank.			X
Blow through the product and battery cooling slots gently with compressed air.			X

Troubleshooting

Keypad

Possible fault codes on the keypad of the product.

LED display	Possible faults	Possible action
Warning indicator flashing.	Chain brake engaged.	Pull back the front hand guard to release the chain brake.
	Temperature deviation.	Allow the product to cool down.
	Overload. Cutting attachment jammed.	The cutting attachment is jammed. Release the cutting attachment.
	The power trigger and the activate button are pressed at the same time.	Release the power trigger and the product is active.
Green activate LED flashing.	Low battery voltage.	Charge the battery.
Warning indicator lit.	Service.	Turn to your servicing dealer.

Battery

Problem	Possible faults	Possible solution
Green LED flashes.	Low battery voltage.	Charge the battery.
Red error LED flashes.	The battery is empty.	Charge the battery.
	Temperature deviation.	Use the battery in temperatures between -10°C (14°F) and 40°C (104°F).
	Overvoltage.	Remove the battery from the battery charger.
Red error LED comes on.	Cell difference is too much (1V).	Speak to your servicing dealer.

Battery charger

LED display	Possible faults	Possible action
Warning indicator flashing.	Temperature deviation.	Use the battery in surroundings where temperatures are between 5°C/41°F and 40°C/104°F.
Warning indicator lit.		Turn to your servicing dealer.

Transportation, storage and disposal

Transportation and storage

- The supplied Li-ion batteries obey the Dangerous Goods Legislation requirements.
- Obey the special requirement on package and labels for commercial transportations, including by third parties and forwarding agents.
- Speak to a person with special training in dangerous material before you send the product. Obey all applicable national regulations.

- Use tape on open contacts when you put the battery in a package. Put the battery in the package tightly to prevent movement.
- Remove the battery for storage or transportation.
- Put the battery and the battery charger in a space that is dry and free from moisture and frost.
- Do not keep the battery in an area where static electricity can occur. Do not keep the battery in a metal box.

- Put the battery in storage where the temperature is between 5 °C (41 °F) and 25 °C (77 °F) and away from open sunlight.
- Put the battery charger in storage where the temperature is between 5 °C (41 °F) and 45 °C (113 °F) and away from open sunlight.
- Charge the battery 30% to 50% before you put it in storage for long periods.
- Put the battery charger in storage in a space that is closed and dry.
- Keep the battery away from the battery charger during storage. Do not let children and other not approved persons to touch the equipment. Keep the equipment in a space that you can lock.
- Clean the product and do a full servicing before you put the product in storage for a long time.
- Use the transportation guard on the product to prevent injuries or damage on the product during transportation and storage.

- Attach the product safely during transportation.

Disposal of the battery, battery charger and product

The symbol below means that the product is not domestic waste. Recycle it at a recycling station for electrical and electronic equipment. This helps to prevent damage to the environment and to persons.

Speak to local authorities, domestic waste service or your dealer for more information.

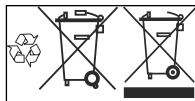

Note: The symbol shows on the product or package of the product.

Technical data

Technical data

	330i	535i XP
Motor		
Type	BLDC (brushless) 36V	BLDC (brushless) 36V
Features		
Low energy mode	savE	savE
Lubrication system		
Type of oil pump	Automatic	Automatic
Oil tank capacity, US Pint/litre	0.42/0.2	0.42/0.2
Weight		
Chainsaw without battery, guide bar, saw chain and empty chain oil tank, lb/kg	5.5/2.5	5.3/2.4
Water protection level		
IPX4	Yes	Yes
Saw chain/guide bar		
Recommended bar lengths, inch/cm	10-14/25-35	10-14/25-35
Usable cutting length, inch/cm	9-13/23-33	9-13/23-33
Type of drive sprocket/number of teeth	Spur/6	Spur/6
Maximum chain speed / (savE), m/s	15 (12)	20 (15)

Accessories

Recommended cutting equipment for USA

Following is a list of recommended cutting equipment for Husqvarna 330i and 535i XP. This model equipped with either of the listed guide bar and saw chain combination(s), fulfills the requirements according to UL 60745-1 and UL 60745-2-13.

Chainsaw models Husqvarna 330i and 535i XP met the kickback performance requirements of UL 60745-2-13 when tested with the combinations of bars and saw chains listed below. The saw chain Husqvarna H38 is also classified as a low kickback saw chain since it meets the requirements for low kickback saw chain outlined in UL 60745-2-13. We recommend to use only the listed combinations of bars and saw chains for chainsaw models Husqvarna 330i and 535i XP. Other chainsaw models may not meet the kickback requirements when equipped with the listed bar and saw chain combinations.







Guide bar and saw chain combinations

Following is a list of recommended cutting equipment for Husqvarna 330i and 535i XP. The listed combination(s)

Guide bar				Saw chain	
Length, in	Chain pitch, in	Gauge, in	Max. nose radius	Type	Length, drive links (no.)
10	3/8	0.043	7T	Husqvarna H38	40
12			9T		45
14					52

Filing equipment and filing angles

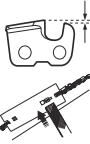
Using Husqvarna file gauge will give you the correct filing angles. We recommend you to always use a Husqvarna file gauge to restore the sharpness of the

							
38	11/64 in/4,5 mm	90°	30°	0°	0.025 in/ 0,65 mm	5056981-03	5795588-01

of powerhead, guide bar and saw chain meet all requirements outlined in Canadian Standards Association Z62.1-11 (Chain saws) and Z62.3-11 (Chain Saw Kickback).

Furthermore the saw chain Husqvarna H38 is evaluated and listed as a Type C Low Kickback Saw chain according to the provisions in Z62.3-11.

Kickback information

The guide bar nose radius is determined by either the maximum number of teeth in the nose sprocket or the corresponding maximum nose radius of a solid bar.

As we are listing the maximum guide bar nose radius, you may use a guide bar with smaller nose radius than in our list. For guide bars of the same length, all sprocket-nose guide bars of the same pitch and having the same number of sprocket teeth may be considered to have equivalent kickback energy.

The following cutting equipment is approved for the models Husqvarna 330i and 535i XP.

saw chain. The part numbers are given in the table below.

If you do not know which saw chain you have on your product, turn to your servicing dealer.

Approved batteries for the product

Battery	BLi200
Type	Lithium-ion
Battery capacity, Ah	5.2
Nominal voltage, V	36
Weight, lb/kg	2.9/1.3

Approved battery chargers for the product

Battery charger	QC330
Mains voltage, V	100-240
Frequency, Hz	50-60
Power, W	330

Warranty

AMERICAN STANDARD SAFETY PRECAUTIONS

SAFETY PRECAUTIONS FOR CHAIN SAW USERS

(ANSI B175.1-2012 Annex C)

KICKBACK SAFETY PRECAUTIONS



WARNING: Kickback may occur when the nose or tip of the guide bar touches an object, or when the wood closes in and pinches the saw chain in the cut.

Tip contact in some cases may cause a lightning fast reverse reaction, kicking the guide bar up and back towards the operator.

Pinching the saw chain along the top of the guide bar may push the guide bar rapidly back towards the operator.

Either of these reactions may cause you to lose control of the saw which could result in serious personal injury.

Do not rely exclusively upon the safety devices built into your saw. As a chain saw user, you should take several steps to keep your cutting jobs free from accident or injury.

With a basic understanding of kickback, you can reduce or eliminate the element of surprise. Sudden surprise contributes to accidents.

Keep a good firm grip on the saw with both hands, the right hand on the rear handle, and the left hand on the front handle, when the engine is running. Use a firm grip with thumbs and fingers encircling the chain saw handles. A firm grip will help you reduce kickback and maintain control of the saw. Don't let go.

Make sure that the area in which you are cutting is free from obstacles. Do not let the nose of the guide bar contact a log, branch, or any other obstacle which could be hit while you are operating the saw.

Cut at high engine speeds.

Do not overreach or cut above shoulder height.

Follow manufacturer's sharpening and maintenance instructions for the saw chain.

Only use replacement bars and chains specified by the manufacturer or the equivalent.

OTHER SAFETY PRECAUTIONS



WARNING: Do not operate a chain saw with one hand! Serious injury to the operator, helpers, bystanders or any combination of these persons may result from one-handed

operation. A chain saw is intended for two-handed use.

Do not operate a chain saw when you are fatigued.

Use safety footwear; snug-fitting clothing, protective gloves, and eye, hearing and head protection devices.

Use caution when handling fuel. Move the chain saw at least 10 feet (3 m) from the fueling point before starting the engine.

Do not allow other persons to be near the chain saw when starting or cutting with the chain saw. Keep bystanders and animals out of the work area.

Do not start cutting until you have a clear work area, secure footing and a planned retreat path from the falling tree.

Keep all parts of your body away from the saw chain when the engine is running.

Before you start the engine, make sure that the saw chain is not contacting anything.

Carry the chain saw with the engine stopped, the guide bar and saw chain to the rear, and the muffler away from your body.

Do not operate a chain saw that is damaged, improperly adjusted, or not completely and securely assembled. Be sure that the saw chain stops moving when the throttle control trigger is released.

Shut off the engine before setting the chain saw down.

Use extreme caution when cutting small size brush and saplings because slender material may catch the saw chain and be whipped toward you or pull you off balance.

When cutting a limb that is under tension be alert for springback so that you will not be struck when the tension in the wood fibers is released.

Keep handles dry, clean and free of oil or fuel mixture.

Operate the chain saw only in well-ventilated areas.

Do not operate a chain saw in a tree unless you have been specifically trained to do so.

Do not operate a chain saw above shoulder height.

All chain saw service, other than the items listed in the operator's/owner's safety and maintenance instructions, should be performed by competent chain saw service personnel. (For example, if improper tools are used to remove the flywheel or if an improper tool is used to hold the flywheel in order to remove the clutch, structural damage to the flywheel could occur and subsequently cause the flywheel to burst.)

When transporting your chain saw, use the appropriate guide bar guard.

Note: This Annex is intended primarily for the consumer or occasional user.



www.husqvarna.com

Original instructions

1140988-95



2018-11-23