



Operator's manual
HUSQVARNA AUTOMOWER®
310/315/315X



EN, English

Read the operator's manual carefully and make sure that you understand the instructions before you use the product.

Contents

1 Introduction	
1.1 Introduction.....	3
1.2 Product overview Automower® 310/315/315X.....	4
1.3 Symbols on the product.....	5
1.4 Symbols on the display.....	5
1.5 Symbols on the battery.....	6
1.6 General manual instructions.....	6
1.7 Menu structure overview - 1.....	7
1.8 Menu structure overview - 2.....	8
1.9 Display.....	9
1.10 Keypad.....	9
2 Safety	
2.1 Safety information.....	10
2.2 Safety definitions.....	11
2.3 Safety instructions for operation.....	11
3 Installation	
3.1 Introduction - Installation.....	15
3.2 Main components for installation.....	15
3.3 General preparations.....	15
3.4 Before the installation of the wires.....	15
3.5 Installation of the product.....	20
3.6 To put the wire into position with stakes...	22
3.7 To bury the boundary wire or the guide wire.....	23
3.8 To extend the boundary wire or the guide wire.....	23
3.9 After the installation of the product.....	23
3.10 To do the product settings.....	24
4 Operation	
4.1 Main switch.....	36
4.2 To start the product.....	36
4.3 Operating mode Start.....	36
4.4 Operating mode Park.....	37
4.5 To stop the product.....	37
4.6 To switch off the product.....	37
4.7 Schedule and Standby.....	37
4.8 To charge the battery.....	38
4.9 Adjust the cutting height.....	39
5 Maintenance	
5.1 Introduction - maintenance.....	40
5.2 Clean the product.....	40
5.3 Replace the blades.....	41
5.4 Battery.....	41
5.5 Winter service.....	42
6 Troubleshooting	
6.1 Introduction - troubleshooting.....	43
6.2 Fault messages.....	43
6.3 Information messages.....	48
6.4 Indicator lamp in the charging station.....	49
6.5 Symptoms.....	50
6.6 Find breaks in the loop wire.....	51
7 Transportation, storage and disposal	
7.1 Transportation.....	54
7.2 Storage.....	54
7.3 Disposal.....	54
8 Technical data	
8.1 Technical data.....	55
8.2 Registered trademarks.....	57
9 Warranty	
9.1 Warranty terms.....	58
10 EC Declaration of Conformity	
10.1 EC Declaration of Conformity.....	59

1 Introduction

1.1 Introduction

Serial number:

PIN code:

The serial number is on the product rating plate and on the product carton.

- Use the serial number to register your product on www.husqvarna.com.

1.1.1 Support

For support about the product, speak to your Husqvarna servicing dealer.

1.1.2 Product description

Note: Husqvarna regularly updates the appearance and function of the products. Refer to *Support on page 3*.

The product is a robotic lawn mower. The product has a battery power source and cuts the grass automatically. It continuously alternates between mowing and charging. The movement pattern is random, which means that the lawn is mowed evenly and with less wear. The boundary wire and the guide wire controls the movement of the product within the work area. Sensors in the product senses when it is approaching the boundary wire. The front of the product always passes the boundary wire by a specific distance before the product turns around. When the product hits an obstacle or approaches the boundary wire the product selects a new direction.

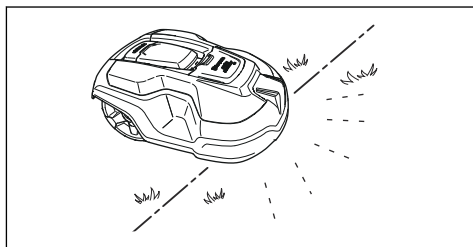

The operator selects the operation settings with the keys on the keypad. The display shows the selected and possible operation settings, and the operation mode of the product.

1.1.2.1 Mowing technique

The product is emission free, easy to use and saves energy. The frequent cutting technique improves the grass quality and decreases the use of fertilizers. Collection of grass is not necessary.

1.1.2.2 Find the charging station

The product operates until the battery state of charge is low. Then it follows the guide wire to the charging station. The guide wire is laid from the charging station towards, for instance, a remote part of the work area or through a narrow passage. The guide wire is connected with the boundary wire and makes it much easier and faster for the product to find the charging station.

1.1.2.3 Automower® Connect

Automower® Connect is a mobile application that makes it possible to select the operation settings remotely. Refer to *Automower® Connect app on page 33*.

1.2 Product overview Automower® 310/315/315X

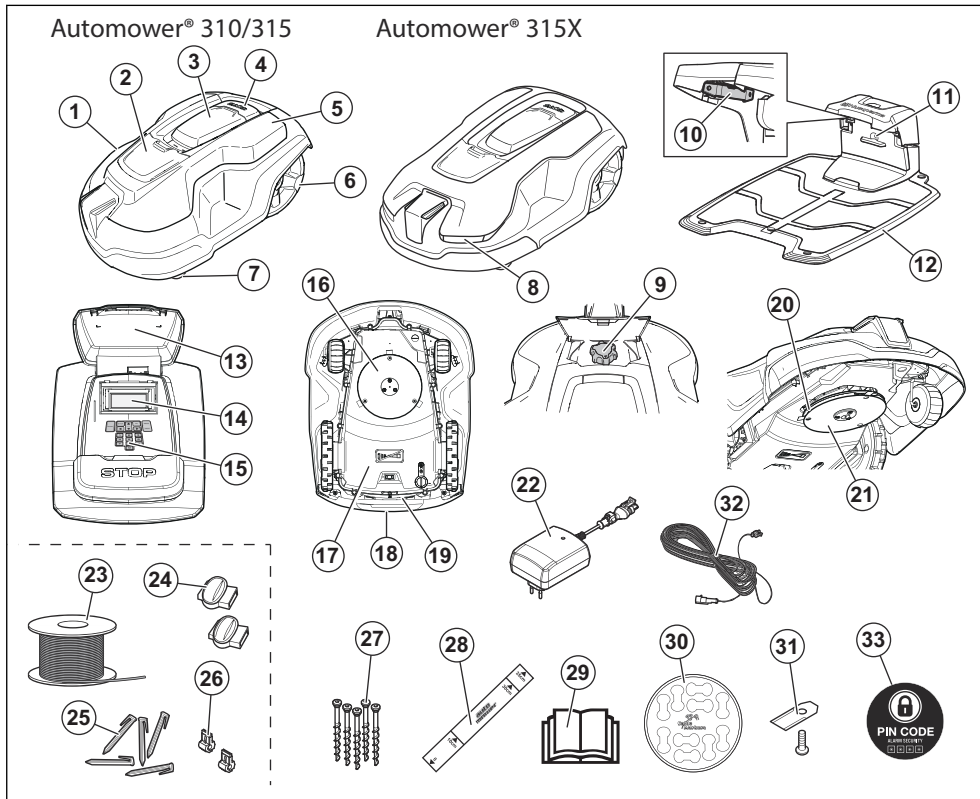

The numbers in the figure represent:

- | | |
|---|--|
| 1. Body | 13. Rating plate (incl. product identification code) |
| 2. Hatch to cutting height adjustment | 14. Display |
| 3. Hatch to display and keypad | 15. Keypad |
| 4. Stop button | 16. Cutting system |
| 5. Replaceable cover | 17. Chassis box with electronics, battery and motors |
| 6. Rear wheels | 18. Handle |
| 7. Front wheels | 19. Main switch |
| 8. Headlights | 20. Blade disc |
| 9. Cutting height adjustment | 21. Skid plate |
| 10. Contact plates | 22. Power supply (the appearance may differ depending on market) |
| 11. LED for operation check of the charging station and boundary wire | |
| 12. Charging station | |

23. Loop wire for boundary loop and guide wire¹
24. Couplers for loop wire²
25. Stakes³
26. Connector for the loop wire⁴
27. Screws for securing the charging station
28. Measurement gauge for help when installing the boundary wire (the measurement gauge is broken loose from the box)
29. Operator's Manual and Quick Guide
30. Cable markers
31. Extra blades
32. Low voltage cable
33. Alarm decal

1.3 Symbols on the product

These symbols can be found on the product. Study them carefully.



WARNING: Read the user instructions before operating the product.



WARNING: Disable the product before working on or lifting the product.



WARNING: Keep a safe distance from the product when operating. Keep your hands and feet away from the rotating blades.



WARNING: Do not ride on the product. Never put your hands or feet close to or under the product.

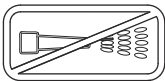

Never use a high-pressure washer or even running water to clean the product.

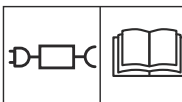

Use a detachable power supply as defined on the rating label next to the symbol.

 This product conforms to the applicable EC Directives.



Noise emission to surroundings. The product's emissions are set out in *Technical data on page 55* and on the rating plate.



It is not permitted to dispose this product as normal household waste. Ensure that the product is recycled in accordance with local legal requirements.



The chassis contains components which are sensitive to electrostatic discharge (ESD). The chassis must also be resealed in a professional manner. For these reasons the chassis shall only be opened by authorized service technicians. A broken seal can result in the entire or parts of the guarantee no longer being valid.



The low voltage cable must not be shortened, extended or spliced. Do not use a trimmer nearby the low voltage cable. Be careful when trimming edges where the cables are placed.

1.4 Symbols on the display



The schedule function controls when the product cuts the lawn.



The security function lets the operator select between 3 security levels.

¹ Is a part of the Installation kit which is purchased separately.

² Refer to note 1

³ Refer to note 1

⁴ Refer to note 1



The messages function shows error messages and possible cause for the problems.



The weather timer function automatically adapts the cutting intervals to the grass growth.



The installation function for manual settings for the installation.



The settings function is where the general settings for the products are set.



The accessories function is where all settings for the accessories for the product are set.



The product will not cut the grass do to the schedule function.



The product overrides the schedule function.



The battery indicator shows the charge level of the battery. When the product charges the symbol flashes.



The product is put in the charging station but do not charge the battery.



The product is set in ECO-mode.



For Automower® Connect and Connect@Home. Bluetooth® wireless communication with your mobile device.



The GPS-supported navigation is active. Flashes as it collects GPS information. Automower® 315X



The GPS-supported navigation is not active. Automower® 315X

1.5 Symbols on the battery



Read the user instructions.



Do not discard the battery into fire and do not expose the battery to a heat source.



Do not immerse the battery into water.

1.6 General manual instructions

The following system is used in the Operator's Manual to make it easier to use:

- Text written in *italics* is a text that is shown in the display or is a reference to another section in the Operator's Manual.
- Text written in **bold** is one of the buttons on the product.
- Text written in *UPPERCASE* and *italics* refer to the different operating modes available in the product.

1.7 Menu structure overview - 1

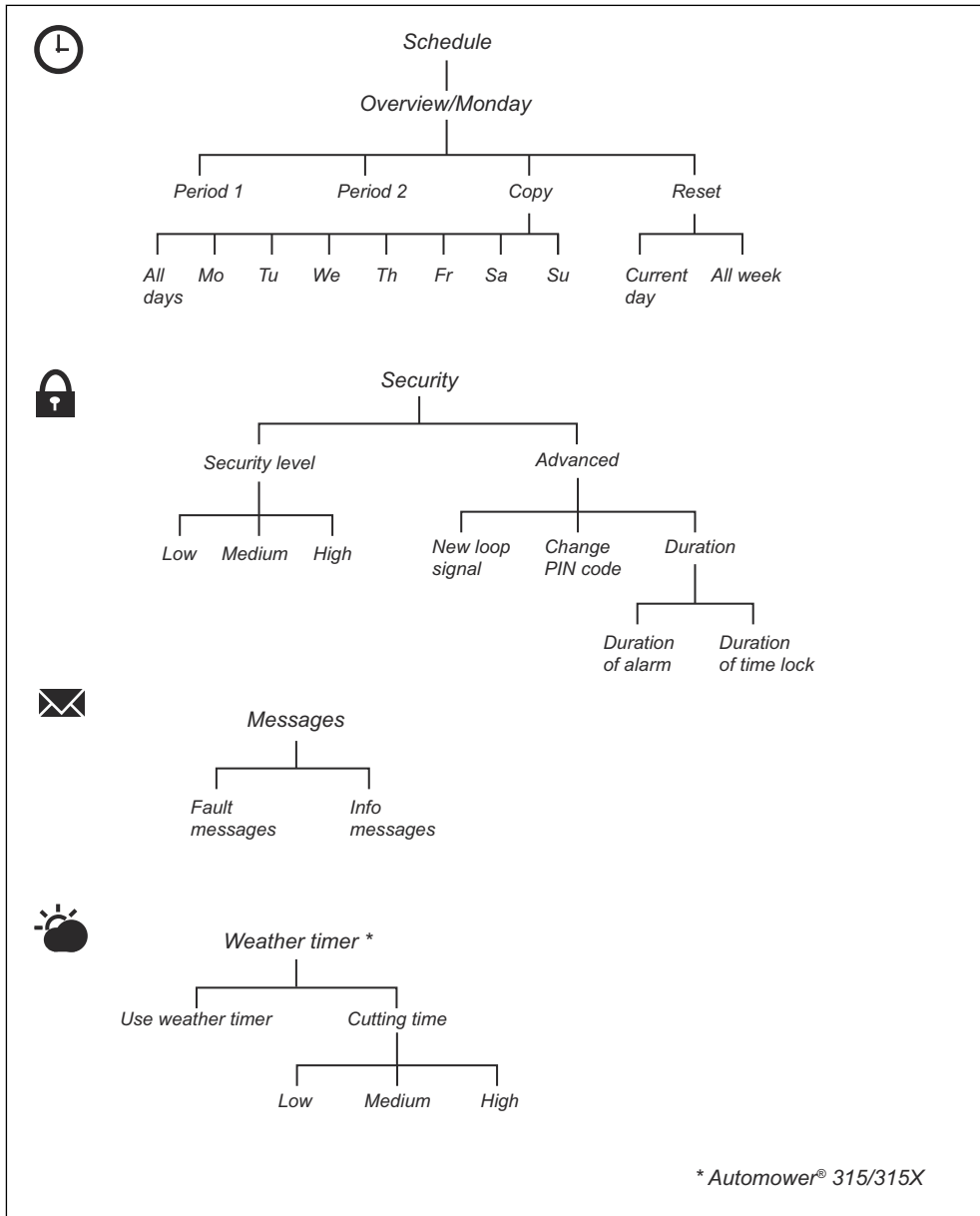

1.8 Menu structure overview - 2

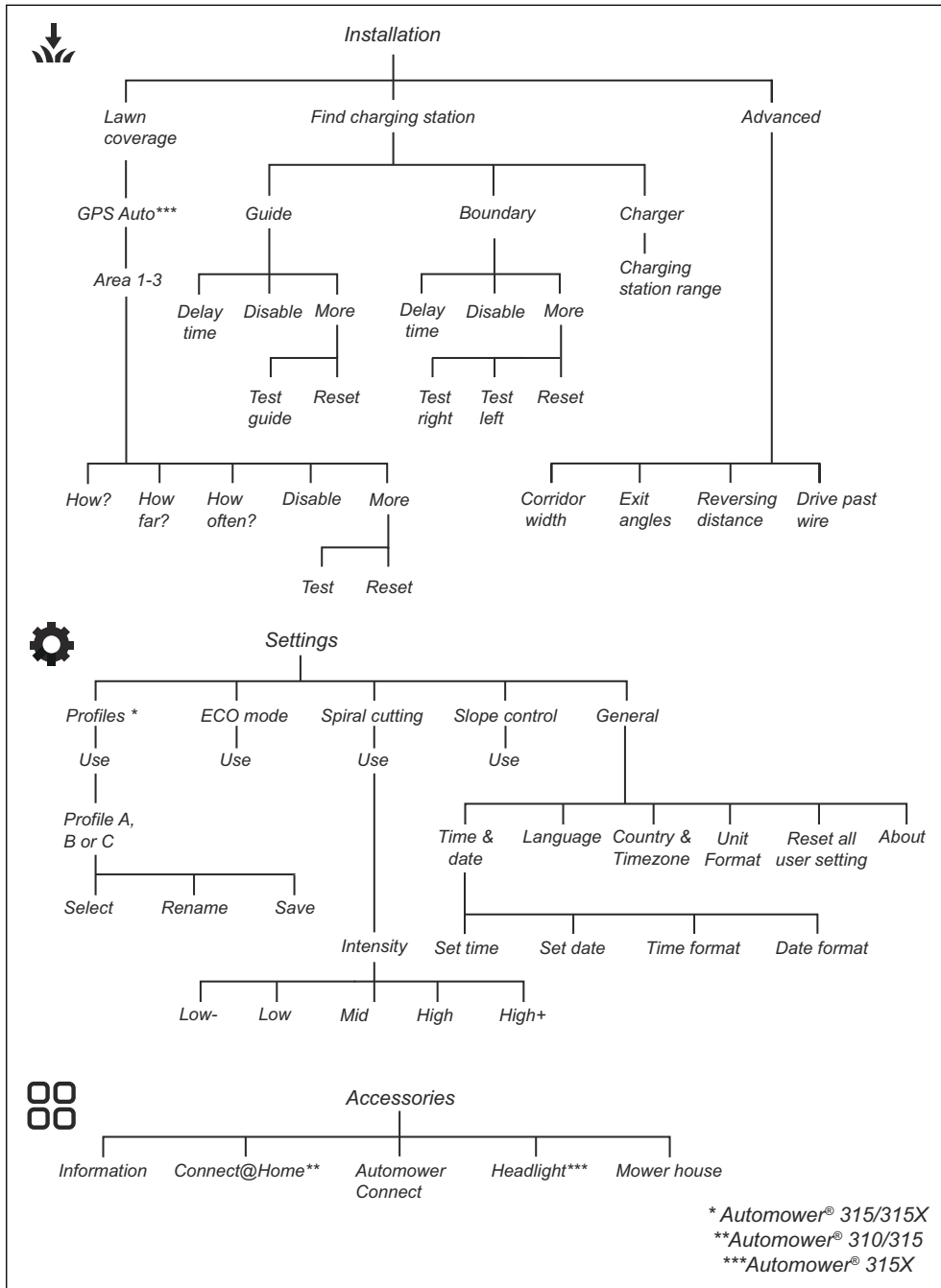

1.9 Display

The display on the product shows information and settings of the product.

To access the display, push the **STOP** button.

1.10 Keypad

Use the keypad on the product to navigate in the menu. To access the keypad, push the **STOP** button.

- Use the **START** button (A) to start the operation of the product.
- Use the **BACK** button (B) to move up in the menu lists.
- Use the **arrow** buttons (C) to navigate in the menu.
- Use the **OK** button (D) to confirm the settings you select in the menus.
- Use the **MENU** button (E) to go to the main menu.
- Use the **PARK** button (F) to send the product to the charging station.
- Use the **number** buttons (G) to enter PIN code, time and date.

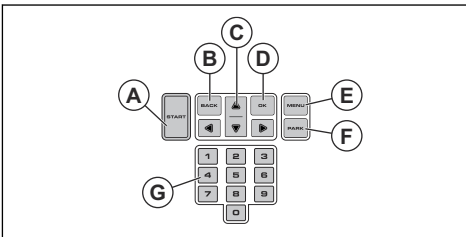

2.1 Safety information

2.1.1 IMPORTANT. READ CAREFULLY BEFORE USE. KEEP FOR FUTURE REFERENCE

The operator is responsible for accidents or hazards occurring to other people or property.

This appliance is not intended for use by persons (including children) with reduced physical, sensory or mental capabilities (that could affect a safe handling of the product), or lack of experience and knowledge, unless they have been given supervision or instruction concerning use of the appliance by a person responsible for their safety.

This appliance can be used by children aged from 8 years and above and persons with reduced physical, sensory or mental capabilities or lack of experience and knowledge if they have been given supervision or instruction concerning use of the appliance in a safe way and understand the hazards involved. Local regulations may restrict the age of the operator. Cleaning and maintenance shall not be made by children without supervision.

Never connect the power supply to an outlet if the plug or cord is damaged. Worn or damaged cord increase the risk of electric shock.

Only charge the battery in the included charging station. Incorrect use may result in electric shock, overheating or leaking of corrosive liquid from the battery. In the event of leakage of electrolyte, flush with water/neutralizing agent. Seek medical help if it comes in contact with the eyes.

Use only original batteries recommended by the manufacturer. Product safety cannot be guaranteed with other than original batteries. Do not use non-rechargeable batteries.

The appliance must be disconnected from the supply mains when removing the battery.



WARNING: The product can be dangerous if used incorrectly.



CAUTION: Used if there is a risk of damage to the product, other materials or the adjacent area if the instructions in the manual are not obeyed.



WARNING: Do not use the product when persons, especially children, or animals are in the work area.

Note: Used to give more information that is necessary in a given situation.

2.3 Safety instructions for operation

2.3.1 Use

- The product may only be used with the equipment recommended by the manufacturer. All other types of use are incorrect. The manufacturer's instructions with regard to operation/maintenance must be followed precisely.
- Warning signs shall be placed around the work area of the product if it is used in public areas. The signs shall have the following text: **Warning! Automatic lawnmower! Keep away from the machine! Supervise children!**



WARNING: Keep your hands and feet away from the rotating blades. Never put your hands or feet close to or under the product when the motor is running.

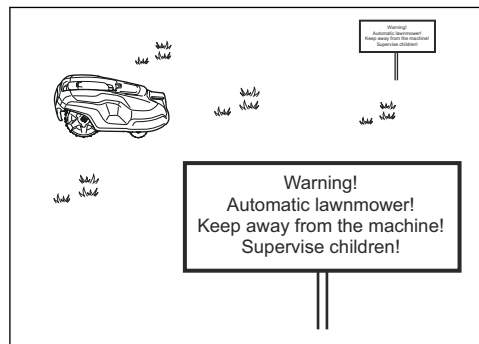

WARNING: In the event of an injury or accident seek medical help.

- Use the operating mode *Park* or switch off the product when persons, especially children, or animals, are in the work area. It is recommended to program the product for use during hours when the area is free from activity, e.g. at night. Refer to *Schedule on page 24*. Consider that certain animals, e.g. hedgehogs, are active at night. They can potentially be harmed by the product.

2.2 Safety definitions

Warnings, cautions and notes are used to point out specially important parts of the manual.



WARNING: Used if there is a risk of injury or death for the operator or bystanders if the instructions in the manual are not obeyed.

- The product may only be operated, maintained and repaired by persons that are fully conversant with its special characteristics and safety regulations. Please read the Operator's Manual carefully and make sure you understand the instructions before using the product.
- It is not permitted to modify the original design of the product. All modifications are made at your own risk.
- Check that there are no foreign objects such as stones, branches, tools or toys on the lawn. If the blades hit foreign objects the blades can be damaged. Always switch off the product with the main switch before clearing a blockage. Inspect the product for damage before starting the product again.

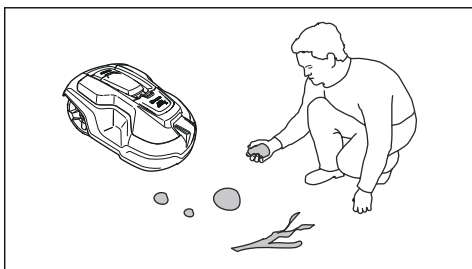

- If the product starts to vibrate abnormally, switch off the product with the main switch. Examine the product for damages before you start the product again.
- Start the product according to the instructions. When the product is switched on, make sure to keep your hands and feet away from the rotating blades. Never put your hands and feet under the product.
- Never touch moving hazardous parts, such as the blade disc, before it has come to a complete stop.
- Never lift up the product or carry it around when it is switched on.
- Do not let persons who do not know how the product works and behaves use it.
- The product must never be allowed to collide with persons or other living creatures. If a person or other living creature comes in the product's way it shall be stopped immediately. Refer to *To stop the product on page 37*.
- Do not put anything on top of the product or its charging station.

- Do not allow the product to be used with a defective guard, blade disc or body. Neither should it be used with defective blades, screws, nuts or cables. Never connect a damaged cable, or touch a damaged cable before it is disconnected from the supply.
- Do not use the product if the **Main switch** does not work.
- Always switch off the product using the **Main switch** when the product is not in use. The product can only start when the **Main switch** has been switched on and the correct PIN code has been entered.
- Husqvarna® does not guarantee full compatibility between the product and other types of wireless systems such as remote controls, radio transmitters, hearing loops, underground electric animal fencing or similar.
- Metal objects in the ground (for example reinforced concrete or anti-mole nets) can result in a stoppage. The metal objects can cause interference with the loop signal which then can lead to a stoppage.
- Operation and storage temperature is 0-50 °C / 32-122 °F. Temperature range for charging is 0-45 °C / 32-113 °F. Too high temperatures might cause damage to the product.

2.3.2 Battery safety



WARNING: Lithium-ion batteries can explode or cause fire if disassembled, short-circuited, exposed to water, fire, or high temperatures. Handle carefully, do not dismantle, open the battery or use any type of electrical/mechanical abuse. Avoid storage in direct sunlight.

For more information about the battery, refer to *Battery on page 41*

2.3.3 How to lift and move the product



WARNING: The product must be switched off before lifting it. The product is disabled when the **Main switch** is in position 0.



CAUTION: Do not lift the product when it is parked in the charging station. It can damage the charging station and/or the product. Push **STOP** and pull the product out of the charging station before lifting it.

To safely move from or within the work area:

1. Push the **STOP** button to stop the product.

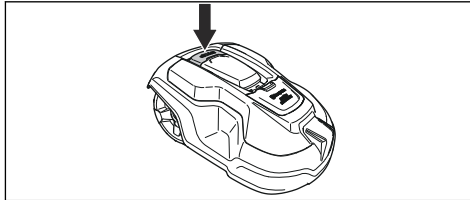

2. Set the main switch in position 0.

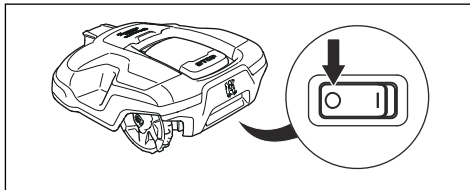

3. Carry the product by the handle with the blade disc away from the body.

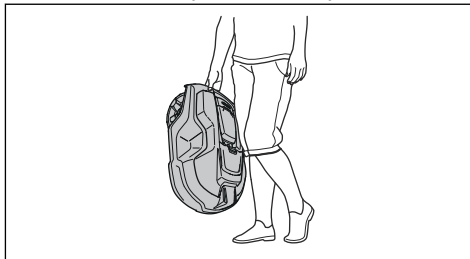

2.3.4 Maintenance



WARNING: The product must be switched off before any maintenance is done. Use the plug to disconnect the charging station before any cleaning or maintenance of the charging station or the loop wire.

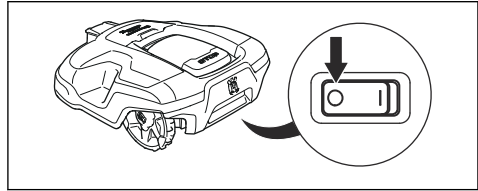

WARNING: Use the plug to disconnect the charging station before any cleaning or maintenance of the charging station or the loop wire.



CAUTION: Never use a high-pressure washer or even running water to clean the product. Never use solvents for cleaning.

Inspect the product weekly and replace any damaged or worn parts. Refer to *Maintenance on page 40*.

2.3.5 In the event of a thunderstorm

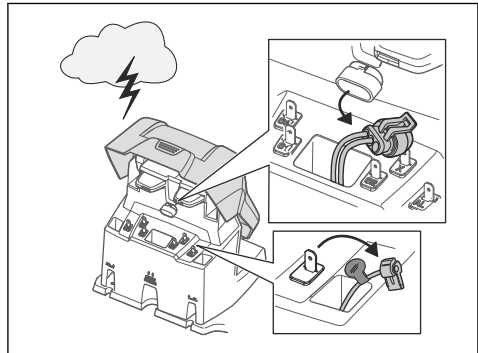

To reduce the risk of damage to electrical components in the product and the charging station, we recommend that all connections to the charging station are disconnected (power supply, boundary wire and guide wire) if there is a risk of a thunderstorm.

1. Mark the wires to simplify reconnecting. The charging station's connections are marked AR, AL and GUIDE.
2. Disconnect all connected wires and the power supply.
3. Connect all the wires and the power supply if there is no longer a risk of thunder. It is

important that each wire is connected to the right place.

3 Installation

3.1 Introduction - Installation



WARNING: Read and understand the safety chapter before you install the product.



CAUTION: Use original spare parts and installation material.

Note: Refer to www.husqvarna.com for more information about installation.

3.2 Main components for installation

The installation involves the following components:

- A robotic lawn mower that mows the lawn automatically.
- A charging station, which has 3 functions:
 - To send control signals along the boundary wire.
 - To send control signals along the guide wire so that the product can follow the guide to specific remote areas in the garden and can find its way back to the charging station.
 - To charge the product.
- A power supply, which is connected to the charging station and a 100-240V wall socket.
- Loop wire, which is laid around the work area and around objects and plants that the product must not run into. The loop wire is used both as boundary wire and guide wire.

3.3 General preparations



CAUTION: Holes with water in the lawn can cause damage to the product.

Note: Read through the Installation chapter before beginning the installation. How the installation is done affects how the product

performs. It is therefore important to plan the installation carefully.

- Make a blueprint of the work area and include all obstacles. This makes it easier to see the ideal positions for the charging station, the boundary wire and the guide wire.
- Make a mark on the blueprint where to put the charging station, the boundary wire and the guide wire.
- Make a mark on the blueprint where the guide wire connects to the boundary wire. Refer to *To install the guide wire on page 22*.
- Fill in holes in the lawn.
- Cut the grass before you install the product. Make sure that the grass is maximum 10 cm / 3.9 in.

Note: The first weeks after installation the perceived sound level when cutting the grass may be higher than expected. When the product has cut the grass for some time, the perceived sound level is much lower.

3.4 Before the installation of the wires

You can select to attach the wires with stakes or bury them. You can use the 2 procedures for the same work area.

- Bury the boundary wire or the guide wire if you are going to use a dethatcher on the work area. If not, attach the boundary wire or guide wire with stakes.

3.4.1 To examine where to put the charging station

- Keep a minimum 3 m / 10 ft. of free space in front of the charging station. Refer to *To examine where to put the guide wire on page 19*.
- Keep a minimum of 1.5 m / 5 ft. of free space to the right and left of the center of the charging station.
- Put the charging station near a power outlet.
- Put the charging station on a level surface.

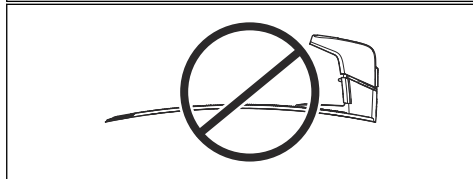
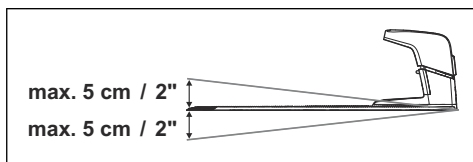

- Put the charging station in the lower section of the work area.
- Put the charging station in an area with protection from the sun.
- If the charging station is installed on an island, make sure to connect the guide wire to the island. Refer to *To make an island on page 18*.

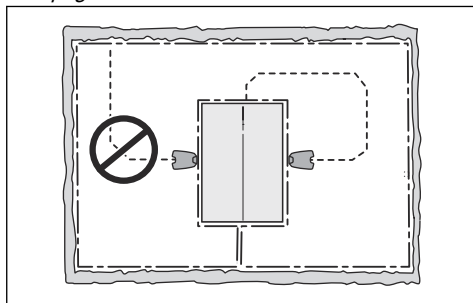

3.4.2 To examine where to put the power supply



WARNING: Do not cut or extend the low-voltage cable. There is a risk of electrical shock.



CAUTION: Make sure that the blades on the product do not cut the low-voltage cable.



WARNING: The power supply cable and extension cable must be outside the work area to avoid damage to the cables.



CAUTION: Do not put the low-voltage cable in a coil or below the charging station plate. The coil causes interference with the signal from the charging station.

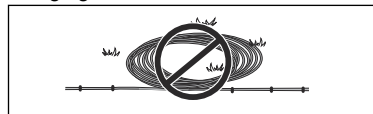

- Put the power supply in an area with a roof and protection from the sun and rain.
- Put the power supply in an area with good airflow.
- Use a residual-current device (RCD) when you connect the power supply to the power outlet.

Low-voltage cables of different lengths are available as accessories.

3.4.3 To examine where to put the boundary wire



CAUTION: If the work area is adjacent to water bodies, slopes, precipices or a public road, the boundary wire must have a protective wall. The wall must be minimum 15 cm / 6 in. in height.



CAUTION: Do not let the product operate on gravel.



CAUTION: Do not make sharp bends when you install the boundary wire.



CAUTION: For careful operation without noise, isolate all obstacles such as trees, roots and stones.

The boundary wire should be put as a loop around the work area. Sensors in the product senses when the product approaches the boundary wire, and the product selects another direction.

To make the connection easier between the guide wire and the boundary wire, it is

recommended to make an eyelet where the guide wire will be connected. Make the eyelet with approximately 20 cm / 8 in. of the boundary wire.

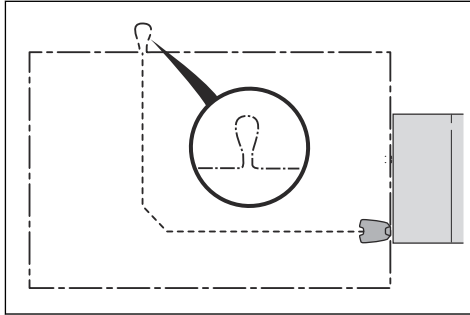

Note: Make a blueprint of the work area before you install the boundary wire and guide wire.

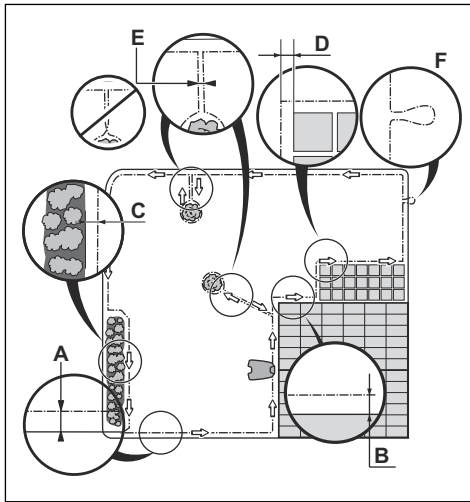

- Put the boundary wire around all of the work area (A). Adapt the distance between the boundary wire and obstacles.
- Put the boundary wire 35 cm / 14 in. (B) from an obstacle that is more than 5 cm / 2 in. high.

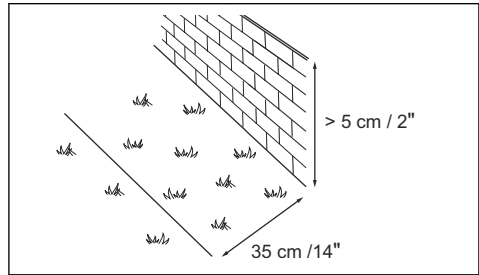

- Put the boundary wire 30 cm / 12 in. (C) from an obstacle that is 1-5 cm / 0.4-2 in. high.

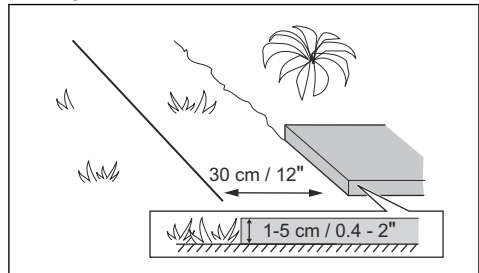

- Put the boundary wire 10 cm / 4 in. (D) from an obstacle that is less than 1 cm / 0.4 in. high.

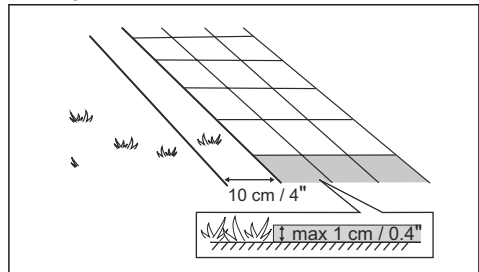

- If you have a paving stone path that is in level with the lawn, put the boundary wire below the paving stone.

Note: If the paving stone is minimum 30 cm / 12 in. wide, use the factory setting for the *Drive Past Wire* function to cut all the grass adjacent to the paving stone. Refer to *To set the Drive Past Wire function on page 30*.

- If you make an island, put the boundary wire that runs to and from the island near together (E). Put the wires in the same stake. Refer to *To make an island on page 18*.

- Make an eyelet (F) where the guide wire is to be connected to the boundary wire.

3.4.3.1 To put the boundary wire in a slope

The product can operate in 35% slopes. Slopes that are too steep must be isolated with the boundary wire. The gradient (%) is calculated as height per m. Example: 10 cm / 100 cm = 10%.

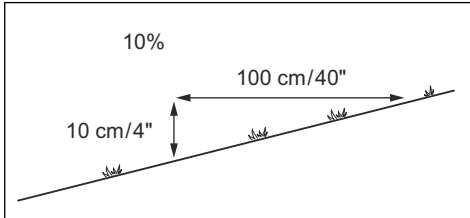

- For slopes steeper than 35% inside the work area, isolate the slope with boundary wire.
- For slopes steeper than 15% along the outer edge of the lawn, put the boundary wire 20 cm / 8 in. (A) from the edge.

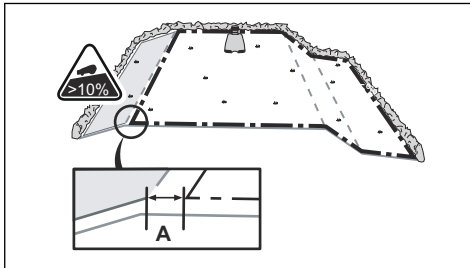

- For slopes adjacent to a public road, put a fence or a protective wall along the outer edge of the slope.
- Make sure that there is as much free area as possible to the left of the guide wire. The product moves on the left side of the guide wire, when you face the charging station.

3.4.3.2 Passages

A passage is a section that has boundary wire on each side and that connects 2 work areas. The passage must be a minimum of 60 cm / 24 in. between the boundary wire.

Note: If a passage is less than 2 m / 6.5 ft. wide, install a guide wire through the passage.

The product always runs to the left of the guide wire as seen facing the charging station. Make

sure that the guide wire has as much free area as possible to the left of the guide wire.

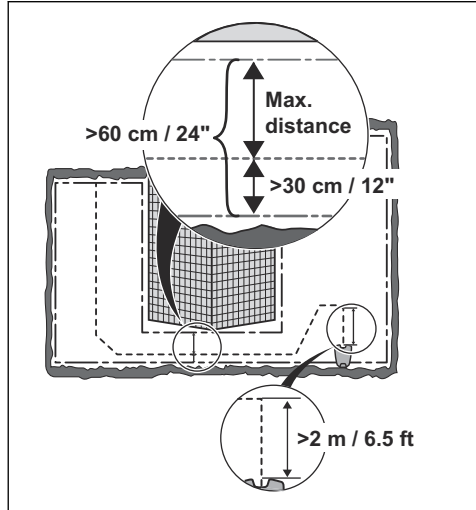

3.4.3.3 To make an island



CAUTION: Do not put a section of boundary wire across the other. The sections of boundary wire must be parallel.



CAUTION: Do not put the guide wire across the boundary wire, for example a boundary wire that goes to an island.

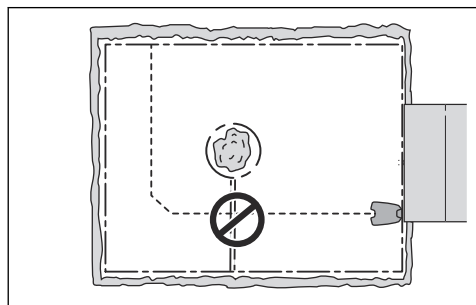

Some obstacles can withstand a collision, for example, trees or bushes taller than 15 cm / 6 in. The product will collide and then turn around with this type of obstacle. However, obstacles that slope slightly, for example stones or large trees

with raised roots, must be isolated or removed. The product can run onto this kind of obstacle causing the blades to be damaged. Use the boundary wire to isolate areas inside the work area by creating islands. When the boundary wires to and from the island are put close together, the product can run over the wire.

Note: To achieve careful and silent operation, it is recommended to isolate all fixed objects in the work area.

- Put the boundary wire to and around the obstacle to make an island.
- Put the 2 sections of boundary wire that run to and from the obstacle close together without crossing.
- Put the 2 sections of boundary wire in the same stake.

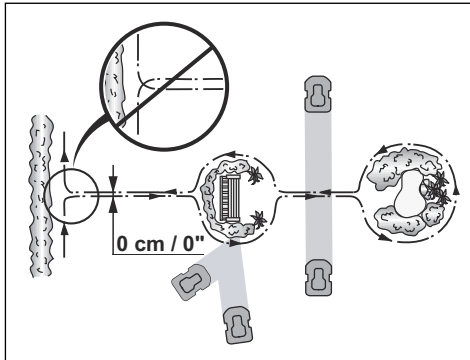

3.4.3.4 To make a secondary area

Make a secondary area (B) if the work area has 2 areas that are not connected with a passage. The work area with the charging station is the main area (A).

Note: The product must be manually moved between the main area and the secondary area.

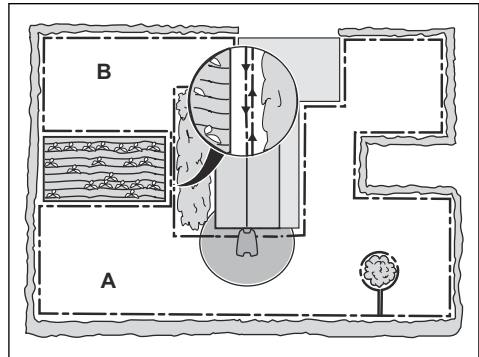

- Put the boundary wire around the secondary area (B) to make an island. Refer to *To make an island on page 18*.

Note: The boundary wire must be put as 1 loop around all of the work area (A + B).

Note: When the product cuts grass in the secondary area, the *Secondary area mode* must be selected. Refer to *Operating mode Start on page 36*.

3.4.4 To examine where to put the guide wire

- Put the guide wire in a line at a minimum of 2 m / 6.5 ft. in front of the charging station.
- Make as much free area as possible to the left of the guide wire when facing the charging station. Refer to *Corridor width on page 29*.
- Put the guide wire minimum 30 cm / 12 in. from the boundary wire.
- Do not make sharp bends when you install the guide wire.

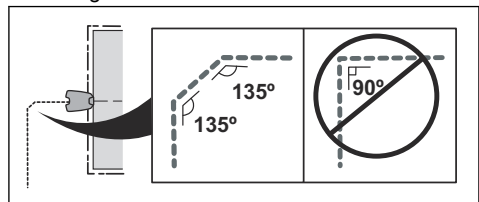

- If the work area has a slope, put the guide wire diagonally across the slope.

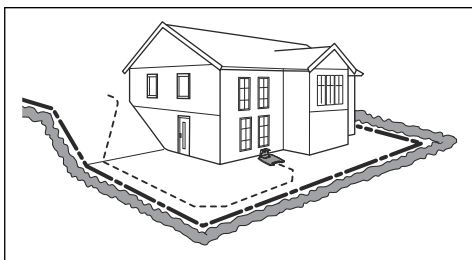

3.4.5 Work area examples

- If the charging station is put in a small area (A), make sure that the distance to the boundary wire is at a minimum 3 m / 10 ft. in front of the charging station.
- If the work area has a passage (B), make sure that the distance to the boundary wire is at a minimum 2 m / 6.5 ft. If the passage is smaller than 2 m / 6.5 ft., install a guide wire through the passage. Minimum passage between the boundary wire is 60 cm / 24 in.
- If the work area has areas which are connected by a narrow passage (B), you can set the product to first follow and then leave the guide wire after a certain distance (C). The settings can be changed in *Lawn Coverage* on page 27.
- Use the GPS Assisted Navigation that helps the product select the most optimal operation. Refer to *To set the GPS Assisted Navigation* on page 27.
- If the work area includes a secondary area (D), refer to *To make a secondary area* on page 19. Put the product in the secondary area and select *Secondary area mode*.

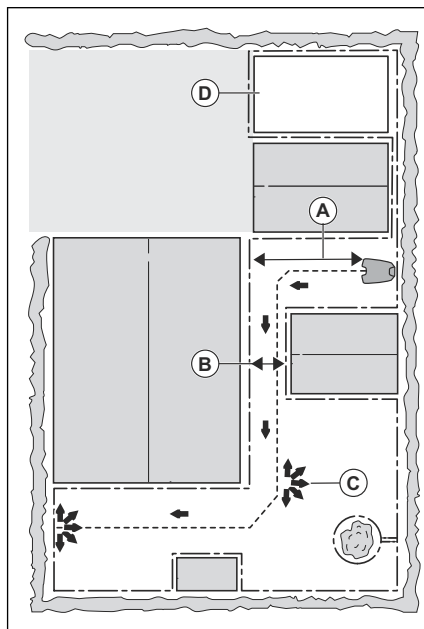

3.5 Installation of the product

3.5.1 Installation tools

- Hammer/plastic mallet: To simplify putting the stakes into the ground.
- Edge cutter/straight spade: To bury the boundary wire.
- Combination pliers: For cutting the boundary wire and pressing the connectors together.
- Adjustable plier: For pressing the couplers together.

3.5.2 To install the charging station



WARNING: Obey national regulations about electrical safety.



WARNING: The product is only to be used with the power supply unit supplied by Husqvarna.



WARNING: Do not put the power supply at a height where there is a risk it can be put in water. Do not put the power supply on the ground.



WARNING: Do not encapsulate the power supply. Condensed water can harm the power supply and increase the risk of electrical shock.



WARNING: Risk of Electric Shock. Install only to an residual-current device when connecting the power supply to the wall socket. Applicable to USA/Canada. If power supply is installed outdoors: Risk of Electric Shock. Install only to a covered Class A GFCI receptacle (residual-current device) that has an enclosure that is weatherproof with the attachment plug cap inserted or removed.



CAUTION: Do not make new holes in the charging station plate.



CAUTION: Do not put your feet on the baseplate of the charging station.



WARNING: The power supply cable and the extension cable must be outside the work area to avoid damage to the cables.

When connecting the power supply, only use a wall socket that is connected to an residual-current device.

1. Read and understand the instructions about the charging station. Refer to *To examine where to put the charging station on page 15*.
2. Put the charging station in the selected area.

Note: Do not attach the charging station to the ground with the screws until the guide

wire is installed. Refer to *To install the guide wire on page 22*.

3. Connect the low-voltage cable to the charging station.
4. Put the power supply at a minimum height of 30 cm / 12 in.

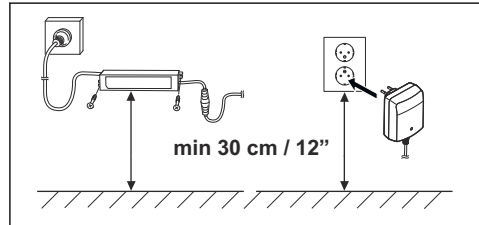

5. Connect the power supply cable to a 100-240V power outlet.

Note: When the charging station is connected, it is possible to charge the product. Place the product in the charging station while the boundary and guide wires are being laid. Switch on the product. Do not continue with any product settings before the installation is complete.

6. Put the low-voltage cable in the ground with stakes or bury the cable. Refer to *To put the wire into position with stakes on page 22* or *To bury the boundary wire or the guide wire on page 23*.
7. Connect the wires to the charging station after the installation of boundary wire and guide wire is complete. Refer to *To install the boundary wire on page 21* and *To install the guide wire on page 22*.
8. Attach the charging station to the ground with the supplied screws after the guide wire is installed. Refer to *To install the guide wire on page 22*.

3.5.3 To install the boundary wire



CAUTION: Do not put remaining wire in a coil. The coil causes interference with the product.

1. Put the boundary wire around all of the work area. Start and complete the installation behind the charging station.

- Open the connector and put the boundary wire in the connector.

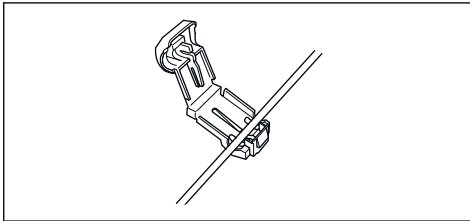

- Close the connector with a pair of pliers.

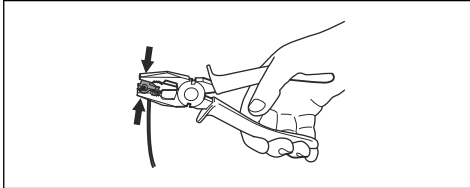

- Cut the boundary wire 1-2 cm / 0.4-0.8 in. above each connector.
- Push the right connector onto the metal pin on the charging station with the mark "AR".
- Push the left connector onto the metal pin on the charging station with the mark "AL".

3.5.4 To install the guide wire



CAUTION: Twinned cables, or a screw terminal block that is insulated with insulation tape are not satisfactory splices. Soil moisture will cause the wire to oxidize and after a time result in a broken circuit.

- Open the connector and put the wire in the connector.
- Close the connector with a pair of pliers.
- Cut the guide wire 1-2 cm / 0.4-0.8 in. above each connector.
- Push the guide wire through the slot in the charging station plate.
- Push the connector onto the metal pin on the charging station with the mark "GUIDE".
- Disconnect the charging station from the power outlet.
- Put the end of the guide wire at the eyelet on the boundary wire.
- Cut the boundary wire with a pair of wire cutters.

- Connect the guide wire to the boundary wire with a coupler.

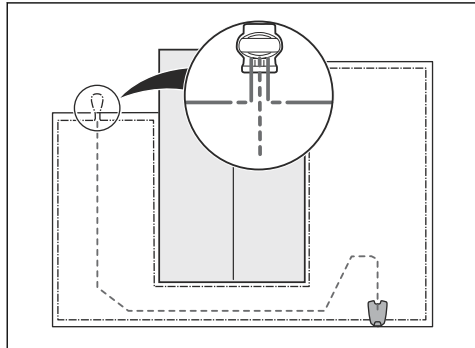

- Put the 2 ends of the boundary wire and the end of the guide wire into the coupler.

Note: Make sure that you can see the ends of the wires through the transparent area of the coupler.

- Push the button on the coupler with an adjustable pliers.

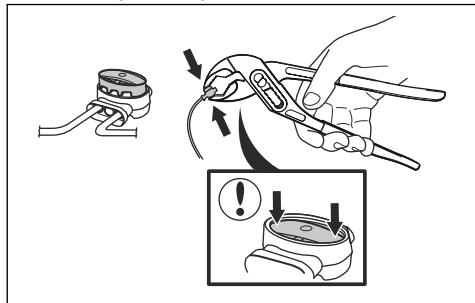

- Attach the guide wire to the ground with stakes or bury the guide wire in the ground. Refer to *To put the wire into position with stakes on page 22* or *To bury the boundary wire or the guide wire on page 23*.
- Connect the charging station to the power outlet.

3.6 To put the wire into position with stakes



CAUTION: Make sure that the stakes hold the boundary wire and the guide wire against the ground.



CAUTION: Cutting the grass too low right after installation can damage the wire insulation. Damage to the insulation may not cause disruptions until several weeks or months later.

1. Put the boundary wire and the guide wire on the ground.
2. Put the stakes at a maximum of 75 cm / 30 in. distance from each other.
3. Attach the stakes to the ground with a hammer or a plastic mallet.

Note: The wire is overgrown with grass and not visible after a few weeks.

3.7 To bury the boundary wire or the guide wire

- Cut a groove in the ground with an edge cutter or a straight shovel.
- Put the boundary wire or the guide wire 1-20 cm / 0.4-8 in. into the ground.

3.8 To extend the boundary wire or the guide wire

Note: Extend the boundary wire or the guide wire if it is too short for the work area. Use original spare parts, for example couplers.

1. Disconnect the charging station from the power outlet.
2. Cut the boundary wire or the guide wire with a pair of wire cutters where it is necessary to install the extension.
3. Add wire where it is necessary to install the extension.
4. Put the boundary wire or the guide wire into position.
5. Put the wire ends into a coupler.

Note: Make sure that you can see the ends of the boundary wire or the guide wire through the transparent area of the coupler.

6. Push the button on the coupler with an adjustable pliers.

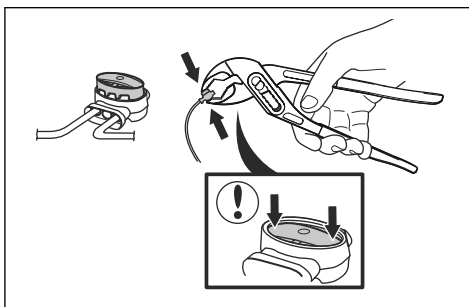

7. Put the boundary wire or the guide wire into position with stakes.
8. Connect the charging station to the power outlet.

3.9 After the installation of the product

3.9.1 To do a visual check of the charging station

1. Make sure that the indicator LED lamp on the charging station has a green light.

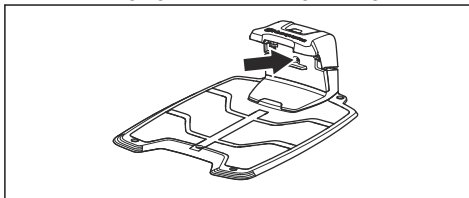

2. If the indicator LED lamp does not have a green light, do a check of the installation. Refer to *Indicator lamp in the charging station on page 49* and *To install the charging station on page 20*.

3.9.2 To do the basic settings

Before the product starts to operate for the first time, you must do the basic settings.

1. Put the product in the charging station.
2. Switch on the product.
3. Push the **arrow** buttons and the **OK** button. Select language, country, date, time and set a PIN code.

Note: It is not possible to use 0000 as PIN code.

4. Push the **Start** button and close the hatch to initiate a calibration process of the product.

Note: If the battery is too low, the product needs to charge the batteries fully before the calibration starts. Refer to *Calibration on page 24*.

3.9.3 Calibration

The calibration process is automatic. After the basic settings are done, the product moves away from the charging station and stops, while it calibrates some of the product settings. When the calibration is complete, the product starts to mow.

3.10 To do the product settings

All commands and settings for the product are done via the control panel. The control panel consists of a display and a keypad, and all functions are accessed through the menus. The functions have factory settings to suit most work areas, but the settings can be adapted to the unique situation for each work area.

3.10.1 Menu structure

The main menu contains:

- *Schedule*
- *Security*
- *Messages*
- *Weather timer (Automower® 315/315X)*
- *Installation*
- *Settings*
- *Accessories*

Refer to *Menu structure overview - 1 on page 7* and *Menu structure overview - 2 on page 8*.

3.10.2 To get access to the menu

1. Push the **STOP** button.
2. Use the **number** buttons and the **OK** button to enter the PIN code.
3. Push the **MENU** button.

3.10.3 Schedule



Note: The lawn should not be cut too often to obtain the best result. If the product is allowed to operate too much, the lawn may appear

flattened. The product is also subjected to unnecessary wear.

3.10.3.1 To set the schedule

1. Do steps 1–3 in *To get access to the menu on page 24*.
2. Use the **arrow** buttons and the **OK** button to move through the menu structure *Schedule > Overview*.
3. Use the **arrow** buttons and the **OK** button to select the day.
4. Use the right **arrow** button to select the period.
5. Push the **OK** button.
6. Calculate the suitable operating hours. Refer to *To calculate the suitable operating hours on page 24*.
7. Enter the time with the **number** buttons. The product can cut the grass 1 or 2 periods each day.

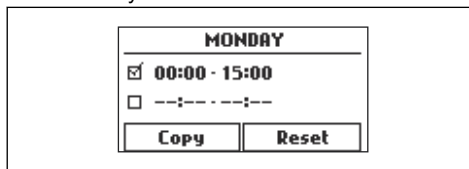

8. If the product must not cut grass on a specified day, unselect the box adjacent to the 2 time periods.

3.10.3.2 To calculate the suitable operating hours

If the work area is less than maximum product capacity, the schedule should be set to minimize wear on the lawn and the product.

1. Calculate the dimension of your lawn in m² / ft².
2. Divide the m² / ft² of the lawn with the approximate daily operation capacity. Refer to table below.
3. The result is equal to the number of hours that the product must mow each day. The number of hours includes both mowing, searching and charging time.

Note: The daily operation capacity is approximate and depends on the inbuilt standby period. Refer to *Schedule and Standby on page 37*.

Product work capacity	Approximate daily operation capacity, m ² /h, ft ² /h
Automower® 310	56 / 603
Automower® 315	68 / 732
Automower® 315X	73 / 786

Example: A lawn of 500 m² / 5400 ft², cut with a Automower® 310.

500 m² / 56 ≈ 9 h.

5400 ft² / 603 ≈ 9 h.

Days / week	h / day	Suggested schedule setting
7	9	07:00- 16:00 / 7:00 am - 4:00 pm

3.10.3.3 To copy the schedule setting

- Do steps 1–3 in *To get access to the menu on page 24*.
- Use the **arrow** buttons and the **OK** button to move through the menu structure *Schedule > Overview > Copy*.
- Use the **arrow** buttons and the **OK** button to copy the schedule setting. You can copy the schedule settings day to day or for the full week.

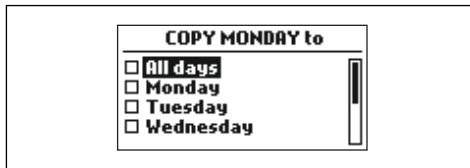

3.10.3.4 To reset the schedule setting

You can remove all schedule settings and use the factory setting.

- Do steps 1–3 in *To get access to the menu on page 24*.
- Use the **arrow** buttons and the **OK** button to move through the menu structure *Schedule > Overview > Reset*.
 - Push the **arrow** buttons to select *Current day* to only reset the current day to factory settings.

- Push the **arrow** buttons to select *All week* to reset all schedule settings to factory settings.

- Push the **OK** button.

3.10.3.5 Security level



There are 3 security levels for the product.

Function	Low	Medium	High
Alarm			X
PIN-code		X	X
Time lock	X	X	X

- Alarm** - An alarm goes off if the PIN-code is not entered within 10 seconds after the **STOP** button is pushed. The alarm also goes off when the product is lifted. The alarm stops when the PIN-code is entered.
- PIN-code** - The correct PIN-code must be entered to get access to the Menu structure of the product. If the incorrect PIN-code is entered 5 times, the product is locked for a time. The lock is extended for each new incorrect try.
- Time lock** - The product locks if the PIN-code has not been entered in 30 days. Enter the PIN-code to get access to the product.

To set the security level

Select 1 of 3 security levels for your product.

- Do steps 1–3 in *To get access to the menu on page 24*.
- Use the **arrow buttons** and the **OK** button to move through the menu structure *Settings > Security > Security level*.
- Use the **arrow buttons** and the **OK** button to select the level of security.
- Push the **OK** button.

To create a New loop signal

The loop signal is randomly selected to create a unique link between the product and the charging station. In rare cases, there may be a need to generate a new signal, for instance if two adjacent installations have a very similar signal.

- Place the product in the charging station.

- Do steps 1–3 in *To get access to the menu on page 24*.
- Use the **arrow** buttons and the **OK** button to move through the menu structure *Security > Advanced > New loop signal*.
- Await confirmation that the loop signal has been generated. This normally takes about 10 seconds.

To change the PIN-code

- Do steps 1–3 in *To get access to the menu on page 24*.
- Use the **arrow** buttons and the **OK** button to move through the menu structure *Settings > Security > Advanced > Change PIN-code*.
- Enter the new PIN code.
- Push the **OK** button.
- Enter the new PIN code.
- Push the **OK** button.
- Make a note of the new PIN code. Refer to *Introduction on page 3*.

To change the length of the alarm

- Do steps 1–3 in *To get access to the menu on page 24*.
- Use the **arrow buttons** and the **OK** button to move through the menu structure *Security > Advanced > Duration > Duration of alarm*.
- Use the **arrow buttons** to select a time interval of 1 to 20 minutes.
- Push the **BACK** button.

To change the length of the time lock

- Do steps 1–3 in *To get access to the menu on page 24*.
- Use the **arrow buttons** and the **OK** button to move through the menu structure *Security > Advanced > Duration > Duration of time lock*.
- Use the **number buttons** to select a time interval of 1–90 days.
- Push the **BACK** button.

3.10.3.6 Messages



In this menu the previous fault and information messages can be found. For some of the messages, there are tips and advice to help to

rectify the fault. Refer to *Troubleshooting on page 43*.

If the product is disrupted in any way, for example it is trapped or the battery is low, a message is saved relating to the disruption and the time it happened.

If the same message is repeated several times, this may indicate that an adjustment to the installation or the product is required. Refer to *Installation on page 15*.

To read the messages

- Do steps 1–3 in *To get access to the menu on page 24*.
- Use the **arrow** buttons and the **OK** button to move through the menu structure *Messages > Fault messages and Messages > Info messages*.
- Read the messages and read the *Troubleshooting* to get information and recommendations to correct the faults.

3.10.4 Weather timer



Weather timer automatically adjust the cutting time to the growth of the grass. The product is not permitted to operate more than the schedule settings.

Note: When using *Weather timer*, it is recommended to make as much operating time as possible available for *Weather timer*. Do not restrict the schedule more than necessary.

The first operation of the day is set by the schedule settings. The product always complete 1 mowing cycle, and then *Weather timer* selects if the product will continue to operate or not.

Note: *Weather timer* is reset if the product does not operate for more than 50 hours, or if a *Reset of all user settings* is done. *Weather timer* is not changed if a *Reset of schedule settings* is done.

3.10.4.1 To set the Weather timer

- Do steps 1–3 in *To get access to the menu on page 24*.

- Use the **arrow** buttons and the **OK** button to move through the menu structure *Weather timer > Use Weather timer*.
- Push the **OK** button to select the *Weather timer*.
- Push the **BACK** button.

3.10.4.2 To set the Weather timer frequency

Set how frequently the product cuts the grass when the *Weather timer* is in use. There are 3 frequency levels: *Low*, *Mid* and *High*. The higher the frequency, the more sensitive the product is to the grass growth. That is, if the grass growth is high then the product is allowed to work longer.

Note: If the mowing results are not optimal when using *Weather timer*, the schedule settings may need adjusting. Do not restrict the schedule more than necessary. Also, check that the blade disc is clean and that the blades are in good condition.

- Do steps 1–3 in *To get access to the menu on page 24*.
- Use the **arrow** buttons and the **OK** button to move through the menu structure *Weather timer > Cutting time*.
- Use the **arrow** buttons to select *Low*, *Mid* or *High* frequency.
- Push the **BACK** button.

3.10.5 Lawn Coverage

If the work area includes remote parts that are connected with narrow passages, the *Lawn Coverage* function is useful to be able to maintain a well-cut lawn in all parts of the yard. A guide wire must be installed to use the functions. You can set a maximum of 3 remote areas.

With the *Lawn Coverage* function the product first follows and then leaves the guide wire after a certain distance and starts to mow the lawn.

Area A, approximately 50%

Area B, approximately 30%

Area C, approximately 20%

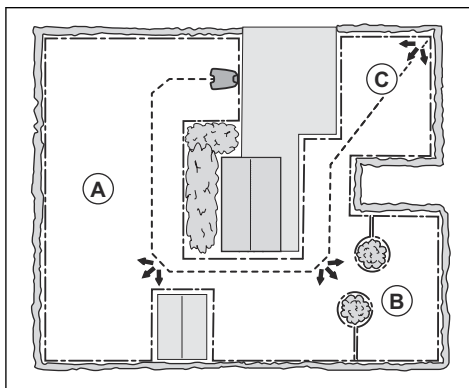

3.10.5.1 GPS Assisted Navigation

Only for Automower® 315X.

The GPS Assisted Navigation function helps the product to select the most optimal operation. Use the *Lawn coverage* function to do manual settings.

To set the GPS Assisted Navigation

Disable the GPS Assisted Navigation to make manual settings in *Lawn coverage*.

Note: It is recommended to use GPS Assisted Navigation.

- Do steps 1–3 in *To get access to the menu on page 24*.
- Use the **arrow** buttons and the **OK** button to move through the menu structure *Installation > Lawn coverage*.
- Push the **OK** button to enable or disable the function.
- Push the **BACK** button.

3.10.5.2 To set the Lawn Coverage function

- Do steps 1–3 in *To get access to the menu on page 24*.
- Use the **arrow** buttons and the **OK** button to move through the menu structure *Installation > Lawn Coverage > Area 1-3*.
- Use the **arrow** button to select the area.
- Push the **OK** button.
- Measure the distance from the charging station to the start of the area. Measure along the guide wire. Refer to *To measure*

the distance from the charging station on page 28.

6. Push the **number** buttons to select the distance.
7. Push the **OK** button.
8. Use the **number** buttons to select the percentage of the cutting time the product must cut the area. The percentage is equal to the area in relation to the complete work area.
 - a) Measure the area.
 - b) Divide the measured area with the total work area.
 - c) Convert the result to percentage.

Note: The sum of Area 1-3 must be 100% or less. If the sum is less than 100%, the product sometimes starts to mow at the charging station. Refer to *To set the exit angle on page 30.*

9. Push the **BACK** button.

3.10.5.3 To do a test of the Lawn Coverage function

1. Put the product in the charging station.
2. Do step 1-3 in *To get access to the menu on page 24.*
3. Use the **arrow** buttons and the **OK** button to move through the menu structure *Installation > Lawn Coverage > Area 1-3 > More > Test.*
4. Push the **OK** button.
5. Push the **START** button.
6. Close the hatch.
7. Make sure the product can find the area.

3.10.5.4 To measure the distance from the charging station

1. Put the product in the charging station.
2. Do steps 1-3 in *To get access to the menu on page 24.*
3. Use the **arrow** buttons and the **OK** button to move through the menu structure *Installation > Lawn Coverage > Area 1-3 > How far?*
4. Use the **number** buttons to set 500 m / 500 yd as a distance.
5. Push the **OK** button.

6. Use the **arrow** buttons and the **OK** button to move through the menu structure *Settings > Lawn Coverage > Area 1-3 > More > Test.*
7. Push the **OK** button.
8. Push the **STOP** button when the product is at the distance you select to measure. The distance shows in the display.

3.10.5.5 To disable or enable the Lawn Coverage function

Disable or enable the *Lawn Coverage* function for each area.

1. Do steps 1-3 in *To get access to the menu on page 24.*
2. Use the **arrow** buttons and the **OK** button to move through the menu structure *Installation > Lawn Coverage > Area 1-3 > Disable.*
3. Push the **OK** button.
4. Push the **BACK** button.

3.10.5.6 To reset the Lawn Coverage settings

You can reset the *Lawn Coverage* settings for each area and use the factory setting.

1. Do steps 1-3 in *To get access to the menu on page 24.*
2. Use the **arrow** buttons and the **OK** button to move through the menu structure *Installation > Lawn Coverage > Area 1-3 > More > Reset.*
3. Push the **OK** button.

3.10.6 Methods for the product to find the charging station

The product has 3 search methods to find the charging station :

- Irregular - The product moves in the work area until it finds the signal of the charging station.
- Guide wire - The product moves in the work area until it finds the guide wire. The product moves along the guide wire to the charging station.
- Boundary wire - The product moves in the work area until it finds the boundary wire. The product moves along the boundary wire to the charging station.

The factory setting is set to mix the 3 search methods. When the battery is low the product starts to search for the charging station with the

irregular method for 3 min. After 3 min the product changes search method to the guide wire method. The product tries to find the guide wire for 8 min. After 11 min the product changes search method to the boundary wire method.

You can change the settings for how the product finds the charging station to adapt to the work area.

3.10.6.1 To set how the product finds the charging station

You can make manual settings to make the product search for the guide wire or the boundary wire in 0–30 min from when the battery is low.

1. Do steps 1–3 in *To get access to the menu on page 24*.
2. Use the **arrow buttons** and the **OK** button to move through the menu structure *Installation > To find the charging station > Overview of search methods > Guide*.
3. Push the **arrow buttons** to select 1 of the guide wires.
4. Push the **number buttons** to set the time.
5. Push the **OK** button.
6. Push the **BACK** button.
7. Use the **arrow buttons** and the **OK** button to move through the menu structure *Installation > To find the charging station > Overview of search methods > Boundary wire*.
8. Push the **number buttons** to set the time.
9. Push the **OK** button.
10. Push the **START** button and close the hatch.

3.10.6.2 To do a test of the guide wire

1. Do steps 1–3 in *To get access to the menu on page 24*.
2. Use the **arrow buttons** and the **OK** button to move through the menu structure *Installation > Find charging station > Guide > More > Test guide*.
3. Put the product 3 m / 9 ft. from the boundary wire.
4. Push the **START** button and close the hatch.
5. Make sure the product follows the guide wire to the charging station.
6. Make sure the product docks with the charging station.

7. If the product does not dock with the charging station, change the position of the charging station or the guide wire. Refer to *To install the charging station on page 20* and *To install the guide wire on page 22*.

3.10.6.3 To do a test of the boundary wire

1. Put the product 3 m / 9 ft. from the boundary wire, facing the boundary wire.
2. Do steps 1–3 in *To get access to the menu on page 24*.
3. Use the **arrow buttons** and the **OK** button to move through the menu structure *Installation > Find charging station > Overview of search methods > Boundary > More > Test right / Test left*.
4. Push the **START** button and close the hatch.
5. Make sure the product follows the guide wire to the charging station.
6. Make sure the product docks with the charging station.
7. Change the position of the charging station or the guide wire if the product does not dock with the charging station. Refer to *To install the charging station on page 20* and *To install the guide wire on page 22*.

3.10.6.4 To change the signal range of the charging station

1. Do steps 1–3 in *To get access to the menu on page 24*.
2. Use the **arrow buttons** and the **OK** button to move through the menu structure *Installation > Find the charging station > Overview of search methods > Charging station range*.
3. Use the left **arrow button** to select *MAX, MID, MIN*.
4. Push the **BACK** button.

Note: It is usually better to move the charging station, than to decrease the range of the charging station signal.

3.10.7 Corridor width

The boundary wire corridor is the area adjacent to the boundary wire and the guide corridor is the area adjacent to the guide wire. The product uses the corridors to find the charging station. When the product moves in the direction of the charging

station, it always moves to the left of the guide wire.

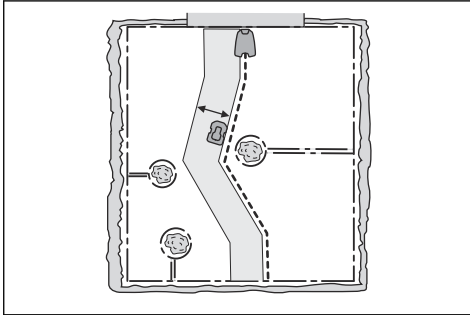

The corridor width is adjusted automatically. Only in rare occasions manual settings need to be entered. The corridor width can be set between 0-9. If guide corridor width is set to 0, the product runs over the guide wire. The factory setting is 6 for the boundary wire and 9 for the guide wire.

3.10.7.1 To set the corridor width

1. Do steps 1–3 in *To get access to the menu on page 24*.
2. Use the **arrow** buttons and the **OK** button to move through the menu structure *Installation > Advanced > Corridor width*.
3. Use the **arrow** buttons to select a corridor.
4. Use the **number** buttons to select a corridor width of 0-9.

Note: Make the corridor width as wide as possible for a minimum risk of lines in the lawn.

3.10.8 Exit angle

If the sum of the *Lawn Coverage* function is less than 100%, the product sometimes starts to mow at the charging station. The product moves away from the charging station with an exit angle between 90°–270°. The exit angles can be set to 1–2 exit sectors.

3.10.8.1 To set the exit angle

1. Do steps 1–3 in *To get access to the menu on page 24*.
2. Use the **arrow** buttons and the **OK** button to move through the menu structure *Installation > Advanced > Exit angles > Sector 1*.
3. Use the **number** buttons to set the angles in degrees.

4. Push the down **arrow** button.
5. Use the **number** buttons to select how frequently the product must use each sector. Set in percentage.
6. Push the **BACK** button.

3.10.9 Reversing distance

The reversing distance makes the product move in reverse for a set distance, before the product starts to cut the lawn. The factory setting is 60 cm / 2 ft.

3.10.9.1 To set the reversing distance

1. Do steps 1-3 in *To get access to the menu on page 24*.
2. Use the **arrow** button and the **OK** button to move through the menu structure *Installation > Advanced > Reversing distance*.
3. Use the **number** buttons to set the distance.
4. Push the **BACK** button.

3.10.10 Drive Past Wire function

The front of the product always moves past the boundary wire by a specified distance before the product moves back into the work area. The factory setting is 31 cm / 13 in. You can select a distance of 20-50 cm / 10-15 in.

Note: If the *Drive Past Wire* distance is changed, the distance will change along the boundary wire everywhere in the work area.

3.10.10.1 To set the Drive Past Wire function

1. Do steps 1–3 in *To get access to the menu on page 24*.
2. Use the **arrow** button and the **OK** button to move through the menu structure *Installation > Advanced > Drive Past Wire*.
3. Use the **number** buttons to set the distance.
4. Push the **BACK** button.

3.10.11 Settings



In settings you can change the general settings to your product.

3.10.11.1 Profiles

With the function Profiles, different sets of product settings can be saved. This can be used when one product is used for more than one work areas and charging stations. The product settings and the pairing with the charging stations are saved in the profile and can easily be used again.

To save settings to a profile

1. Do steps 1–3 in *To get access to the menu on page 24*.
2. Use the **arrow buttons** and the **OK** button to move through the menu structure *Settings > Profiles > Use profiles > Profile A, B, C*.
3. Use the **arrow buttons** and the **OK** button to select and save the profile.
4. Push the **BACK** button.

If settings have been changed but not saved, the symbol * is shown beside the profile name.

To change the name of a profile

1. Do steps 1–3 in *To get access to the menu on page 24*.
2. Use the **arrow buttons** and the **OK** button to move through the menu structure *Settings > Profiles > Use profiles > Profile A, B, C > Rename*.
3. Use the **arrow buttons** and the **OK** button to select letters.
4. Push the **BACK** button to save the new profile name.

To use a profile

1. Do steps 1–3 in *To get access to the menu on page 24*.
2. Use the **arrow buttons** and the **OK** button to move through the menu structure *Settings > Profiles > Use profiles > Profile A, B, C > Select*.
3. Push the **BACK** button.

To connect a new charging station to a profile

1. Save the settings in a profile to be used with the original charging station. Do steps 1–4 in *To save settings to a profile on page 31*.
2. Put the product in the new charging station.
3. Use the **arrow buttons** and the **OK** button to move through the menu structure *Security > Advanced > New loop signal*.

4. Save a profile for the new charging station, or select a profile in the list. Do steps 1–4 in *To save settings to a profile on page 31*, or do steps 1–3 in *To use a profile on page 31*.

3.10.12 ECO mode

If *ECO mode* is activated, it switches off the signal in the boundary loop, the guide wire and the charging station, when the product is parked or is charging.

Note: Use *ECO mode* to save energy and avoid interference with other equipment, for example hearing loops or garage doors.

Note: To start the product manually in the work area, push the **STOP** button before you remove the product from the charging station. If not, the product can not be started in the work area.

3.10.12.1 To set the ECO mode

1. Do steps 1–3 in *To get access to the menu on page 24*.
2. Use the **arrow buttons** and the **OK** button to move through the menu structure *Settings > ECO mode*.
3. Push the **OK** button to select the *ECO mode*.
4. Push the **BACK** button.

3.10.12.2 Spiral Cutting

The product cuts the grass in a spiral pattern if the grass is longer in an area. *Spiral cutting* can be set in 5 levels:

- Low-
- Low
- Mid
- High
- High+

The level sets how sensitive the product is to changes in grass height.

Note: *Spiral cutting* is only started in the Main area mode. Cutting in the *Secondary area* mode does not let the product to start *Spiral cutting*. *Spiral Cutting* does not start in slopes steeper than 15%.

To set the Spiral Cutting

1. Do steps 1–3 in *To get access to the menu on page 24*.
2. Use the **arrow buttons** and the **OK** button to move through the menu structure *Settings > Spiral Cutting > Use Spiral Cutting*.
3. Push the **BACK** button.

To set the level of Spiral Cutting

1. Do steps 1–3 in *To get access to the menu on page 24*.
2. Use the **arrow buttons** and the **OK** button to move through the menu structure *Settings > Spiral Cutting > Use Spiral Cutting > Intensity*.
3. Use the left **arrow button** to select the level of the Spiral Cutting.
4. Push the **BACK** button.

3.10.12.3 Slope control

In order to decrease lawn wear near the boundary wire in slopes, the product prevents to move in the opposite direction when the product operates in a slope. *Slope control* is enabled in the factory settings.

To set the Slope control

1. Do steps 1–3 in *To get access to the menu on page 24*.
2. Use the **arrow buttons** and the **OK** button to move through the menu structure *Settings > Slope control > Use Slope control*.
3. Push the **BACK** button.

3.10.13 General

In *General* you can change the general settings of the product.

3.10.13.1 To set the time & date

1. Do steps 1–3 in *To get access to the menu on page 24*.
2. Use the **arrow buttons** and the **OK** button to move through the menu structure *Settings > General > Time & Date*.
3. Use the **number buttons** to set the time and then push the **BACK** button.
4. Use the **number buttons** to set the date and then push the **BACK** button.
5. Use the **arrow buttons** to set the time format and then push the **BACK** button.

6. Use the **arrow buttons** to set the date format and then push the **BACK** button.

3.10.13.2 To set the language

1. Do steps 1–3 in *To get access to the menu on page 24*.
2. Use the **arrow buttons** and the **OK** button to move through the menu structure *Settings > General > Language*.
3. Use the **arrow buttons** to select language and then push the **BACK** button.

3.10.13.3 To set the Country & Timezone

1. Do steps 1–3 in *To get access to the menu on page 24*.
2. Use the **arrow buttons** and the **OK** button to move through the menu structure *Settings > General > Country & Timezone*.
3. Use the **arrow buttons** to select country and then push the **BACK** button.

3.10.13.4 To set the unit format

1. Do steps 1–3 in *To get access to the menu on page 24*.
2. Use the **arrow buttons** and the **OK** button to move through the menu structure *Settings > General > Unit format*.
3. Use the **arrow buttons** to select unit format and then push the **BACK** button.

3.10.13.5 To reset all user settings

1. Do steps 1–3 in *To get access to the menu on page 24*.
2. Use the **arrow buttons** and the **OK** button to move through the menu structure *Settings > General > Reset all user settings*.
3. Use the right **arrow button** to select *Proceed with reset of all user settings?*
4. Push the **OK** button to reset all the user settings.

Note: *Security level, PIN code, Loop signal, Messages, Date & Time, Language and Country settings* are not reset.

3.10.13.6 The About menu

The *About* menu displays information about the product, for example serial number and firmware versions.

3.10.14 Accessories



Settings for accessories mounted on the product can be made in this menu.

3.10.14.1 Information

This menu handles accessories mounted on the product. Contact your local Husqvarna representative for more information on available accessories.

3.10.14.2 Automower® Connect app

The app gives two modes of connectivity: Long-range cellular connectivity and Short-range Bluetooth® connectivity. Automower® 310/315/315X support only Bluetooth® communication. If they get Automower® Connect installed as an accessory, they also support cellular communication.

The product can connect to mobile devices that have the Automower® Connect app installed. Automower® Connect is a free app for your mobile device. The Automower® Connect app gives extended functions to your Husqvarna product. You can:

- See the status of your product.
- Change settings to your product.
- Get extended product information.
- Get an alarm if the product moves out of the work area.
- See statistics of your product.

Note: All countries do not support Automower® Connect because of legal reasons and regional specified cellular systems. The included Automower® Connect lifetime service only applies if there is a third part sub-supplier of 2G/3G/4G available in the operational area. In some countries Bluetooth® is not available due to legal reasons.

To install the Automower® Connect app

1. Download the Automower® Connect app on your mobile device.
2. Sign up for a Husqvarna account in the Automower® Connect app.
3. Log in to your Husqvarna account in the Automower® Connect app.

3.10.14.3 Automower® Connect@Home

Connect@Home uses a short-range Bluetooth® wireless technology. This means that you can communicate between the mobile device and the product while you are in communication range. An icon for Bluetooth® communication will show in the product display when the product is connected with your mobile device.

Note: Connect@Home has equivalent but not as extended functions as Automower® Connect, and uses the same app.

To pair Connect@Home and the product

1. Do steps 1–3 in *To get access to the menu on page 24*.
2. Use the **arrow buttons** and the **OK** button to move through the menu structure *Accessories > Connect@Home > Pairing > New pairing*.
3. Follow the instructions in the app.

Note: Automower® Connect is always connected to your product as long as the mobile device have connection with the mobile network, the product is charged and main switch is set in position 1.

To remove paired accounts

1. Do steps 1–3 in *To get access to the menu on page 24*.
2. Use the **arrow** buttons and the **OK** button to move through the menu structure *Accessories > Connect@Home > Pairing > Remove paired accounts*.
3. Push the **OK** button to select *YES/NO* to remove all paired accounts.

3.10.14.4 Automower® Connect

Automower® Connect is included in Automower® 315X and is available as an accessory for Automower® 310/315.

To pair Automower® Connect and the product

1. Do steps 1–3 in *To get access to the menu on page 24*.
2. Use the **arrow** buttons and the **OK** button to move through the menu structure *Accessories > Automower® Connect > Pairing > New pairing*.

3. Follow the instructions in the app.

To enable the GeoFence function

GeoFence is a GPS-based theft protection that makes a virtual fence for the product. You will get a message if the product is moved on the other side of the GeoFence.

1. Put the product in the center of the work area.
2. Do steps 1–3 in *To get access to the menu on page 24*.
3. Use the **arrow buttons** and the **OK** button to move through the menu structure *Accessories > Automower Connect > GeoFence > Activate GeoFence*.
4. Push the **OK** button.
5. Select *Activate GeoFence* and push the **OK** button.

To set a new center point for the Geofence function

1. Put the product in the center of the work area.
2. Do steps 1–3 in *To get access to the menu on page 24*.
3. Use the **arrow buttons** and the **OK** button to move through the menu structure *Accessories > Automower Connect > GeoFence > New center point*.
4. Push the **OK** button.

To set the GeoFence level of sensitivity

The higher level of GeoFence sensitivity, the easier the alarm starts.

1. Do steps 1–3 in *To get access to the menu on page 24*.
2. Use the **arrow buttons** and the **OK** button to move through the menu structure *Accessories > Automower Connect > GeoFence*.
3. Use the **arrow buttons** to select level of GeoFence sensitivity.
4. Push the **BACK** button.

To use the SMS function

The SMS function sends you an SMS when the product is moved out of the GeoFence.

1. Do steps 1–3 in *To get access to the menu on page 24*.

2. Use the **arrow** buttons and the **OK** button to move through the menu structure *Accessories > Automower Connect > Communication > Use SMS*.
3. Push the **OK** button.
4. Use the **arrow** buttons and the **OK** button to move through the menu structure *Accessories > Automower Connect > Communication > SMS phone numbers*.
5. Push the **number** buttons to enter the telephone number with country code. For example (+)46701234567.
6. Push the **BACK** button.

Note: There is a maximum of 10 SMS each month from the product.

Network

APN settings

The product must specify APN settings to be able to use and send data via the mobile net. Settings for Husqvarna SIM is default.

3.10.14.5 Headlights Automower® 315X

To set the schedule for the headlights

1. Do steps 1–3 in *To get access to the menu on page 24*.
2. Use the **arrow** buttons and the **OK** button to move through the menu structure *Accessories > Headlights > Schedule*.
3. Select between *Always ON, Evening only, Evening & night* or *Always OFF*.

Note: *Evening only* will start the schedule for the headlights at sunset and stop at midnight. *Evening & night* will start the schedule for the headlights at sunset and stop at sunrise.

To set the Flashes when fault function

The headlights flashes if the product stops to operate because of a fault if *Flashes when fault* is enabled.

1. Do steps 1–3 in *To get access to the menu on page 24*.
2. Use the **arrow** buttons and the **OK** button to move through the menu structure *Accessories > Headlights > Flashes when fault*.

3. Use the **OK** button to enable or disable the *Flashes when fault* function.

3.10.14.6 To avoid collisions with the mower house

The wear on the product and the mower house decreases when you select *Avoid collisions with mower*.

1. Do steps 1–3 in *To get access to the menu on page 24*.
2. Use the arrow buttons and the **OK** button to move through the menu structure *Accessories > Mower house > Avoid collisions with mower*.

Note: If *Avoid collisions with mower* is selected it can result in grass that is not cut around the charging station.

4 Operation

4.1 Main switch



WARNING: Read the safety instructions carefully before you start the product.



WARNING: Keep your hands and feet away from the rotating blades. Never put your hands or feet close to or under the product when the motor is running.



WARNING: Do not use the product when persons, especially children, or animals, are in the work area.

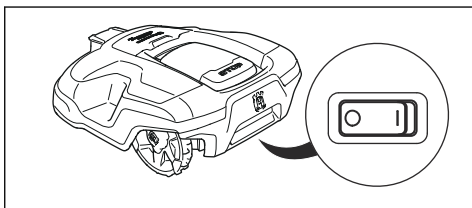

- Set the **Main switch** in the *1* position to start the product.
- Set the **Main switch** in the *0* position when the product is not in use or before any work, inspection or maintenance is carried out.

4.2 To start the product

1. Push the **STOP** button to open the hatch.
2. Set the **Main switch** to position *1*.
3. Enter the PIN code.
4. Push the **START** button.
5. Select the desired operating mode and confirm with the **OK** button. Refer to *Operating mode Start on page 36*.

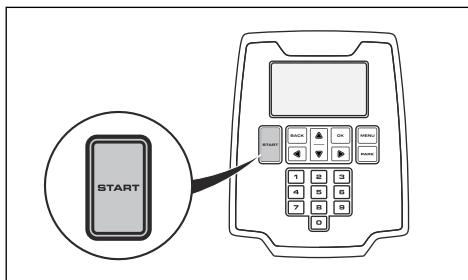

6. Close the hatch.

Note: If the product is parked in the charging station, the product only leaves the charging station when the battery is fully charged and if the schedule allows the product to operate.

Note: The first weeks after installation the perceived sound level when cutting the grass may be higher than expected. When the product has cut the grass for some time, the perceived sound level is much lower.

4.3 Operating mode Start

Push the **START** button to select the following operating modes:

- *Main area*
- *Secondary area*
- *Override schedule*
- *Spot cutting*

4.3.1 Main area

Main area is the standard operating mode where the product mows and charges automatically.

4.3.2 Secondary area

To mow secondary areas the operating mode *Secondary area* must be selected. In this mode, the operator must move the product manually between the main area and the secondary area. The product mows for a selected period of time or until the battery is empty. When the battery is empty, the product stops and the message *Needs manual charging* shows in the product display. Put the product in the charging station to charge the battery. When the battery is charged,

the product moves out of the charging station and stops. The product is now prepared to start operation, but needs confirmation from the operator first. In the *Secondary area* mode, the product operates for a selected period of time or until the battery is empty.

Note: If you want to cut the main area after the battery is charged, set the product to *Main area* mode before you put the product in the charging station.

4.3.3 Override schedule

The schedule settings can be temporarily overridden by selecting *Override schedule*. It is possible to override the schedule for 24 h or 3 days. It is not possible to override a standby period.

4.3.4 Spot cutting

The *Spot cutting* function is activated with the **START** button and is useful for quickly mowing an area where the grass has been mown less than in other parts of the yard. You must manually move the product to the chosen area.

Spot cutting means that the product mows in a spiral pattern in order to cut the grass in the area where it was started. When this is done, the product automatically switches back to *Main area* or *Secondary area*.

4.4 Operating mode Park

Push the **PARK** button to select the following operating modes:

- *Park until further notice*
- *Start with schedule*

4.4.1 Park until further notice

The operation mode Park means that the product goes back to the charging station where it stays until a new operation mode is selected and the **START** button is pushed.

4.4.2 Start again with next schedule

The product stays in the charging station until the next *Schedule* setting permits operation. This operating mode is suitable if you want to cancel an ongoing mowing cycle and allow the product to stay in the charging station until the next day.

4.5 To stop the product

1. Push the **STOP** button on top of the product.

The product stops and the blade motor stops.

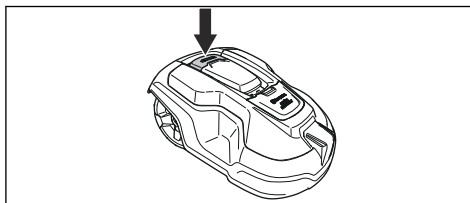

4.6 To switch off the product

1. Push the **STOP** button on top of the product.
2. Set the **Main switch** to position 0.

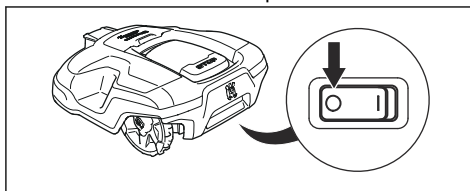

4.7 Schedule and Standby

The product has an inbuilt standby period according to the Standby time table. The standby period provides for instance a good opportunity to water or play games on the lawn.

The standby time is depending on how much active time (cutting and searching) the product has each day. The active time is in turn depending on for example battery capacity, slopes and grass growth. When the product has operated the allowed active period in a day, the message *Today's mowing complete* is shown in the display. The product is then in standby mode until next day.

If the schedule setting is divided into 2 work periods, the standby period can be divided into a number of periods. The minimum standby period time must however be according to the Standby time table.

Product work capacity	Standby time, minimum hours per day
Automower® 310	6
Automower® 315	2
Automower® 315X	2

4.7.1 Example 1

This example is applicable to products with a specified work area of 1000 m², but the principle is the same for the other models.

Schedule setting, Period 1: 00:00-24:00

Active period (A): 00:00-18:00

The schedule settings ensure that the product begins cutting the lawn at 00:00. At 18:00 the product has reached the maximum available operating hours and is therefore parked in standby mode. The product starts cutting the grass again next day at 00:00.

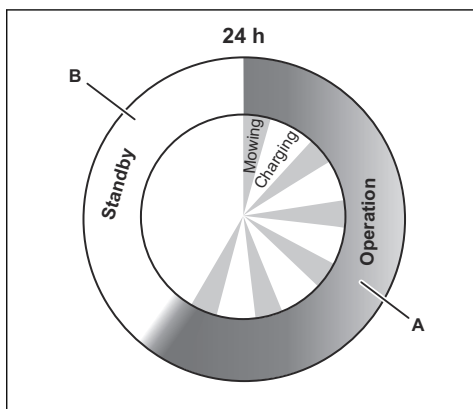

Example: A specified work area of 1000 m ²	
Operation, A = max. hours	18
Charging/Standby, B = min. hours	6

4.7.2 Example 2

This example is applicable to products with a specified work area of 1000 m², but the principle is the same for the other models.

The timer settings can be divided into 2 work periods to prevent mowing when there usually is other activities ongoing. If the timer setting is divided into 2 work periods, the minimum standby

period must in total be according to the Standby time table. Refer to *Schedule and Standby on page 37*.

Timer setting Period 1 (A): 00:00-12:00

Timer setting Period 2 (C): 18:00-24:00

Active period (A): 00:00-12:00

Active period (C): 18:00-22:00

The product operates between 00:00 and 12:00. It starts again at 18:00 but stops at 22:00 due to standby mode until it starts again at 00:00.

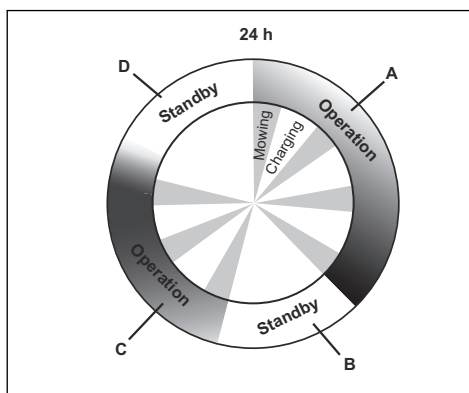

Example: A specified work area of 1000 m ²	
Operation, A + C = max. hours	18
Charging/Standby, B + D = min. hours	6

4.8 To charge the battery



WARNING: Only charge the product using a charging station which is intended for it. Incorrect use may result in electric shock, overheating or leakage of corrosive liquid from the battery.

In the event of leakage of electrolyte flush with water and seek medical help if it comes in contact with the eyes etc.

When the product is new or has been stored for a long period, the battery can be empty and needs to be charged before starting. In the *Main area* mode, the product automatically alternates between mowing and charging.

1. Set the **Main switch** to position *1*.
2. Place the product in the charging station. Slide the product in as far as possible to ensure proper contact between the product and the charging station. Refer to contact and charging plates in *Product overview Automower® 310/315/315X on page 4*
3. The display shows a message that charging is in progress.

4.9 Adjust the cutting height



CAUTION: During the first weeks after a new installation, the cutting height must be set to MAX to avoid damaging the loop wire. After this, the cutting height can be lowered step by step every week until the desired cutting height has been reached.

The cutting height can be varied from MIN (2 cm / 0.8 in.) to MAX (6 cm / 2.4 in.).

4.9.1 To adjust the cutting height

1. Push the **STOP** button to stop the product.
2. Open the hatch.

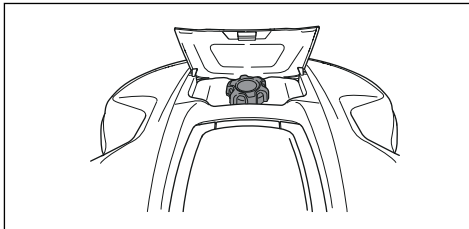

3. Turn the knob to the required position.
 - Turn clockwise to increase the cutting height.
 - Turn counter-clockwise to decrease the cutting height.
4. Close the hatch.

5 Maintenance

5.1 Introduction - maintenance



WARNING: The product must be switched off before any maintenance is done.



WARNING: Wear protective gloves.

For better operation and longer service life, make sure to clean the product regularly and replace worn parts. All maintenance and servicing must be done according to Husqvarna's instructions. Refer to *Warranty on page 58*.

When the product is first used, the blade disc and blades should be inspected once a week. If the amount of wear during this period has been low, the inspection interval can be increased.

It is important that the blade disc rotates easily. The edges of the blades should not be damaged. The lifetime of the blades varies immensely and depends for instance on:

- Operating time and size of the work area.
- Type of grass and seasonal growth.
- Soil, sand and use of fertilizers.
- The presence of objects such as cones, windfalls, toys, tools, stones, roots and the like.

The normal life is 3 to 6 weeks when used under favorable conditions. Refer to *Replace the blades on page 41* on how to replace the blades.

Note: Working with blunt blades gives a poorer mowing result. The grass is not cut cleanly and more energy is needed resulting in the product not mowing such a large area.

5.2 Clean the product



CAUTION: Never use a high-pressure washer to clean the product. Never use solvents for cleaning.

The product does not operate satisfactorily in slopes if the wheels are blocked with grass. Use a soft brush to clean the product.

Husqvarna recommends to use a special cleaning and maintenance kit, available as accessory. Speak to your Husqvarna representative for more information.

5.2.1 Chassis and blade disc

Inspect the blade disc and blades once a week.

1. Push the **STOP** button.
2. Set the **Main switch** to position *0*.
3. Lift the product onto its side.
4. Clean the blade disc and chassis using for example a dish brush. At the same time, check that the blade disc rotates freely in relation to the foot guard. Also, check that the blades are intact and can pivot freely.

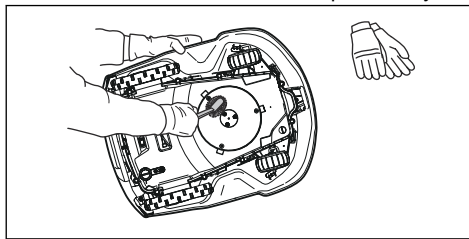

5.2.2 Wheels

Clean around the wheels. Grass on the wheels can impact on how the product performs in slopes.

5.2.3 The body of the product

Use a moist, soft sponge or cloth to clean the body of the product. If the body of the product is dirty, use a mild soap solution to clean it.

5.2.4 Charging station



WARNING: Use the plug to disconnect the charging station before any maintenance, or cleaning of charging station or power supply.

Clean the charging station regularly from grass, leaves, twigs and other objects that may impede docking.

5.3 Replace the blades



WARNING: Use blades and screws of the right type. Husqvarna can only guarantee safety when using original blades. Only replacing the blades and reusing the screw can result in a screw wearing during mowing. The blades can then be propelled from under the body and cause serious injury.

Replace worn or damaged parts for safety reasons. Even if the blades are intact, they should be replaced on a regular basis for the best mowing result and low energy usage. All 3 blades and screws must be replaced at the same time to obtain a balanced cutting system. Use Husqvarna original blades embossed with the crowned H-mark logotype, refer to *Technical data on page 55*.

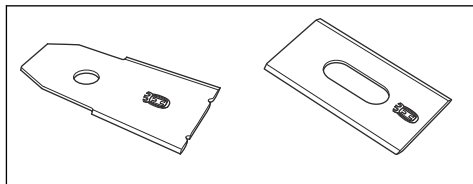

5.3.1 To replace the blades

1. Push the **STOP** button
2. Set the **Main switch** to position 0.

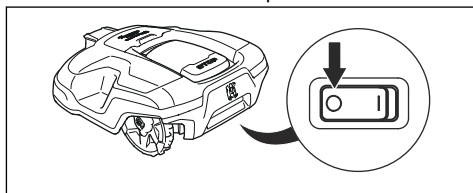

3. Turn the product upside down. Place the product on a soft and clean surface to avoid scratching the body and the hatch.
4. Rotate the skid plate so that its holes align with the screws for the blade.
5. Remove the 3 screws with a screwdriver.

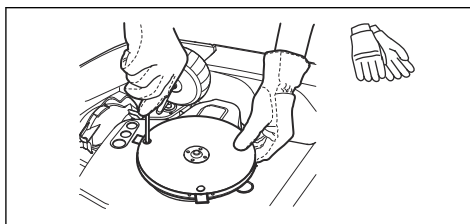

6. Remove the 3 blades.
7. Attach 3 new blades and screws.
8. Make sure that the blades can pivot freely.

5.4 Battery



WARNING: Only charge the product using a charging station which is intended for it. Incorrect use may result in electric shock, overheating or leakage of corrosive liquid from the battery. In the event of leakage of electrolyte flush with water and seek medical help if it comes in contact with the eyes etc.



WARNING: Use only original batteries recommended by the manufacturer. Product safety cannot be guaranteed with other batteries. Do not use non-rechargeable batteries.



CAUTION: The battery must be charged fully before winter storage. If the battery is not fully charged it can be damaged and in certain cases be rendered useless.

If the operating time for the product is shorter than normal between charges, this indicates that the battery is getting old and eventually needs replacing.

Note: Battery life is dependent on the length of the season and how many hours a day the product is operating. A long season or many hours of use a day means that the battery must be replaced more regularly. The battery is fine as long as the product maintains a well-cut lawn.

5.5 Winter service

Take your product to your Husqvarna central service for service prior to winter storage.

Regular winter service will maintain the product in good condition and create the best conditions for a new season without any disruptions.

Service usually includes the following:

- Thorough cleaning of the body, the chassis, the blade disc and all other moving parts.
- Testing of the product's function and components.
- Checking and, if required, replacing wear items such as blades and bearings.
- Testing the product's battery capacity as well as a recommendation to replace battery if necessary.
- If new firmware is available, the product is updated.

6 Troubleshooting

6.1 Introduction - troubleshooting

In this chapter, faults and symptoms are described and can guide you if the product does not operate as expected. More suggestions for steps to take in the event of malfunction or symptoms can be found on www.husqvarna.com.

6.2 Fault messages

The fault messages in the table below are shown in the display of the product. Speak to your Husqvarna representative if the same message shows frequently.

Message	Cause	Action
<i>Wheel motor blocked, left/right</i>	Grass or other object has wrapped around the drive wheel.	Check the drive wheel and remove the grass or other object.
<i>Cutting system blocked</i>	Grass or other object has wrapped around the blade disc.	Check the blade disc and remove the grass or other object.
	The blade disc lies in a pool of water.	Move the product and prevent the collection of water in the work area.
	The grass is too high.	Cut the grass before you install the product. Make sure that the grass is maximum 10 cm / 3.9 in.
<i>Trapped</i>	The product is stuck in a small area behind a number of obstacles.	Check if there are any obstacles which make it hard for the product to move on from this location. Remove the obstacles or create an island around the obstacles. Refer to <i>To make an island on page 18</i> .
<i>Outside working area</i>	The boundary wire connections to the charging station are crossed.	Check that the boundary wire is connected correctly.
	The boundary wire is too close to the edge of the work area.	Check that the boundary wire has been laid according to the instructions. Refer to <i>To examine where to put the boundary wire on page 16</i> .
	The work area slopes too much by the boundary loop.	
	The boundary wire is laid in the wrong direction around an island.	
	Disturbances from metal objects (fences, reinforcement steel) or buried cables close by.	Try moving the boundary wire.
	The product finds it hard to distinguish the signal from another product installation close by.	Put the product in the charging station and generate a new loop signal.

Message	Cause	Action
<i>Empty battery</i>	The product cannot find the charging station.	Change the position of the guide wire. Refer to <i>To install the guide wire on page 22</i> .
	The battery is spent.	Replace the battery. Refer to <i>Battery on page 41</i> .
	The charging station's antenna is defective.	Check if the indicator lamp in the charging station flashes red. Refer to <i>Indicator lamp in the charging station on page 49</i> .
	The charging plates on the product or contact plates on the charging station are corroded.	Clean the charging and contact plates using a fine grade emery cloth. If the problem stays speak to your authorized service technician.
<i>Wrong PIN code</i>	Wrong PIN code has been entered. Five attempts are permitted, and the keypad is then blocked for a period of time.	Enter the correct PIN code. Contact Husqvarna customer service if you forget the PIN code.
<i>No drive</i>	The product has got caught in something and has been slipping.	Free the product and rectify the reason for the lack of drive. If it is due to wet grass, wait until the lawn has dried before using the product.
	The work area includes a steep slope.	Steep slopes should be isolated. Refer to <i>To put the boundary wire in a slope on page 18</i> .
	The guide wire is not laid diagonally in the slope.	Make sure that the guide wire is installed diagonally across the slope. Refer to <i>To make a secondary area on page 19</i> .
<i>Wheel motor overloaded, left/right</i>	Grass or other object is wrapped around the drive wheel.	Check the drive wheel and remove grass or object.
<i>Collision sensor problem, front/rear</i>	The product body can not move freely around its chassis.	Check that the product body can move freely around its chassis. If the problem stays speak to your authorized service technician.
<i>Alarm! Mower switched off</i>	The alarm is activated because the product had been switched off.	Adjust the security level in the <i>Security</i> menu. Refer to <i>To set the security level on page 25</i> .
<i>Alarm! Mower stopped</i>	The alarm is activated because the product has been stopped.	
<i>Alarm! Mower lifted</i>	The alarm is activated because the product has been lifted.	
<i>Alarm! Mower tilted</i>	The alarm is activated because the product has been tilted.	

Message	Cause	Action
<i>Charging station blocked</i>	The contact between the charging plates on the product on the and contact plates on the charging station may be poor and the product has made a number of attempts to charge.	Put the product in the charging station and check that the charging plates and contact plates make good contact.
	An object is in the way of the product that prevents it to enter the charging station.	Remove the object.
	The charging station is tilted or bent.	Put the baseplate on level ground.
	The guide wire is not installed correctly.	Check if the guide wire is installed according to the instructions. Refer to <i>To install the guide wire on page 22</i> .
<i>Stuck in charging station</i>	There is an object in the way of the product preventing it from leaving the charging station.	Remove the object.
<i>Upside down</i>	The product is leaning too much or has turned over.	Turn the product the right way up.
<i>Needs manual charging</i>	The product is set to the <i>Secondary area</i> operating mode.	Put the product in the charging station.
<i>Next start hh:mm</i>	The schedule setting prevents the product from operating.	Change the schedule settings. Refer to <i>Schedule on page 24</i> .
	The rest period is in progress. The product has an inbuilt standby period according to the Standby time table.	This behavior is normal and no action is required.
	The clock or date in the product is not correct.	Set the time. Refer to <i>To set the time & date on page 32</i> .
<i>Today's mowing completed</i>	The product has an inbuilt standby period according to the Standby time table.	This behavior is normal and no action is required. Refer to <i>Schedule and Standby on page 37</i> .
<i>Lifted</i>	The lift sensor has been activated as the product has been lifted.	Check that the product body can move freely around its chassis. Remove or create an island around objects that can cause the chassis to be lifted. If the problem stays speak to your authorized service technician.
<i>Wheel drive problem, right/left</i>	Grass or other object is wrapped around the drive wheel.	Clean the wheels and around the wheels.

Message	Cause	Action
<i>Electronic problem</i>	Temporary electronic or firmware related issue in the product.	Restart the product. If the problem stays speak to your authorized service technician.
<i>Loop sensor problem, front/rear</i>		
<i>Tilt sensor problem</i>		
<i>Temporary problem</i>		
<i>Invalid sub-device combination</i>		
<i>Temporary battery problem</i>		
<i>Charging system problem</i>	Incorrect type of battery.	Use original batteries recommended by the manufacturer.
<i>Battery problem</i>	Temporary battery or firmware related issue in the product.	Restart the product. If the problem stays speak to your authorized service technician.
	Incorrect type of battery.	Use original batteries recommended by the manufacturer.
<i>Battery temperature outside limits</i>	The temperature in the battery is too high or too low to start operation.	No action. The product will start to operate when the temperature is in limits.
<i>Charging current too high</i>	Wrong or faulty power supply unit.	Restart the product. If the problem stays speak to your authorized service technician.
<i>Connectivity problem</i>	Potential problem on the connectivity circuit board in the product.	Restart the product. If the problem stays speak to your authorized service technician.
<i>Connectivity settings restored</i>	The connectivity settings was restored due to a fault.	Check and change the settings if needed.
<i>Poor signal quality</i>	The connectivity circuit board in the product is assembled upside down, or the product itself is tilted or upside down.	Make sure that the product is not upside down or tilted. If the problem stays speak to your authorized service technician.

Message	Cause	Action
<i>No loop signal</i>	The power supply or low-voltage cable is not connected.	If the LED status indicator on the charging station is not lit, it shows that there is no power. Examine the wall socket connection and the residual-current device. Make sure that the low-voltage cable is connected to the charging station.
	The power supply or low-voltage cable is damaged or not connected.	Replace the power supply or low-voltage cable.
	The boundary wire is not connected to the charging station.	Check that the boundary wire connectors are fitted properly to the charging station. Replace connectors if damaged. Refer to <i>To install the boundary wire on page 21</i> .
	The boundary is wire broken.	Do a check of the LED status indicator on the charging station. If it shows break in the boundary wire, replace the damaged section with a new loop wire and splice using an original coupler.
	<i>ECO mode</i> is activated and the product has attempted to start outside the charging station.	Put the product in the charging station, start the product and close the hatch.
	The boundary wire is crossed on its way to and from an island.	Check that the boundary wire is laid according to instructions, e.g. in the right direction around the island. Refer to <i>To make an island on page 18</i> .
	The pairing between the product and the charging station is lost.	Put the product in the charging station and generate a new loop signal. Refer to <i>To create a New loop signal on page 25</i> .
	Disturbances from metal objects (fences, reinforcement steel) or buried cables close by.	Try to move the boundary wire and/or make islands in the work area to increase the signal strength.
<i>Mower tilted</i>	The product is tilted more than the maximum angle.	Move the product to a flat area.
<i>Connection NOT changed</i>	Failed to change loop signal.	Try to create a <i>New loop signal</i> several times. Refer to <i>To create a New loop signal on page 25</i> . If the problem stays speak to your authorized service technician.
<i>Cutting system imbalance</i>	Too few or too many blades.	Do a check of the blades on the blade disc.

6.3 Information messages

The information messages in the table below are shown in the display of the product. Speak to your Husqvarna representative if the same message shows frequently.

Message	Cause	Action
<i>Low battery</i>	The product cannot find the charging station.	Change the position of the guide wire. Refer to <i>To install the guide wire on page 22</i> .
		Check the settings. Refer to <i>To set how the product finds the charging station on page 29</i> .
	The battery is spent.	Replace the battery. Refer to <i>Battery on page 41</i> .
	The charging station's antenna is defective.	Check if the indicator lamp in the charging station flashes red. Refer to <i>Indicator lamp in the charging station on page 49</i> .
	The charging plates on the product or contact plates on the charging station are corroded.	Clean the charging and contact plates using a fine grade emery cloth. If the problem stays speak to your approved servicing dealer.
<i>Settings restored</i>	Confirmation that <i>Reset all user settings</i> has been carried out.	No action.
<i>Guide not found</i>	The guide wire is not connected to the charging station.	Check that the guide wire connector is tightly connected to the charging station. Refer to <i>To install the guide wire on page 22</i> .
	Break in the guide wire.	Find out where the break is and rectify it.
	The guide wire is not connected to the boundary loop.	Check that the guide wire is connected correctly to the boundary loop. Refer to <i>To install the boundary wire on page 21</i> .
<i>Guide calibration failed</i>	The product has failed to calibrate the guide wire.	Check that the guide wire is installed according to the instructions. Refer to <i>To install the guide wire on page 22</i> .
<i>Guide calibration done</i>	The product has succeeded to calibrate the guide wire.	No action.
<i>Connection changed</i>	New loop signal successfully changed.	No action.

6.4 Indicator lamp in the charging station

The indicator lamp in the charging station must show a solid or flashing green light for a correct installation. If not, follow the instructions in the troubleshooting guide below.

You can also find information on www.husqvarna.com. Speak to your Husqvarna customer service for more information.

Light	Cause	Action
<i>Green solid light</i>	Good signals	No action required
<i>Green flashing light</i>	The signals are good and <i>ECO mode</i> is activated.	No action required. For more information on <i>ECO mode</i> . Refer to <i>ECO mode on page 31</i> .
<i>Blue flashing light</i>	The boundary loop is not connected to the charging station.	Check that the boundary wire connectors are fitted properly to the charging station. Refer to <i>To install the boundary wire on page 21</i> .
	Break in the boundary loop.	Find out where the break is. Replace the damaged section of the loop with a new loop wire and splice using an original coupler.
<i>Red flashing light</i>	Interruption in the charging station's antenna.	Contact Husqvarna customer service.
<i>Red solid light</i>	Fault in the circuit board or incorrect power supply in the charging station. The fault should be rectified by an authorized service technician.	Contact Husqvarna customer service.

6.5 Symptoms

If your product does not work as expected, follow the symptoms guide below.

There is a FAQ (Frequently Asked Questions) on www.husqvarna.com which provides more detailed answers to a number of standard questions. Contact Husqvarna customer service if you still cannot find the reason for the fault.

Symptoms	Cause	Action
The product has difficulty docking.	The guide wire is not laid in a long straight line that is far enough out from the charging station.	Check that the charging station has been installed according to the instructions in <i>To examine where to put the guide wire on page 19</i>
	The guide wire is not inserted in the slot under the charging station.	Make sure that the guide wire is in the correct position below the charging station. Refer to <i>To install the guide wire on page 22</i> .
	The charging station is not on a level surface.	Place the charging station on a surface that is entirely level. Refer to <i>To examine where to put the charging station on page 15</i> .
The product runs at the wrong time	The clock or the date in the product is not correct.	Set the clock or date. Refer to <i>To set the time & date on page 32</i> .
	The start and stop times for mowing are incorrect.	Change the <i>Schedule</i> settings. Refer to <i>To set the schedule on page 24</i> .
The product vibrates.	Damaged blades lead to imbalance in the cutting system.	Inspect the blades and screws and replace them if necessary. Refer to <i>Replace the blades on page 41</i> .
	Too many blades in the same position lead to imbalance in the cutting system.	Check that only one blade is fitted at each screw.
	Different versions (thickness) of blades are used.	Check if the blades are of different versions.
The product runs, but the blade disc does not rotate.	The product searches for the charging station, or is reversing out of the charging station.	No action. The blade disc does not rotate when the product is searching for the charging station.
The product mows for shorter periods than usual between charges.	Grass or other foreign object blocks the blade disc.	Remove and clean the blade disc. Refer to <i>Chassis and blade disc on page 40</i> .
	The battery is spent.	Replace the battery. Refer to <i>Battery on page 41</i> .
	Dull blades. More energy is needed when cutting the grass.	Replace the blades. Refer to <i>Replace the blades on page 41</i> .

Symptoms	Cause	Action
Both the mowing and charging times are shorter than usual.	The battery is spent.	Replace the battery. Refer to <i>Battery on page 41</i> .
The product is parked for hours in the charging station.	The product has an inbuilt standby period according to the Standby time table. Refer to <i>Schedule and Standby on page 37</i> .	No action.
	The hatch is closed but the START button is not pushed.	Push the STOP button to open the hatch. Enter the PIN code and confirm with the OK button. Push the START button and then close the hatch.
	Parking mode is activated.	Change the operating mode. Refer to <i>Operating mode Start on page 36</i> .
	The product is not allowed to operate if the battery temperature is too high or too low.	Check that the charging station is placed in an area with protection from the sun.
Uneven mowing results.	The product works too few hours per day.	Increase the mowing time. Refer to <i>Schedule on page 24</i> .
	The shape of the work area requires the use of <i>Lawn coverage</i> function for the product to find its way to all remote areas.	Steer the product to a remote area. Refer to <i>Lawn Coverage on page 27</i> .
	The <i>How often?</i> setting is incorrect in relation to the layout of the work area.	Check that the correct <i>How often?</i> value is selected.
	The work area is too large.	Try limiting the work area or extending the schedule. Refer to <i>Schedule on page 24</i> .
	Dull blades.	Replace all the blades. Refer to <i>Replace the blades on page 41</i> .
	Long grass in relation to the set cutting height.	Increase the cutting height and then successively lower it.
	Accumulation of grass by the blade disc or around the motor shaft.	Check that the blade disc rotates freely and easily. If not, screw off the blade disc and remove grass and foreign objects. Refer to <i>Chassis and blade disc on page 40</i> .

6.6 Find breaks in the loop wire

Breaks in the loop wire are usually the result of unintentional physical damage to the wire such as when gardening with a shovel. In countries with ground frost, also sharp stones that move in the ground can damage the wire. Breaks can

also occur due to the wire being stretched excessively during installation.

Mowing the grass too low right after the installation can damage wire insulation. Damage to the insulation may not cause disruptions until several weeks or months later. To avoid this,

always select the maximum cutting height the first weeks after installation and then lower the height one step at a time every second week until the desired cutting height has been reached.

A defective splicing of the loop wire can also lead to disruptions several weeks after the splice was done. A faulty splice can, for example, be the result of the original coupler not being pressed together hard enough with a pair of pliers, or that a coupler of lower quality than the original coupler has been used. Please first check all known splices before further troubleshooting is done.

A wire break can be located by gradually halving the distance of the loop where the break may have occurred until there is only a very short section of the wire left.

The following method does not work if *ECO mode* is activated. Make sure first that *ECO mode* is switched off. Refer to *ECO mode on page 31*.

1. Check that the indicator lamp in the charging station flashes blue, which indicates a break in the boundary loop. Refer to *Indicator lamp in the charging station on page 49*.

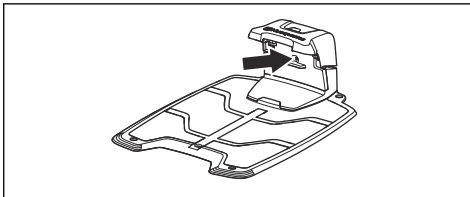

2. Check that the boundary wire connections to the charging station are properly connected and not damaged. Check that the indicator lamp in the charging station is still flashing blue.

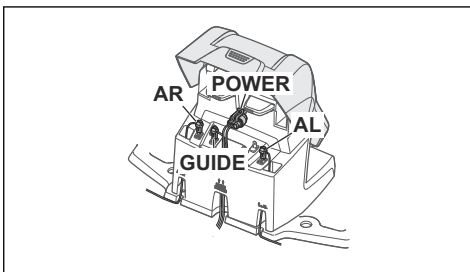

3. Switch the connections between the guide wire and the boundary wire in the charging station.

Start by switching connection and .

If the indicator lamp has a solid green light, then the break is somewhere on the boundary wire between and the point where the guide wire is connected to the boundary wire (thick black line in the illustration).

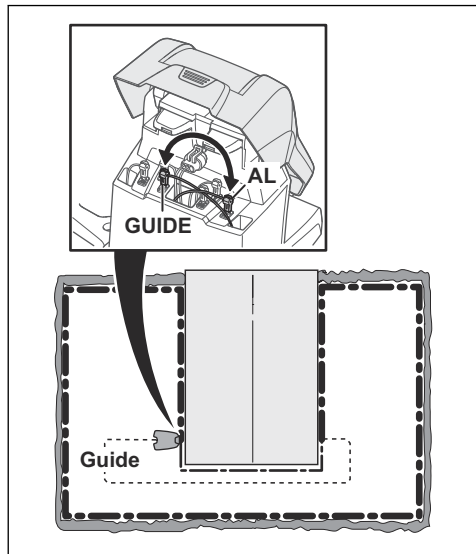

To rectify the fault you will need boundary wire, connector(s) and coupler(s):

a) If the suspected boundary wire is short then it is easiest to exchange all of the boundary wire between and the point where the guide wire is connected to the boundary wire (thick black line).

b) If the suspected boundary wire is long (thick black line) then do as follows: Put and back to their original positions. Then disconnect . Connect a new loop wire to . Connect the other end of this new loop wire at the middle of the suspected wire section.

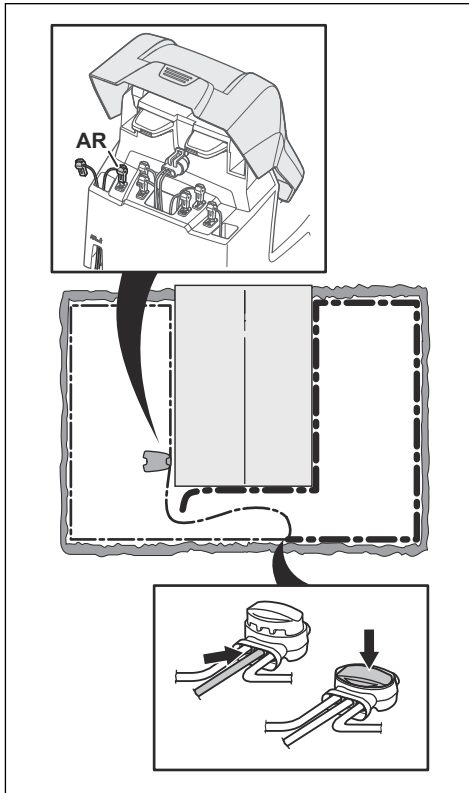

If the indicator lamp now is green, then the break is somewhere in the wire between the disconnected end to the point where the new wire is connected (thick black line below). In that case, move the connection for the new wire closer to the disconnected end (roughly at the middle of the suspected wire section) and check again if the indicator lamp is green.

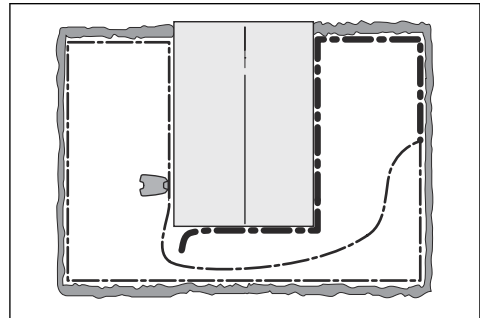

Continue until only a very short section of the wire remains which is the difference between a solid green light and a flashing blue light. Then follow instruction in step 5 below.

4. If indicator lamp still flashes blue in step 3 above: Put and back in their original positions. Then switch and . If indicator lamp now is lit with a solid green light then disconnect and connect a new boundary wire to . Connect the other end of this new wire at the middle of the suspected wire section. Follow the same approach as in 3a) and 3b) above.
5. When the break is found, the damaged section must be replaced with a new wire. Always use original couplers.

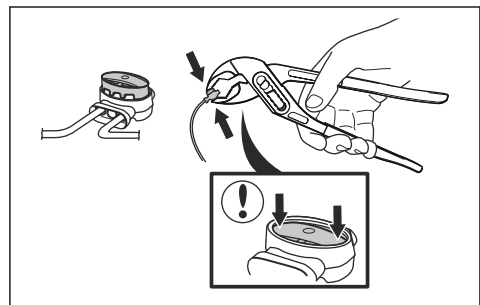

7 Transportation, storage and disposal

7.1 Transportation

The supplied Li-ion batteries obey the Dangerous Goods Legislation requirements.

- Obey all applicable national regulations.
- Obey the special requirement on package and labels for commercial transportations, including by third parties and forwarding agents.

7.2 Storage

- Fully charge the product. Refer to *To charge the battery on page 38*.
- Set the **Main switch** to position 0. Refer to *To switch off the product on page 37*.
- Clean the product. Refer to *Clean the product on page 40*.
- Keep the product in a dry, frost free space.
- Keep the product with all wheels on level ground during storage, or use a wall hanger.
- If you keep the charging station indoors, disconnect and remove the power supply and all the connectors from the charging station. Put the end of each connector wire in a connector protection box.

Note: If you keep the charging station outdoors, do not disconnect the power supply and the connectors.

- Contact Husqvarna sales representative about what accessories are available for your product.

7.3 Disposal

- Obey the local recycling requirements and applicable regulations.
- For questions about how to remove the battery, refer to *To remove the battery on page 54*.

7.3.1 To remove the battery



CAUTION: Only remove the battery when you dispose the product. When you remove the warranty seal, the Husqvarna warranty is no longer applicable.

1. Disconnect the product with the **Main switch**. Refer to *To switch off the product on page 37*.
2. Pull out the grommet on the charging cable at the very front of the product, and carefully remove the connector.
3. Lift the cover, one corner at a time.
4. Remove the 14 screws with a Torx 20.

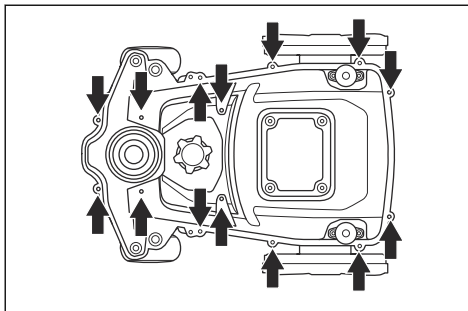

5. Lift the rear edge of the top section of the chassis.
6. Disconnect the cable from the main circuit board.
7. Remove the top section of the chassis.
8. Remove the 2 screws that holds the battery with a Torx 20.

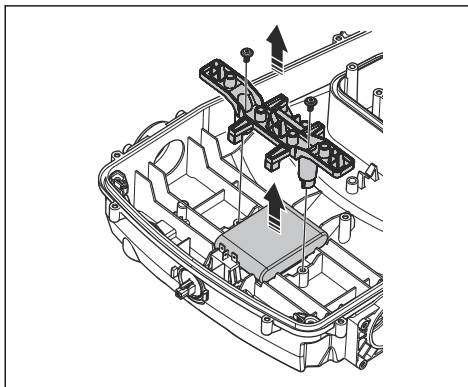

9. Disconnect the battery cable from the main circuit board.

8 Technical data

8.1 Technical data

Dimensions	Automower® 310	Automower® 315	Automower® 315X
Length, cm / in.	63 / 24.8	63 / 24.8	63 / 24.8
Width, cm / in.	51 / 20.1	51 / 20.1	51 / 20.1
Height, cm / in.	25 / 9.8	25 / 9.8	25 / 9.8
Weight, kg / lbs	9.2 / 20	9.2 / 20	10.1 / 22

Electrical system	Automower® 310	Automower® 315	Automower® 315X
Battery, Lithium-Ion 18 V/2.1 Ah Art. No.	584 85 28-01, 584 85 28-02	584 85 28-01, 584 85 28-02	584 85 28-01, 584 85 28-02
Battery, Lithium-Ion 18 V/2.0 Ah Art. No.	584 85 28-03, 590 21 42-02, 593 11 40-01, 593 11 40-02	584 85 28-03, 590 21 42-02, 593 11 40-01, 593 11 40-02	584 85 28-03, 590 21 42-02, 593 11 40-01, 593 11 40-02
Battery, Lithium-Ion 18.25 V/2.0 Ah Art. No.	584 85 28-04, 590 21 42-03	584 85 28-04, 590 21 42-03	584 85 28-04, 590 21 42-03
Power supply, V/28 V DC	100-240	100-240	100-240
Low voltage cable length, m / ft	10 / 33	10 / 33	10 / 33
Mean energy consumption at maximum use	8 kWh/month in a 1000 m ² / 1196 yd ² work area	10 kWh/month in a 1500 m ² / 1794 yd ² work area	10 kWh/month in a 1600 m ² / 1914 yd ² work area
Charge current, A DC	1.3	1.3	1.3
Type of Power Supply Unit	FW7312, ADP-40BR		
Average mowing time, min	70	70	70
Average charging time, min	60	60	60

Boundary wire antenna	Automower® 310	Automower® 315	Automower® 315X
Operating Frequency Band, Hz	300-80000	300-80000	300-80000
Maximum Radio-frequency power, mW @60m ⁵	<25	<25	<25

⁵ Maximum active output power to antennas in the frequency band in which the radio equipment operates.

Noise emissions measured in the environment as sound power ⁶	Automower® 310	Automower® 315	Automower® 315X
Measured sound power noise level, dB (A)	58	58	58
Guaranteed sound power noise level, dB (A)	60	60	60
Sound pressure noise level at the operator's ear, dB (A) ⁷	47	47	47

The noise emission declarations conforms to EN 50636-2-107:2015

Mowing	Automower® 310	Automower® 315	Automower® 315X
Cutting system	3 pivoted cutting blades		
Blade motor speed, rpm	2300	2300	2300
Power consumption during cutting, W +/- 20 %	25	25	25
Cutting height, cm / in.	2-6 / 0.8-2.4	2-6 / 0.8-2.4	2-6 / 0.8-2.4
Cutting width, cm / in.	22 / 8.7	22 / 8.7	22 / 8.7
Narrowest possible passage, cm / in.	60 / 24	60 / 24	60 / 24
Maximum angle for work area, %	40	40	40
Maximum angle for boundary wire, %	15	15	15
Maximum length boundary wire, m / ft	800 / 2600	800 / 2600	800 / 2600
Maximum length guide loop ⁸ , m / ft	400 / 1300	400 / 1300	400 / 1300
Working capacity, m ² / yd ² , +/- 20%	1000 / 1196	1500 / 1794	1600 / 1914

⁶ Noise emissions in the environment measured as sound power (L_{wa}) in conformity with EC directive 2000/14/EC and New South Wales legislation (Protection of the Environment Operations Regulation 2017, Noise Control). The guaranteed sound power level includes variation in production as well as variation from the test code with 1-3 dB(A). Noise emission data can be found on the rating label and in the Technical data chapter.

⁷ Sound pressure noise uncertainties K_{pA} , 2-4 dB (A)

⁸ A guide loop consist of the guide wire and the boundary wire from the junction to the right connection on the charging station.

IP-classification	Automower® 310	Automower® 315	Automower® 315X
Robotic lawn mower	IPX4	IPX4	IPX4
Charging station	IPX1	IPX1	IPX1
Power supply	IPX4	IPX4	IPX4

Frequency Band Support	
Automower® Connect 2G	GSM 850 MHz, E-GSM 900 MHz, DCS 1800 MHz, PCS 1900 MHz
Automower® Connect 3G	Band 19 (800 MHz), Band 5 (850 MHz), Band 8 (900 MHz), Band 2 (1900 MHz), Band 1 (2100 MHz)
Automower® Connect 4G	Band 12 (700 MHz), Band 17 (700 MHz), Band 28 (700 MHz), Band 13 (700 MHz), Band 20 (800 MHz), Band 26 (850 MHz), Band 5 (850 MHz), Band 19 (850 MHz), Band 8 (900 MHz), Band 4 (1700 MHz), Band 3 (1800 MHz), Band 2 (1900 MHz), Band 25 (1900 MHz), Band 1 (2100 MHz), Band 39 (1900 MHz)

Power Class		
Bluetooth® Output power	8 dBm	
Automower® Connect 2G	Power Class 4 (for GSM/E-GSM)	33 dBm
	Power Class 1 (for DCS/PCS)	30 dBm
	Power Class E2 (for GSM/E-GSM bands)	27 dBm
	Power Class E2 (for DCS/PCS bands)	26 dBm
Automower® Connect 3G	Power Class 3	24 dBm
Automower® Connect 4G	Power Class 3	23 dBm

Husqvarna AB does not guarantee full compatibility between the product and other types of wireless systems such as remote controls, radio transmitters, hearing loops, underground electric animal fencing or similar.

The products are made in England or the Czech Republic. See information on the rating plate. Refer to *Product overview Automower® 310/315/315X on page 4*.

8.2 Registered trademarks

The *Bluetooth®* word mark and logos are registered trademarks owned by *Bluetooth SIG, inc.* and any use of such marks by Husqvarna is under license.

9 Warranty

9.1 Warranty terms

Husqvarna® warranty covers this product's functionality for a period of 2 years from date of purchase. The warranty covers serious faults relating to materials or manufacturing faults. Within the warranty period, we will replace the product or repair it at no charge if the following terms are met:

- The product and the charging station may only be used in compliance with the instructions in this Operator's Manual. This manufacturer's warranty does not affect warranty entitlements against the dealer/retailer.
- End-users or non-authorized third parties must not attempt to repair the product.

Examples of faults which are not included in the warranty:

- Damage caused by water seepage from using a high-pressure washer, or from being submerged under water, for example when heavy rain forms pools of water.
- Damage caused by lightning.
- Damage caused by improper battery storage or battery handling.
- Damage caused by using a battery that is not a Husqvarna original battery.
- Damage caused by not using Husqvarna original spare parts and accessories, such as blades and installation material.
- Damage to the loop wire.
- Damage caused by non-authorized changing or tampering with the product or its power supply.

The blades and wheels are seen as disposable and are not covered by the warranty.

If an error occurs with your Husqvarna product, please contact Husqvarna customer service for further instructions. Please have the receipt and the product's serial number at hand when contacting Husqvarna customer service.

10 EC Declaration of Conformity

10.1 EC Declaration of Conformity

Husqvarna AB, SE-561 82 Huskvarna, Sweden, tel: +46-36-146500, declares that the Husqvarna® Automower® 310, Husqvarna® Automower® 315 and Husqvarna® Automower® 315X with serial numbers dating 2019 week 45 and onwards (the year and week is clearly stated on the rating plate, followed by the serial number), comply with the requirements of the COUNCIL'S DIRECTIVE:

- Directive "relating to machinery" **2006/42/EC**.
 - Particular requirements for robotic battery powered electrical lawnmowers **EN 50636-2-107: 2015**.
 - Electromagnetic fields **EN 62233: 2008**.
- Directive on "restriction of use of certain hazardous substances" **2011/65/EU**.
 - The following standard is applied: **EN 50581:2012**
- Directive "relating to noise emissions from outdoor equipment" **2000/14/EC**. Refer to *Technical data on page 55* for information regarding noise emissions and the cutting width.

For Automower® 310/315 (certificate 01/901/225) and Husqvarna® Automower® 315X (certificate 01/901/286): The notified body 0404, RISE SMP Svensk Maskinprovning AB, Box 7035, SE-750 07 Uppsala, Sweden, has issued a report regarding the assessment of conformity according to annex VI to the Council's Directive of May 8, 2000 "relating to noise emissions into the environment" 2000/14/EC.

- Directive "relating to radio equipment" **2014/53/EU**. Type examination certificate is issued for examination to Directive 2014/53/EU. The following standards have been applied:

- **ETSI EN 303 447 V1.1.1**

Electromagnetic compatibility:

- **ETSI EN 301 489-1 V2.2.0**
- **EN 61000-6-1:2007**

- **EN 61000-6-3:2007/A1:2011**

For Husqvarna® Automower® 310, Husqvarna® Automower® 315 and Husqvarna® Automower® 315X, equipped with the Automower® Connect module also:

- **ETSI EN 301 489-19 V2.1.0**
- **ETSI EN 301 489-52 V1.1.1**
- **ETSI EN 301 511 V12.5.1**
- **ETSI EN 301 908-2 V11.1.1**

For Husqvarna® Automower® 310, Husqvarna® Automower® 315 and Husqvarna® Automower® 315X equipped with Bluetooth® also:

- **ETSI EN 300 328 V2.1.1**
- **ETSI EN 301 489-17 V3.1.1**



Huskvarna, 2020-02-01

Lars Roos

Global R&D Director, Electric category

(Authorized representative for Husqvarna AB and responsible for technical documentation.)



Husqvarna[®]

AUTOMOWER[®] is a trademark owned by Husqvarna AB.
Copyright[®] 2020 HUSQVARNA. All rights reserved.

www.husqvarna.com

Original instructions

1142215-26



2020-03-09