



LEHNER[®]
Streuen & Dosieren mit 12 Volt

Operating manual with parts list

POLARO[®]



Last updated: March 2022

Serial number:

Original operating manual

Publisher's information

LEHNER Maschinenbau GmbH

Häuslesäcker 14

D-89198 Westerstetten

Tel.: +49 7348 95 96 22

Fax: +49 7348 959 640

www.lehner.eu

info@lehner.eu

This document must not be distributed, duplicated or utilised, nor may its content be communicated without express permission. Compensation will be sought for all breaches. All rights reserved in the event of patent, utility model or design registration.

English

Table of contents

1	What you should know.....	5
1.1	Foreword.....	5
1.2	About this operating manual.....	5
1.3	Warnings.....	5
1.4	Description of the POLARO®.....	5
1.5	Technical data for POLARO®.....	6
1.6	Intended use.....	6
1.7	Reasonably predictable misuse.....	6
1.8	Warranty.....	6
1.9	About your safety.....	7
2	Mounting and start-up.....	8
2.1	Mounting the frame.....	8
2.2	Mounting the hopper.....	8
2.3	Electrical connection.....	9
2.4	Fill the spreading material hopper.....	10
3	Operating the POLARO®.....	11
3.1	Controls on the control panel.....	11
3.2	Switching spreading disc and agitator on and off.....	11
3.3	Setting the speed.....	12
3.4	Adjusting the slider opening.....	12
3.5	Opening/closing the slide.....	12
3.6	Setting the spreading width.....	13
4	Settings.....	14
4.1	Turning down.....	14
4.2	Determining the spreading width.....	14
5	Maintenance/Cleaning.....	15
5.1	Maintenance.....	15
5.2	Cleaning.....	16
5.3	Transport and storage.....	16
6	Appendix.....	17
6.1	EC Declaration of conformity.....	17
6.2	Identification.....	19
6.3	Distribution box reference list.....	20
6.4	Parts list POLARO®.....	21
7	POLARO® error message list.....	23

8	Care and maintenance instructions POLARO®.....	24
9	Spring steel.....	25
10	Attaching POLARO® to the Husqvarna Rider P 500 series.....	27

1 What you should know

1.1 Foreword

Congratulations on purchasing the **POLARO**[®], a high-quality and innovative product. Thank you for this expression of confidence.

Thanks to its advanced design, meticulous material selection, state-of-the-art manufacturing techniques and the precision work of our employees, this equipment meets all efficiency, quality, reliability and value requirements.

Maintaining and servicing in accordance with the operating instructions ensures the safety of the device and maintains the value of your **POLARO**[®].

1.2 About this operating manual

This operating manual is an important component of the **POLARO**[®] and must always be kept close to hand. It must be read, understood and followed by everybody who works with the **POLARO**[®].

Keep the operating manual in a safe place. If you sell your **POLARO**[®], always pass this operating manual on to the buyer.

1.3 Warnings

Warnings in this operating manual are identified as follows:



Danger!

Warning of immediate danger.

Non-observance of appropriate measures may result in death or severe personal injury or serious material damage.



Warning!

Warning of possible danger.

Death or severe personal injury is possible.



Caution!

Warning of possible dangerous situations.

Minor personal injury or damage to property is possible.

1.4 Description of the **POLARO**[®]

The **POLARO**[®] is a spreader for spreading winter salt, grit, sand and granulated fertilisers. It consists of a solid frame, a hopper for the material to be spread and the electrical components.

The frame includes the spreading disc with slider/dosing equipment. The electrical components comprise the drive motor, speed sensor, distribution control box, control console cable, control cable, battery cable, control console and breakaway safety cut-off.

A separate motor drives a slow-running agitator for grit, sand, smooth flowing salt or granulated fertiliser. As an alternative for slow-flowing or damp salt, a special saline agitator is available as an accessory. This agitator is mounted in an upright position in the hopper.

The speed of the spreading plate and disc can be regulated from a control panel in the driver's cab.



Notice

The **POLARO**[®] can be mounted on the front or rear of the carrying vehicle.

Note the gross weight of the filled spreader.

1.5 Technical data for POLARO®

	POLARO® 70	POLARO® 110	POLARO® 170
Dimensions L/W/H	570/485/870 mm	570/485/1050 mm	700/626/1070 mm
Net weight	29 kg	138 kg	42 kg
Capacity	70 l	110 l	170 l
Salt capacity	90 kg	130 kg	220 kg
Operating voltage	12 - 15 Volt		
Fuse	25 Ampere		
Power of drive motor (spreading disc)	60 W		
Power of mixer motor	150 W		
Speed range	40 to 600 rpm		
Standard speed of agitator	54 rpm		
Speed of saline agitator	27 - 29 rpm		
Power consumption of motor	Starting: up to 25 A Normal operation: up to 13 A		
Operating temperature	-10°C to +70°C		
Storage temperature	-30 °C to +70°C		
Length of battery cable	3 m	5 m	5 m
Length of control panel cable	2 m		
Length of control cable	3.3 m	6 m	6 m

1.6 Intended use

The **POLARO®** is a spreader for spreading winter salt, grit, sand and granulated fertilisers.

1.7 Reasonably predictable misuse

POLARO® must only be used on approved carrier vehicles with suitable on-board electrical systems and sufficient structural integrity.

POLARO® must only be used for approved media. The device must not be used for spreading crop protection products.

1.8 Warranty

Subject to proper use, **LEHNER Maschinenbau GmbH** provides a 12-month warranty period on the **POLARO®**. Prior to any work being carried out, repairs under guarantee must be agreed with **LEHNER Maschinenbau GmbH**.

For replacement parts, additional expenses are charged for any changes made to cables and plugs by the customer.

Replacement parts are to be returned carriage paid.

Any changes to cable or plug connections without factory approval automatically invalidate the entire guarantee. Rusted bearings are not subject to the manufacturer's warranty. Motors must not be opened or dismantled.

On receipt:

Check your **POLARO®** for any damage caused in transit.

Any such damage must be reported to the manufacturer within 24 hours of receipt.

1.9 About your safety

Read through this operating manual carefully before starting operation. Comply with the instructions, warnings and safety information. Always keep this manual to hand at the point of use.

- Observe the accident prevention regulations, safety and operating regulations and the regulations for environmental protection.
- Observe all applicable standards and guidelines.
- Observe the safety instructions.
- Avoiding injury to personnel or damage to vehicles incurring liability.
- Before operation, check that the hopper is correctly seated in its mounting and that the spreader is safely and correctly attached to the carrier vehicle.
- Do not operate the spreader if there are technical safety defects.
- Make sure that technical safety defects are rectified immediately.
- When travelling on public roads and tracks used by agricultural vehicles, follow the applicable rules of the road.
- There must be no other persons in the spreading zone.
- Switch off the motor before carrying out any troubleshooting and cleaning work.
- Disconnect the electrical power supply for maintenance work.
- Do not reach into the hopper during operation.
- Never reach into the rotating or blocked spreading disk whilst the motor is running.
- It is essential to comply with the instructions of the spreading material manufacturer in question.
- Spreading tables and additional information about the spreading material used can be requested from the spreading material manufacturer in question.
- **LEHNER Maschinenbau GmbH** cannot accept any liability for the storage and application of the spreading material.

2 Mounting and start-up

2.1 Mounting the frame



Warning!
Risk of injury due to weight of component
This can cause injuries.

The spreader is significantly heavier when the hopper is full.
Attention must therefore be paid to the proper mounting of the spreader on the carrier vehicle, and to the carrying capacity of the vehicle tailgate or other panels. If necessary, fit with assistance.



Warning!
Danger of excessive loads!
This can cause injuries.

The load carrying capacity shall be based on the regulations for load bearing equipment.



Warning!
Risk of injury.

Do not operate the spreader if there are technical safety defects.

The **POLARO®** can be mounted on the front or rear of the tractor, off-road vehicle or ATV.

The **POLARO®** can be mounted using an auxiliary bracket. Mounting holes are provided on the back of the framework. for this purpose.

Remove the hopper before mounting the spreader.

The recommended discharge height is 0.40 - 1.00 m.

For information on disassembly, see [Chapter 5.1, "Maintenance"](#).



Notice

Dispose of packaging materials properly or save them for return to the manufacturer.
Retain the special pallet, as it is ideal for transporting the spreader.

2.2 Mounting the hopper





Warning!

Risk of damage to equipment by the use of grit and sand.

Risk of injury and damage to the spreader.

As an alternative for slow-flowing salt, a refined salt agitator is available as an accessory. This agitator is not suitable for grit or sand.

1. Mount the hopper
2. Check that the hopper is well seated in the hopper platform (**see arrow**).
3. Check that the **POLARO®** is securely fixed.

2.3 Electrical connection



Caution!

Danger of short circuit

Ensure that the cables are routed without tension, kinking or chafing, and that they are not routed around sharp edges.



Caution!

Risk of functional failure

Faulty cables or cables with incorrect dimensions can lead to malfunctions and damage to the device. Only use original cables, or ones approved by the manufacturer.

Always push on the cap and lock it to protect electrical connections against damage.



Caution!

Damage to electrical system

During all work on the battery, please comply with the regulations of the vehicle manufacturer in question.

Use only original cables or cables approved by the manufacturer, otherwise the complete warranty will be invalidated. Changes to cables undertaken by the customer shall be subject to additional charges in the event of repairs.



1. Mount support for the control panel in the vehicle cabin.
2. Plug the control panel cable into the three-pin socket **1** of the carrier vehicle.
If such a socket (**1**) is not available, use the battery cable supplied:
 - Connect terminal **2** to the negative terminal of the battery (not to the bodywork).
 - Connect terminal **3** (with fuse **4**) to the positive terminal of the battery.
 - Lay the end of the cable with socket **1** in the carrier vehicle.
3. Plug the spreader cable into the 16-pin plug of the control panel.

To ensure an optimum electrical power supply, use the supplied battery cable.

**Caution!****Danger of short circuit**

Observe the installation instructions of the adapter manufacturer

When fitting a 12/24 V adapters (available as accessory) it is necessary to connect a separate on/off switch in the 24 V supply cable, as the adapter consumes current in the standby mode.

Your device is now ready to operate.

2.4 Fill the spreading material hopper

**Caution!****Health risk**

Comply with the regulations of the spreading material manufacturer.

**Caution!****Risk of injury.**

Never open the hopper or touch the spreading disc when the drive motor is running.

1. Fill the hopper with spreading material immediately before starting work.
2. After filling, close the hopper.

3 Operating the POLARO®

3.1 Controls on the control panel

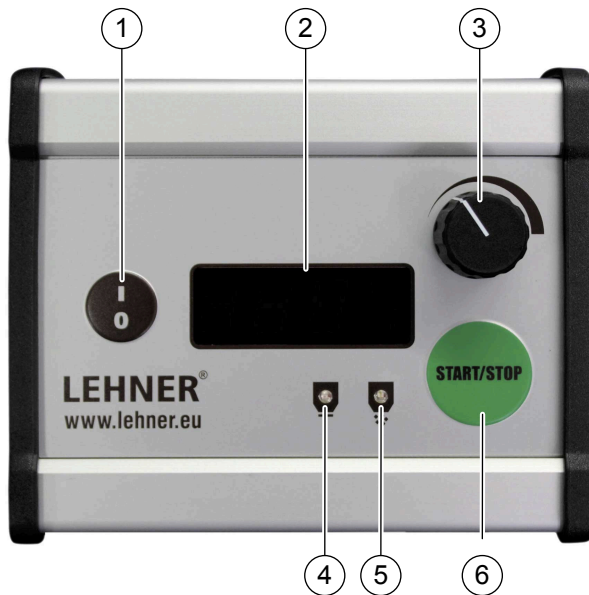

- 1 On/off button
- 2 Display
- 3 Rotary control for spreading disc speed
- 4 Slider closed indicator
- 5 Slider open indicator
- 6 Start/Stop button

3.2 Switching spreading disc and agitator on and off



Danger!
Risk of injury by accident
 When travelling on public roads and streets, observe the road traffic regulations.



Warning!
Risk of injury.
 The drive motor starts immediately when switched on.
 Make sure that no-one is in the danger area when you switch the system on.



Warning!
Risk of injury.
 Do not operate the spreader if there are technical safety defects.



Operate the On/Off button on the front of the control panel.
 The speed of the spreading disc is shown on the display.

170

When the spreader is switched off, the slider closes automatically.

Autostart/automatic freewheeling

If a motor is difficult to start due to heavy loads, the motor starts up to 10 times in alternating directions. For this, the slider must be open so that the material flows out.

If the agitator or spreading plate cannot break free as a result, the motor is automatically switched off. The following message appears on the display:

E2



Warning!

Risk of injury due to unexpected starting of the agitator or spreading disk
Switch off the motor before troubleshooting.

To eliminate the blockage:

1. Switch off the device.
2. Manually turn the spreading disc or empty the hopper.

For more information, see [Chapter 7, "POLARO® error message list"](#).

3.3 Setting the speed



The speed of the spreading disc is infinitely variable using the knob on the control panel.

170

The figure shown on the display is the actual speed of the spreading disc.

3.4 Adjusting the slider opening

1. Make sure that the slider is closed.
2. Set the slider control on the spreader unit to the required dosage.

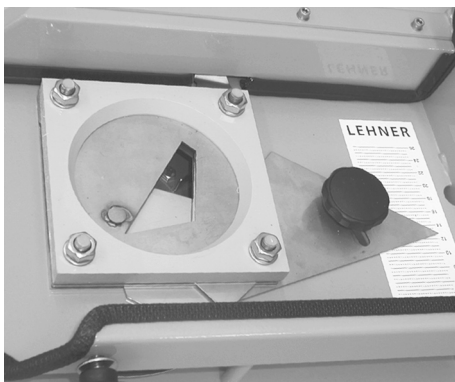

With setting 0 the slider is almost closed and on 20 it is fully open. Within this range, the slider opening is infinitely adjustable.

3.5 Opening/closing the slide

Before opening the slider, make sure that the **POLARO®** is switched off, as otherwise it will immediately start spreading material.



Press the Start/Stop button on the control panel to open or close the slider.

Slider closed



Slider open



This symbol indicates whether the slider is open or closed.

If the spreader is switched off without first closing the slider, the controller automatically closes the slider.

Slider adjustment

The slider elements are spaced to prevent clogging of the spreading material. To prevent the slider from moving across the opening and closing it in the case of vibrations and impacts, a pulse about every 60 seconds regulates the slider position according to the **Open** or **Closed** setting. This only happens, however, when the device is switched on.

For information on troubleshooting, see [Chapter 7, "POLARO® error message list"](#).

3.6 Setting the spreading width

The spreading width depends on the condition of the spreading material and the speed of the spreading disk. The more coarse the spreading material, the larger the possible spreading width.

The manufacturer also offers an optional drive motor for working widths of up to 12 metres. Please enquire about this separately.

4 Settings

4.1 Turning down

1. Put the spreader in the carton or put the carton over the spreader to catch the spreading material.
2. Due to the suction effect, the speed of the spreading disc used in practice must be set.
3. Weigh out the ejected spreading material at various slide positions until the suitable slide position is determined.

4.2 Determining the spreading width

Obtain the reference value for the spreading width from the information supplied by the relevant spreading material supplier.

1. Spread on a firm surface.
2. Weigh spreading material or sweep up a swath lateral to the direction of travel and assess the lateral distribution.

Formulas

$$\frac{\text{Gram/min}}{\text{Speed in m/min} \times \text{Spreading width in m}} = \text{Output in gram/m}^2$$

$$\frac{\text{Gram/min}}{\text{Output in gram/m}^2 \times \text{Spreading width in m}} = \text{Speed in m/min}$$

$$\text{Desired output in gram/m}^2 \times \text{Speed in m/min} \times \text{Spreading width in m} = \text{Gram/min}$$

With setting 0 the slider is almost closed and on 20 it is fully open. Now by turning down again with a modified scale setting, the correct value can be found. When starting spreading, however, the ejected quantity and the lateral distribution must be checked.

5 Maintenance/Cleaning

5.1 Maintenance



Warning!

Risk of injury.

Disconnect the power supply before starting maintenance, repair and cleaning work.



Warning!

Heavy component weight

This can cause injuries.

If necessary, remove with assistance.



Warning!

This can cause injuries.

Always wear goggles, dust mask and gloves when using compressed air for cleaning purposes.

Comply with the regulations of the spreading material manufacturer.

After use, empty the material hopper and clean vehicle with brush or compressed air.

Dosing device/slide

The dosing device and slide should be inspected and cleaned at regular intervals depending on use and the spreading material used.

If using very fine spreading material in particular, the slide unit may clog.

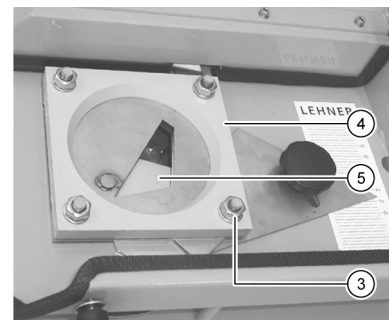
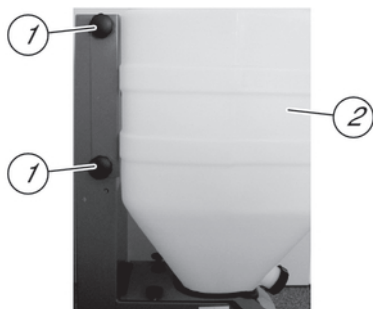

1. Disconnect agitator plug.
2. Unscrew upper and lower knurled screws (1) on both sides.
3. Remove the hopper 2.
4. Unscrew the four nuts (3) using a 17 mm spanner.
5. Remove hopper platform 4 and pull the dosage slider 5 out from the top.
6. Clean the slide unit with a brush or compressed air.
7. Fit parts in reverse order.

Standard lubricant can be applied to the bottom edge to assist with hopper installation.

Drive motor

The drive motor of the spreading disc should be cleaned and greased at the end of the season. This extends the service life of the motor. Carry out the maintenance work correctly, otherwise the manufacturer's warranty may be invalidated.

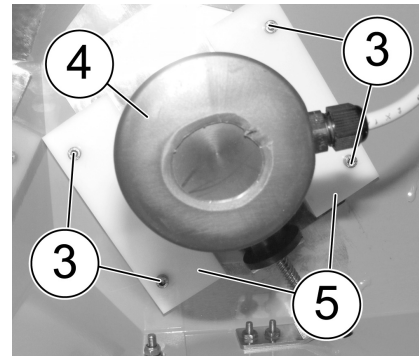
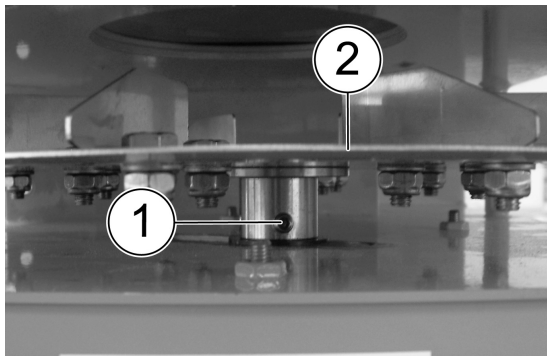

1. Disconnect agitator plug.
2. Undo screw (1) on spreader disc (2) and pull spreader disc (2) out in upward direction.
3. Remove plastic washer (thick).
4. Remove screws 3 from below and remove drive motor 4 with spacer and two guide rails 5.
5. Take plastic washer (thin) off motor shaft.
6. Clean motor shaft and contact surface of plastic washer and apply thin coat of standard copper paste.
7. Fit parts in reverse order.

5.2 Cleaning



Warning!

Risk of injury.

Disconnect the power supply before starting maintenance, repair and cleaning work.



Warning!

Heavy component

This can cause injuries.

Always wear goggles, dust mask and gloves when cleaning. Comply with the regulations of the spreading material manufacturer.

The tank can be almost fully emptied by means of the residual discharge.

1. Unscrew the hopper.
2. Clean spreader and hopper with a brush or compressed air.

5.3 Transport and storage

For transportation, only the trolley available as a special accessory should be used.



Warning!

Risk of injury from stored device falling over.

Place the device on a clean, dry surface with an adequate load capacity. For extended periods, the device may only be stored completely empty.

6 Appendix

6.1 EC Declaration of conformity

EC Declaration of Conformity

In accordance with the EC Machinery Directive 2006/42/EC, app. II, 1.A

Manufacturer:

LEHNER Maschinenbau GmbH
 Häuslesäcker 14
 89198 Westerstetten

Person resident in the Community who is entitled to assemble the relevant technical documents:

Helmut Lehner
 LEHNER Maschinenbau
 Häuslesäcker 14
 89198 Westerstetten

Description and identification of the machine:

Product: POLARO®
 Type: 70/110/170/250

Function: The POLARO® is a spreader for distributing road salt, gravel, sand, fertilizer or granulates of various kinds. It is produced in four sizes. These differ in the hopper capacity, 70, 110, 170 and 250 litres. A manually operated slide sets a constant flow rate of the medium being spread. A separate motor drives a slowly rotating agitator, which can be installed both horizontally and vertically. The agitator keeps the spreading material mobile. The speed of the spreading disc, and thus the spreading width and the slide (open/close), is controlled from the operator's cab by means of a control panel.

It is expressly declared that the machine is in accordance with all relevant provisions of the following EC Directives:

2006/42/EC	EC Machinery Directive 2006/42/EC
2004/108/EC	(Electromagnetic Compatibility) Directive 2004/108/EC of the European Parliament and the Council dated 15 December 2004 on the harmonisation of legal regulations in the member states regarding electromagnetic compatibility and replacing Directive 89/336/EEC

Source of the applied harmonised standard acc. to Article 7, para. 2:

EN ISO 12100-2:2003-11	Safety of Machinery – Basic concepts; general principles for design – Part 2 Technical principles
EN ISO 14121-1:2007	Safety of Machinery – Risk assessment – Part 1: Principles (ISO14121-1:2007)
EN 50498:2010	Electromagnetic compatibility - Product family standard for electronic equipment installed subsequently in vehicles
EN ISO 14982:2009	Electromagnetic compatibility - Agricultural and forestry machinery

Source of the applied other technical standards and specifications:

EN ISO 12100-1:2003-11	Safety of Machinery – Basic concepts; general principles for design – Part 1: Basic terminology, methodology
------------------------	--

Westerstetten, 01.02.2012

Place, date



Signature
 Helmut Lehner
 CEO

**UK
CA**

Declaration of Conformity

OM version

We, LEHNER Maschinenbau GmbH, D 89198 Westerstetten, GERMANY,
 Tel. +49 7348959622 declare on our sole responsibility that the product:

Description	12-Volt Spreader
Brand	LEHNER
Type / Model	POLARO 70
Identification	Serial numbers dating from 2021 and onwards

complies fully with the following UK regulations:

Description
The Supply of Machinery (Safety) Regulations Electromagnetic Compatibility Regulations

and that the following standards and/or technical specifications are applied

2006/42/EC	EC Machinery Directive 2006/42/EC
2004/108/EC	(Electromagnetic Compatibility) Directive 2004/108/EC of the European Parliament and the Council dated 15 December 2004 on the harmonisation of legal regulations in the member states regarding electromagnetic compatibility and replacing Directive 89/336/EEC
EN ISO 12100-2:2003-11	Safety of Machinery – Basic concepts; general principles for design – Part 2 Technical principles
EN ISO 14121-1:2007	Safety of Machinery – Risk assessment – Part 1: Principles (ISO14121-1:2007)
EN 50498:2010	Electromagnetic compatibility - Product family standard for electronic equipment installed subsequently in vehicles
EN ISO 14982:2009	Electromagnetic compatibility - Agricultural and forestry machinery
EN ISO 12100-1:2003-11	Safety of Machinery – Basic concepts; general principles for design – Part 1: Basic terminology, methodology

Westerstetten, November 2021



 Thomas Renz
 Sales & Marketing Manager

LEHNER Maschinenbau GmbH

Responsible for technical documentation

 UK Importer:
 Husqvarna UK Ltd
 Preston Road, Co. Durham
 DL5 6UP

6.2 Identification

The serial number of the spreader is applied to the rear of the frame.

Note the serial number in this operating manual so that it is readily available for inquiries.

6.3 Distribution box reference list

POLARO Standard LAS

Control cable Junction box

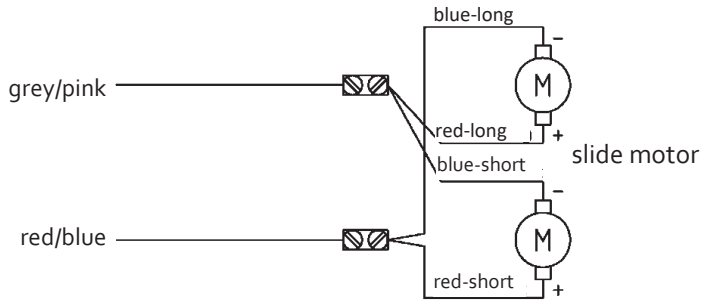
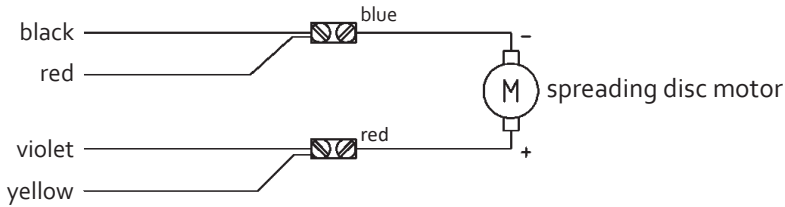
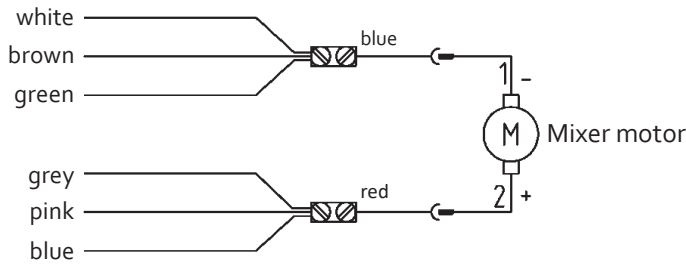

- brown/green ———— [diagonal hatching] free 'not assigned'
- white/yellow ———— [diagonal hatching] free 'not assigned' sensor
- yellow/brown ———— [diagonal hatching] free 'not assigned'

- white/green ———— [diagonal hatching] free 'not assigned'

6.4 Parts list POLARO®

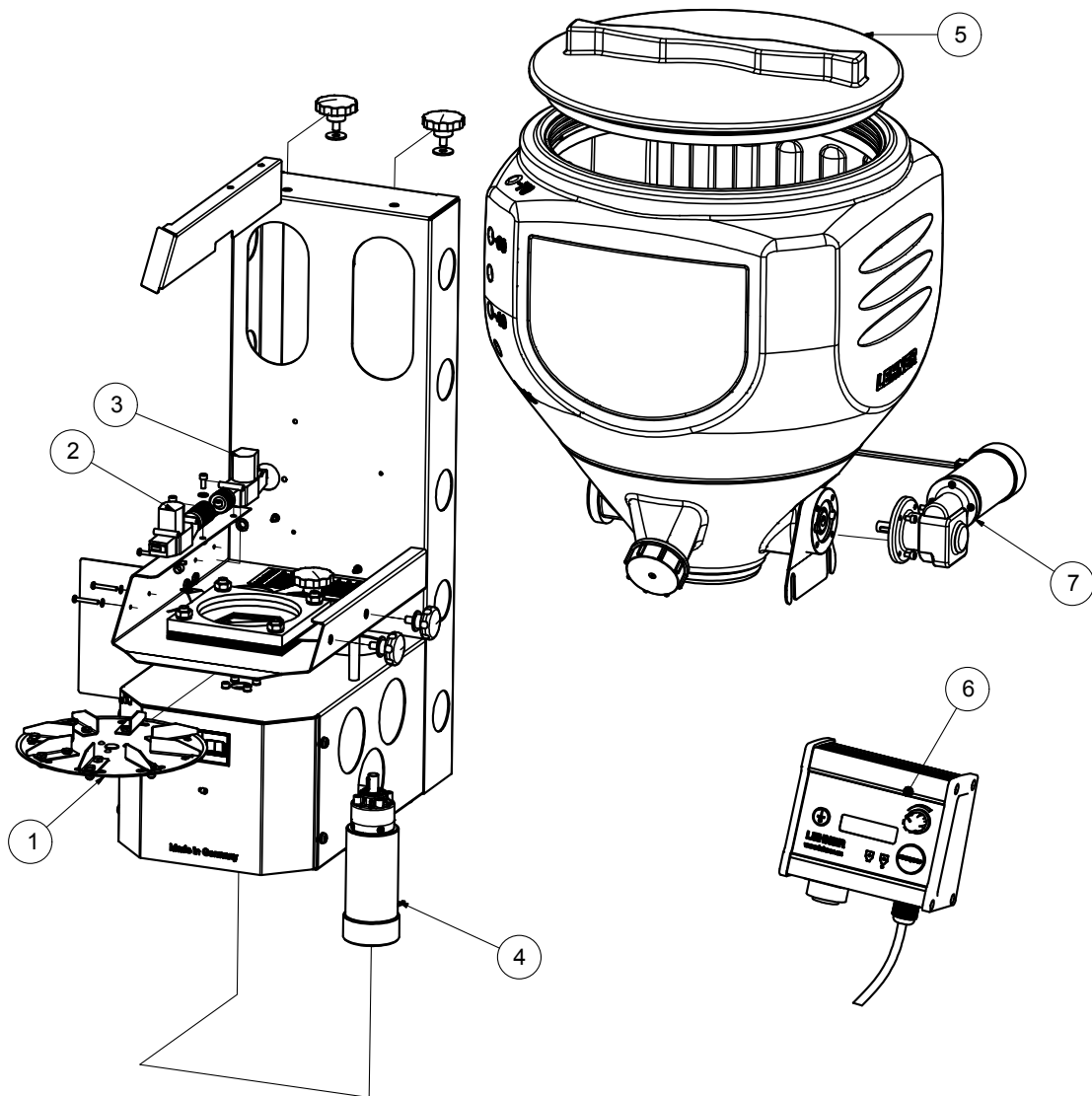

POLARO®			
Object	Designation	Parts number Husqvarna	Parts number LEHNER
1	Spreading disc without magnets	582592602	81361
2	Slide motor, long cable	582592201	80109
3	Slide motor, short cable	582592101	80108
4	Spreading disc motor	582592301	80141
5	Hopper Lid	582591501	80107
6	POLARO® LAS control panel	582592901	81467
7	Agitator motor	582592501	80142
not shown	3.3 m control cable with plug	582593101	82859

7 POLARO® error message list

Error	Cause	Solution
E1 - Supply voltage < 9 V.		Please ensure adequate power supply.
E2 = Agitator blocked	Occurs if the agitator has not freed itself after 10 reversals of starting direction.	Switch off the control panel Empty hopper and check for foreign bodies.
E3 = Disc motor blocked	Occurs if the spreader disc does not start or is blocked.	<ol style="list-style-type: none"> 1. Check the cabling to the motor. 2. Check that spreader disc is free to rotate. 3. If necessary, apply 12 Volt supply direct to spreader disc motor.
E4 = Slider error		Contact the manufacturer
E5 = Agitator fault	Occurs if the agitator is not plugged in or if the cable is broken.	Check cabling to motor and, if necessary, apply 12 V supply direct to motor.

8 Care and maintenance instructions POLARO[®]

LEHNER POLARO[®] **Update 07/2011**

Care and maintenance instructions

Lubricate the drive motor on the agitator **weekly** during the season.
You will find the lubricating nipple for this on the front panel on the left.

At the end of the season, we recommend cleaning and lubricating the drive motor and the agitator motor.

This will help prolong the life of your motors.

Carry out this maintenance work correctly.

Failure to do so will nullify the warranty.

A description of how to care for and maintain the motor can be found in your POLARO[®] operating manual.

If you find it difficult to insert the container into the holder, grease it with a little conventional lubricant.

During the spreading season, lubricate the drive motor and the agitator motor weekly.

9 Spring steel

Load relief roof with and without spring steel

Spring steel

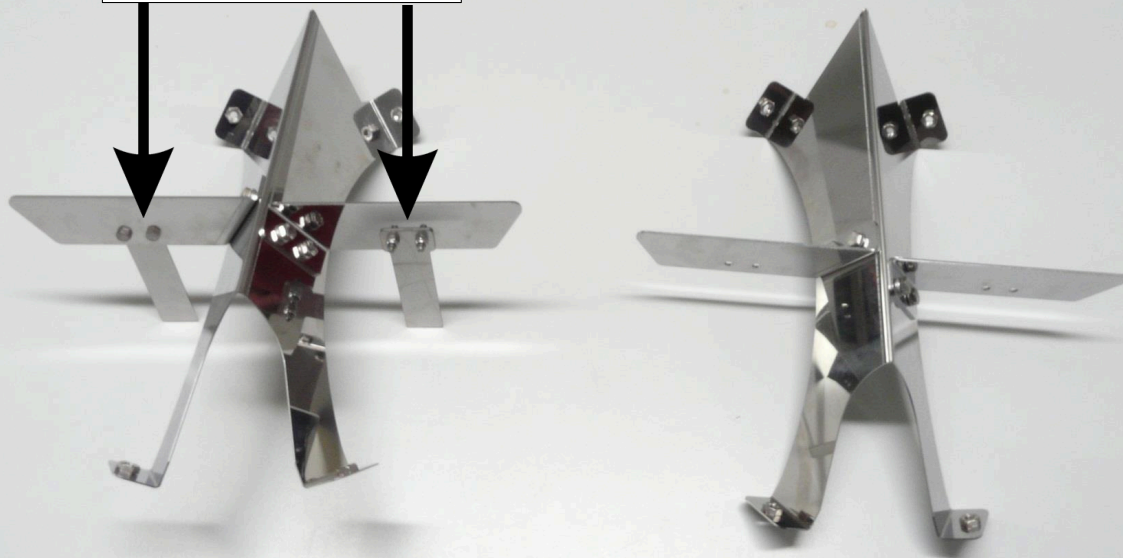

Please install spring steel if required. This may in cases of:
bridging, where there is uneven spreading or poor flow of the spreading material.
Installation can result in increased operating noise.

Agitator with M6 capped nut

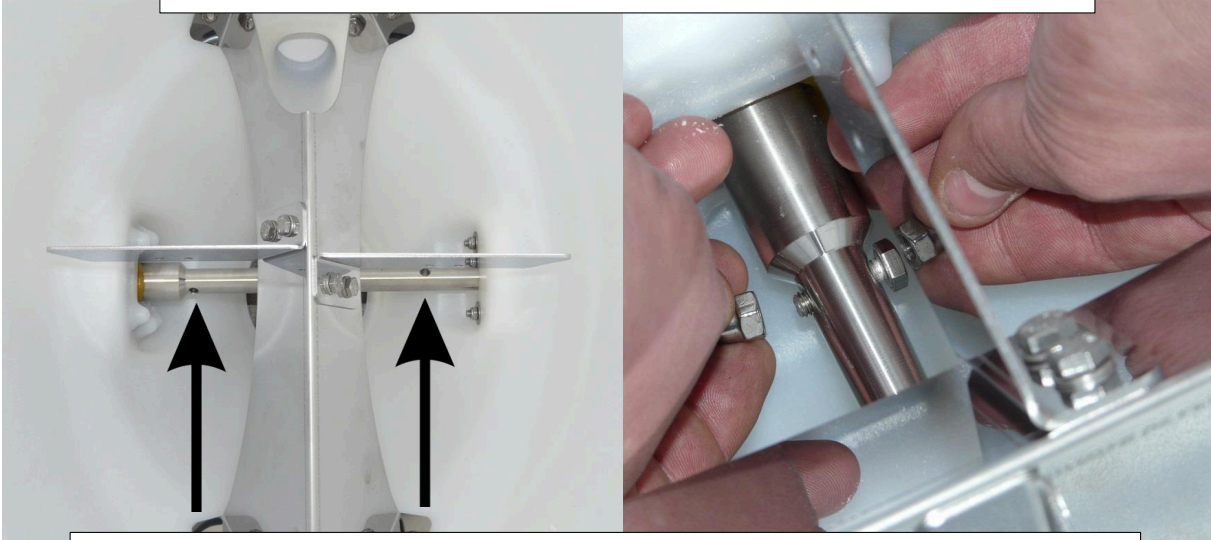

Guide the M6x25 screw through the agitator in the holes marked red and mate with the M6 capped nut.

Please note that the capped nut also has to be glued into place, for example with a Loctite adhesive.

10 Attaching POLARO® to the Husqvarna Rider P 500 series

