



Operator's manual
HUSQVARNA AUTOMOWER®
450X/450XH EPOS



EN, English

Read the operator's manual carefully and make sure that you understand the instructions before you use the product.

Contents

1 Safety		6 Troubleshooting	
1.1 Safety definitions.....	3	6.1 Introduction - troubleshooting.....	26
1.2 General safety instructions.....	3	6.2 Fault messages.....	26
1.3 Safety instructions for installation.....	4	6.3 Information and warning messages.....	32
1.4 Safety instructions for operation.....	4	6.4 LED indicator lamp on the charging station.....	33
1.5 Safety instructions for maintenance.....	4	6.5 LED indicator on the product.....	33
1.6 Battery safety.....	4	6.6 Symptoms.....	34
1.7 To lift and move the product.....	5		
2 Introduction		7 Transportation, storage and disposal	
2.1 Support.....	6	7.1 Transportation.....	36
2.2 System description.....	6	7.2 Storage.....	36
2.3 Product description.....	6	7.3 Disposal.....	36
2.4 System overview.....	7		
2.5 Product overview.....	8	8 Technical data	
2.6 Symbols on the product.....	8	8.1 Technical data.....	37
2.7 Symbols on the battery.....	9	8.2 Registered trademarks.....	39
2.8 Symbols in the Automower® Connect app.....	9		
2.9 General manual instructions.....	10	9 Warranty	
		9.1 Warranty terms.....	40
3 Installation		10 Applicable to US/CA market	
3.1 Introduction - Installation.....	11	10.1 Supplier's Declaration of Conformity.....	41
3.2 Primary components for installation.....	11	10.2 Compliance requirements.....	41
3.3 To prepare for installation.....	11		
3.4 To examine where to put the reference station...	11		
3.5 To examine where to put the charging station...	11		
3.6 To examine where to put the power supply.....	12		
3.7 To examine where to install the objects on the map.....	13		
3.8 Installation of the product.....	13		
3.9 Settings.....	18		
4 Operation			
4.1 Main switch.....	22		
4.2 To start the product.....	22		
4.3 To select operation mode Start.....	22		
4.4 Operating mode - Park.....	22		
4.5 To stop the product.....	23		
4.6 To set the product to OFF.....	23		
4.7 To charge the battery.....	23		
5 Maintenance			
5.1 Introduction - maintenance.....	24		
5.2 Clean the product.....	24		
5.3 Replacement of the blades.....	24		
5.4 Battery.....	25		
5.5 Winter service.....	25		

1 Safety

1.1 Safety definitions

Warnings, cautions and notes are used to point out specially important parts of the manual.



WARNING: Used if there is a risk of injury or death for the operator or bystanders if the instructions in the manual are not obeyed.



CAUTION: Used if there is a risk of damage to the product, other materials or the adjacent area if the instructions in the manual are not obeyed.

Note: Used to give more information that is necessary in a given situation.

1.2 General safety instructions



WARNING: Read the warning instructions that follow before you use the product.

- Read the Operator's manual carefully and make sure you understand the instructions before you use the product. Keep for future reference.
- This appliance is not intended for use by children or persons with reduced physical, sensory or mental capabilities (that could affect a safe handling of the product), or lack of experience and knowledge, unless they have been given supervision or instruction concerning use of the appliance by a person responsible for their safety.
- The product must only be used with the equipment recommended Husqvarna. All other types of use are incorrect.
- Do not use the product when persons, especially children, or animals are in the work area.
- To prevent damage to the product and accidents to vehicles and persons, do not install work areas and transport paths across public pathways.
- Do not use the product in areas where persons are not aware of the product.
- Warning signs must be put around the work area of the product if it operates in public areas. The signs must have the text that follows: Warning! Automatic lawn mower! Keep away from the machine! Supervise children!
- Do not run when you operate the product manually with appDrive. Always walk, be sure on footing on slopes and make sure to have balance at all times. Always wear substantial footwear and long trousers when you operate the product with appDrive.
- Do not touch moving hazardous parts, such as the blade disc, before it has come to a complete stop.
- Set the product to OFF before you clear a blockage, do maintenance or examine the product, and if the product starts to vibrate abnormally. Examine the product for damage before you start the product again. Do not use the product to it is defective.
- If an injury or accident occur get medical aid.
- Do not install the mains cable in an area where the product cuts. Follow the instructions to install the mains cable, refer to *Installation on page 11*. Installation must be done by service personnel.
- Do not connect a damaged cable or plug, or touch a damaged cable, before it is disconnected from the power outlet. Disconnect the plug from the power outlet if the cable becomes damaged while in operation. A worn or damaged cable increases the risk of electrical shock. A damaged cable must be replaced by service personnel.
- When you connect the mains cable to the power outlet, use a residual-current device (RCD) with a tripping current of maximum 30 mA.
- Only charge the product in the included charging station. For safe disposal of the battery, refer to *Disposal on page 36*. Incorrect use may result in electric shock, overheating or leaking of corrosive liquid from the battery. In the event of leakage of electrolyte, flush with water/neutralizing agent. Get medical aid if corrosive liquid comes in your eyes.
- Use only original batteries recommended by Husqvarna. Product safety cannot be guaranteed with other than original batteries. Do not use non-rechargeable batteries.
- Follow the installation instructions that includes to specify the work area and to attach the cutting deck or other attachments, refer to *Installation on page 11*.
- Follow the instructions about to start and operate the product, refer to *Operation on page 22*.
- If there is a risk of thunderstorm, Husqvarna recommends that the mains cable to the charging station and the power supply unit to the reference station are disconnected to decrease the risk of damage to electrical components. Connect the mains cable and the power supply again if there is no longer a risk of thunderstorm.
- Follow the maintenance instructions and if necessary use Husqvarna original spare parts, refer to *Maintenance on page 24*.

- For technical data such as weight, dimensions and noise emission values, refer to *To prepare for installation on page 11*.
- The operator is responsible for accidents or dangers that occurs to other persons or property.
- The product must only be operated, maintained and repaired by persons that are fully conversant with its special characteristics and safety regulations.
- It is not permitted to change the initial design of the product.
- Obey national regulations about electrical safety.
- Husqvarna does not guarantee full compatibility between the product and other types of wireless systems such as remote controls, radio transmitters or equivalent.
- The built-in alarm is very loud. Be careful, especially if the product is handled indoors.
- Operation and storage temperature is 0-50 °C / 32-122 °F. Temperature range for charging is 0-45 °C / 32-113 °F. Too high temperatures might cause damage to the product.

1.3 Safety instructions for installation



WARNING: Read the warning instructions that follow before you use the product.

- Do not install the charging station in an area where there is a risk that persons trip on it.
- Do not install the charging station, including any accessory, at a location that is below, or within 60 cm / 24 in. from, any combustible material. In case of malfunction, heating of the charging station and the power supply may occur and create a potential risk of fire.
- Applicable to USA/Canada. If power supply is installed outdoors: Risk of Electric Shock. Install only to a covered Class A GFCI receptacle (RCD) that has an enclosure that is weatherproof with the attachment plug cap inserted or removed.

1.4 Safety instructions for operation



WARNING: Read the warning instructions that follow before you use the product.

- Keep your hands and feet away from the rotating blades. Do not put your hands or feet near or below the product when it is set to ON.
- Use the park mode or set the product to OFF when persons, especially children or animals are in the work area. Refer to *To set the product to OFF on page 23*. Husqvarna recommends to set the

product to operate when the work area has no activity. The product can cause injury to animals at night in work area, for example hedgehogs. Refer to *Operating mode - Park on page 22*.

- Make sure that there are no objects such as stones, branches, tools or toys on the lawn. The blades can be damaged if it hits an object.
- Do not lift the product or move it when it is set to ON.
- Do not to let the product collide with persons or animals. If a person or animal comes in the way of the product, stop the product immediately. Refer to *To stop the product on page 23*.
- Do not put objects on top of the product, the charging station or the reference station.
- Do not use the product if the **STOP** button does not work.
- Always set the product to OFF when it is not in operation. The product can only start when you enter the correct PIN code.
- Do not use the product at the same time as a pop-up sprinkler. Use the *Schedule* function so the product and pop-up sprinkler do not operate at the same time. Refer to *Schedule on page 18*.

1.5 Safety instructions for maintenance



WARNING: Read the warning instructions that follow before you do maintenance on the product.

- Set the product to **OFF** when you do maintenance on the product.
- Do not use a high-pressure washer or running water to clean the product. Do not use solvents to clean the product.
- Disconnect the plug to the charging station before you clean or do maintenance of the charging station.

1.6 Battery safety



WARNING: Read the warning instructions that follow before you use the product.

- Lithium-ion batteries can explode or cause fire if disassembled, short-circuited, exposed to water, fire, or high temperatures. Handle carefully, do not dismantle, open the battery or use any type of electrical/mechanical abuse. Avoid storage in direct sunlight.

1.7 To lift and move the product

To safely move the product from or in the work area the product can be lifted or operated with appDrive. Refer to *appDrive on page 22*.



WARNING: The product must be set to OFF before you lift the product. The product is disabled when the **Main switch** is set to the 0 position.



CAUTION: Do not lift the product when it is parked in the charging station. It can cause damage to the charging station and/or the product. Push the **STOP** button and pull the product out of the charging station before you lift it.

1. Push the **STOP** button to stop the product.

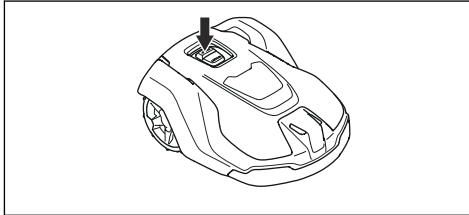

2. Set the **Main switch** to the 0 position.

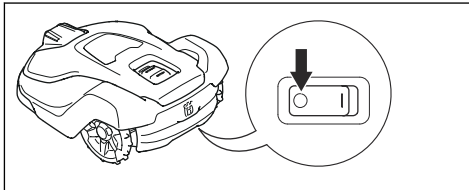

3. Lift the product by the handle with the blade disc away from your body.



2 Introduction

Serial number:
Product number:
PIN code:

The serial number and the product number are on the product rating plate and on the product carton.

- Register your product on www.husqvarna.com. Enter the serial number of the product, the product number and the date of purchase to register your product.

2.1 Support

For support about the product, speak to your Husqvarna servicing dealer.

2.2 System description

The system contains a robotic lawn mower, a charging station and a reference station. The robotic lawn mower and reference station uses the technology with satellite signals to position the robotic lawn mower correctly, this means that boundary wires are not necessary. The reference station is stationary and sends correction data to the robotic lawn mower to get an accurate position of the robotic lawn mower. The virtual work area for the product is made in the Automower® Connect app. The product is operated and waypoints are added to make a map in the app. Refer to *System overview on page 7*.

2.3 Product description

Note: Husqvarna regularly updates the appearance and function of the products. Refer to *Support on page 6*.

The product is a robotic lawn mower. The product has a battery power source and cuts grass automatically. It continuously alternates between mowing and charging. The movement pattern of the product can be set to random or systematic. The virtual boundary specifies the work area where the product is allowed to operate. The satellite receiver in the product senses when it is approaching the virtual boundary. When the product hits an obstacle or approaches the virtual boundary the product selects a new direction.

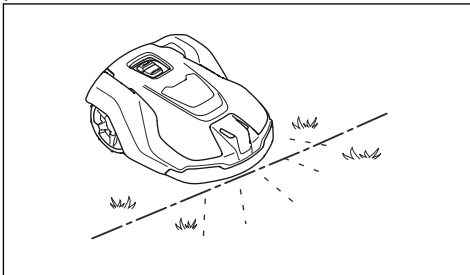

The operator selects the operation settings in the Automower® Connect app. The app shows the selected and possible operation settings, and the operation mode of the product.

2.3.1 Mowing technique

The frequent cutting technique improves the grass quality and decreases the use of fertilizers. Collection of grass is not necessary.

2.3.2 Find the charging station

The product operates until the battery state of charge is low or until the work area is cut, then the product starts to go to the charging station. The product uses EPOS guidance with satellite signals to find a path to the charging station. This decreases the wear on the lawn and the time to find the charging station.

2.3.3 Connectivity

Automower® Connect is an app that you can use to install the product and to select the operation settings of the product. Refer to *Automower® Connect on page 14*.

2.4 System overview

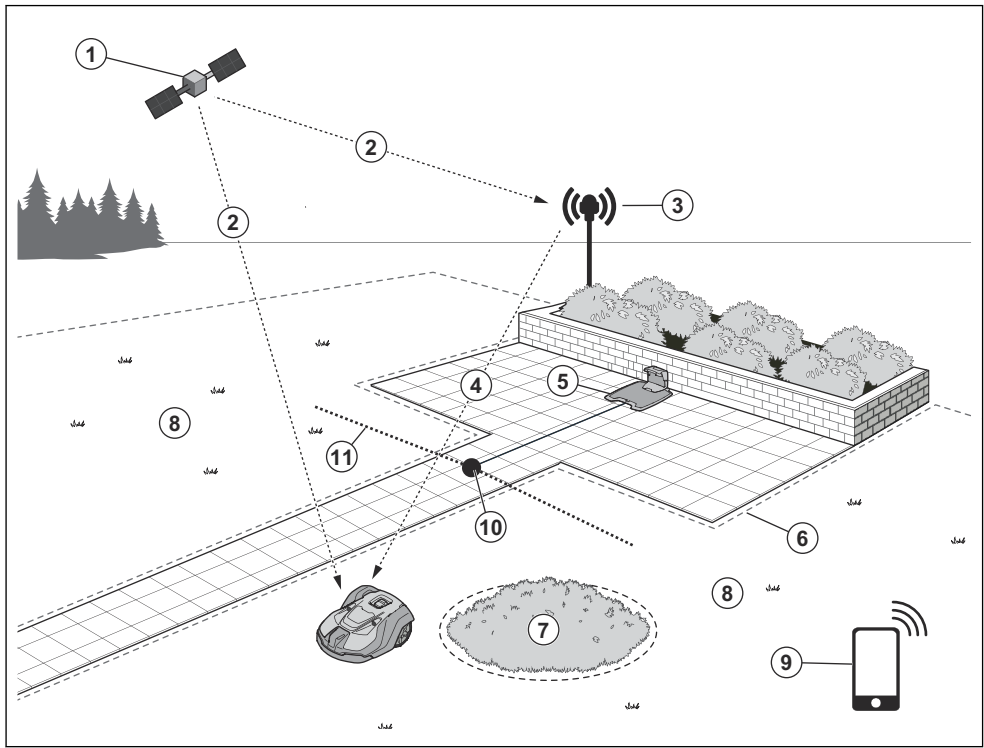

- | | |
|-----------------------------------|-------------------------------|
| 1. Satellites | 7. Stay-out zone |
| 2. Satellite signals | 8. Work area |
| 3. Reference station ¹ | 9. Mobile device ² |
| 4. Correction data | 10. Docking point |
| 5. Charging station | 11. Transport path |
| 6. Virtual boundary | |

¹ Not included.

² Not included.

2.5 Product overview

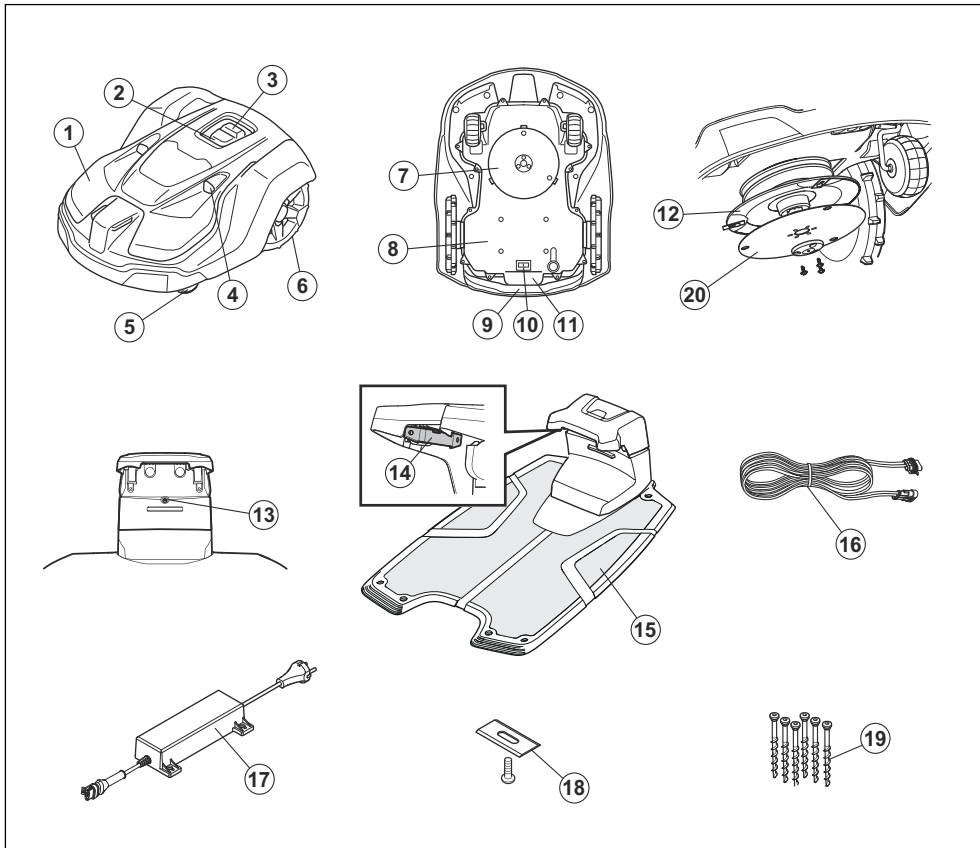

- | | |
|---|---|
| <ol style="list-style-type: none"> 1. Body 2. LED indicator lamp of the product 3. STOP/START button 4. Ultrasonic sensors 5. Front wheels 6. Rear wheels 7. Cutting system 8. Chassis box with electronics, battery and motors 9. Handle 10. Main switch 11. Rating plate (including product identification code) 12. Blade disc 13. LED indicator lamp of the charging station 14. Contact strips 15. Charging station | <ol style="list-style-type: none"> 16. Low-voltage cable 17. Power supply³ 18. Extra blades 19. Screws for securing the charging station |
|---|---|

2.6 Symbols on the product

These symbols can be found on the product. Study them carefully.

³ The appearance may differ depending on market.



WARNING: Read the user instructions before operating the product.



WARNING: Disable the product before working on or lifting the product.



WARNING: Keep a safe distance from the product when operating. Keep your hands and feet away from the rotating blades.



WARNING: Do not ride on the product. Do not put your hands or feet close to or under the product.

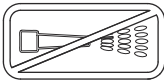

Do not use a high-pressure washer or even running water to clean the product.

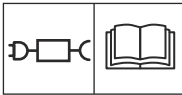

Use a detachable power supply as defined on the rating label next to the symbol.



This product complies with the applicable EU Directives.



This product complies with the applicable UK Directives.



It is not permitted to dispose this product as normal household waste. Ensure that the product is recycled in accordance with local legal requirements.



The chassis contains components which are sensitive to electrostatic discharge (ESD). The chassis must also be resealed in a professional manner. For these reasons the chassis shall only be opened by authorized service technicians. A broken seal can result in the entire or parts of the guarantee no longer being valid.



The low-voltage cable must not be shortened, extended or spliced.

Do not use a trimmer nearby the low-voltage cable. Be careful when trimming edges where the cables are placed.

2.7 Symbols on the battery



WARNING: Lithium-ion batteries can explode or cause fire if disassembled, short-circuited or handled roughly. Do not expose to water, fire or high temperature.



Read the user instructions.



Do not discard the battery into fire and do not expose the battery to a heat source.



Do not immerse the battery into water.

2.8 Symbols in the Automower® Connect app



Shows the strength of the radio signal that the product receives from the reference station.

The status is EPOS confirmed. The product has an accurate position and direction. This is necessary to operate the product automatically and for the installation of map objects.



The status is EPOS action is necessary. The product has an accurate position but it is necessary to operate the product, manually or automatically, to get an accurate direction.



The status is EPOS searching. The product does not have an accurate position and is searching for the satellite signals and the correction data to get an accurate position.



2.9 General manual instructions

The following system is used in the Operator's Manual to make it easier to use:

- Text written in *italics* is a text that is in the Automower® Connect app, or is a reference to another section in the Operator's manual.
- Text written in **bold** is one of the buttons on the product or in appDrive.

3 Installation

3.1 Introduction - Installation



WARNING: Read and understand the safety chapter before you install the product.



CAUTION: Use original spare parts and installation material.

Note: Refer to www.husqvarna.com for more information about installation.

3.2 Primary components for installation

The installation includes the components that follow:

- Robotic lawn mower, that cuts the lawn automatically.
- Charging station, that charges the product.
- Power supply, which is connected to the charging station and a 100-240V power outlet.
- Reference station⁴, that receives satellite signals and sends correction data to the robotic lawn mower.
- Mobile device with the Automower® Connect app to do the installation and the settings for the product.

3.3 To prepare for installation



CAUTION: Holes with water in the lawn can cause damage to the product.



CAUTION: Read the installation chapter before you start the installation.

- Make a blueprint of the work area and include all obstacles. This makes it easier to examine where to put the charging station, the reference station, and the virtual boundaries.
- Make a mark on the blueprint where to put the charging station, the reference station, the maintenance point, the transport paths and the virtual boundaries for the work areas and stay-out zones.
- Make sure that the work area where the product operates has unimpeded sky view.
- Fill in holes in the lawn to make it level.

⁴ Purchased separately.

- Cut the grass before you install the product. Make sure that the grass is maximum 10 cm / 4 in.
-

Note: The first weeks after installation the sound level when the product cuts the grass can be higher than usual. The sound level decreases after some time.

3.4 To examine where to put the reference station

Read and understand the instructions about where to put the reference station. Refer to the Operator's manual for the reference station.

3.5 To examine where to put the charging station

- Put the charging station in an area that you select. Install a transport path if the charging station is not in the work area. It is not necessary to install a transport path if the product is fully in the work area when it is at the charging station docking point.
- You can put the charging station in an Automower® house.
- Keep a minimum 5 m / 16 ft. of free space in front of the charging station.
- Put the charging station (A) where the docking point (B) has unimpeded sky view. This means that 110° of the sky in all directions must be unimpeded. The product cannot receive satellite signals that is less than 10% elevation angle. The charging station docking point (B) is where the product stops after reversing from the charging station. The reversing distance can be set to 70-250 cm / 28-98 in.

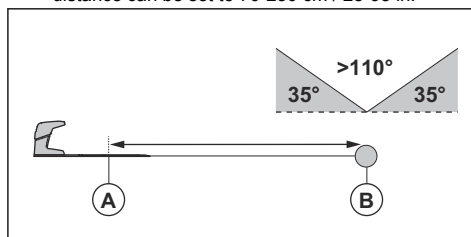

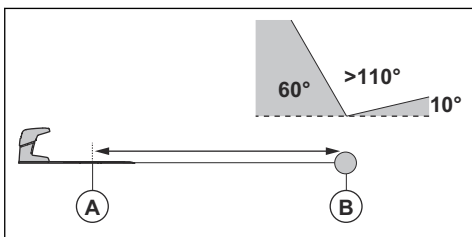

- If the product must not operate in a part of the docking area, put a protective wall that is minimum 15 cm / 6 in. in height. The docking area (A) is a circular area around the charging station with a radius of 3 m / 9.8 ft.

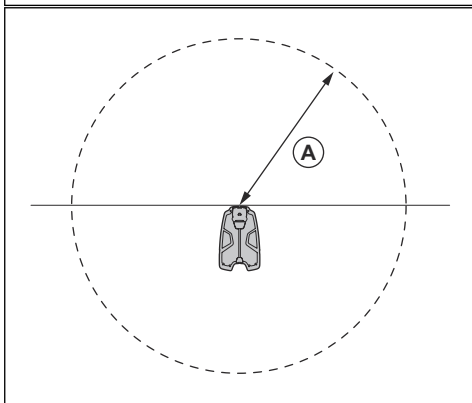
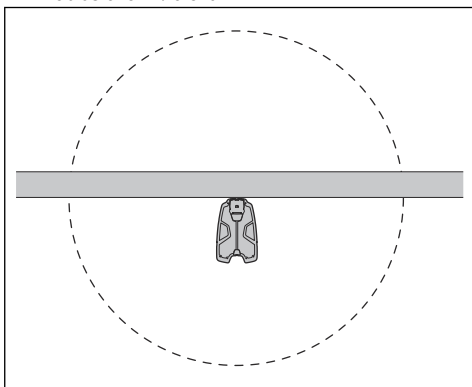

Note: The product uses the charging station signal to search for the charging station when it is in the docking area.

- Put the charging station near a power outlet.
- Put the charging station on a level surface.
- The baseplate of the charging station must not be bent.

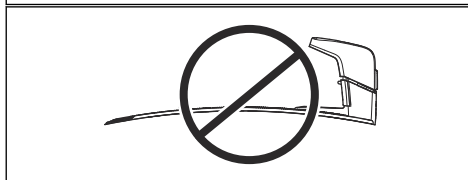
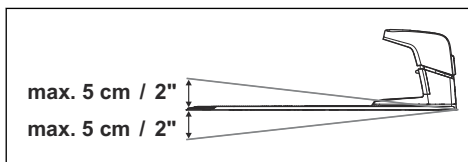

- If the work area has 2 parts separated with a steep slope, Husqvarna recommends to put the charging station in the lower section.



CAUTION: Do not install the charging station where there are metal objects in the ground. Metal objects can cause interference with the charging station signal.

3.6 To examine where to put the power supply



CAUTION: Make sure that the blades on the product do not cut the low-voltage cable.



CAUTION: Do not put the low-voltage cable in a coil or below the charging station plate. The coil causes interference with the signal from the charging station.



- Put the power supply in an area with a roof and protection from the sun and rain.
- Put the power supply in an area with good airflow.
- Use a residual-current device (RCD) with a tripping current of maximum 30 mA when you connect the power supply to the power outlet.

Low-voltage cables of different lengths are available as accessories.

3.7 To examine where to install the objects on the map



CAUTION: If the work area is adjacent to water bodies, slopes, precipices or a public road, the virtual boundary must have a protective wall. The wall must be minimum 15 cm / 6 in. in height.



CAUTION: Do not let the product operate on gravel.



CAUTION: For careful operation without noise, isolate all obstacles such as trees, roots and stones.

Note: Make a blueprint of the work area before you install the virtual boundaries.

- Make sure that the area where the product operates has unimpeded sky view. This means that 110° of the sky in all directions must be unimpeded. The product cannot receive satellite signals that is less than 10% elevation angle.

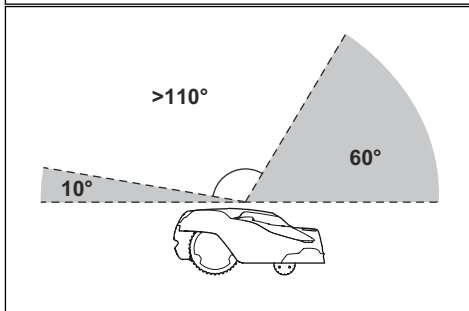
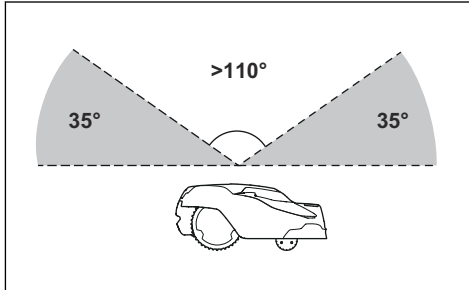

- Make sure that there are no trees near the virtual boundaries and along the paths.

- Make sure that there are no trees with thick vegetation in the areas where the product operates.
- Make sure that the product can receive radio signals from the reference station in all parts of the work area. The maximum distance between the reference station and the product is 500 m / 1640 ft. The maximum distance decreases if there is objects between the reference station and product.

3.7.1 Passages

A passage is a section that has virtual boundary on each side and that connects 2 parts of the work area. The passage must be a minimum of 2 m / 6.5 ft. wide to get a good cutting result. Short passages can be as narrow as 1 m / 3.3 ft. A long narrow passage can have a negative impact of the cutting result. A dead end must be a minimum of 2 m / 6.5 ft. wide.

3.7.2 To install the map objects in a slope

The product can operate in 45% slopes. Do not include too steep slopes in the work area. Too steep slopes can be isolated as stay-out zones. The slope (%) is calculated as height for each m. Example: 10 cm / 100 cm = 10%.

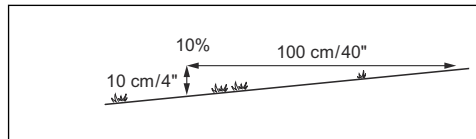

- For slopes more than 45% in the work area, isolate the slope with a stay-out zone.
- For slopes that are more than 15% along the outer edge of the lawn. For installation of the virtual boundary, operate the product with the rear wheel 5 cm / 2 in. (A) from the edge.

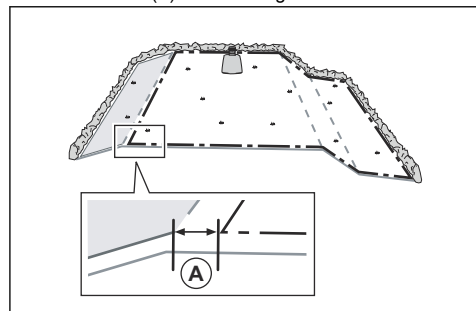

- For slopes adjacent to a public road, put a fence or a protective wall along the outer edge of the slope.

3.8 Installation of the product

3.8.1 To install the product

Do the general steps that follow to install the product:

1. Install the reference station. Refer to the Operator's manual for the reference station.
2. Install the charging station. Refer to *To install the charging station on page 14*.
3. Install the Automower® Connect app on your mobile device. Refer to *To install the Automower® Connect app on page 15*.
4. Do a pairing operation of the product and the Automower® Connect app. Do the basic settings in the start up sequence in the Automower® Connect app. Refer to *To install the Automower® Connect app on page 15*.
5. Make a map with work areas, stay-out zones, transport paths and maintenance points. Refer to *To install objects on the map on page 16*.
6. Use Automower® Connect app to do settings for the product. Refer to *Settings on page 18*.

3.8.2 Installation tools

- Hex key, 8 mm. Included in the carton.

3.8.3 Installation of the charging station

Read and understand the instructions about the charging station. Refer to *To examine where to put the charging station on page 11*.



CAUTION: Do not make new holes in the charging station plate.



CAUTION: Do not put your feet on the baseplate of the charging station.



WARNING: Make sure that the plugs of the low-voltage cable and the power supply unit are clean and dry before you connect them.

When you connect the power supply, only use a power outlet that is connected to a residual-current device (RCD).

3.8.3.1 To install the charging station

1. Put the charging station in the selected area.
2. Attach the charging station to the ground with the supplied screws.
3. Connect the low-voltage cable to the charging station.
4. Put the power supply at a minimum height of 30 cm / 12 in. Refer to *To examine where to put the power supply on page 12*.

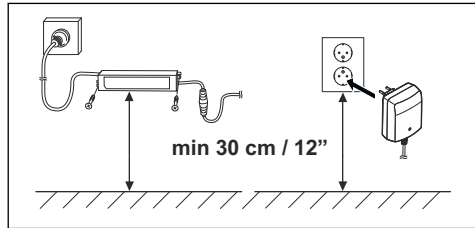

5. Connect the power supply cable to a 100-240V power outlet.
6. Put the low-voltage cable in the ground outside the work area. Use stakes or bury the cable.
7. Put the product in the charging station to charge the product.

3.8.3.2 To do a visual check of the charging station

1. Make sure that the indicator LED lamp on the charging station has a green light.

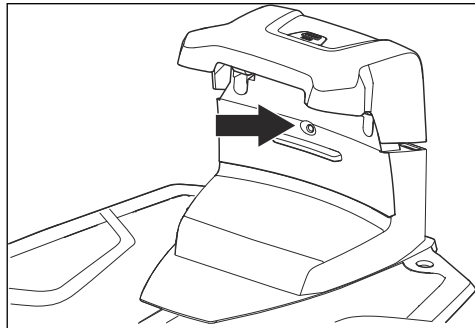

2. If the indicator LED lamp does not have a green light, do a check of the installation. Refer to *To install the charging station on page 14* and *LED indicator lamp on the charging station on page 33*.

3.8.4 Installation of the reference station

Install the reference station according to the instructions in the Operator's manual for the reference station.

3.8.5 Automower® Connect

Automower® Connect is a free app for your mobile device. Use the app for installation, settings and operation of your product. You can also find more information for example about alarm and statistics in the Automower® Connect app.

The app gives 2 modes of connectivity: Long-range cellular connectivity and Short-range Bluetooth® connectivity.

- Dashboard that shows the current status of the product and the battery state of charge.
- Account shows an overview of the account settings and the unit format can be set.

- My mowers can manage all the products paired to your account and add new ones.

Note: All countries do not support cellular connection to Automower® Connect because of regional specified cellular systems. The included Automower® Connect lifetime service only applies if there is a third part sub-supplier of 2G/4G available in the operational area.

3.8.5.1 To install the Automower® Connect app

1. Download the Automower® Connect app on your mobile device.
2. Sign up for a Husqvarna account in the Automower® Connect app.
3. An e-mail is sent to the registered e-mail address. Follow the instructions in the e-mail in less than 24 hours to validate your account.
4. Log in to your Husqvarna account in the Automower® Connect app.

3.8.5.2 Automower® Direct

You can use Automower® Direct if you have the Automower® Connect app and the PIN code for the product but no Husqvarna account.

Automower® Direct uses short-range Bluetooth® connectivity. It can be used if the cellular connectivity is not supported or for a temporary connection to the product.

3.8.6 To do the basic settings

When the product is set to ON for the first time, there are some basic settings to do before the product can start to operate. You must do a pairing operation of the product and the Automower® Connect app to install objects on the map, change the settings and operate the product. Use the Automower® Connect app on your mobile device.

1. Set the product to ON.

Note: The Bluetooth® pairing operation mode of the product is enabled for 3 minutes. If the pairing operation between the product and the mobile device is not completed in 3 minutes, set the product to OFF and then set the product to ON.

2. Log on to your Husqvarna account in the Automower® Connect app.
3. Start Bluetooth® on your mobile device.
4. Select *My mowers* in the Automower® Connect app and add your product.
5. Enter the factory PIN code.
6. Do a pairing operation of the product and the charging station.
7. Do a pairing operation of the product and the reference station.

8. Set the docking point.
9. If GeoFence is to be used, select to enable the function.

Note: It is only necessary to do a pairing operation of the Automower® Connect app and the product one time.

3.8.7 Installation of the map objects

Read and understand the instructions about where to install the map objects. Refer to *To examine where to install the objects on the map on page 13*.

On the map you can install the objects that follow in the Automower® Connect app:

- *Work areas* (A)
- *Stay-out zones* (B)
- *Transport path* (C)
- *Charging station* (D)
- *Maintenance point* (E)
- *Reference station* (F)
- *Work area, Secondary area* (G)

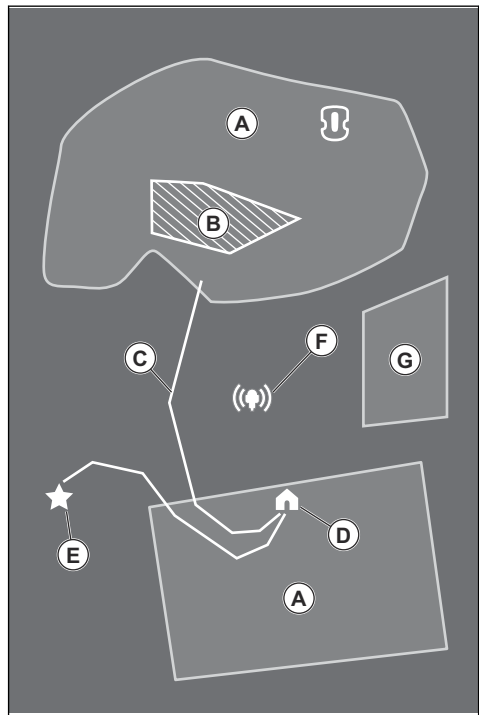

For a complete map installation, you must install a work area and a charging station on the map.

A work area is specified by virtual boundaries. Maximum 20 work areas and secondary areas can be installed on a map.

There are two types of work areas:

- A work area that has a charging station in it or connected to it with a transport path where the product operates automatically.
- A secondary area is a work area with no charging station and no transport path. The product must be moved manually to and from the work area.

A transport path is a specified path between the docking point in front of the charging station and a work area.

The product can operate automatically in this path, but does not cut grass. A transport path can temporarily be enabled and disabled in the app.

Stay-out zones can be made if there are areas where the product must not operate. A stay-out zone is specified by virtual boundaries. Stay-out zones can temporarily be enabled and disabled in the app.

A maintenance point is a specified position where the product can be parked at. This can for example be used for a service point where maintenance of the product is done. The maintenance point is connected to the docking point with a path.

To install objects on the map, operate the product with the appDrive installation to add waypoints on the map. Refer to *To install objects on the map on page 16*.

3.8.7.1 To install objects on the map

The waypoints (A) are positions that makes the virtual boundaries and paths (B). The lines are straight between the waypoints. Add a number of waypoints to make smooth curves. You can adjust the positions of the waypoints in the app after the installation of the map.

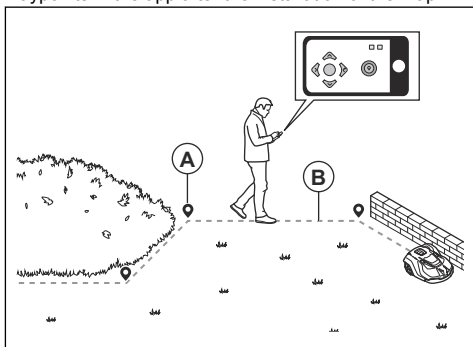

CAUTION: Do not lift and move the product between the waypoints when you install the map objects. Use appDrive for a correct installation.

Note: The position of the waypoint when you install a work area or a stay-out zone is in the front left corner of the product.

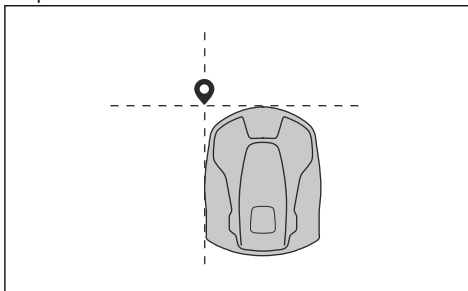

Note: The position of the waypoint when you install a transport path or a path to a maintenance point is in the middle of the product between the drive wheels.



- Make sure that you are near the product and connected to the product with the app with Bluetooth®.
- Make sure that the status is *EPOS confirmed* in the appDrive.
- Select the object you want to install and use the buttons in the appDrive installation to operate the product.
- Use the **up** button (A) to move the product forward.
- Use the **down** button (B) to move the product rearward.
- Use the left **arrow** button (C) to rotate the product to the left.
- Use the right **arrow** button (D) to rotate the product to the right.
- Use the **center** button (E) as a joystick to move and rotate the product in any direction.
- Use the **waypoint** button (F) to add a waypoint in the map.

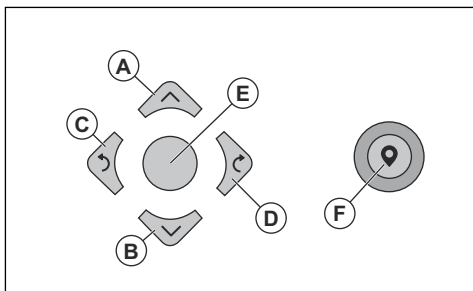

Note: Walk 2-3 m / 6.5-9.8 ft. behind the product when you operate the product with appDrive.

To make a work area

Minimum 3 waypoints are necessary to make a work area.

- Operate the product clockwise around the boundary of the work area.
- Add waypoints on the map. Add the waypoints minimum 3 cm / 1 in. from obstacles.

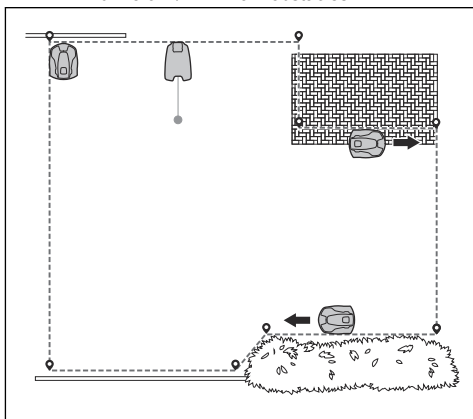

- Add a waypoint to make the product cut the grass at the edge between the lawn and the stone path. Make sure that you straddle the edge of the lawn and the stone path when you add a waypoint. The product can straddle the edge if the height of the stone path is maximum 1 cm / 0.4 in. in relation to the lawn.

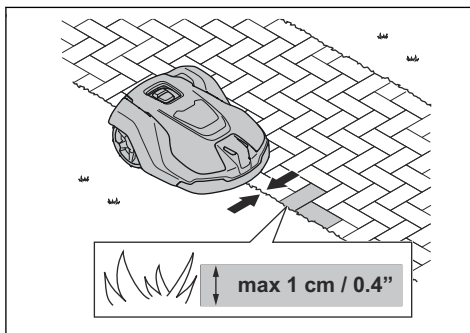

- Add the waypoint at the outer corner to install the virtual boundary around a corner.

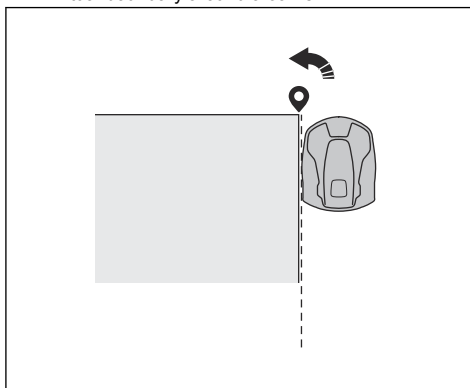

- Do not set waypoints that make a virtual boundary go across itself in the same work area.
- Save the work area to automatically connect the first and last waypoint with a virtual boundary.

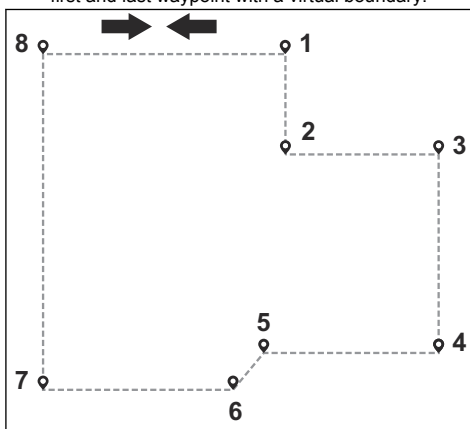

To make a stay-out zone

Minimum 3 waypoints are necessary to make a stay-out zone.

- Operate the product counterclockwise around the boundary of the stay-out zone.
- Add waypoints on the map. Add the waypoints minimum 3 cm / 1 in. from obstacles.
- Do not set waypoints that make a virtual boundary go across itself in the same stay-out zone.
- Save the work area to automatically connect the first and last waypoint with a virtual boundary.

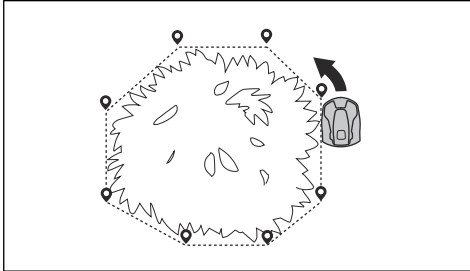

To make a transport path

- Operate the product and add waypoints on the map to install a transport path. Start in a work area minimum 1 m / 3.3 ft. from the virtual boundary.
- Do not install a transport path across a stay-out zone.
- Do not set waypoints that make the transport path go across the same transport path.
- Operate the product and add waypoints to connect the transport path to the docking point.
- Save the transport path to automatically connect the last waypoint to the docking point.
- Set the corridor width (A) for the transport path. The corridor width can be set to 2-5 m / 6.6-16.4 ft.

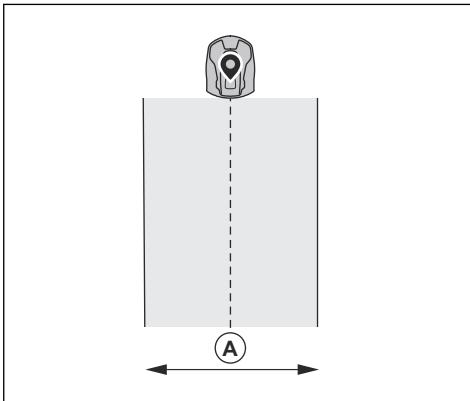

To make a maintenance point

- Operate the product and add waypoints on the map. Start to add waypoints at the position where you install the maintenance point. The first waypoint specifies the maintenance point.

- Operate the product and add waypoints to make a path to the charging station.
- Save the maintenance point to automatically connect the last waypoint to the docking point.
- Set the corridor width (A) for the maintenance point. The corridor width can be set to 2-5 m / 6.6-16.4 ft.

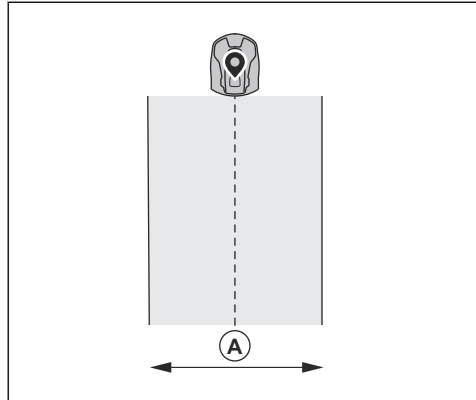

3.9 Settings

The product has factory settings but the settings can be adapted to each work area.

3.9.1 Schedule



In *Schedule* menu you can change the schedule settings for the product. The *Schedule* is set for each work area that is connected to the charging station. *Secondary areas* cannot be scheduled.

The schedule function controls which hours the product is permitted to operate. When the product does not operate it is parked in the charging station. You can see which hours and days the product operates in the schedule overview in the app.

The factory schedule setting lets the product to operate around the clock 7 days a week.

To calculate the schedule setting, refer to *To calculate the schedule setting on page 18*.

3.9.1.1 To calculate the schedule setting

1. Calculate the dimension of your lawn in m^2 / ft^2 .
2. Divide the m^2 / ft^2 of the lawn with the approximate operation capacity. Refer to table below.
3. The result is equal to the number of hours that the product must operate each day.

Note: The operation capacity is approximate and is calculated for flat and open work area. If the work area has a lot of slopes or obstacles, you need to increase the *Schedule* settings.

Model	Approximate operation capacity, m ² /h / ft ² /h
Automower® 450X/450XH EPOS	208 / 2240

Example: A lawn of 3000 m² / 32000 ft², cut with an Automower® 450X/450XH EPOS.

3000 m² / 208 ≈ 14.5 h.

32000 ft² / 2240 ≈ 14.5 h.

Days / week	h / day	Schedule settings
7	14.5	7:00 - 21:30 / 7:00 am - 9:30 pm

3.9.2 Cutting height



The cutting height is set individually for each work area. The cutting height can be set to 20-60 mm / 0.8-2.4 in.

3.9.3 Pattern



The settings for the systematic cutting is set for each work area. You can do these settings:

- Set the pattern for how the product operates.
- Set the direction of the pattern.
- Enable or disable the *Border mowing* where the product cuts around the work area 2-3 times along the virtual boundary.
- Set the type of the *Border mowing*. With *Fixed border mowing* the product always operates in the same paths to keep a sharp border around the work area. With *Variable border mowing*, the product operates in different paths to decrease the risk of track marks along the virtual boundary.

3.9.4 Operation



In the Operation's menu it is possible to change the settings of the *Weather timer*, *ECO mode* and *Spiral cutting*.

3.9.4.1 Spiral cutting

If the product enters an area where it senses the grass is longer than average, it can change the movement pattern to *Spiral cutting*. This means that the product mows in a spiral pattern to faster cut the area with longer grass. It is possible to set the intensity of the *Spiral cutting*. *Very low / Low* intensity means that *Spiral cutting* begins less often. *High / Very high* intensity means that *Spiral cutting* begins more often.

Note: *Spiral Cutting* does not start in slopes steeper than 15%.

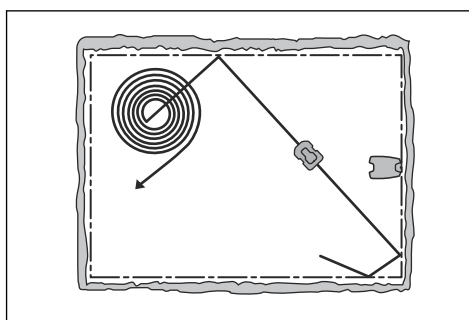

3.9.4.2 Weather timer

Weather timer automatically adjust the cutting time to the growth of the grass. The product is not permitted to operate more than the schedule settings.

Note: When using *Weather timer*, it is recommended to make as much operating time as possible available for *Weather timer*. Do not restrict the schedule more than necessary.

The first operation of the day is set by the schedule settings. The product always complete 1 mowing cycle, and then *Weather timer* selects if the product will continue to operate or not.

Note: *Weather timer* is reset if the product does not operate for more than 50 hours, or if a *Reset of all user settings* is done. *Weather timer* is not changed if a *Reset of schedule settings* is done.

3.9.4.3 ECO mode

If *ECO mode* is enabled, it switches off the signal in the charging station, when the product is parked or is charging.

Note: Use *ECO mode* to save energy and prevent interference with other equipment, for example hearing loops or garage doors.

Note: To start the product manually in the work area, push the **STOP** button before you remove the product from the charging station. If not, the product cannot park at the charging station.

3.9.5 Accessories



Settings for accessories mounted on the product can be made in this menu.

3.9.5.1 Headlights

There are 4 different headlight settings that control when the headlights are on:

- *Always on*
- *Evening only (19:00-00:00)*
- *Evening and night (19:00-07:00)*
- *Always off*

The headlights flashes if there is an error.

Note: Husqvarna recommends to use the headlights at night time.

3.9.5.2 To avoid collisions with the Automower® house

When this option is enabled, the wear on the product and the Automower® house is reduced, but it can result in more uncut grass around the charging station.

3.9.6 General (Bluetooth® only)



This function is used to set time and date, or to reset to default settings.

3.9.6.1 Time & date

The time and date can be changed manually, or by using the time and date from the mobile device.

3.9.6.2 Reset to factory settings

The user settings can be reset to factory settings. All map objects and the schedules will be deleted.

Note: *PIN code, Loop signal, Messages and Date & Time* will not be reset.

3.9.7 Security (Bluetooth® only)



The security settings controls the PIN code, the GeoFence and other security functions. The correct PIN-code must be entered to get access to the *Security* menu in the Automower® Connect app.

3.9.7.1 New loop signal

The loop signal is randomly selected to create a unique link between the product and the charging station. In rare cases, there may be a need to generate a new signal, for instance if 2 adjacent installations have a very similar signal.

3.9.7.2 Change PIN code

You can change the PIN code in the Automower® Connect app. Make a note of the new PIN code in Memo. Refer to *Introduction on page 6*.

3.9.7.3 Theft protection

In the *Theft protection* menu it is possible to set the alarm duration and also what events should trigger the alarm. The factory setting is to require PIN code and the alarm duration is 1 min.

Require PIN code

This function means that the product cannot be operated or controlled after the **STOP** button has been pushed without first entering the correct PIN code. If the incorrect PIN code is entered 5 times, the product is locked for a time. The lock is extended for each new incorrect try.

Alarm duration

There is a possibility to set how long the alarm signal should last. A setting between 1 and 10 minutes is possible.

STOP button pressed

If the alarm "*STOP button pressed*" is enabled, the alarm goes off if someone presses the **STOP** button and the PIN code is not entered within 30 seconds.

Carried away

If the alarm *Carried away* is enabled, the product senses unexpected motions, and the alarm goes off.

3.9.7.4 GeoFence

GeoFence is a GPS-based theft protection that makes a virtual fence for the product. If the product is more than a set distance away from the center position the product will be deactivated and an alarm will start. The center position will be set to the current position of the product when the function is enabled. The PIN code is needed to

deactivate the alarm and to start the product again. The GeoFence is only enabled when the product is switched on.

3.9.8 Automower® Connect (Bluetooth® only)



In *Automower® Connect* you can enable or disable the Automower® Connect module. You can also see the signal strength, connectivity status, initiate new pairing or remove the product from the paired accounts.

3.9.9 Messages

In this menu the previous fault and information messages can be found. For some of the messages, there are tips and advice to help to rectify the fault.

If the product is disrupted in any way, for example it is trapped or the battery is low, a message is saved relating to the disruption and the time it happened.

If the same message is repeated several times, this may indicate that an adjustment to the installation or the product is required. Refer to *Installation on page 11*.

3.9.10 Download firmware over the air (Firmware over the air FOTA)

The product has a function that automatically downloads new firmware. When a new firmware is available, a notification shows in the app where you can select to install the new firmware. In the factory setting this function is enabled.

4 Operation

4.1 Main switch



WARNING: Read and understand the safety chapter before you use the product.

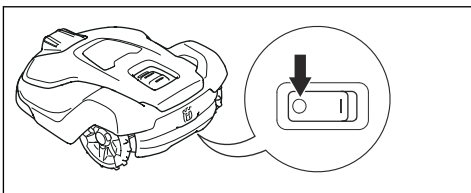

- Set the **Main switch** to the *1* position to start the product.
- Set the **Main switch** to the *0* position to set the product to OFF.

4.2 To start the product

1. Push the **STOP** button on the product.
2. Set the **Main switch** to the *1* position.
3. Open the Automower® Connect app.
4. Enter the PIN code.
5. Select an operating mode in the app. Refer to *To select operation mode Start on page 22*.
6. Push the **START** button on the product.
7. Select an operating mode in the app.

4.3 To select operation mode Start

1. Open the app on your mobile device.
2. Select *Start* and select an operation mode: *Resume Schedule*, *appDrive* or *Select work area*.

4.3.1 Resume Schedule

The product will continue to operate on the scheduled work area where it cuts the grass and charges automatically.

4.3.2 appDrive

Use the appDrive to operate the product manually.

4.3.2.1 To operate the product with appDrive

Use the buttons to operate the product:

- Use the **up** button (A) to move the product forward.
- Use the **down** button (B) to move the product rearward.
- Use the left **arrow** button (C) to rotate the product to the left.

- Use the right **arrow** button (D) to rotate the product to the right.
- Use the **center** button (E) as a joystick to move and rotate the product in any direction.

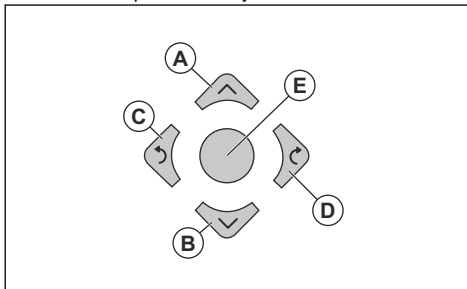

Note: Walk 2-3 m / 6.5-9.8 ft. behind the product when you operate the product with appDrive.

4.3.3 Select work area

This function lets the product temporarily operate in a selected work area. You can select a time limit for this function. After that time period, the product continues to operate as set in the schedule.

4.3.3.1 Secondary area

For the product to operate in a secondary area, you must move the product manually to and from the secondary area. The product cuts for a selected period of time or until the battery is empty.

4.4 Operating mode - Park

When you select *Park* in the app you can select the operation selections that follow:

- *Park until further notice*
- *Select duration*

4.4.1 Park until further notice

The operation mode *Park* means that the product goes back to the charging station where it stays until a new operation mode is selected and the **START** button is pushed.

4.4.2 Select duration

The product goes back to the charging station and stays for the selected park duration. Use the operation selection to temporary stop an ongoing mowing cycle and let the product to stay in the charging station.

4.4.3 Operating mode - Pause

When selecting *Pause* in the Automower® Connect app, the product stop the current activity and pause. The

product is paused until either *Park* or *Start* is selected in the Automower® Connect app.

4.5 To stop the product

1. Push the **STOP** button on top of the product.

The product stops and the cutting motor stops.

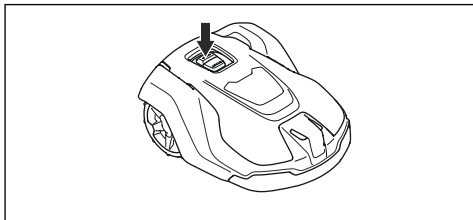

Note: When you push the **START** button again, the product continues to operate in the same operating mode as before.

4.6 To set the product to OFF

1. Push the **STOP** button.
2. Connect the product with Bluetooth® short-range in the app.

Note: The product cannot be set to OFF if it is not connected to the app with Bluetooth®.

3. Set the **Main switch** to the *0* position.

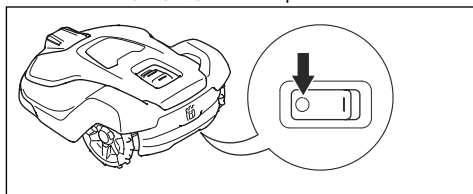

4.7 To charge the battery

When the product is new or after long-term storage, the battery can be empty. Charge the battery before you start the product.

1. Set the **Main switch** to the *1* position.
2. Put the product into the charging station until the charging plates touch the contact plates.
3. Do a check that the product charges in the Automower® Connect app.

5 Maintenance

5.1 Introduction - maintenance



WARNING: Set the product to OFF before you do maintenance on the product.



WARNING: Use protective gloves.

For better operation and lifetime of the product, make sure to clean the product regularly and replace worn parts.

When the product is new, examine the blade discs and blades each week. If the wear is low, you can increase the interval for the next time you examine the blade discs and blades. Examine the blade discs and the blades more regularly if there is much wear.

It is important that the blade disc rotates easily and that the edges of the blades are not damaged. The usual lifetime of the blades are 2 to 5 weeks. The conditions that follow can increase or decrease the lifetime of the blades:

- Operation time and dimension of the work area.
- Length and thickness of the grass.
- Soil, sand and use of fertilizers.
- Objects such as cones, tools, stones and roots in the work area.

Note: The cut result can be unsatisfactory if the blades are blunt. Refer to *Replacement of the blades on page 24* on how to replace the blades.

5.2 Clean the product

Husqvarna recommends to use a special cleaning and maintenance kit, available as an accessory. Speak to your Husqvarna representative for more information.



CAUTION: Do not use a high-pressure washer to clean the product and the charging station. Do not use solvents for cleaning.

5.2.1 To clean the chassis and blade disc

Examine the blade disc and blades weekly.

1. Set the **Main switch** to the 0 position.
2. Put the product onto its side.
3. Make sure that the blades are not damaged and that the blades and blade disc can rotate freely.

4. Clean the blade disc and chassis with a brush.

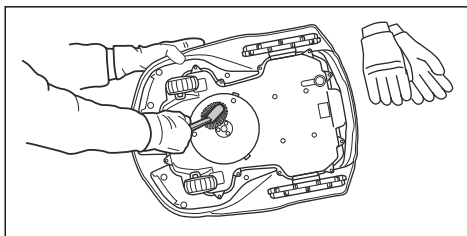

5.2.2 To clean the chassis

- Clean the bottom of the chassis with a brush or a moist cloth.

5.2.3 To clean the wheels

The product does not operate satisfactorily in slopes if the wheels are blocked with grass.

- Use a soft brush to clean the wheels.

5.2.4 To clean the body of the product

- Use a moist cloth and a weak soap solution to clean the body of the product.

5.2.5 To clean the charging station



WARNING: Disconnect the power supply from the power outlet before maintenance, or when you clean the charging station or power supply.



CAUTION: Do not use a high-pressure washer or running water to clean the charging station.

Note: The product cannot enter the charging station if there are objects in the charging station. Clean the charging station regularly.

- Remove grass, twigs and other objects from the charging station.

5.3 Replacement of the blades



WARNING: Husqvarna can only guarantee safety if you use Husqvarna original blades with the embossed crowned H-mark logotype.

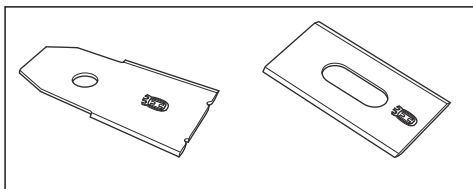

WARNING: You must replace the screws when you replace the blades. The used screws can wear quickly and make the blade come loose, this can cause serious injury.

Replace worn or damaged blades for a safe operation. Replace the blades regularly for a satisfactory cut result and a low energy use. All 3 blades and screws must be replaced at the same time to get a balanced cutting system.

5.3.1 To replace the blades

1. Push the **STOP** button.
2. Set the **Main switch** to the 0 position.

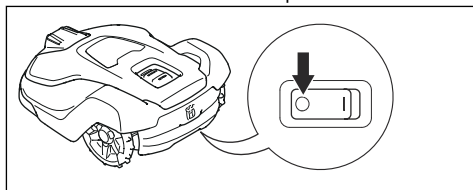

3. Put the product with the blade disc up on a soft and clean surface.
4. Rotate the skid plate until its holes align with the screws for the blade.
5. Remove the 3 screws with a screwdriver.

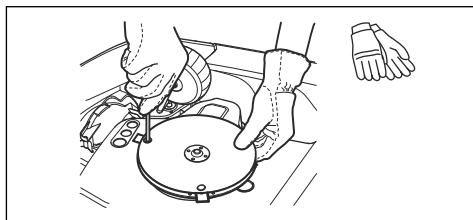

6. Remove the 3 blades.
7. Attach 3 new blades and screws.
8. Make sure that the blades can pivot freely.

5.4 Battery



CAUTION: Charge the battery fully before you put the product into storage. If

the battery is not fully charged it can cause damage to the battery.

If the operating time of the product is shorter than usual between charges, this means that the battery is at the end of its life cycle. Replace the battery to extend the operating time.

Note: The battery life is related to the length of the season and how many hours a day the product operates. A long season or many hours of operation a day means that the battery must be replaced more regularly.

5.5 Winter service

Take your product to your Husqvarna central service for service prior to winter storage. Regular winter service will maintain the product in good condition and create the best conditions for a new season without any disruptions.

Service usually includes the following:

- Thorough cleaning of the body, the chassis, the blade disc and all other moving parts.
- Testing of the product's function and components.
- Checking and, if required, replacing wear items such as blades and bearings.
- Testing the product's battery capacity as well as a recommendation to replace battery if necessary.
- If new firmware is available, the product is updated.

6 Troubleshooting

6.1 Introduction - troubleshooting

All messages can be found in the *Messages* menu in Automower® Connect. More suggestions for steps to take in the event of malfunction or symptoms can be found on www.husqvarna.com.

Note: The *Messages* menu is only available for short-range connectivity (Bluetooth®).

6.2 Fault messages

The fault messages in the table below are shown in the Automower® Connect app. Speak to your Husqvarna representative if the same message shows frequently.

Message	Cause	Action
<i>Cutting system blocked</i>	The blade disc is blocked by grass or other objects.	Examine the blade disc and remove the grass or other object.
	The blade disc is in water.	Move the product and prevent the collection of water in the work area.
	The grass is high and thick.	Adjust the cutting height to the height of the grass. Adjust the schedule settings to increase the operation time.
<i>Trapped</i>	The product is behind a number of obstacles in a small area.	Examine the area and remove the obstacles which make it hard for the product to move away from this location.

Message	Cause	Action
<i>No loop signal</i>	The power supply or the low-voltage cable for the charging station is not connected.	If the LED indicator on the charging station is out, it shows that there is no power. Examine the power outlet connection and the residual-current device. Make sure that the low-voltage cable is connected to the charging station.
	The power supply or the low-voltage cable for the charging station is damaged.	Replace the power supply or low-voltage cable.
	<i>ECO mode</i> is enabled and the LED indicator of the charging station flashes green. The product was started manually in the work area but the STOP button was not pushed before the product was moved from the charging station. The charging station signal is disabled and the product cannot enter the charging station. Refer to <i>ECO mode on page 19</i> .	Put the product in the charging station. Start the product. Refer to <i>To start the product on page 22</i> .
	The product does not find the loop signal from the charging station.	Put the product in the charging station and make a new loop signal. Refer to <i>New loop signal on page 20</i> .
	The charging station is not installed correctly.	Install the charging station according to the instruction. Refer to <i>To install the charging station on page 14</i> .
	Interference from metal objects such as fences, reinforcement steel or buried cables near the charging station.	Change the position of the charging station.
<i>Outside work area</i>	The work area slopes too much by the virtual boundary.	Make sure that the virtual boundary is installed correctly. Refer to <i>To examine where to install the objects on the map on page 13</i> .
	The transport path or the path to the maintenance point slopes too much.	Make sure that the transport path is installed correctly. Refer to <i>To install the map objects in a slope on page 13</i> .
	The product can not find the correct charging station signal because of interference with a loop signal from a different product installation nearby.	Put the product in the charging station and make a new loop signal. Refer to <i>New loop signal on page 20</i> .
	Interference from metal objects such as fences, reinforcement steel or buried cables near the charging station.	Change the position of the charging station.

Message	Cause	Action
<i>Empty battery</i>	The product cannot find the charging station.	The product has no accurate position and cannot find the charging station. There is an obstacle that prevents the product to find the charging station.
	The battery is at the end of its life cycle.	Replace the battery. Refer to <i>Battery on page 25</i> .
	The antenna of the charging station is defective.	If the LED indicator on the charging station flashes red, the antenna of the charging station is defective. Speak to your approved servicing dealer.
<i>Slipped</i>	The product has hit an obstacle and stopped or the wheels cannot move on the wet grass.	Move the product and correct the cause of problem. If it is because of wet grass, wait until the lawn is dry before you use the product.
	The work area includes a steep slope.	Maximum guaranteed slope is 45%. Steeper slopes should be isolated. Refer to <i>To install the map objects in a slope on page 13</i> .
<i>Wheel motor overloaded right, left</i>	Grass or other objects is wound around the drive wheel.	Examine the drive wheel and remove grass or other objects.
<i>Charging station blocked</i>	The connection between the charging plates on the product and the contact plates on the charging station is not good. The product made a number of tries to charge.	Put the product in the charging station and make sure that the charging plates and contact plates are connected.
	An object prevents the product to enter the charging station.	Remove the object.
	The charging station tilts or is bent.	Put the baseplate on level ground.
<i>Stuck in charging station</i>	An object prevents the product to move out from the charging station.	Remove the object.
	The baseplate has a wet or dirty surface that prevents the product to move out from the charging station.	Clean the baseplate of the charging station.
<i>Upside down</i>	The product tilts or is with the top down.	Put the product in the correct position.
<i>Mower tilted</i>	The product tilts more than the maximum angle.	Move the product to an area that has level ground.
<i>Lifted</i>	The lift sensor was enabled because the product was lifted.	Move the product. If the problem stays, speak to your approved servicing dealer.
<i>Collision</i>	The body of the product cannot move freely around its chassis.	Remove dirt or object between the chassis and the body of the product. Make sure that the body of the product can move freely around its chassis.
	The product cannot move forward or rearward.	Remove the object that prevents the product from operation.

Message	Cause	Action
<i>Wheel motor blocked right/left</i>	The wheel is blocked by grass or other objects.	Examine the wheel and remove grass or other objects.
<i>Alarm! Mower stopped</i>	The alarm was started because the product was stopped.	Adjust the security settings in the <i>Security</i> menu. Refer to <i>Security (Bluetooth® only)</i> on page 20.
<i>Alarm! Mower outside Geo-fence</i>	Alarm was started because the product was moved out of the GeoFence area.	
<i>Alarm! Mower was moved</i>	The alarm was started because the product was moved.	
<i>Electronic problem</i>	Temporary electronic or firmware problem in the product.	Restart the product. If the problem stays, speak to your approved servicing dealer.
<i>Loop sensor problem</i>		
<i>Tilt sensor problem</i>		
<i>Temporary problem</i>		
<i>Invalid sub-device combination</i>		
<i>Temporary battery problem</i>		
<i>Faulty mix of batteries</i>		
<i>Collision sensor problem</i>		
<i>Lift sensor problem</i>		
<i>Charging system problem</i>	There is corrosion or dirt on the charging plates and contact plates.	Restart the product. Clean the charging plates on the product and the contact plates on the charging station.
	Temporary electronic or firmware problem in the product.	Restart the product. If the problem stays, speak to your approved servicing dealer.
<i>Battery problem</i>	Temporary battery or firmware problem in the product.	Restart the product. If the problem stays, speak to your approved servicing dealer.
	Incorrect type of battery.	Use only original batteries recommended by the manufacturer.
<i>Battery temperature outside limits</i>	The product cannot start because the temperature in the battery is too high or too low.	The product will start to operate when the temperature of the battery has decreased. Make sure that the charging station is put in an area with protection from the sun.
<i>Charging current too high</i>	Incorrect or defective power supply unit.	Examine that the power supply unit and charging station are not defective. Make sure that you use the correct power supply unit and charging station. Restart the product. If the problem stays, speak to your approved servicing dealer.

Message	Cause	Action
<i>Map problem</i>	There is no specified work area.	Make a work area in the Automower® Connect app. Refer to <i>To make a work area on page 17</i> .
	The charging station or the reference station was moved.	Move the charging station or the reference station to their initial positions.
		Do a new installation of the map.
	The map object file is incorrect.	Do a check of the map in the app. Adjust the map and save it.
Delete the map and do a new installation.		
<i>Wheel drive problem, right/left</i>	The wheel is blocked by grass or other objects.	Examine the drive wheel and remove grass or other objects.
<i>Searching for position</i>	Weak satellite signal to the reference station.	The satellite signal is temporary weak. The product will start to operate when the satellite signals are good.
		Examine the installation of the reference station. Refer to the Operator's manual for the Reference station.
	Weak satellite signal to the product.	The satellite signal is temporary weak. The product will start to operate when the satellite signal are good.
		Examine if there is an object between the product and the sky that cause interference with the satellite signal. Remove the object or do a new installation to not include these parts in the work area. Refer to <i>Installation of the map objects on page 15</i>
<i>No accurate position from satellites</i>	Weak satellite signal to the reference station.	Examine the installation of the reference station. Refer to the Operator's manual for the Reference station.
	Weak satellite signal to the product.	Examine if there is an object between the product and the sky that cause interference with the satellite signal. Remove the object or do a new installation to not include these parts in the work area. Refer to <i>To make a work area on page 17</i>

Message	Cause	Action
<i>Reference station communication problem</i>	The product is not connected to the reference station.	Do a pairing operation between the product and the reference station.
	The reference station is not installed correctly.	Examine the installation of the reference station. Refer to the Operator's manual for the Reference station.
	The product does not receive the radio signal from the reference station in all areas where the product operates.	Test if the product has radio signal from the reference station in all of the work area. If not, make a new installation of the reference station or a new installation of the map. Refer to <i>Installation of the map objects on page 15</i> .
	Power failure.	Examine and correct the cause for the power failure of the reference station.
	There is an error in the reference station and the LED indicator flashes red.	Disconnect the power to the reference station and connect it again to restart the reference station. If the problem stays, speak to your approved servicing dealer.
	There is interference with another reference station or other radio systems in the area.	Restart the product. If the problem stays, speak to your approved servicing dealer.
<i>Unexpected cutting height adjustment</i>	The cutting height adjustment cannot move.	Examine the cutting height adjustment and remove grass or other objects. If the problem stays, speak to your approved servicing dealer.
<i>Limited cutting height range</i>		
<i>Cutting height problem</i>		
<i>Cutting height blocked</i>		
<i>Cutting system major imbalance</i>	The product senses vibrations in the blade disc.	Make sure that the blades and screws are not damaged or worn. Make sure that all blades are correctly attached. Make sure that there is only one blade attached on each position in the blade disc.
<i>Too many waypoints</i>	There are too many waypoints in the current work area.	Do a new installation of the work area, stay-out zone and transport paths. Make less waypoints. Divide the current work area into more work areas.
<i>Destination not reachable</i>	There is no transport path between the charging station and the work area or maintenance point.	Make a transport path between the charging station and the work area or maintenance point.
	The transport path is blocked and the product cannot go to the work area, charging station or maintenance point.	Make sure that the transport path is not blocked, or delete the transport path and make a new transport path.

Message	Cause	Action
<i>No power in charging station</i>	Incorrect or damaged power supply.	Examine the power supply. If it is necessary, replace the power supply.
	Power failure.	Examine and correct the cause for the power failure of the reference station.
	The connection between the charging plates on the product and the contact plates on the charging station is not good.	Make sure that the charging plates and contact plates are connected.
<i>Multiple reference stations</i>	There is more than one reference station near the work area. This can cause interference for the product from a different reference station.	Speak to your approved servicing dealer if the same problem occurs frequently.

6.3 Information and warning messages

The information messages in the table below are shown in the *Messages* menu in the Automower® Connect app. Speak to your Husqvarna representative if the same message shows frequently.

Message	Cause	Action
<i>Cutting system imbalance</i>	The product senses vibrations in the blade disc.	Examine the blades and screws for damages and wear. Make sure that all blades are correctly installed and that there is only one blade attached in each position on the blade disc.
<i>Connectivity problems</i>	Problem with the Automower® Connect module.	Restart the product. If the connection problem stays, disconnect the product from Automower® Connect and do a new pairing operation. If the problem stays, speak to your local Husqvarna representative.
<i>Wrong PIN code</i>	An incorrect PIN code has been entered. 5 tries are permitted, and the product is then blocked for a period of time.	Enter the correct PIN code. If the PIN code is incorrect, use the link in the app to send the PIN code to your registered e-mail address. If you have not registered the e-mail address, speak to your local Husqvarna representative.
<i>Ultrasonic problem</i>	Temporary electronic or firmware related problem in the product.	Restart the product. If the problem stays, speak to your approved servicing dealer.
<i>GPS navigation problem</i>		

6.4 LED indicator lamp on the charging station

For a fully functional installation, the indicator lamp in the charging station must show a solid or flashing green light. If another color shows, follow the troubleshooting guide below.

There is more help on www.husqvarna.com. If you still need help, speak to your local Husqvarna representative.

Light	Status
Green solid light	Good signals.
Green flashing light	The signals are good and <i>ECO mode</i> is activated. Refer to <i>ECO mode on page 19</i> .
Red flashing light	Interruption in the charging station's antenna. Speak to your local Husqvarna representative.
Red solid light	Fault in the circuit board or incorrect power supply in the charging station. The fault must be correct by an authorized service technician. Speak to your local Husqvarna representative.

6.5 LED indicator on the product

The LED indicator on the control panel of the product shows the current product status:

LED indicator light	Product status
Constant green	The product cuts the lawn or moves out of the charging station.
Flashes green	The product is in <i>Pause</i> mode.
Flashes red	The product stopped because of an error.
Constant yellow	The STOP button was pushed.
Flashes yellow	The PIN code must be entered to start the product.
Constant blue	The product moves to the charging station or a maintenance point. An app is connected to the product with Bluetooth®, the LED indicator is constant blue for 3 seconds.
Pulsates blue	The product charges in the charging station.
Flashes blue	The product is parked in charging station. The product can at this time find Bluetooth® and connect with Bluetooth®.
Constant white	The product is in appDrive mode.
Pulsates white	The product sets to OFF. Firmware installation is in progress.
Flashes white	New firmware must be installed.

There is more information on www.husqvarna.com. Speak to your local Husqvarna representative for more information.

6.6 Symptoms

If the product does not operate correctly, refer to the symptoms table below.

Symptoms	Cause	Action
The Main switch is set to the 0 position but the product is not set to OFF.	The Main switch is set to the 0 position but the product is not connected to the Automower® Connect app with Bluetooth®. The product is disabled but not set to OFF.	Set the Main switch to the 1 position, connect the product to the Automower® Connect app with Bluetooth® and set the Main switch to the 0 position.
The product cannot go into the charging station.	The charging station is not on a level surface.	Put the charging station on a level surface. Refer to <i>To examine where to put the charging station on page 11.</i>
	The charging station is put too far from the work area.	Make a new work area or move the charging station.
The product operates at the incorrect time.	The time and date of the product must be set.	Set the time and date. Refer to <i>Time & date on page 20.</i>
	The start and stop time for operation are incorrect.	Change the schedule settings. Refer to <i>Schedule on page 18.</i>
There is vibration in the product.	The cutting system is not in balance because of damaged blades.	Examine the blades and screws and replace them if necessary. Refer to <i>To replace the blades on page 25.</i>
	The cutting system is not in balance because of too many blades in the same position.	Do a check that only one blade is attached to each screw.
	Blades of different thickness are installed on the product.	Examine if the blades are of different thickness and replace the blades if necessary.
The product operates, but the blade disc does not rotate.	The product goes to the charging station.	Usual operation of the product. The blade disc does not rotate when the product goes to the charging station.
The product operates for shorter periods than usual between charges.	Grass or other object causes a blockage to the blade disc.	Remove and clean the blade disc. Refer to <i>To clean the chassis and blade disc on page 24.</i>
	The battery is at the end of its life cycle.	Replace the battery. Refer to <i>Battery on page 25.</i>
	The grass is high and thick.	Increase the cutting height and then decrease it when the grass is shorter.
Operation and charging times are shorter than usual.	The battery is at the end of its life cycle.	Replace the battery. Refer to <i>Battery on page 25.</i>

Symptoms	Cause	Action
The product is parked for hours in the charging station.	The product is parked because of the set <i>Schedule</i> setting, or because <i>Park until further notice</i> is selected.	Change the <i>Schedule</i> settings, or start the product.
	The product does not operate if the battery temperature is too high or too low.	The product starts to operate again when the temperature is between the set limits and the schedule settings lets the product operate. Make sure that the charging station is put in an area with protection from the sun.
The product moves in circles or spirals.	The product operates frequently in <i>Spiral cutting</i> .	Adjust the intensity of the <i>Spiral cutting</i> or disable it if it is necessary. Refer to <i>Spiral cutting on page 19</i> .
The product operates on a small area for a number of minutes.	The product follows the GPS assisted navigation.	Usual operation of the product.
The product cannot connect to the mobile device.	The product is connected to a different mobile device or app.	Disable the app in all other connected devices.
The cut result is not satisfactory.	The product operates for a short period.	Increase the cutting time. Refer to <i>Schedule on page 18</i> .
		Increase the intensity level in the <i>Weather timer</i> or disable the <i>Weather timer</i> .
	The work area is too large.	Set a limit to the work area, or extend the operation time. Refer to <i>To calculate the schedule setting on page 18</i> .
	Blunt blades.	Replace all the blades. Refer to <i>To replace the blades on page 25</i> .
	Long grass in relation to the set cutting height.	Increase the cutting height and then lower it when the grass is shorter.
	Collection of grass by the blade disc or around the motor shaft.	Remove the collection of grass and clean the product. Refer to <i>To clean the chassis and blade disc on page 24</i> .

7 Transportation, storage and disposal

7.1 Transportation

The supplied Li-ion batteries obey the Dangerous Goods Legislation requirements.

- Obey all applicable national regulations.
- Obey the special requirement on package and labels for commercial transportations, including by third parties and forwarding agents.

7.2 Storage

- Fully charge the product. Refer to *To charge the battery on page 23*.
- Disconnect the product with the **Main switch**. Refer to *To set the product to OFF on page 23*.
- Clean the product. Refer to *Clean the product on page 24*.
- Keep the product in a dry, frost free space.
- Keep the product with all wheels on level ground during storage, or use a Husqvarna wall hanger.
- If you keep the charging station indoors, disconnect and remove the power supply from the charging station.

Note: If you keep the charging station outdoors, do not disconnect the power supply and the connectors.

7.3 Disposal

- Obey the local recycling requirements and applicable regulations.
- For questions about how to remove the battery, refer to *To remove the batteries on page 36*.

7.3.1 To remove the batteries



CAUTION: Only remove the batteries when you dispose the product. When you remove the warranty seal, the Husqvarna warranty is no longer applicable.

1. Disconnect the product with the **Main switch**. Refer to *To set the product to OFF on page 23*.
2. Pull out the grommet on the charging cable at the very front of the product, and carefully remove the connector.
3. Lift the cover, one corner at a time.
4. Remove the 14 screws with a Torx 20.

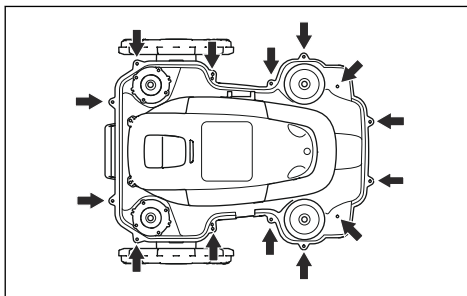

5. Lift the rear edge of the top section of the chassis.
6. Disconnect the cable from the main circuit board.
7. Remove the top section of the chassis.
8. Remove the 3 screws that holds the batteries with a Torx 20.

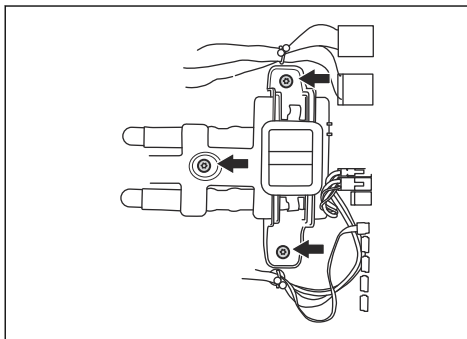

9. Disconnect the batteries connection from the main circuit board.

8 Technical data

8.1 Technical data

Dimensions	Automower® 450X EPOS	Automower® 450XH EPOS
Length, cm / in.	72 / 28.3	75 / 29.5
Width, cm / in.	56 / 22.0	63 / 24.8
Height, cm / in.	32 / 12.6	35 / 13.8
Weight, kg / lbs	14.4 / 31.7	16 / 35.3

Electrical system	Automower® 450X EPOS	Automower® 450XH EPOS
Battery, Lithium-Ion 18V, 5.0 Ah, Art. No	593 11 84-01, 593 11 85-01, 593 11 84-03, 593 11 84-04, 593 11 84-05, 593 11 84-06 (2 pcs.) 5.0 Ah/battery	593 11 84-01, 593 11 85-01, 593 11 84-03, 593 11 84-04, 593 11 84-05, 593 11 84-06 (2 pcs.) 5.0 Ah/battery
Battery, Lithium-Ion 18V, 4.9 Ah, Art. No	593 11 84-02, 593 11 85-02 (2 pcs.) 4.9 Ah/battery	593 11 84-02, 593 11 85-02 (2 pcs.) 4.9 Ah/battery
Power supply (28V DC), V AC	100-240	100-240
Low-voltage cable for charging station, length m/ft.	10 / 33	10 / 33
Mean energy consumption at maximum use	23 kWh/month in a 5000 m ² work area	23 kWh/month in a 5000 m ² work area
Charging current, A DC	7	7
Type of Power Supply Unit for charging station ⁵	FW7458/28/D/XX/Y, ADP-200JR XX	FW7458/28/D/XX/Y, ADP-200JR XX
Average mowing time, min	210	210
Average charging time, min	60	60

Charging station wire antenna	Automower® 450X EPOS	Automower® 450XH EPOS
Operating Frequency Band, Hz	100-80000	100-80000
Maximum magnetic field, dBuA/m	82	82
Maximum Radio-frequency power ⁶ , mW @60m	<25 mW @60m	<25 mW @60m

⁵ XX, YY can be any alphanumeric characters or blank for marketing purpose only, no technical differences.

⁶ Maximum active output power to antennas in the frequency band in which the radio equipment operates.

Sound data ⁷	Automower® 450X EPOS	Automower® 450XH EPOS
Sound level, perceived, dB (A)	65	68
Measured sound power noise level, dB (A)	63	65
Noise emissions uncertainties K_{WA} , dB (A)	3	3
Sound pressure noise level at the operator's ear, dB (A) ⁸	55	57

Mowing	Automower® 450X EPOS	Automower® 450XH EPOS
Cutting system	3 pivoted cutting blades	3 pivoted cutting blades
Maximum cutting motor speed, rpm	2700	2700
Power consumption during cutting, W +/- 20 %	35	37
Cutting height, cm / in.	2-6 / 0.8-2.4	5-9 / 2.0-3.6
Cutting width, cm / in.	24 / 9.4	24 / 9.4
Narrowest possible passage, m / ft.	2 / 6.5	2 / 6.5
Maximum slope for cutting area, %	45	45
Maximum slope for virtual boundary, %	15	15
Working capacity, m ² / acre(s) +/- 20%	5000 / 1.25	5000 / 1.25

IP-classification	Automower® 450X EPOS	Automower® 450XH EPOS
Robotic lawn mower	IPX4	IPX4
Charging station	IPX1	IPX1
Power supply charging station	IP44	IP44

Frequency Band Support	
Bluetooth® Frequency range	2400.0-2483.5 MHz
Automower® Connect 2G	GSM 850 MHz, E-GSM 900 MHz, DCS 1800 MHz, PCS 1900 MHz
Automower® Connect 4G	Band 12 (700 MHz), Band 17 (700 MHz), Band 28 (700 MHz), Band 13 (700 MHz), Band 20 (800 MHz), Band 26 (850 MHz), Band 5 (850 MHz), Band 19 (850 MHz), Band 8 (900 MHz), Band 4 (1700 MHz), Band 3 (1800 MHz), Band 2 (1900 MHz)
SRD915	902-928 MHz

⁷ Determined according to Directive 2006/42/EC and standard EN 50636-2-107. Except Sound level, perceived that is measured according to ISO 11094:1991.

⁸ Sound pressure noise uncertainties K_{pA} , 2-4 dB (A).

Power Class		
Bluetooth® Output power	8 dBm	
Automower® Connect 2G	Power Class 4 (GSM/E-GSM)	33 dBm
	Power Class 1 (DCS/PCS)	30 dBm
	Power Class E2 (GSM/E-GSM)	27 dBm
	Power Class E2 (DCS/PCS)	26 dBm
Automower® Connect 4G	Power Class 3	23 dBm
SRD915	13 dBm	

Full compatibility cannot be guaranteed between the product and other types of wireless systems such as remote controls, radio transmitters, hearing loops, buried electric animal fencing or similar.

The products are made in England or the Czech Republic. Refer to information on the rating plate. Refer to *Product overview on page 8*.

8.2 Registered trademarks

The *Bluetooth®* word mark and logos are registered trademarks owned by *Bluetooth SIG, inc.* and any use of such marks by Husqvarna is under license.

9 Warranty

9.1 Warranty terms

Husqvarna® warranty covers this product's functionality for a period of 2 years from date of purchase. The warranty covers serious faults relating to materials or manufacturing faults. Within the warranty period, we will replace the product or repair it at no charge if the following terms are met:

- The product and the charging station may only be used in compliance with the instructions in this Operator's Manual. This manufacturer's warranty does not affect warranty entitlements against the dealer/retailer.
- End-users or non-authorized third parties must not attempt to repair the product.

Examples of faults which are not included in the warranty:

- Damage caused by water seepage from using a high-pressure washer, or from being submerged under water, for example when heavy rain forms pools of water.
- Damage caused by lightning.
- Damage caused by improper battery storage or battery handling.
- Damage caused by using a battery that is not a Husqvarna original battery.
- Damage caused by not using Husqvarna original spare parts and accessories, such as blades and installation material.
- Damage caused by non-authorized changing or tampering with the product or its power supply.

The blades and wheels are seen as disposable and are not covered by the warranty.

If an error occurs with your Husqvarna product, please contact Husqvarna customer service for further instructions. Please have the receipt and the product's serial number at hand when contacting Husqvarna customer service.

10 Applicable to US/CA market

10.1 Supplier's Declaration of Conformity

Issuer: Husqvarna AB, Drottninggatan 2, SE-561 82 Huskvarna, Sweden www.husqvarnagroup.com.

Responsible party: Husqvarna Professional Products, Inc. 9335 Harris Corners Parkway Suite 500 Charlotte, NC 28269 United States U.S. Contact information: Michael Campbell, Sr Director Quality, test compliance, Telephone: +1 704 597 5000.

10.2 Compliance requirements

FCC ID: MCQ-XBSX (Short range device 915 MHz).

FCC ID ZASHQ-BLE-1G (Bluetooth® module).

FCC ID: XPYUBX18ZO01 (Automower® Connect 2G/4G).

The Bluetooth® module is located on the HMI-board (PCBA) in the upper chassis. All circuit boards in the mower using radio are located in the upper chassis. They must only be accessed by an authorized service technician.

harmful interference to radio or television reception, which can be determined by turning the equipment off and on, the user is encouraged to try to correct the interference by one or more of the following measures:

- Reorient or relocate the receiving antenna.
- Increase the separation between the equipment and receiver.
- Connect the equipment into an outlet on a circuit different from that to which the receiver is connected.
- Consult the dealer or an experienced radio/TV technician for help.



WARNING: Cancer and Reproductive Harm - www.P65Warnings.ca.gov.



WARNING: To comply with RF exposure requirements, please maintain a separation distance of at least 20 cm/7 inches from any part of the product.

Note: Changes or modifications made to this equipment not expressly approved by Husqvarna may void the FCC authorization to operate this equipment.

Note: This device complies with Part 15 of the FCC Rules [and with Industry Canada licence-exempt RSS standard(s)]. Operation is subject to the following two conditions: this device may not cause harmful interference, and this device must accept any interference received, including interference that may cause undesired operation.

Note: This equipment has been tested and found to comply with the limits for a Class B digital device, pursuant to part 15 of the FCC Rules. These limits are designed to provide reasonable protection against harmful interference in a residential installation. This equipment generates, uses and can radiate radio frequency energy and, if not installed and used in accordance with the instructions, may cause harmful interference to radio communications. However, there is no guarantee that interference will not occur in a particular installation. If this equipment does cause



Husqvarna[®]

AUTOMOWER[®] is a trademark owned by Husqvarna AB.
Copyright[®] 2022 HUSQVARNA. All rights reserved.

www.husqvarna.com

Original instructions



1143191-95



2022-10-13