



 **Husqvarna**[®]



520iHD60, 520iHD70

Contents

Introduction.....	2	Troubleshooting.....	13
Safety.....	4	Transportation, storage and disposal.....	14
Assembly.....	10	Technical data.....	15
Operation.....	10	Declaration of Conformity.....	17
Maintenance.....	12		

Introduction

Product description

Husqvarna 520iHD60, 520iHD70 is a battery hedge trimmer with an electrical motor.

Work is constantly in progress to increase your safety and efficiency during operation. Speak to your servicing dealer for more information.

Intended use

Use the product to cut branches and twigs. Do not use the product for other tasks.

Product overview

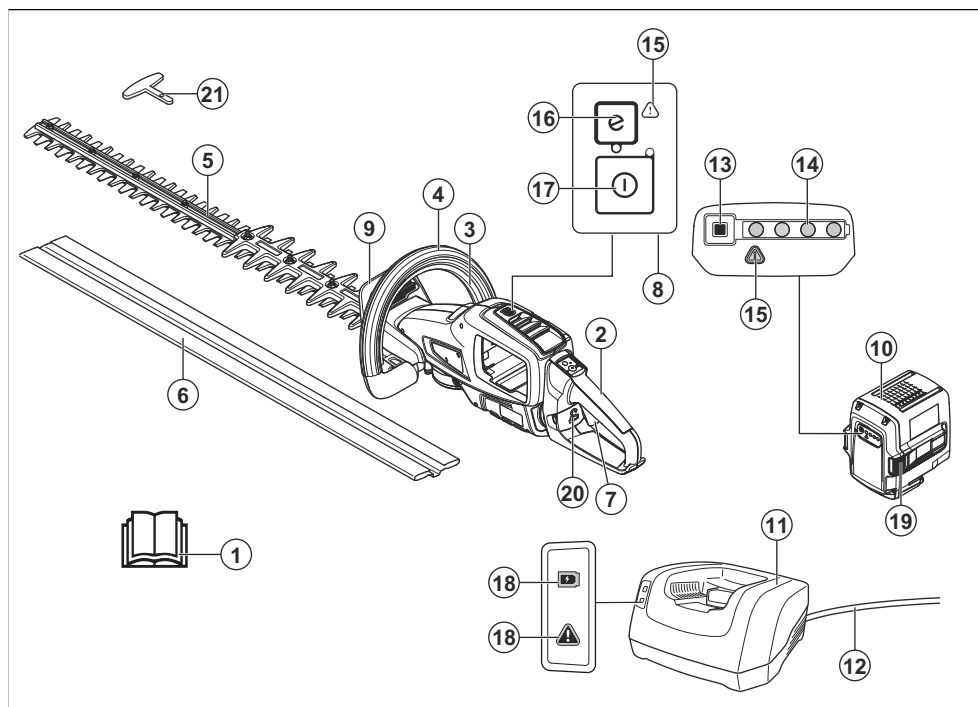

- | | |
|--------------------------|---------------------|
| 1. Operator's manual | 7. Power trigger |
| 2. Rear handle | 8. Keypad |
| 3. Power trigger lockout | 9. Hand guard |
| 4. Front handle | 10. Battery |
| 5. Blade and blade guard | 11. Battery charger |
| 6. Transport guard | 12. Cord |

13. Battery indicator button
14. Battery status
15. Warning indicator
16. SavE button
17. Start and stop button
18. Power on and warning indicator
19. Battery release buttons
20. Lock for handle
21. Blade tip protection

Symbols on the product



WARNING! This product is dangerous. Injury or death can occur to the operator or bystanders if the product is not used carefully and correctly. To prevent injury to the operator or bystanders, read and obey all safety instructions in the operator's manual. Please read the operator's manual carefully and make sure that you understand the instructions before use.



Use approved eye protection.



Use approved protective gloves.



The product agrees with the applicable EC directives.



This product conforms to the applicable UK regulations.



The product or package cannot be disposed as domestic waste. The product and package must be sent to a correct recycling station for the recovery of electrical and electronic equipment. (Applies to Europe only)

IPX4

Protected against splashing water.



Direct current.



Noise emission to the environment label as per EU and UK directives and regulations, and New South Wales legislation "Protection of the Environment Operations (Noise Control) Regulation 2017". The guaranteed sound power level of the product is specified in *Technical data on page 15* and on the label.



Lock for handle adjustment.

yyyyywwxxxx

The rating plate shows the serial number. **yyyyy** is the production year, **ww** is the production week and **xxxxx** is the sequential number.

Note: Other symbols/decals on the product refer to certification requirements for some markets.

Symbols on the battery and/or on the battery charger

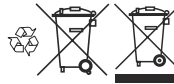

Recycle this product at a recycling station for electrical and electronic equipment. (Applies to Europe only)



Fail-safe transformer.



Use and keep the battery charger indoors only.



Double insulation.

Product damage

We are not responsible for damages to our product if:

- the product is incorrectly repaired.
- the product is repaired with parts that are not from the manufacturer or not approved by the manufacturer.
- the product has an accessory that is not from the manufacturer or not approved by the manufacturer.

- the product is not repaired at an approved service center or by an approved authority.

Safety

Safety definitions

Warnings, cautions and notes are used to point out specially important parts of the manual.



WARNING: Used if there is a risk of injury or death for the operator or bystanders if the instructions in the manual are not obeyed.



CAUTION: Used if there is a risk of damage to the product, other materials or the adjacent area if the instructions in the manual are not obeyed.

Note: Used to give more information that is necessary in a given situation.

General power tool safety warnings



WARNING: Read all safety warnings and all instructions. Failure to follow the warnings and instructions may result in electric shock, fire and/or serious injury.

Note: Save all warnings and instructions for future reference. The term "power tool" in the warnings refers to your mains-operated (corded) power tool or battery-operated (cordless) power tool.

Work area safety

- **Keep work area clean and well lit.** Cluttered or dark areas invite accidents.
- **Do not operate power tools in explosive atmospheres, such as in the presence of flammable liquids, gases or dust.** Power tools create sparks which may ignite the dust or fumes.
- **Keep children and bystanders away while operating a power tool.** Distractions can cause you to lose control.

Electrical safety

- **Power tool plugs must match the outlet. Never modify the plug in any way. Do not use any adapter plugs with earthed (grounded) power tools.** Unmodified plugs and matching outlets will reduce risk of electric shock.
- **Avoid body contact with earthed or grounded surfaces, such as pipes, radiators, ranges and refrigerators.** There is an increased risk of electric shock if your body is earthed or grounded.

- **Do not expose power tools to rain or wet conditions.** Water entering a power tool will increase the risk of electric shock.
- **Do not abuse the cord. Never use the cord for carrying, pulling or unplugging the power tool. Keep cord away from heat, oil, sharp edges or moving parts.** Damaged or entangled cords increase the risk of electric shock.
- **When operating a power tool outdoors, use an extension cord suitable for outdoor use.** Use of a cord suitable for outdoor use reduces the risk of electric shock.
- **If operating a power tool in a damp location is unavoidable, use a residual current device (RCD) protected supply.** Use of a RCD reduces the risk of electric shock.

Personal safety

- **Stay alert, watch what you are doing and use common sense when operating a power tool. Do not use a power tool while you are tired or under the influence of drugs, alcohol or medication.** A moment of inattention while operating power tools may result in serious personal injury.
- **Use personal protective equipment. Always wear eye protection.** Protective equipment such as dust mask, non-skid safety shoes, hard hat or hearing protection used for appropriate conditions will reduce personal injuries.
- **Prevent unintentional starting. Ensure the switch is in the OFF-position before connecting to a power source and/or battery pack, picking up or carrying the tool.** Carrying power tools with your finger on the switch or energising power tools that have the switch on invites accidents.
- **Remove any adjusting key or wrench before turning the power tool on.** A wrench or a key left attached to a rotating part of the power tool may result in personal injury.
- **Do not overreach. Keep proper footing and balance at all times.** This enables better control of the power tool in unexpected situations.
- **Dress properly. Do not wear loose clothing or jewellery. Keep your hair and clothing away from moving parts.** Loose clothes, jewellery or long hair can be caught in moving parts.
- **If devices are provided for the connection of dust extraction and collection facilities, ensure these are connected and properly used.** Use of dust collection can reduce dust-related hazards.
- **Do not let familiarity gained from frequent use of tools allow you to become complacent and ignore tool safety principles.** A careless action can cause severe injury within a fraction of a second.

- The vibration emission during actual use of the power tool can differ from the declared total value depending on the ways in which the tool is used. Operators should identify safety measures to protect themselves that are based on an estimation of exposure in the actual conditions of use (taking account of all parts of the operating cycle such as the times when the tool is switched off and when it is running idle in addition to the trigger).

Power tool use and care

- **Do not force the power tool. Use the correct power tool for your application.** The correct power tool will do the job better and safer at the rate for which it was designed.
- **Do not use the power tool if the switch does not turn it on and off.** Any power tool that cannot be controlled with the switch is dangerous and must be repaired.
- **Disconnect the plug from the power source and/or remove the battery pack, if detachable, from the power tool before making any adjustments, changing accessories, or storing power tools.** Such preventive safety measures reduce the risk of starting the power tool accidentally.
- **Store idle power tools out of the reach of children and do not allow persons unfamiliar with the power tool or these instructions to operate the power tool.** Power tools are dangerous in the hands of untrained users.
- **Maintain power tools and accessories. Check for misalignment or binding of moving parts, breakage of parts and any other condition that may affect the power tool's operation. If damaged, have the power tool repaired before use.** Many accidents are caused by poorly maintained power tools.
- **Keep cutting tools sharp and clean.** Properly maintained cutting tools with sharp cutting edges are less likely to bind and are easier to control.
- **Use the power tool, accessories and tool bits etc. in accordance with these instructions, taking into account the working conditions and the work to be performed.** Use of the power tool for operations different from those intended could result in a hazardous situation.
- **Keep handles and grasping surfaces dry, clean and free from oil and grease.** Slippery handles and grasping surfaces do not allow for safe handling and control of the tool in unexpected situations.

Battery tool use and care

- **Recharge only with the charger specified by the manufacturer.** A charger that is suitable for one type of battery pack may create a risk of fire when used with another battery pack.
- **Use power tools only with specifically designated battery packs.** Use of any other battery packs may create a risk of injury and fire.
- **When battery pack is not in use, keep it away from other metal objects, like paper clips, coins, keys,**

nails, screws or other small metal objects, that can make a connection from one terminal to another. Shorting the battery terminals together may cause burns or a fire.

- **Under abusive conditions, liquid may be ejected from the battery; avoid contact. If contact accidentally occurs, flush with water. If liquid contacts eyes, additionally seek medical help.** Liquid ejected from the battery may cause irritations or burns.
- **Do not use a battery pack or tool that is damaged or modified.** Damaged or modified batteries may exhibit unpredictable behavior resulting in fire, explosion or risk of injury.
- **Do not expose a battery pack or tool to fire or excessive temperature.** Exposure to fire or temperature above 130 °C (265 °F) may cause explosion.
- **Follow all charging instructions and do not charge the battery pack or tool outside the temperature range specified in the instructions.** Charging improperly or at temperatures outside the specified range may damage the battery and increase the risk of fire.

Service

- **Have your power tool serviced by a qualified repair person using only identical replacement parts.** This will ensure that the safety of the power tool is maintained.
- **Never service damaged battery packs.** Service of battery packs should only be performed by the manufacturer or authorized service providers.

Hedge trimmer safety warnings - Personal safety

- **Keep all parts of the body away from the cutter blade. Do not remove cut material or hold material to be cut when blades are moving. Make sure the switch is off when clearing jammed material.** A moment of inattention while operating the hedge trimmer may result in serious personal injury.
- **Carry the hedge trimmer by the handle with the cutter blade stopped. When transporting or storing the hedge trimmer always fit the cutting device cover.** Proper handling of the hedge trimmer will reduce possible personal injury from the cutter blades.
- **Hold the power tool by insulated gripping surface only, because the cutter blade may contact hidden wiring or its own cord.** Cutter blades contacting a "live" wire may make exposed metal parts of the power tool "live" and could give the operator an electric shock.
- **Keep cable away from cutting area.** During operation the cable may be hidden in shrubs and can be accidentally cut by the blade.

General safety instructions



WARNING: Read the warning instructions that follow before you use the product.

- Remove the battery to prevent the product from being started by accident.
 - This product is a dangerous tool if you are not careful or if you use the product incorrectly. This product can cause serious injury or death to the operator or others.
 - Do not use the product if it is changed from its initial specification. Do not change a part of the product without approval from the manufacturer. Only use parts that are approved by the manufacturer. Injury or death is a possible result of incorrect maintenance.
 - Do a check of the product before use. See, *To do before you start the product on page 11 and Maintenance schedule on page 12*. Do not use a product that is damaged or does not operate correctly. Do the safety checks, maintenance and service instructions described in this manual.
 - Children should be supervised to ensure that they do not play with the product. Never allow children or other persons not trained in the use of the product and/or the battery to use or service it. Local laws may regulate the age of the user.
 - Keep the product in a locked area to prevent access for children or persons that are not approved.
 - Store the product out of reach of children.
 - Under no circumstances may the design of the product be modified without the permission of the manufacturer. Always use original accessories. Non-authorized modifications and/or accessories can result in serious personal injury or the death of the operator and others.
-

Note: National or Local laws can regulate the use. Comply to given regulations.

Safety instructions for operation



WARNING: Read the warning instructions that follow before you use the product.

- If you encounter a situation where you are uncertain how to proceed you should ask an expert. Contact your dealer or your service workshop. Avoid all usage which you consider to be beyond your capability.
- Never use the product if you are fatigued, while under the influence of alcohol or drugs, medication or anything that could affect your vision, alertness, coordination or judgment.

- Working in bad weather is tiring and often brings added risk. Due to the added risk, it is not recommended to use the machine in very bad weather, for instance in dense fog, heavy rain, strong winds, intense cold, risk of lightning, etc.
- Faulty blades can increase the risk of accidents.
- Do not allow children to use or be in the vicinity of the product. Since the product is easy to start, children may be able to start it if they are not kept under full surveillance. This can mean a risk of serious personal injury. Disconnect the battery when the product is not under close supervision.
- Ensure that no people or animals come closer than 15 metres while you work. When several operators are working in the same area the safety distance should be at least 15 metres. Otherwise there is a risk of serious personal injury. Stop the product immediately if anyone approaches. Never swing the product around without first checking behind you to make sure that no one is within the safety zone.
- Ensure that people, animals or other things can not affect your control of the product or that they do not come in contact with the cutting attachment or loose objects that are thrown out by the cutting attachment. However, do not use the product unless you are able to call for help in the event of an accident.
- Always inspect the working area. Remove all loose objects such as stones, broken glass, nails, steel wire, string, etc., that could be thrown out or become wrapped around the cutting attachment.
- Make sure that you can move and stand safely. Check the area around you for possible obstacles (roots, rocks, branches, ditches, etcetera) in case you have to move suddenly. Take great care when you work on sloping ground.
- Keep a good balance and a firm foothold at all times. Do not overreach.
- Deactivate the product before you move to another area. Attach the transport guard when the product is not in use.
- Never put the product down unless you have deactivated it and removed the battery. Do not leave the product unsupervised when it is switched on.
- Make sure that no clothes or parts of the body come in contact with the cutting attachment when the product is activated.
- If anything jams in the blades while you operate the product, stop and deactivate the product. Make sure that the cutting attachment stops completely. Remove the battery before you clean, inspect or repair the product and/or the blades.
- Keep your hands and feet away from the cutting attachment until it has stopped completely when the product is deactivated.
- Watch out for stumps of branches that can be thrown out when you cut. Do not cut too close to the ground where stones and other objects can be thrown out.

- Watch out for thrown objects. Always wear approved eye protection. Never lean over the cutting attachment guard. Stones, rubbish, etcetera, can be thrown up into the eyes which can cause blindness or serious injury.
- Listen out for warning signals or shouts when you wear hearing protection. Always remove your hearing protection as soon as the product stops.
- Never work from a ladder, stool or any other raised position that is not fully secured.
- Use both hands when you hold the product. Hold the product at the side of your body.

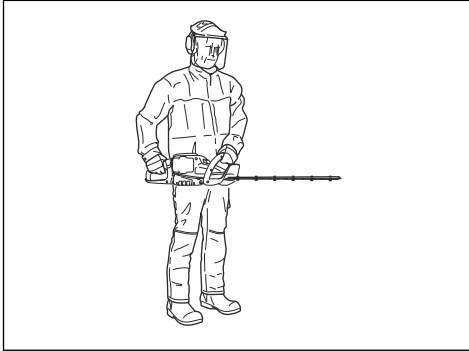

Personal protective equipment



WARNING: Read the warning instructions that follow before you use the product.

- Always use approved personal protective equipment when you use the product. Personal protective equipment cannot fully prevent injury but it decreases the degree of injury if an accident does occur. Let your dealer help you select the right equipment.
- Use a protective helmet where there is a risk of falling objects.
- Long term exposure to noise can result in damaged hearing. In general, battery powered products are relatively quiet but damage can result from a combination of noise level and long usage. Husqvarna recommends that operators use hearing protectors when using products for a longer coherent time of a day. Continual and regular users should have their hearing checked regularly.



WARNING: Hearing protectors limit the ability to hear sounds and warning signals.

- Use approved eye protection. If you use a visor, you must also use approved protective goggles. Approved protective goggles must comply with the ANSI Z87.1 standard in the USAs or EN 166 in EU countries.

- Use a visor for face protection. A visor is not enough for protection of the eyes.

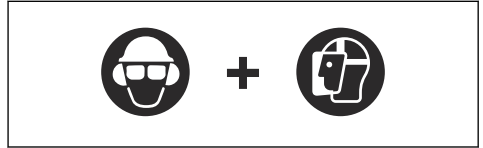

- Use gloves when necessary, for example when you attach, examine or clean the cutting equipment.
- Use sturdy non-slip boots or shoes.
- Use clothing made of a strong fabric. Always use heavy, long pants and long sleeves. Do not use loose clothing that can catch on twigs and branches. Do not wear jewelry, short pants, sandals or go with bare feet. Put your hair up safely above shoulder level.



- Keep first aid equipment close at hand.

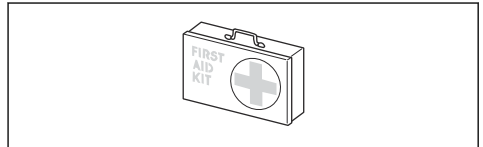

Safety devices on the product



WARNING: Read the warning instructions that follow before you use the product.

In this section the product's safety features, its purpose and how checks and maintenance should be carried out to ensure that it operates correctly. See instructions under the heading *Product overview on page 2* to find where these parts are located on your product.

The life span of the product can be reduced and the risk of accidents can increase if product maintenance is not carried out correctly and if service and/or repairs are not carried out professionally. If you need further information please contact your nearest servicing dealer.



WARNING: Never use a product with damaged safety components. The product's safety equipment must be inspected and maintained as described in this section. If your product fails any of these checks, contact your service agent to get it repaired.



CAUTION: All servicing and repair work on the machine requires special training. This is especially true of the machine's safety equipment. If your machine fails any of the checks described below you must contact your service agent. When you buy any of our products we guarantee the availability of professional repairs and service. If the retailer who sells your machine is not a servicing dealer, ask him for the address of your nearest service agent.

3. Push the power trigger up and apply full power.

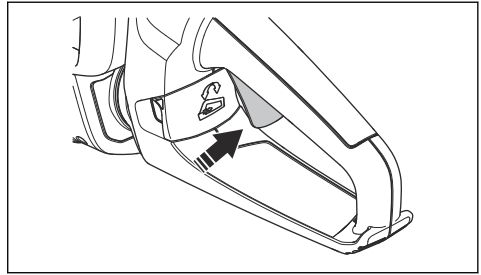

4. Release the power trigger and make sure that the return spring operates correctly. The blade must stop in less than 1 second.
5. Stop the product.
6. Do step 1 and 2.
7. Release the power trigger lockout and make sure that the return spring of the power trigger lockout operates correctly. The blade must stop in less than 1 second.

To do a check of the hand guard

The hand guard prevents hands from accidental contact with the blades.

1. Stop the product.
2. Remove the battery.
3. Check that the hand guard is attached correctly.
4. Examine the hand guard for damages.

To do a check of the blades and blade guards

1. Stop the product.
2. Remove the battery.
3. Put on protective gloves.
4. Make sure that the blades (A) and blade guard (B) are not damaged or twisted. Replace the blades and blade guards if they are damaged or bent.

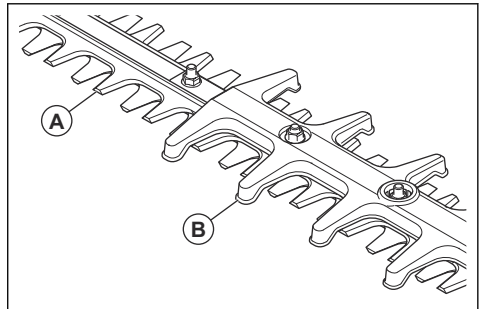

To do a check of the keypad

1. Press and hold the start/stop button (1).

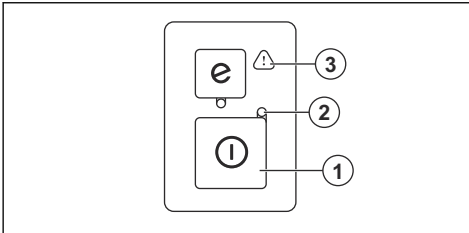

- a) The product is switched on when the LED (2) is lit.
 - b) The product is switched off when the LED (2) is out.
2. See *Keypad on page 13* if the warning indicator (3) is lit or flashes.

To do a check of the power trigger and power trigger lockout

1. Start the product, refer to *To start the product on page 11*.
2. Push the power trigger lockout up.

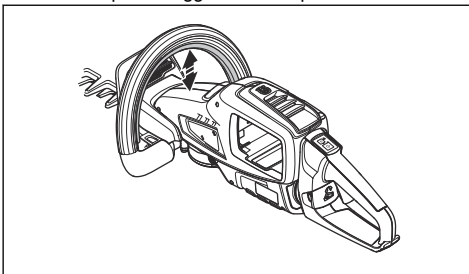

Battery safety



WARNING: Read the warning instructions that follow before you use the product.

- Only use the BLi battery. Refer to *Technical data on page 15*. The battery is software encrypted.
- Use the BLi battery that is rechargeable as a power supply for the related Husqvarna products only. To prevent injury, do not use the battery as a power supply for other devices.
- Risk of electrical shock. Do not connect the battery terminals to keys, coins, screws or other metal. This can cause a short circuit of the battery.
- Do not use non-rechargeable batteries.
- Do not put objects into the air slots of the battery.
- Keep the battery away from sunlight, heat or open flame. The battery can cause burns and/or chemical burns.
- Keep the battery away from rain and wet conditions.
- Keep the battery away from microwaves and high pressure.
- Do not try to disassemble or break the battery.
- If the battery leaks, do not let the liquid touch your body or eyes. If you have touched the liquid, clean the area with a large quantity of water and soap, and get medical aid. If you get liquid in your eyes, do not rub but flush with water for a minimum of 15 minutes and get medical aid.
- Use the battery in temperatures between -10 °C (14 °F) and 40 °C (114 °F).
- Do not clean the battery or the battery charger with water. Refer to *To clean the product, the battery and the battery charger on page 13*.
- Do not use a defective or damaged battery.
- Keep batteries in storage away from metal objects such as nails, screws or jewelry.
- Keep the battery away from children.

Battery charger safety



WARNING: Read the warning instructions that follow before you use the product.

- Risk of electrical shock or short circuit if the safety instructions are not obeyed.
- Do not use other battery chargers than the one supplied for your product. Only use QC chargers when you charge BLi replacement batteries.
- Do not try to disassemble the battery charger.
- Do not use a defective or damaged battery charger.
- Do not lift the battery charger by the power cord. To disconnect the battery charger from a mains socket, pull out the plug. Do not pull the power cord.
- Keep all cables and extension leads away from water, oil and sharp edges. Make sure that the cable

is not caught between objects, for example, doors, fences or equivalent.

- Do not use the battery charger near flammable materials or materials that can cause corrosion. Make sure that the battery charger is not covered. Pull out the plug to the battery charger if there is smoke or fire.
- Only charge the battery indoors in a location with good airflow and away from sunlight. Do not charge the battery outdoors. Do not charge the battery in wet conditions.
- Only use the battery charger where the temperature is between 5 °C (41 °F) and 40 °C (104 °F). Use the charger in an environment which has a good airflow, dry and free from dust.
- Do not put objects into the cooling slots of the battery charger.
- Do not connect the battery charger terminals to metal objects as this can short circuit the battery charger.
- Use approved mains sockets that are not damaged. Make sure that the cord of the battery charger is not damaged. If extension cables are used, make sure that the extension cables are not damaged.

Safety instructions for maintenance



WARNING: Read the warning instructions that follow before you do maintenance on the product.

- Remove the battery before you do maintenance, other checks or assemble the product.
- The operator must only do the maintenance and servicing shown in this operator's manual. Turn to your servicing dealer for maintenance and servicing of a larger extension.
- Do not clean the battery or the battery charger with water. Strong detergent can cause damage to the plastic.
- If you do not do maintenance, it decreases the life cycle of the product and increases the risk of accidents.
- Special training is necessary for all servicing and repair work, especially for the safety devices on the product. If not all checks in this operator's manual are approved after you have done maintenance, turn to your servicing dealer. We guarantee that there are professional repairs and servicing available for your product.
- Keep the teeth of the blade correctly sharpened. Obey our recommendations. Also refer to the instructions on the blade package.
- Only use original spare parts.
- Always use heavy duty gloves when you repair the cutting attachment. The blades are very sharp and can easily cause injuries.

Assembly

Introduction



WARNING: Read and understand the safety chapter before you assemble the product.

To connect the battery charger

1. Connect the battery charger to the voltage and frequency that is specified on the rating plate.
2. Put the plug in a grounded socket outlet. The LED on the battery charger flashes green one time.

Note: The battery does not charge if the battery temperature is more than 50 °C/122 °F. If the temperature is more than 50 °C/122 °F, the battery charger makes the battery become cool before the battery charges.

To connect the battery to the product



WARNING: Only use the original Husqvarna battery in the product.

1. Fully charge the battery.
2. Put the battery into the battery holder of the product.

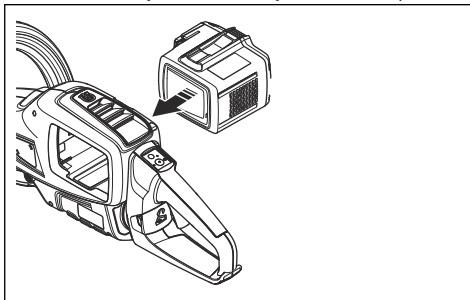

- a) Make sure that the battery is installed correctly. If the battery can not move easily, the installation of the battery is not correct.
- b) Make sure that the battery locks into position. When you hear a click, the battery locks.

Battery information

Refer to the operator's manual of the battery for information about how to use the battery.

Operation

Introduction



WARNING: Read and understand the safety chapter before you use the product.

To charge the battery

Note: Charge the battery if it is the first time that you use it. A new battery is only 30% charged.

1. Make sure that the battery is dry.
2. Put the battery in the battery charger.

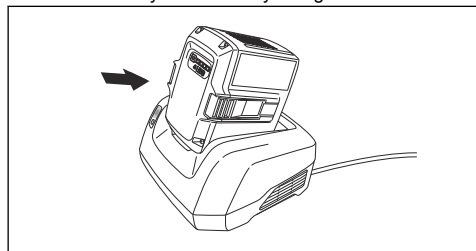

3. Make sure that the green charging light on the battery charger comes on. That means that the battery is connected correctly to the battery charger.

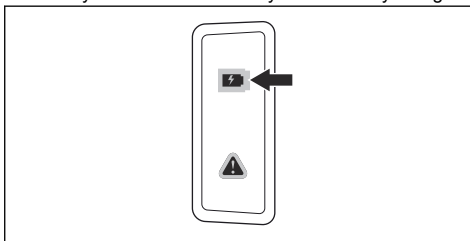

4. When all LEDs on the battery come on, the battery is fully charged.

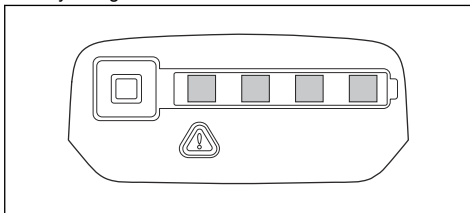

5. To disconnect the battery charger from the mains socket, pull the plug. Do not pull the cable.

- Remove the battery from the battery charger.

Note: Refer to the battery and battery charger manuals for more information.

To do before you start the product

- Examine the work area. Remove objects that can be thrown out.
- Examine the cutting attachment. Make sure that the blades are sharp, and have no cracks and damages.
- Make sure that the product works correctly. Examine that all nuts and screws are tight.
- Make sure that the handle and safety devices are not damaged and are attached correctly. Do not operate a product with missing parts or is changed from its initial specification. Use protective gloves when it is necessary.
- Make sure that the covers are not damaged and are attached correctly, before you operate the product.

To start the product

- Push and hold the start/stop button until the green LED comes on.

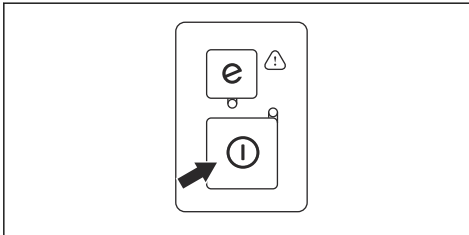

- Push and hold the power trigger lockout on the front handle.

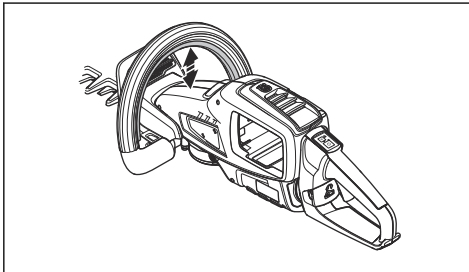

- To apply full speed, push the power trigger fully.

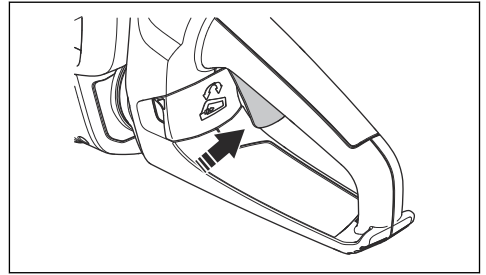

To operate the product

- Start near the ground and move the product up along the hedge when you cut the sides.

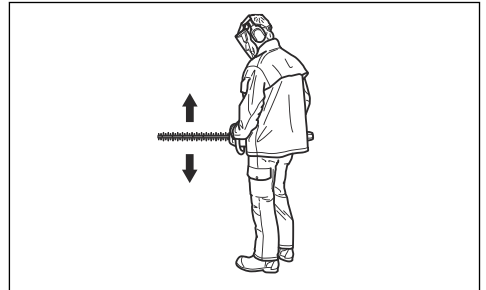

- Adjust the speed to align with the work load.
- Hold the product near your body for a stable work position.
- Make sure that the tip of the cutting equipment does not touch the ground.
- Be careful and work slowly until all the branches are correctly cut.

To start the SavE function

The product has a battery saving function, SavE.

- Push the SavE button to start the function. A green LED comes on to show that the function is on.

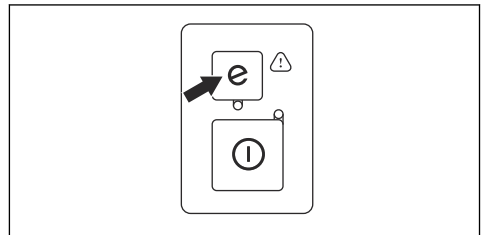

Automatic shutdown function

The product has an automatic shutdown function that stops the product if it is not used. The green LED for start/stop indication goes off and the product stops after 45 seconds.

To adjust the angle of the product

To get the best operation position, this product can be adjusted in 5 different positions. If the angle is adjusted, make sure that the bottom of the rear handle points down when you operate the product.

1. Release the handle lock and turn the handle.

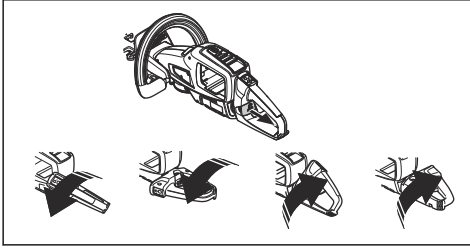

WARNING: Do not operate the cutting attachment when you adjust the handle.

To stop the product

1. Release the power trigger or the power trigger lockout.
2. Push the start/stop button until the green LED goes out.
3. Push the release buttons on the battery and pull the battery out.

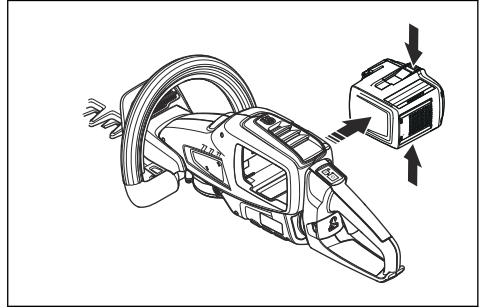

Maintenance

Introduction



WARNING: Read and understand the safety chapter before you do maintenance work on the product.



WARNING: Remove the battery before you do maintenance on the product.

Maintenance schedule



WARNING: Remove the battery before you do maintenance.

The following is a list of the maintenance steps that you must do on the product.

Maintenance	Before use	Weekly	Monthly
Clean the external parts of the product.	X		
Examine that the start and stop switch works correctly and is not damaged.	X		
Make sure that the power trigger and the power trigger lockout function correctly from a safety point of view.	X		
Make sure that all controls work and are not damaged.	X		
Make sure that the cutter blade and cutter guard have no cracks and that they are not damaged. Replace the cutter blade or the cutter guard if they have cracks or if they have been exposed to impact.	X		
Speak to your dealer to replace the cutter blade if it is bent or damaged.	X		
Make sure that the hand guard is not damaged. Replace the guard if it is damaged.	X		
Make sure that the screws and nuts are tight.	X		
Make sure that the battery is not damaged.	X		

Maintenance	Before use	Weekly	Monthly
Make sure that the battery is charged.	X		
Make sure that the battery charger is not damaged.	X		
Make sure that the screws that hold the cutter blades together are correctly tightened.		X	
Do a check of the connections between the battery and the product. Do a check of the connection between the battery and the battery charger.			X

To examine the battery and the battery charger

1. Examine the battery for damages, for example cracks.
2. Examine the battery charger for damages, for example cracks.
3. Make sure that the connection cord of the battery charger is not damaged and that there are no cracks in it.

To clean the product, the battery and the battery charger

1. Clean the product with a dry cloth after use.
2. Clean the battery and battery charger with a dry cloth. Keep the battery guide tracks clean.

3. Make sure that the terminals on the battery and the battery charger are clean before the battery is put in the battery charger or the product.

To examine the blade

1. Clean the blade from unwanted materials with an anti corrosion cleaning agent before and after you use the product.
2. Examine the edges of the blade for damages and deformation.
3. Use a file to remove burrs on the blade.
4. Make sure that the blades move freely.

To lubricate the blade

1. Lubricate the blade bars with a recommended spray grease before long periods of storage.

Troubleshooting

Keypad

Problem	Possible faults	Possible solution
Green start LED flashes.	Low battery voltage.	Charge the battery.
Red error LED flashes.	Overload.	The cutting attachment is blocked. stop the product. Remove the battery. Clean the cutting attachment from unwanted materials. Loosen the chain.
	Temperature deviation.	Let the product become cool.
	The power trigger and the start button are pushed at the same time.	Release the power trigger and push the start button.
The product does not start.	Dirt in the battery connectors.	Clean the battery connectors with compressed air or a soft brush.
Red error LED comes on.	It is necessary to do servicing on the product.	Speak to your servicing dealer.

Battery

Problem	Possible faults	Possible solution
Green LED flashes.	Low battery voltage.	Charge the battery.
Red error LED flashes.	The battery is empty.	Charge the battery.
	Temperature deviation.	Use the battery in temperatures between -10°C (14°F) and 40°C (104°F).
	Overvoltage.	Remove the battery from the battery charger.
Red error LED comes on.	Cell difference is too much (1V).	Speak to your servicing dealer.

Battery charger

Problem	Possible faults	Possible solution
Red error LED flashes.	Temperature deviation.	Use the battery charger in temperatures between 5 °C (41 °F) and 40 °C (104 °F).
Red error LED comes on.		Speak to your servicing dealer.

Transportation, storage and disposal

Transportation and storage

- The supplied Li-ion batteries obey the Dangerous Goods Legislation requirements.
- Obey the special requirement on package and labels for commercial transportation, including by third parties and forwarding agents.
- Speak to a person with special training in dangerous material before you send the product. Obey all applicable national regulations.
- Use tape on open contacts when you put the battery in a package. Put the battery in the package tightly to prevent movement.
- Remove the battery for storage or transportation.
- Put the battery and the battery charger in a space that is dry and free from moisture and frost.
- Do not keep the battery in an area where static electricity can occur. Do not keep the battery in a metal box.
- Put the battery in storage where the temperature is between 5°C/41°F and 25°C/77°F and away from open sunlight.
- Put the battery charger in storage where the temperature is between 5 °C/41 °F and 45°C/113°F and away from open sunlight.

- Use the battery charger only when the surrounding temperature is between 5°C/41°F and 40°C/104°F.
- Charge the battery 30% to 50% before you put it in storage for long periods.
- Put the battery charger in storage in a space that is closed and dry.
- Keep the battery away from the battery charger during storage. Do not let children and other not approved persons touch the equipment. Keep the equipment in a space that you can lock.
- Clean the product and do a full servicing before you put the product in storage for a long time.
- Use the transportation guard on the product to prevent injuries or damage on the product during transportation and storage.
- Attach the product safely during transportation.

Disposal of the battery, battery charger and product

The symbol below means that the product is not domestic waste. Recycle it at a recycling station

for electrical and electronic equipment. This helps to prevent damage to the environment and to persons.

Speak to local authorities, domestic waste service or your dealer for more information.



Note: The symbol shows on the product or package of the product.

Technical data

Technical data

	520iHD60	520iHD70
Motor		
Motor type	PMDC (4-brush)	PMDC (4-brush)
Weight		
Weight without battery, kg	3.8	3.9
Weight with battery (Default battery BLi200), kg	4.6	4.7
Cutting equipment		
Type	Double sided	Double sided
Blade length, mm	600	700
Blade speed cuts/min in the SavE mode	3200	3200
Blade speed cuts/min not in the SavE mode	4000	4000
Water protection level		
IPX4 ¹	Yes	Yes
Noise emissions ²		
Sound power level, measured dB(A)	89	89
Sound power level, guaranteed L _{WA}	94	94
Sound levels		
Sound pressure level at the operator's ear, measured according to EN 60745-1 and EN 60745-2-15, dB(A)	78	78

¹ The Husqvarna Handheld Battery products marked with IPX4 fulfils these requirements on product approval level

² Noise emissions in the environment measured as sound power (L_{WA}) in conformity with EC directive 2000/14/EC. The difference between guaranteed and measured sound power is that guaranteed sound power also includes dispersion in the measurement result and the variations between different products of the same model refer to Directive 2000/14/EC.

	520iHD60	520iHD70
Vibration levels ³		
Vibration levels (a_h) at handles refer to EN 60745-1 and EN 60745-2-15, m/s ² Front/ rear handles	1.6/2.5	2.3/3.5

Approved batteries

Only use original BLI batteries for this product.

Approved battery chargers

Battery charger	QC330	QC500
Input voltage, V	100-240	100-240
Frequency, Hz	50-60	50-60
Power, W	330	500

³ Reported date for vibration level has a typical statistical dispersion (standard deviation) of 1,5 m/s².

The declared vibration total value has been measured in accordance with a standard test method and may be used for comparing on tool with another.

The declared vibration total value may also be used in a preliminary assessment of exposure.

Declaration of Conformity

EU Declaration of Conformity

We, **Husqvarna AB**, SE-561 82 Huskvarna, Sweden, tel: +46-36-146500, declare on our sole responsibility that the product:

Description	Battery-operated Hedge Trimmer
Brand	Husqvarna
Type / Model	520iHD60, 520iHD70
Identification	Serial numbers dating from 2023 and onwards

complies fully with the following EU directives and regulations:

Directive/Regulation	Description
2006/42/EC	"relating to machinery"
2014/30/EMC	"relating to electromagnetic compatibility"
2011/65/EU	"relating to restriction of hazardous substances"
2000/14/EC	"relating to outdoor noise"

and that the following standards and/or technical specifications are applied: EN 60745-1:2009+A11:2010, EN 60745-2-15:2009+A1:2010, EN 55014-1:2017+A11:2020, EN 55014-2:1997+A2:2008, EN IEC 63000:2018.



0404, SMP Svensk Maskinprovning AB, Box 4053, SE-904 03 Umeå, Sweden has carried out EC type examination in accordance with the machinery directive's (2006/42/EC) article 12, clause 3b.

0404, SMP Svensk Maskinprovning AB, has also verified agreement with annex V of the council's directive 2000/14/EC. Certificate No 01/094/024.

For information relating to noise emission, refer to *Technical data on page 15*.

Huskvarna, 2023-07-01.

Two handwritten signatures in black ink. The first signature is 'Stefan Holmberg' and the second is a more stylized signature, likely of the same person or another authorized representative.

Stefan Holmberg, R&D Director, Technology Management, Husqvarna AB.

Responsible for technical documentation.

UK Declaration of Conformity

We, **Husqvarna AB**, SE-561 82 Huskvarna, Sweden, tel: +46-36-146500, declare on our sole responsibility that the product:

Description	Battery-operated Hedge Trimmer
Brand	Husqvarna
Type / Model	520iHD60, 520iHD70
Identification	Serial numbers dating from 2023 and onwards

complies fully with the following UK regulations:

Description
The Supply of Machinery (Safety) Regulations 2008
Electromagnetic Compatibility Regulations 2016
The Restriction of the Use of Certain Hazardous Substances in Electrical and Electronic Equipment Regulations 2012
The Noise Emission in the Environment by Equipment for use Outdoors Regulations 2001

and that the following standards and/or technical specifications are applied: EN 60745-1:2009+A11:2010, EN 60745-2-15:2009+A1:2010, EN 55014-1:2017 +A11:2020, EN 55014-2:1997+A2:2008, EN IEC 63000:2018.

The Swedish Machinery Testing Institute, Sweden, has also verified agreement with the statutory instrument S.I. 2001/1701, conformity assessment procedure: Schedule 8.

Huskvarna, 2023-07-01.

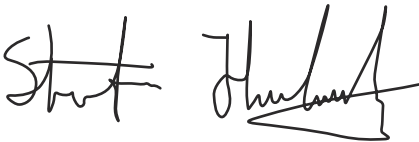

Stefan Holmberg, R&D Director, Technology Management, Husqvarna AB.

Responsible for technical documentation.

**UK
CA**

UK Importer:
Husqvarna UK Ltd
Preston Road, Co. Durham
DL5 6UP



www.husqvarna.com

Original instructions



1143402-26



2023-09-19