

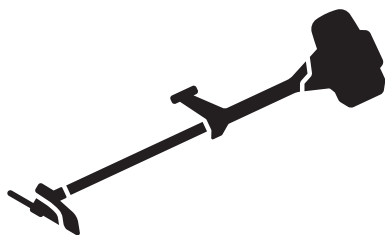

Husqvarna[®]



535RJ

Contents

Introduction.....	2	Transportation, storage and disposal.....	22
Safety.....	5	Technical data.....	23
Assembly.....	12	Accessories	24
Operation.....	14	Declaration of Conformity.....	25
Maintenance.....	18	Appendix	27
Troubleshooting.....	21		

Introduction

Product description

This product is a brushcutter with a combustion engine.

Work is constantly in progress to increase your safety and efficiency during operation. Speak to your servicing dealer for more information.

Intended use

Use the product with a grass blade or a trimmer head to cut grass. Do not use the product for other tasks than grass trimming and grass clearing.

Note: National or local regulations can set limit to the operation of the product.

Only use the product with accessories that are approved by the manufacturer. Refer to *Accessories on page 24*.

Product overview

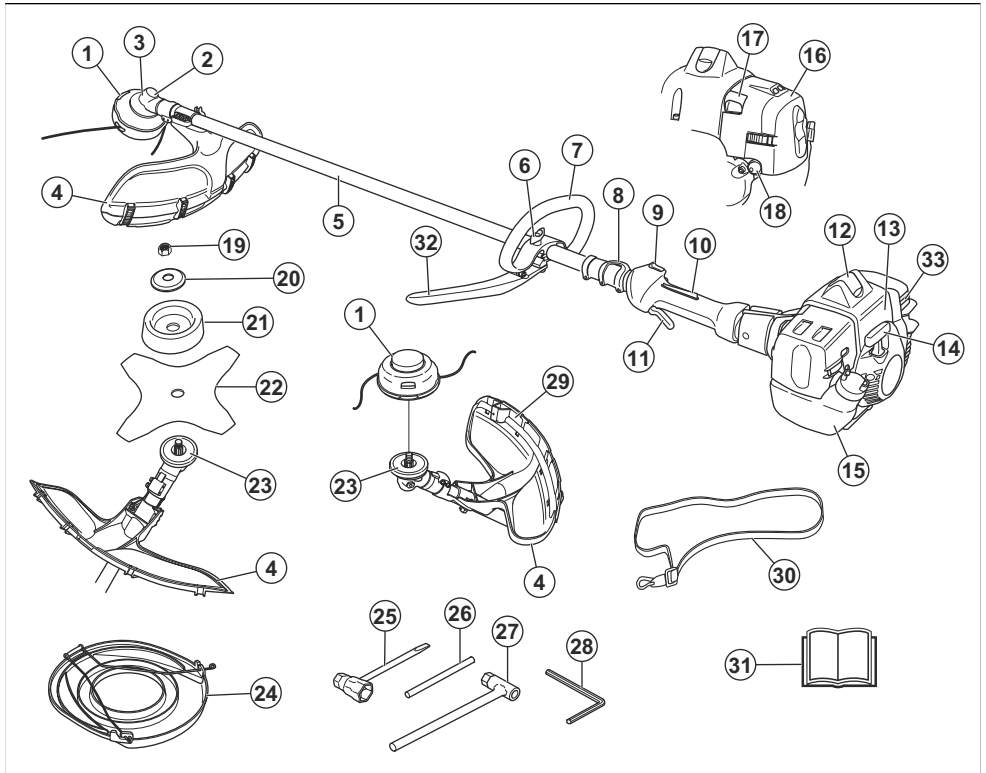

1. Trimmer head
2. Grease filler cap, bevel gear
3. Bevel gear
4. Cutting attachment guard
5. Shaft
6. Handle adjustment
7. Loop handle
8. Suspension ring
9. Stop switch
10. Throttle trigger lockout
11. Throttle trigger
12. Spark plug cap and spark plug
13. Cylinder cover
14. Starter rope handle
15. Fuel tank
16. Air filter cover
17. Choke control
18. Air purge bulb
19. Locknut
20. Support flange

21. Support cup
22. Blade
23. Drive disc
24. Transport guard
25. Socket wrench
26. Locking pin
27. Socket spanner
28. Hex key
29. Guard extension
30. Harness
31. Operator's manual
32. J-handle
33. Muffler

Symbols on the product



WARNING: This product can be dangerous and cause serious injury or death to the operator or others. Be careful and use the product correctly.



Read the operator's manual carefully and make sure that you understand the instructions before use.



Use a protective helmet in locations where objects can fall on you. Use approved hearing protection and approved eye protection.



Maximum speed of the output shaft.



The product agrees with the applicable EC directives.



This product conforms to the applicable UK regulations.



The product can cause objects to eject, which can cause injury.



Keep a minimum distance of 15 m / 50 ft. to persons and animals during operation of the product.



Risk of blade thrust if the cutting equipment touches an object that it does not immediately cut. The product can cut off body parts. Keep a minimum of 15 m / 50 ft. distance to persons and animals during operation of the product.



The arrows shows the limit for the handle position.



Choke.



Air purge bulb.



Only use a flexible cutting wire. Do not use metal cutting attachments. Apply this for grass guard accessory.



Use approved protective gloves.



Use heavy-duty slip-resistant boots.



Noise emissions to the environment label as per EU and UK directives and regulations, and New South Wales legislation "Protection of Environment Operations (Noise Control) Regulation 2017". The guaranteed sound power level of the product is specified in *Technical data on page 23*.

yyyywwxxxx

The rating plate or the laser printing shows the serial number. **yyyy** is the production year and **ww** is the production week.

Note: Other symbols/decals on the product refer to certification requirements for other commercial areas.

Euro V Emissions



WARNING: Tampering with the engine voids the EU type-approval of this product.

Product damage

We are not responsible for damages to our product if:

- the product is incorrectly repaired.
- the product is repaired with parts that are not from the manufacturer or not approved by the manufacturer.
- the product has an accessory that is not from the manufacturer or not approved by the manufacturer.
- the product is not repaired at an approved service center or by an approved authority.

Safety

Safety definitions

Warnings, cautions and notes are used to point out specially important parts of the manual.



WARNING: Used if there is a risk of injury or death for the operator or bystanders if the instructions in the manual are not obeyed.



CAUTION: Used if there is a risk of damage to the product, other materials or the adjacent area if the instructions in the manual are not obeyed.

Note: Used to give more information that is necessary in a given situation.

General safety instructions



WARNING: Read the warning instructions that follow before you use the product.

- Do not do changes to the product without approval from the manufacturer and always use original accessories. Not approved modifications and/or accessories can result in serious injury or the death of the operator or others.
- The inner side of the muffler contains chemicals that may be carcinogenic. Do not touch the muffler if it is damaged.
- A used muffler/spark arrester and spark arrester mounting face may contain deposits of combustion particles that may be carcinogenic. Avoid being exposed to these compounds when handling the muffler and/or spark arrester. Prior to any handling of the muffler and/or the spark arrester, refer to *To do a check of the muffler on page 9*.
- This product produces an electromagnetic field during operation, which can cause interference with medical implants. This can cause serious injury or death. Speak to your physician and the medical implant manufacturer before use.
- Do not touch the spark plug or spark plug cord when the engine is on. Risk of electrical shock.
- Your warranty may not be approved for damages caused by accessories or spare parts that are not approved.

Safety instructions for assembly



WARNING: Read the warning instructions that follow before you use the product.

- Remove the spark plug cap from the spark plug before you assemble the product.
- Use approved protective gloves.
- Make sure that you assemble the cover and shaft correctly before you start the engine.
- The drive disc and support flange must engage correctly in the center hole of the cutting attachment. A cutting attachment that is attached incorrectly can cause serious injury or death of the operator or others.
- To operate the product safely and prevent injury to the operator or other persons, the product must always be attached correctly to the harness.

Safety instructions for operation



WARNING: Read the warning instructions that follow before you use the product.

- You must understand the difference between grass clearing and grass trimming before use.
- If you encounter a situation where you are uncertain how to proceed you should ask an expert. Contact your dealer or your service workshop. Avoid all usage which you consider to be beyond your capability.
- Never use a product that is faulty. Carry out the safety checks, maintenance and service instructions described in this manual. Some maintenance and service measures must be carried out by trained and qualified specialists. Refer to *Maintenance on page 18*.
- All covers, guards and handles must be fitted before you start the product. Ensure that the spark plug cap and ignition lead are undamaged to avoid the risk of electric shock.
- Never use the product if you are fatigued, while under the influence of alcohol or drugs, medication or anything that could affect your vision, alertness, coordination or judgement.
- Do not use the product in bad weather such as dense fog, heavy rain, strong wind, intense cold, etcetera. Working in bad weather is tiring and often brings added risks, such as icy ground, unpredictable felling direction, etcetera.
- The only accessories you can operate with this engine unit are the cutting attachments that we recommend in the chapter *Accessories on page 24*.

- Never allow children to use or be in the vicinity of the product. As the product is equipped with a spring-loaded start/stop switch and can be started by low speed and force on the starter handle, even small children under some circumstances can produce the force necessary to start the product. This can mean a risk of serious personal injury. Therefore remove the spark plug cap when the product is not under close supervision.
- Running an engine in a confined or badly ventilated area can result in death due to asphyxiation or carbon monoxide poisoning.
- The complete clutch cover and shaft must be fitted before the product is started, otherwise the clutch can come loose and cause personal injury.
- Ensure that no people or animals come closer than 15 meters while you work. When several operators are working in the same area the safety distance should be at least 15 meters. Otherwise there is a risk of serious personal injury. Stop the product immediately if anyone approaches. Never swing the product around without first checking behind you to make sure that no one is within the safety zone.
- Ensure that people, animals or other things can not affect your control of the product or that they do not come in contact with the cutting attachment or loose objects that are thrown out by the cutting attachment. However, do not use the product unless you are able to call for help in the event of an accident.
- Always inspect the working area. Avoid all loose objects such as stones, broken glass, nails, steel wire, string, etcetera, that could be thrown out or become wrapped around the cutting attachment.
- Make sure that you can move and stand safely. Check the area around you for possible obstacles (roots, rocks, branches, ditches, etcetera) in case you have to move suddenly. Take great care when you work on sloping ground.



- Keep the cutting attachment below waist level.
- Switch off the engine before you move to an other area. Install the transportation guard before you carry or transport the equipment any distance.
- Never put the product down with the engine running unless you have it in clear sight.
- Stop the engine and cutting equipment before you remove material that has wound around the blade shaft. Neither the operator of the product nor anyone else may attempt to remove the cut material while the engine is running or the cutting equipment is rotating, as this can result in serious injury. The bevel gear can get hot during use and may remain so for a while afterwards. You could get burnt if you touch it.
- Watch out for thrown objects. Always wear approved eye protection. Never lean over the cutting attachment guard. Stones, rubbish, etcetera, can be thrown up into the eyes which can cause blindness or serious injury.
- Sometimes branches or grass get caught between the guard and cutting attachment. Always stop the engine before you clean the product.
- Products that are fitted with saw blades or grass blades can be thrown violently to the side when the blade comes into contact with a fixed object. This is called blade thrust. A blade thrust can be violent enough to cause the product and/or operator to be propelled in any direction, and possibly lose control of the product. Blade thrust can occur without warning if the product snags, stalls or binds. Blade thrust is more likely to occur in areas where it is difficult to see the material being cut.
- Avoid to cut with the area of the blade between the 12 o'clock and 3 o'clock positions. Because of the speed of rotation of the blade, blade thrust can occur if you attempt to cut thick stems with this area of the blade.
- Always slow the engine to idle speed after each working operation. Long periods at full throttle

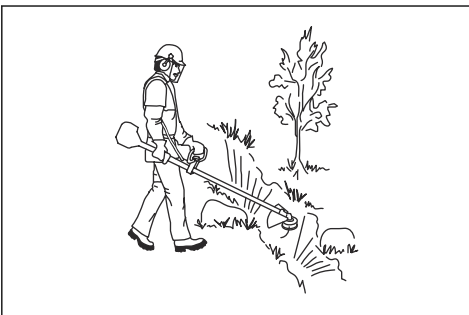

- Keep a good balance and a firm foothold at all times. Do not overreach.
- Always hold the product with both hands. Hold the product on the right side of your body.
 - Use the harness and make sure that you attach it to the suspension ring.

without any load on the engine can lead to serious engine damage.

- Listen out for warning signals or shouts when you wear hearing protection. Always remove your hearing protection as soon as the engine stops.
- Overexposure to vibration can lead to circulatory damage or nerve damage in people who have impaired circulation. Contact your doctor if you experience symptoms of overexposure to vibration. These symptoms include numbness, loss of feeling, tingling, pricking, pain, loss of strength, changes in skin color or condition. These symptoms normally appear in the fingers, hands or wrists.
- Do not use a product with a damaged spark plug cap.
- Do not use a product with a damaged muffler.
- Keep all parts of your body away from the rotating cutting equipment and hot surfaces.
- Always wear protective gloves when you touch the grass blade.

Personal protective equipment



WARNING: Read the warning instructions that follow before you use the product.

- Always use approved personal protective equipment when you use the product. Personal protective equipment cannot fully prevent injury but it decreases the degree of injury if an accident does occur. Let your dealer help you select the right equipment.
- Use a protective helmet where there is a risk of falling objects.
- Use approved hearing protection that provides adequate noise reduction. Long-term exposure to noise can result in permanent hearing impairment.
- Use approved eye protection. If you use a visor, you must also use approved protective goggles. Approved protective goggles must comply with the ANSI Z87.1 standard in the USA or EN 166 in EU countries.
- Use a visor for face protection. A visor is not enough for protection of the eyes.



- Use gloves when necessary, for example when you attach, examine or clean the cutting equipment.
- Use sturdy non-slip boots.
- Use clothing made of a strong fabric. Always use heavy, long pants and long sleeves. Do not use loose clothing that can catch on twigs and branches. Do not wear jewelry, short pants, sandals or go with

bare feet. Put your hair up safely above shoulder level.



- Keep first aid equipment close at hand.



Safety devices on the product

For information about where to find the safety devices, see *Product overview on page 3*.



WARNING: Read the warning instructions that follow before you use the product.

- Do not use a product with damaged safety devices. Do a check of and do maintenance on the safety devices regularly. If the safety devices are damaged, speak to your Husqvarna service agent.
- Do not make changes to safety devices. Do not use the product if protective covers, safety switches or other protective devices are not attached or are damaged.
- For all service and repair work on the product, especially for the safety devices, special training is necessary. If the safety devices fail the checks given in this operator's manual, you must let a service agent help you. We guarantee that professional repairs and service is available. If your dealer is not a service agent, speak to them for information about the nearest service agent.
- Do not use a cutting attachment without an approved and correctly attached cutting attachment guard. See *To install the cutting attachment guard and the grass blade on page 12*.

To do a check of the throttle trigger lockout

The throttle trigger lockout prevents accidental operation of the throttle control.

1. Push the throttle trigger lockout (A) and make sure that the throttle control is released (B).

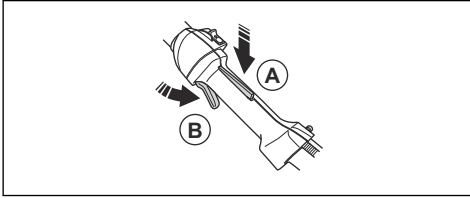

2. Release the throttle trigger lockout and make sure that the throttle control is locked at idle speed.

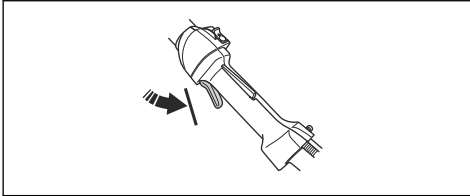

3. Push the throttle trigger lockout and make sure that it returns to its initial position when you release it.

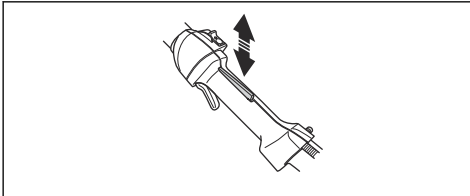

4. Make sure that the throttle control and throttle trigger lockout move freely and that the return springs operate correctly.

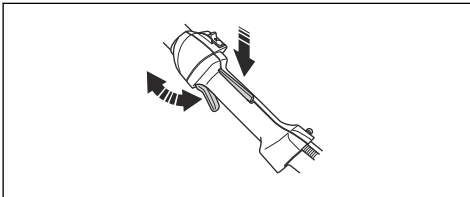

5. Start the product and apply full throttle. Refer to *To start the product on page 16*.
6. Release the throttle control and make sure that the cutting attachment stops. If the cutting attachment rotates with the throttle in the idle position, do a check of the carburetor adjustments. Refer to *To adjust the idle speed on page 19*.

To do a check of the stop switch

1. Start the engine.

2. Move the stop switch to the stop position and make sure that the engine stops.

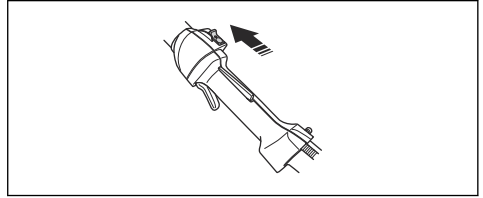

To do a check of the cutting attachment guard



WARNING: Do not use a cutting attachment without an approved and correctly attached cutting attachment guard. See *To install the cutting attachment guard and the grass blade on page 12*.



WARNING: Always use the recommended cutting attachment guard for the cutting attachment that you use. If an incorrect or faulty cutting attachment guard is fitted this can cause serious personal injury. See instructions under heading *To install the cutting attachment guard and the grass blade on page 12*.

The cutting attachment guard prevents injuries from objects that eject in the direction of the operator.

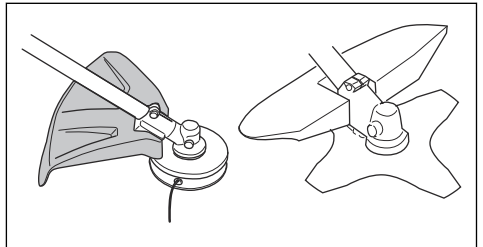

1. Make sure that the cutting attachment guard is not damaged or cracked.
2. Replace the guard if it has been exposed to impact or is cracked.

To do a check of the vibration damping system

Note: Use of incorrectly wound cord or an incorrect cutting attachment increases the level of vibration. See instructions under *Assembly on page 12*.

The vibration damping system decreases vibration in the handles to a minimum which makes the operation easier. The vibration damping system of the product

decreases the transfer of vibration between the engine unit and the shaft unit of the product.

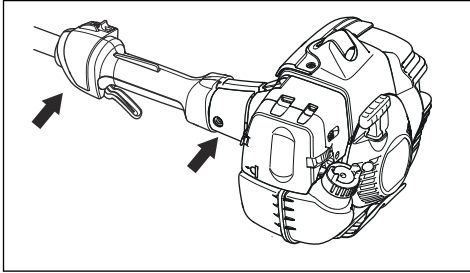

1. Stop the engine.
2. Do a visual check for deformation and damage for example, cracks.
3. Make sure you attach the elements of the vibration damping system correctly.

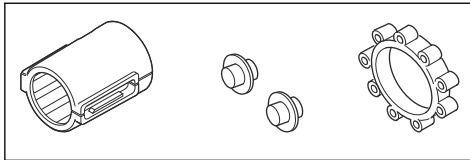

To do a check of the muffler



WARNING: A used muffler/spark arrester and spark arrester mounting face may contain deposits of combustion particles on the surfaces that may be carcinogenic. To avoid skin contact and inhalation of such particles when cleaning and/or servicing the spark arrester, make sure you always:

- wear gloves;
- clean and/or service in a well ventilated area;
- do not use pressurized air to clean the spark arrester screen;
- use a steel brush and brush away from your body when cleaning the spark arrester.



WARNING: Do not use a product that has a damaged muffler or a muffler that is in bad condition. Return the product to a Husqvarna dealer/service station if the muffler is damaged.



WARNING: Do not use the product if the spark arrester screen on the muffler is missing or damaged.



WARNING: The muffler becomes very hot during and after operation and also at idle speed. Use protective gloves to prevent burn injuries.

The muffler keeps noise levels to a minimum and points exhaust fumes away from the operator.

1. Stop the engine.
2. Do a visual check for damage and deformation.

Note: The inner surfaces of the muffler contain chemicals that can cause cancer. Be careful not to touch these elements if the muffler is damaged.

3. Make sure that the muffler is correctly attached to the product.

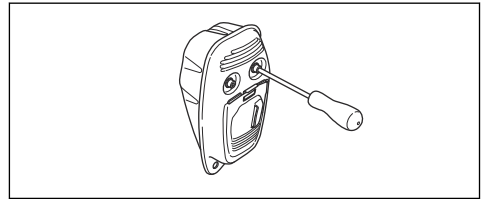

Note: Do not remove the muffler from the product.

4. If the muffler on your product has a spark arrester screen, do a visual check.

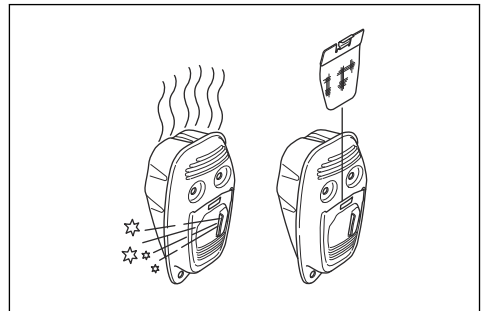

- a) Replace the spark arrester screen if it is damaged.
- b) Clean the spark arrester screen if it is blocked. Refer to *To clean the muffler on page 19* for more information.



CAUTION: If the spark arrester screen is blocked the product becomes too hot and this causes damage to the cylinder and piston.

To attach and remove the locknut



WARNING: Stop the engine, use protective gloves and be careful around the sharp edges of the cutting attachment.

A locknut is used to attach some types of cutting attachments. The locknut has a left thread.

- To attach, tighten the locknut in the opposite direction to the direction of turning of the cutting attachment.
- To remove the locknut, loosen the locknut in the same direction as the cutting attachment rotates.
- To loosen and tighten the locknut, use a socket wrench with a long shaft. The arrow in the picture shows the area where you can operate the socket wrench.

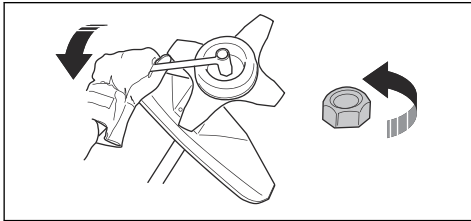

WARNING: When you loosen and tighten the locknut, there is a risk of injury from the blade. You must always make sure that the blade guard prevents injury to your hand when you do this.

Note: Make sure that you can not turn the locknut by hand. Replace the nut if the nylon lining does not have a resistance of a minimum of 1.5 Nm. The locknut must be replaced after it has been put on approximately 10 times.

Cutting equipment

- Use the blades and grass knives to cut coarse grass.

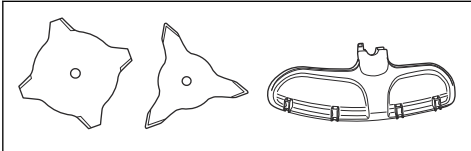

- Use the trimmer head to cut grass.

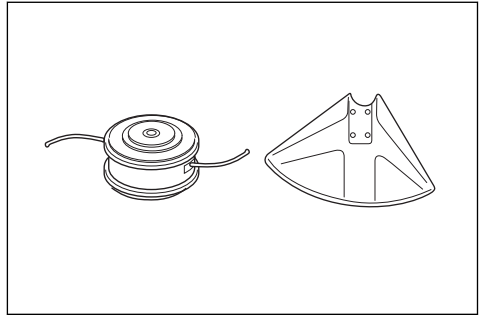

- An incorrectly sharpened or damaged blade increases the risk of accidents. Keep the teeth of the blade correctly sharpened. Follow the instructions in *To sharpen the grass knife and grass blade on page 21* and use the recommended file gauge.

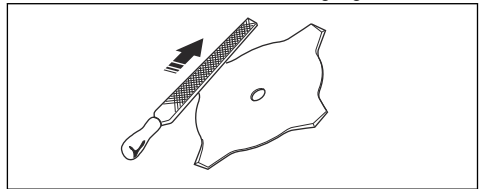

- Examine the cutting attachment for damage and cracks. Replace damaged cutting attachment.
- Only use cutting attachments with recommended cutting attachment guards. Refer to *Accessories on page 24*.

Trimmer head



WARNING: Always make sure that the trimmer line is wound tightly and equally around the drum to prevent harmful vibration.

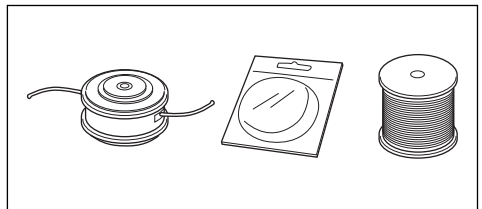

- Only use recommended cutting attachments.
- The length of the trimmer line is important. For a longer trimmer line, more engine power is necessary than for a shorter trimmer line of the same diameter.
- Do not move the installation position of the trimmer guard.
- Make sure that the cutter on the trimmer guard is not damaged. The cutter cuts the trimmer line to the correct length.

- Soak the trimmer line for 2 days before use, to increase its life length.

Blade thrust

- A blade thrust is a sudden movement of the product to the side, forward or rearward. A blade thrust occurs when the grass blade hits an object that cannot be cut. In areas where it is not easy to see the material being cut the risk of blade thrust increases.
- When a blade thrust occurs, there is a risk that the product or the operator moves out of position. A blade that moves can hit bystanders and there is a risk of injuries.
- If a blade is bent, has cracks, is broken or damaged, discard the blade.
- Use a sharp blade. The risk of blade thrust increases when a blade is not sharp.

Fuel safety



WARNING: Read the warning instructions that follow before you use the product.

- Do not mix the fuel indoor or near a heat source.
- Do not start the product if there is fuel or engine oil on the product. Remove the unwanted fuel/oil and let the product dry. Remove unwanted fuel from the product.
- If you spill fuel on your clothing, change clothing immediately.
- Do not get fuel on your body, it can cause injury. If you get fuel on your body, use a soap and water to remove the fuel.
- Do not start the engine if you spill oil or fuel on the product or on your body.
- Do not start the product if the engine has a leak. Examine the engine for leaks regularly.
- Be careful with fuel. Fuel is flammable and the fumes are explosive and can cause injuries or death.
- Do not breathe in the fuel fumes, it can cause injury. Make sure that there is sufficient airflow.
- Do not smoke near the fuel or the engine.
- Do not put warm objects near the fuel or the engine.
- Do not add the fuel when the engine is on.
- Make sure that the engine is cool before you refuel.
- Before you refuel, open the fuel tank cap slowly and release the pressure carefully.
- Make sure there are sufficient airflow when refueling and mixing fuel (petrol and two-stroke oil) or draining the fuel tank.
- Fuel and fuel vapor are highly flammable and can cause serious injury when inhaled or allowed to

come into contact with the skin. For this reason, observe caution when handling fuel and make sure there is sufficient airflow.

- Tighten the fuel tank cap carefully or a fire can occur.
- Move the product at a minimum of 3 m (10 ft) from the position where you filled the tank before a start.
- Do not put too much fuel in the fuel tank.
- Make sure that a leak cannot occur when you move the product or fuel container.
- Do not put the product or a fuel container where there is an open flame, spark or pilot light. Make sure that the storage area does not contain an open flame.
- Only use approved containers when you move the fuel or put the fuel into storage.
- Empty the fuel tank before long-term storage. Obey the local law on where to dispose fuel.
- Clean the product before long-term storage.
- Remove the spark plug cap before you put the product into storage to make sure that the engine does not start accidentally.

Safety instructions for maintenance



WARNING: Read the warning instructions that follow before you use the product.

- Stop the engine, make sure that the cutting attachment stops and let the product cool down before you do the maintenance.
- Disconnect the spark plug cap before you do the maintenance.
- The exhaust fumes from the engine contain carbon monoxide, an odorless, poisonous and very dangerous gas that can cause death. Do not run the product indoors or in closed spaces.
- The exhaust fumes from the engine are hot and can contain sparks. Do not run the product indoors or near flammable material.
- Accessories and changes to the product that are not approved by the manufacturer, can cause serious injury or death. Do not change the product. Always use original accessories.
- If the maintenance is not done correctly and regularly, there is an increased risk of injury and damage to the product.
- Only do the maintenance as this operator's manual recommends. Let an approved Husqvarna service agent do all other servicing.
- Let an approved Husqvarna service agent do servicing on the product regularly.
- Replace damaged, worn or broken parts.

Assembly

Introduction



WARNING: Read and understand the safety chapter before you assemble the product.

To assemble the loop handle

1. Put the loop handle on the shaft below the arrow.

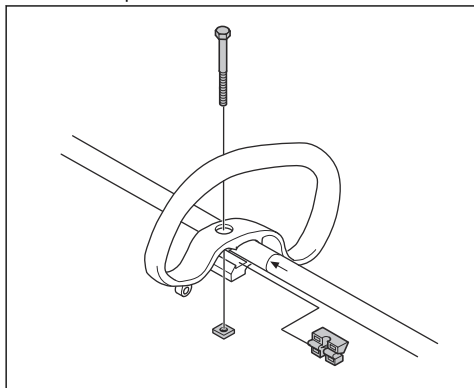

2. Install the spacer into the slot of the loop handle.
3. Install the nut and the screw. Do not tighten too much.
4. Adjust the product to a correct work position.
5. Tighten the screw.

To assemble the J-handle



WARNING: Do not use saw blades with the J-handle.

1. Attach the J-handle to the loop handle with the 3 screws.

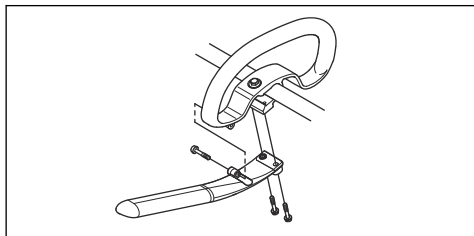

2. Adjust the product to a correct work position.

3. Tighten the screws.

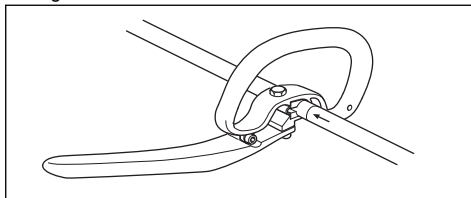

To install the cutting attachment guard and the grass blade

1. Put the cutting attachment guard (A) onto the shaft and tighten the bolt.

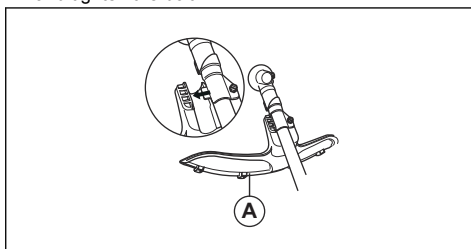

2. Turn the output shaft to align one of the holes in the drive disc (B) with the related hole in the gear housing.
3. Put the locking pin (C) in the hole to lock the shaft.
4. Put the grass blade (D), the support cup (E) and the support flange (F) on the output shaft.

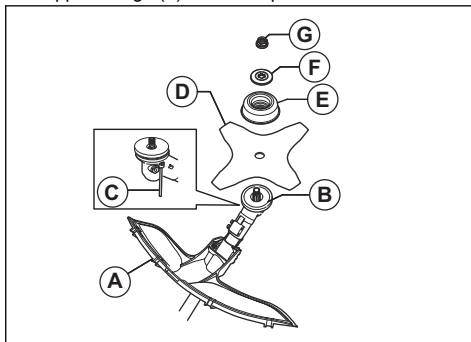

5. Make sure that the drive disc and support flange engages correctly in the center hole of the grass blade.

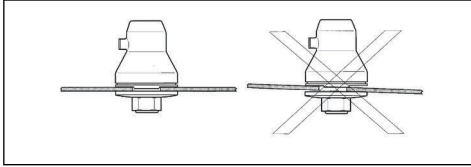

6. Attach the nut (G).
7. Tighten the nut with the socket wrench. Hold the shaft of the socket wrench near the cutting attachment guard. Tighten in the opposite direction to how the cutting attachment rotates. Torque the nut to 35–50 Nm.

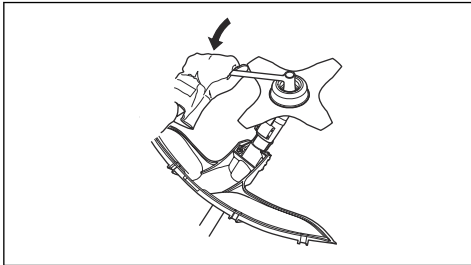

To install the cutting attachment guard and the trimmer head



CAUTION: Make sure that the guard extension is assembled.

1. Install the cutting attachment guard (A) intended for operation with the trimmer head.
2. Hang the cutting attachment guard on the 2 hooks on the plate holder (B).
3. Bend the cutting attachment guard around the shaft and tighten the screw (C) on the opposite side of the shaft. Use the combination wrench to tighten the screw.

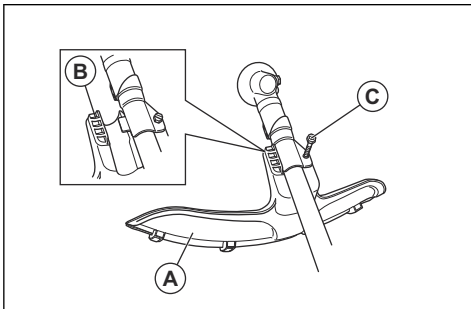

4. Install the drive disc (D) on the output shaft.

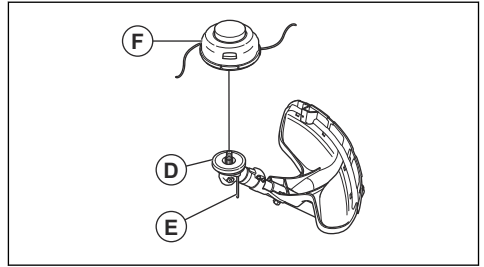

5. Turn the output shaft until 1 of the holes in the drive disc aligns with the related hole in the gear housing.
6. Put the locking pin (E) in the hole to lock the shaft.
7. Install the trimmer head (F) counterclockwise.

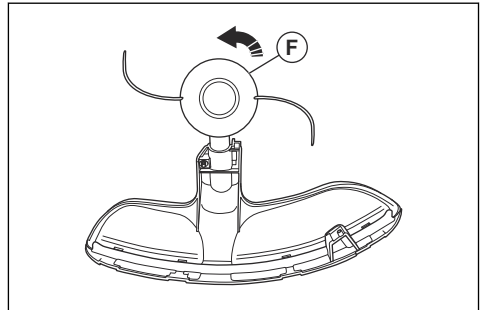

8. To remove the trimmer head and the cutting attachment guard, follow the instructions in the opposite sequence.

To install the transport guard

1. Put the blade in the transport guard (A).
2. Put the 2 fasteners (B) into the slots (C) to attach the transport guard.

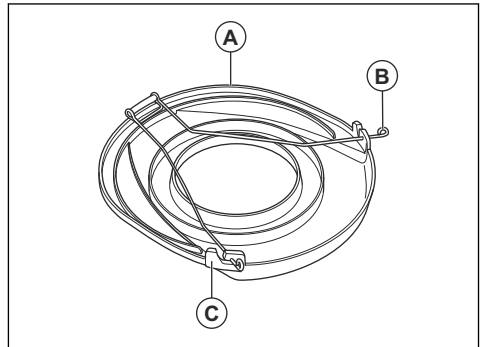

Operation

Introduction



WARNING: Read and understand the safety chapter before you use the product.

Fuel

This product has a two-stroke engine.



CAUTION: Incorrect type of fuel can result in engine damage. Use a mixture of gasoline and two-stroke oil.

Premixed fuel

- Use Husqvarna premixed alkylate fuel for best performance and extension of the engine life. This fuel contains less harmful chemicals compared to regular fuel, which decreases harmful exhaust fumes. The quantity of remains after combustion is lower with this fuel, which keeps the components of the engine more clean.

To mix fuel

Gasoline

- Use good quality unleaded gasoline with a maximum of 10% ethanol contents.



CAUTION: Do not use gasoline with an octane grade less than 90 RON/87 AKI. Use of a lower octane grade can cause engine knocking, which causes engine damages.

Two-stroke oil

- For best results and performance use Husqvarna two-stroke oil.
- If Husqvarna two-stroke oil is not available, use a two-stroke oil of good quality for air-cooled engines. Speak to your servicing dealer to select the correct oil.



CAUTION: Do not use two-stroke oil for water-cooled outboard engines, also referred to as outboard oil. Do not use oil for four-stroke engines.

To mix gasoline and two-stroke oil

Gasoline, liter	Two-stroke oil, liter
	2% (50:1)

5	0.10
10	0.20
15	0.30
20	0.40



CAUTION: Small errors can influence the ratio of the mixture drastically when you mix small quantities of fuel. Measure the quantity of oil carefully and make sure that you get the correct mixture.

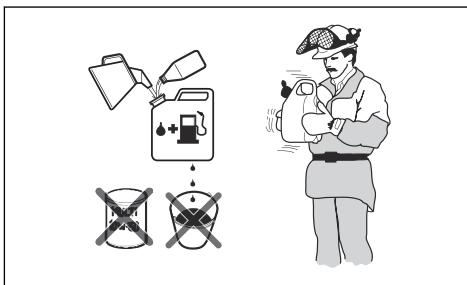

- Fill half the quantity of gasoline in a clean container for fuel.
- Add the full quantity of oil.
- Shake the fuel mixture.
- Add the remaining quantity of gasoline to the container.
- Carefully shake the fuel mixture.



CAUTION: Do not mix fuel for more than 1 month at a time.

To fill the fuel tank

- Clean the area around the fuel tank cap.
- Shake the container and make sure that the fuel is fully mixed. Use a fuel container with an anti-spill valve.
- Fill the fuel tank.
- Tighten the fuel tank cap carefully.
- Move the product 3 m (10 ft) or more away from the refueling area and fuel source before starting.

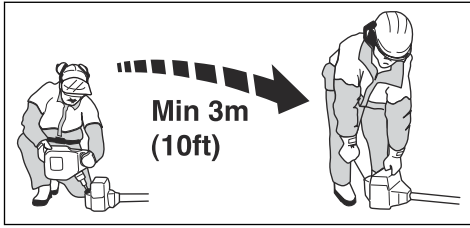

CAUTION: Contamination in the tanks causes malfunction. Clean the fuel tank and chain oil tank regularly and replace the fuel filter one time a year or more.

To examine the product before operation

- Examine the motor for dirt and cracks. Use a brush to remove grass and leaves from the engine. Wear protective gloves when necessary.
- Make sure that the trimmer head is fully attached to the product.
- Do the safety inspections, maintenance and servicing that are given in this manual.
- Make sure that the product is not damaged. Examine that all nuts and screws are tight.
- Make sure that there are no cracks on the blade. Cracks usually occur when you make too sharp corners at the bottom of the teeth while you sharpen the blade. Cracks can also occur if you use the blade with blunt teeth. Replace the blade if it is damaged.

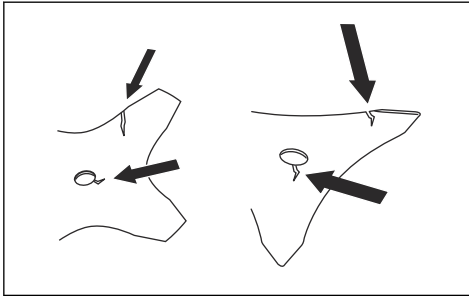

- Examine the support flange for cracks. Replace the support flange if it is damaged.

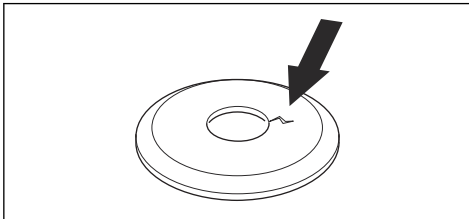

- Make sure that the locking force on the locknut is not decreased. The locknut must have a locking force at a minimum of 1.5 Nm. The tightening torque of the locknut must be between 35-50 Nm.

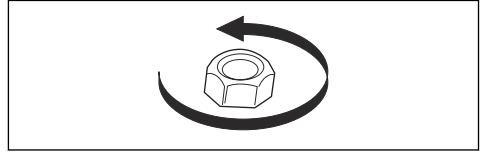

- Examine the blade guard for damages or cracks. Replace the blade guard if it has been hit or if it has cracks. Do not use the product without a guard or a damaged guard.
- Examine the trimmer head and cutting attachment guard for damages or cracks. Replace the trimmer head and cutting attachment guard if they have been hit or if they have cracks.

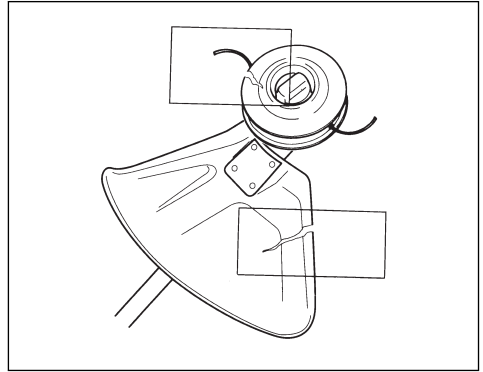

- Make sure that all covers, guards, handles and the cutting equipment are correctly attached and not damaged before you start the product.

To prepare the product for start

1. Press the air purge again and again until the fuel starts to fill the bulb.

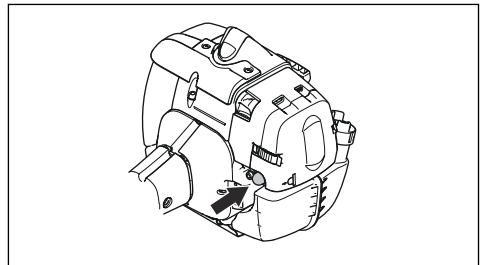

Note: It is not necessary to fully fill the bulb.

2. Move the choke control up into choke position.

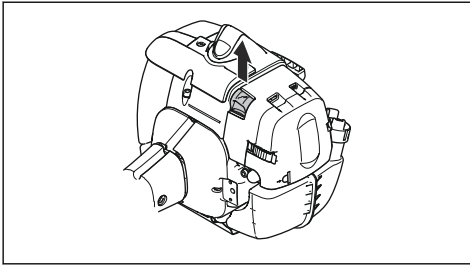

WARNING: The cutting attachment will start to rotate immediately when you start the engine with the choke.

To start the product



WARNING: Read the warning instructions in the safety chapter before you start the product (refer to *Safety on page 5*).

1. Use protective gloves.
2. Hold the body of the product on the ground with your left hand.



CAUTION: Do not use your feet!

3. Hold the starter rope handle with your right hand.
4. Slowly pull out the starter rope with your right hand until you feel some resistance (the starter pawls grip).



WARNING: Do not twist the starter rope around your hand.

5. Pull the cord quickly and with power.



CAUTION: Do not pull the starter rope all the way out and do not let go off the starter rope handle when the starter rope is fully extended. This can cause damage to the product.

6. Pull the starter rope until the engine starts or for a maximum of 5 times.
7. Reset the choke when the engine starts or after you pull the starter rope 5 times.
8. If it is necessary, pull the starter rope again and again until the engine starts.
9. Let the engine run for 10 seconds.
10. Operate the throttle gradually.
11. Make sure the engine runs smoothly.

Note: If the engine stops, do the procedure again.

About the surface



WARNING: Do not put parts of your body in the grey marked area. If you touch the grey marked area it can result in burns to the skin. It can also cause electrical shock if the spark plug cap has been damaged. Do not use a product with a damaged spark plug cap.

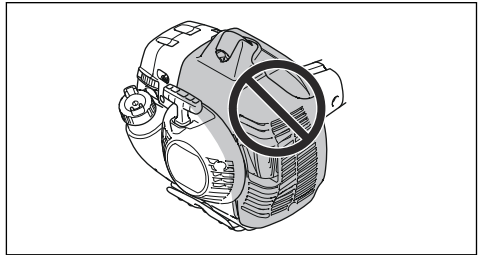

To stop the engine

- Move the stop switch to the stop position to stop the engine.

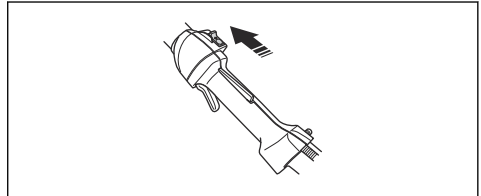

To clear grass with a grass blade



CAUTION: Do not use grass blades and grass knives on wood. Use grass blades and grass knives for long or heavy grass only.

1. Keep a stable position with your feet apart.
2. Keep the support cup with a light pressure against the ground to make sure that the grass blade does not hit the ground.
3. Start the movement from right to left when you cut. Move the product to the right before you cut again.

- Cut with the left side of the grass blade.

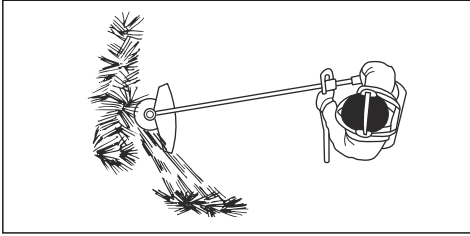

- Tilt the blade to the left to make the grass fall in a line. This makes it easy to collect the grass.
- Obey these instructions to decrease the risk that cut material winds around the grass blade:
 - Apply full throttle.
 - Do not move the grass blade through cut material when you move the product from left to right.
- Move forward after each right movement and make sure that you have a stable position again before you cut again.
- Before you collect the cut material, stop the engine and remove the product from the harness. Put the product down on the ground.

To trim grass with a trimmer head

To trim the grass

- Hold the trimmer head immediately above the ground at an angle. Do not push the trimmer line into the grass.

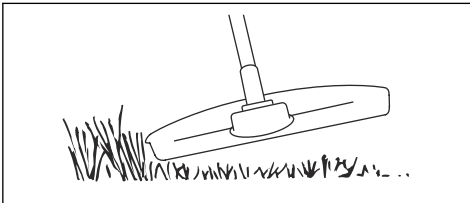

- Decrease the length of the trimmer line by 10-12 cm / 4-4.75 in.
- Decrease the engine speed to decrease the risk of damage to plants.
- Use 80 % throttle when you cut grass near objects.

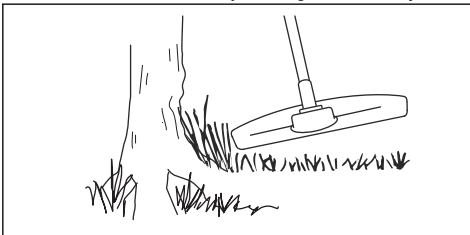

To clear grass

- Keep the trimmer head above the ground.
- Tilt the trimmer head.
- Cut with the end of the trimmer line around objects in the work area.



CAUTION: Cut grass. Other objects that are hit by the trimmer line, increases the wear on the trimmer line.

- Use 80% speed when you cut and clear vegetation. This decreases the wear on the trimmer head and trimmer line.

To cut the grass

- Make sure that the trimmer line is parallel to the ground when you cut.

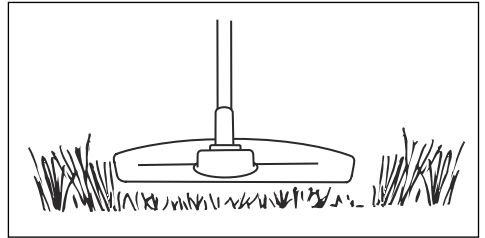

- Do not push the trimmer head to the ground. The ground and the product can be damaged.
- Do not let the trimmer head touch the ground continuously, it can cause damage to the trimmer head.
- Use full throttle when you move the product from side to side to cut grass.

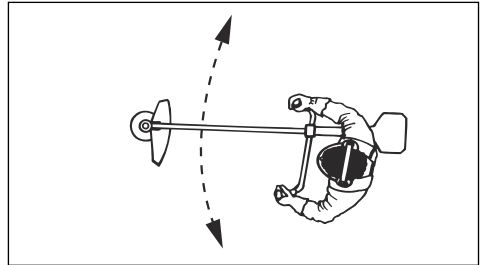

To sweep the grass

The airflow from the rotating trimmer line can be used to remove cut grass from an area.

- Hold the trimmer head and the trimmer line parallel to the ground and above the ground.
- Apply full throttle.
- Move the trimmer head from side to side and sweep the grass.



WARNING: Clean the trimmer head cover each time you assemble new trimmer line to prevent unbalance and vibrations in

the handles. Also do a check of the other parts of the trimmer head and clean it if necessary.

Maintenance

Introduction



WARNING: Read and understand the safety chapter before you do maintenance on the product.

Note: The user must only carry out the maintenance and service work described in this operator's manual. More extensive work must be carried out by an approved service workshop.

Maintenance schedule

The following is a list of the maintenance steps that must be performed on the product. Most of the items are described in *Maintenance on page 18*

Maintenance	Daily	Weekly	Monthly
Clean the external surface.	X		
Make sure that the throttle trigger lock and the throttle works correctly from a safety point of view.	X		
Do a check of the stop switch to make sure that it works correctly.	X		
Make sure that the cutting attachment does not rotate at idle speed.	X		
Clean the air filter. Replace if necessary.	X		
Examine the cutting attachment guard for damages and cracks. Replace the guard if it has been exposed to impact or is cracked.	X		
Examine the trimmer head for damages and cracks. Replace if damaged.	X		
Make sure that the screws and nuts are tight.	X		
Examine the engine, the fuel tank and the fuel lines for leaks.	X		
Clean the cooling system.		X	
Examine the starter and the starter rope for damages.		X	
Examine the vibration damping units for damages and cracks.		X	
Clean the outside of the spark plug. Remove it and do a check of the electrode gap. Adjust the gap to the correct distance (see, <i>Technical data on page 23</i>) or replace the spark plug. Make sure that the spark plug is fitted with a suppressor.		X	
Clean the outside of the carburetor and the space around it.		X	
Do a check of the bevel gear to make sure that it is filled three-quarters with lubricant. Use special grease to fill if necessary.		X	
Clean or replace the spark arrester screen on the muffler (only applies to mufflers without a catalytic converter).		X	
Do a check of the fuel filter for contamination and the fuel hose for cracks or other damages. Replace if necessary.			X
Do a check of all cables and connections.			X

Maintenance	Daily	Weekly	Monthly
Do a check of the clutch, clutch springs and the clutch drum for wear. Replace if necessary. Speak to an approved service workshop.			X
Replace the spark plug. Make sure that the spark plug is fitted with a suppressor.			X
Check and clean the spark arrester screen on the muffler (only applies to mufflers without a catalytic converter).			X

To adjust the idle speed

Your Husqvarna product is designed and made to specifications that decrease harmful emissions.

- Make sure that the air filter is clean and the air filter cover is attached before you adjust the idle speed.
- Adjust the idle speed with the idle adjustment screw T which is identified with "T" mark.



WARNING: If the cutting attachment does not stop when you adjust the idle speed, turn to your nearest servicing dealer. Do not use the product until it is correctly adjusted or repaired.

- The idle speed is correct when the engine operates smoothly in all positions. The idle speed must be below the speed when the cutting attachment starts to turn.
1. Turn the idle adjustment screw clockwise until the cutting attachment starts to turn.

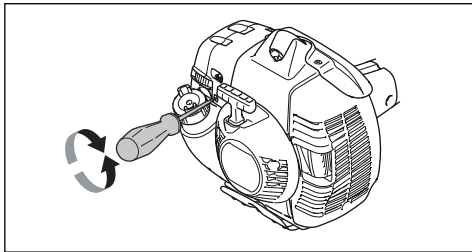

2. Turn the idle adjustment screw counterclockwise until the cutting attachment stops.

Note: See *Technical data on page 23* for the recommended idle speed.

To clean the muffler



WARNING: The muffler gets very hot during and after operation, also at idle speed. Risk of fire and burn injuries.



WARNING: Do not use the product if the muffler is missing or damaged. A muffler that is damaged or missing increases the noise level and the risk of fire. Keep fire extinguishing tools near. Do not use the product if the spark arrester screen is missing or damaged, if you must have a spark arrester screen in your area:

- use gloves;
- do maintenance in an area with a good airflow;
- do not use pressurized air to clean the spark arrester screen;
- use a steel brush and brush away from your body when you clean the spark arrester.

1. If the muffler on your product has a spark arrester screen, clean it weekly with a steel brush. Replace the spark arrester screen if it is damaged.

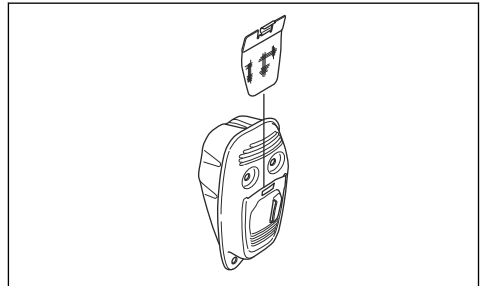

CAUTION: A blocked spark arrester screen causes the engine to become too hot and results in damage to the cylinder and piston.



CAUTION: If the spark arrester screen is frequently blocked, let your service agent examine the muffler.

To clean the air filter



CAUTION: A air filter that is damaged, very dirty or soaked with fuel must always be replaced.

If you use an air filter for a long time it cannot be fully cleaned. Replace the air filter with a new one at regular intervals.

1. Move the choke lever up, to close the choke valve.

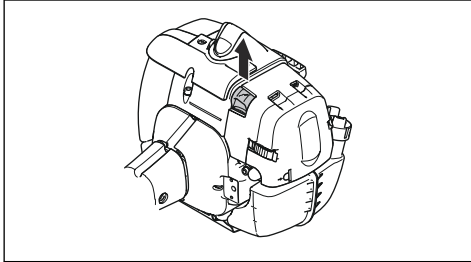

2. Remove the air filter cover and remove the air filter.

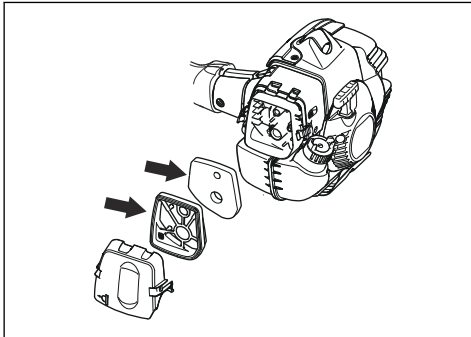

3. Clean the air filter with warm soap water. Make sure that the air filter is dry before you install it.
4. Replace the air filter if it is too dirty to fully clean it. Always replace a damaged air filter.
5. Also clean the inner surface of the filter cover. Use air or a brush.
6. Do a check of the rubber sealing surface. Replace the filter on the rubber seal if it is damaged.
7. Make sure that the filter is dry before you assemble it.

Air filter

Remove dust and dirt from the air filter to keep it clean and prevent these problems:

- Carburetor malfunctions.
- Problems when you start the product.
- Loss of engine power.
- Increased wear to engine parts.
- Too much fuel consumption.

To lubricate the bevel gear

1. Remove the cutting equipment.
2. Put the product with the grease plug at its highest position.
3. Remove the grease plug.

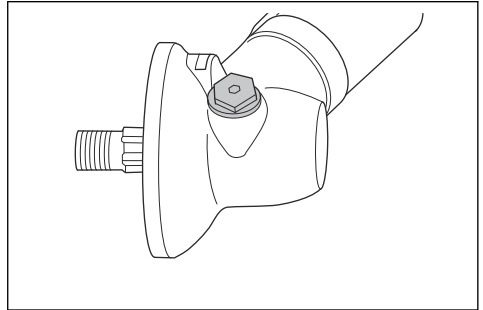

4. Look into the grease plug hole and turn the drive shaft. The grease level (A) must be in level with the top of the gear cogs (B).

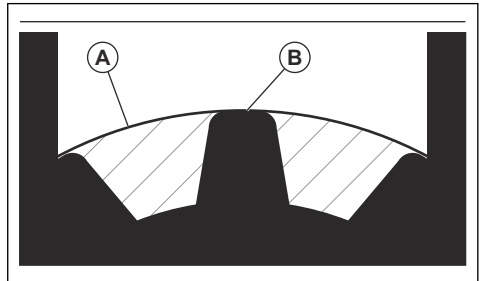

5. If the grease level is too low fill the bevel gear with Husqvarna bevel gear grease. Fill slowly and turn the drive shaft as you apply the bevel gear grease, stop at the correct level (B).



CAUTION: An incorrect quantity of grease can cause damage to the bevel gear.

6. Install the grease plug.

To do a check of the spark plug



CAUTION: Always use the recommended spark plug type. Incorrect spark plug type can cause damage to the product.

- Do a check of the spark plug if the engine is low on power, is not easy to start or does not operate correctly at idle speed.
- To decrease the risk of unwanted material on the spark plug electrodes, obey these instructions:

- a) Make sure that the idle speed is correctly adjusted.
- b) Make sure that the fuel mixture is correct.
- c) Make sure that the air filter is clean.
- If the spark plug is dirty, clean it and make sure that the electrode gap is correct, refer to *Technical data* on page 23.

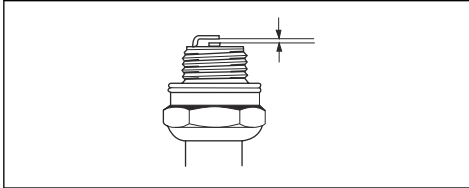

- Replace the spark plug if it is necessary.

- To sharpen the grass knife or grass blade correctly, refer to the instructions that come with the cutting attachment.
- Sharpen all edges equally to keep the balance.
- Use a single-cut flat file.

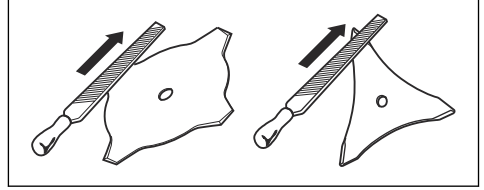

WARNING: Always discard a blade that is damaged. Do not try to make a bent or twisted blade straight and use it again.

To sharpen the grass knife and grass blade



WARNING: Stop the engine. Use protective gloves.

Troubleshooting

Starting failure		
Check	Possible cause	Solution
Stop button	Stop position	Set the stop switch to the start position.
Starter pawls	Binding pawls	Adjust or replace the pawls.
		Clean around the pawls.
		Speak to an approved servicing dealer.
Fuel tank	Incorrect fuel type.	Drain it and use correct fuel.
Carburetor	Adjustment of the idle speed.	Adjust the idle speed with the T screw.
Spark (no spark)	Spark plug dirty or wet.	Make sure that the spark plug is dry and clean.
	Spark plug clearance incorrect.	Clean the spark plug. Check that the electrode gap is correct. Make sure that the spark plug is installed with a suppressor.
		Refer to technical data for correct electrode gap.
Spark plug	Spark plug loose.	Tighten the spark plug.
Fuel filter	Clogged fuel filter.	Replace the fuel filter.

Engine starts but does not stay running		
Check	Possible cause	Solution
Fuel tank	Incorrect fuel type.	Drain it and use correct fuel.
Carburetor	Engine will not idle correctly.	Speak to your servicing dealer.
Air filter	Clogged air filter.	Clean the air filter.
Fuel filter	Clogged fuel filter.	Replace the fuel filter.

Transportation, storage and disposal

Transportation and storage

- Let the product cool before transportation or storage.
- Remove the spark plug cap before long-term storage.
- Attach the product during transportation. Make sure that it cannot move.
- Make sure that there is no risk of fuel leaks, fuel fumes, sparks or flames during transportation and storage.
- Attach the transport guard during transportation and storage.
- Clean and do servicing on the product before long-term storage.

Disposal

- Obey the local recycling requirements and applicable regulations.
- Discard all chemicals, such as oil or fuel, at a service center or at an applicable disposal location.
- When the product is no longer in use, send it to a Husqvarna dealer or discard it at a recycling location.

Technical data

Engine	
Cylinder displacement, cm ³	34.6
Cylinder diameter, Ø mm	38.0
Cylinder stroke length, mm	30.5
Idle speed, rpm	2900
Recommended max. speed, rpm	11700
Speed of output shaft, rpm	9070
Max. engine output, according to ISO 8893, kW @ rpm	1.4 @ 8400
Catalytic converter muffler	Yes
Ignition system	
Spark plug	NGK CMR6A
Electrode gap, mm	0.5
Fuel and lubrication system	
Fuel tank capacity, l	0.6
Weight	
Without cutting attachment, harness and with empty tanks, kg	6.0
Noise emissions ¹	
Sound power level, measured dB(A)	114
Sound power level, guaranteed L _{WA} dB(A)	117
Noise levels ²	
Equivalent sound pressure level at the operator's ear, measured according to EN ISO 11806 and ISO 22868, dB(A), min./max.	
Equipped with trimmer head (original)	100
Equipped with grass blade (original)	100
Vibration levels ³	
Equivalent vibration levels (a _{hv,eq}) at handles, measured according to EN ISO 11806 and ISO 22867, m/s ²	
Equipped with trimmer head (original), front/rear	2.9/4.1

¹ Noise emissions in the environment measured as sound power (L_{WA}) in conformity with EC directive 2000/14/EC. Reported sound power level for the machine has been measured with the original cutting attachment that gives the highest level. The difference between guaranteed and measured sound power is that the guaranteed sound power also includes dispersion in the measurement result and the variations between different machines of the same model according to Directive 2000/14/EC.

² Reported data for equivalent sound pressure level has a typical statistical dispersion (standard deviation) of 1 dB (A).

³ Reported data for vibration level has a typical statistical dispersion (standard deviation) of 1 m/s².

Equipped with grass blade (original), front/rear	3.6/3.3
--	---------

Accessories

Approved accessories	Accessory type	Cutting attachment guard, art. no.
Center hole in blades/cutters, Ø 25.4 mm		
Output shaft thread M12		
Grass blade/grass cutter	Multi 255-3 (Ø 255 3 teeth)	537 33 16-07
	Grass 255-4 (Ø 255 4 teeth)	537 33 16-07
	Multi 275-4 (Ø 275 4 teeth)	537 33 16-07
Plastic blades	Tricut Ø 300 mm (Separate blades have part number 531 01 77-15)	537 33 16-07
Trimmer head	T35, T35x (Ø 2.4 - 3.0 mm cord)	537 33 16-07 573 34 94-03
	S35 (Ø 2.4 - 3.0 mm cord)	537 33 16-07 573 34 94-03
	T45x (Ø 2.7 - 3.3 mm cord)	537 33 16-07 573 34 94-03
Support cup	503 89 01-02	-

Declaration of Conformity

EU Declaration of Conformity

We, **Husqvarna AB**, SE-561 82 Huskvarna, Sweden, tel: +46-36-146500, declare on our sole responsibility that the product:

Description	Brush cutter
Brand	Husqvarna
Type / Model	535RJ
Identification	Serial numbers dating from 2022 and onwards

complies fully with the following EU directives and regulations:

Regulation	Description
2006/42/EC	"relating to machinery"
2014/30/EU	"relating to electromagnetic compatibility"
2000/14/EC	"relating to the noise emissions in the environment"
2011/65/EU	"on the restriction of the use of certain hazardous substances in electrical and electronic equipment"

and that the following standards and/or technical specifications are applied: EN ISO 12100:2010, EN ISO 14982:2009, EN IEC 63000:2018, EN ISO 11806-1:2011



SMP Svensk Maskinprovning AB, Box 4053, SE-904 03 Umeå, Sweden has performed voluntary type examination according to annex IX of 2006/42/EC.

Certificate Number: SEC/09/2165

SMP Svensk Maskinprovning AB has also verified agreement with appendix V of the council's directive 2000/14/EC.

For information relating to noise emissions, refer to *Technical data on page 23*.

Huskvarna, 2023-06-13

Two handwritten signatures in black ink. The first signature is 'Stefan Holmberg' and the second is a more stylized signature, likely of the R&D Director mentioned in the text below.

Stefan Holmberg, R&D Director, Technology Management, Husqvarna AB

Responsible for technical documentation

UK Declaration of Conformity

We, **Husqvarna AB**, SE-561 82 Huskvarna, Sweden, tel: +46-36-146500, declare on our sole responsibility that the product:

Description	Brush cutter
Brand	Husqvarna
Type / Model	535RJ
Identification	Serial numbers dating from 2022 and onwards

complies fully with the following UK regulations:

Description
The Supply of Machinery (Safety) Regulations 2008
Electromagnetic Compatibility Regulations 2016
The Noise Emission in the Environment by Equipment for use Outdoors Regulations 2001, Schedule 8
The Restriction of the Use of Certain Hazardous Substances in Electrical and Electronic Equipment Regulations 2012

and that the following standards and/or technical specifications are applied: EN ISO 12100:2010, EN ISO 14982:2009, EN IEC 63000:2018, EN ISO 11806-1:2011

For information relating to noise emissions, refer to *Technical data on page 23*.

Huskvarna, 2023-06-13

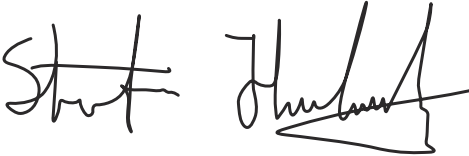

Stefan Holmberg, R&D Director, Technology Management, Husqvarna AB

Responsible for technical documentation

**UK
CA**

UK Importer:
Husqvarna UK Ltd
Preston Road, Co. Durham
DL5 6UP

Tri Cut

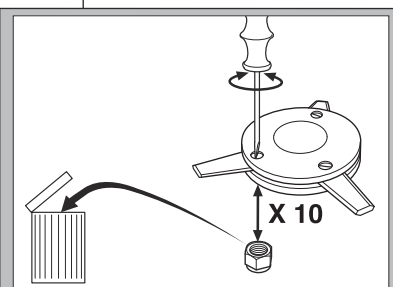
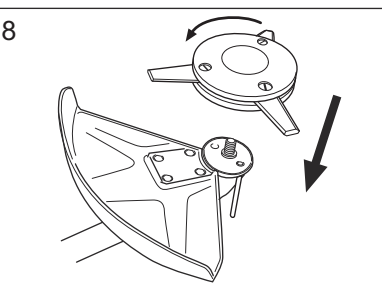
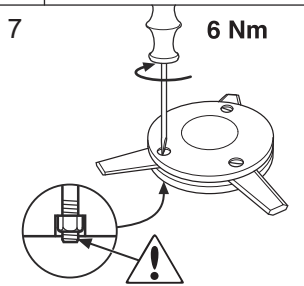
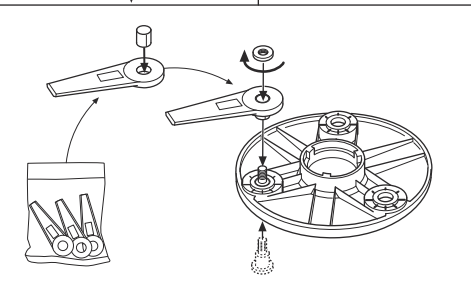
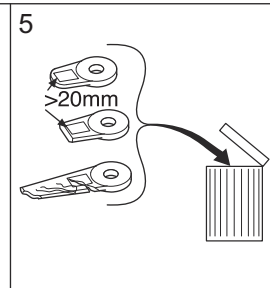
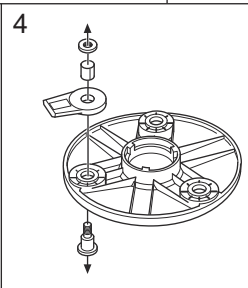
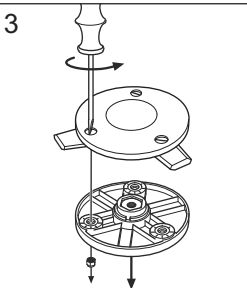
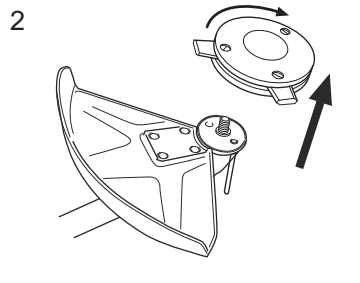
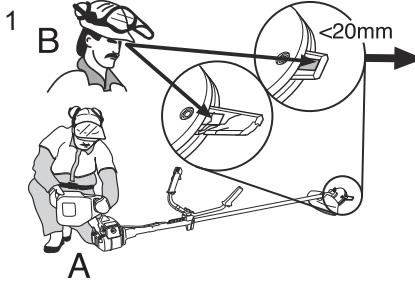

S35

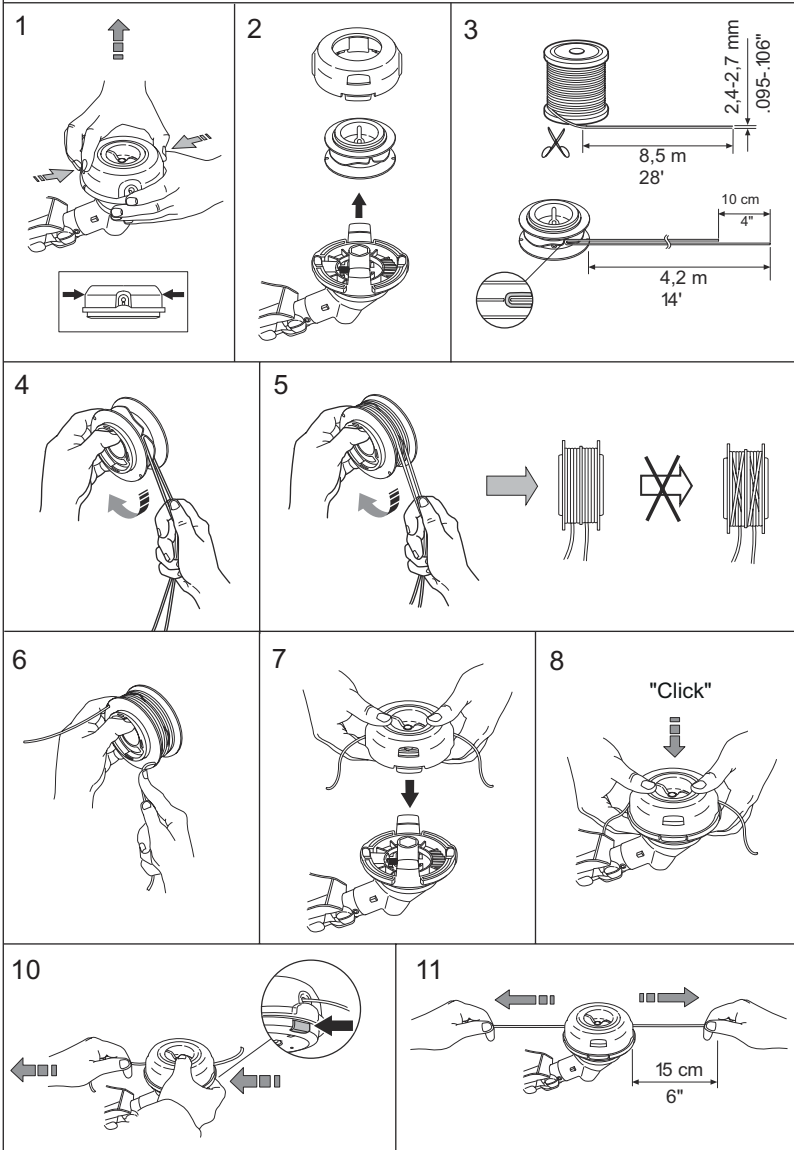

S35



1

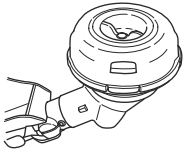

2

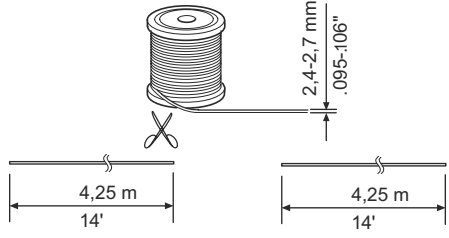

3

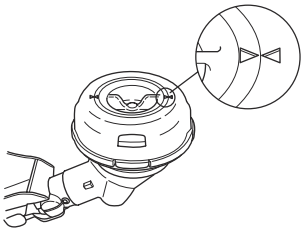

4

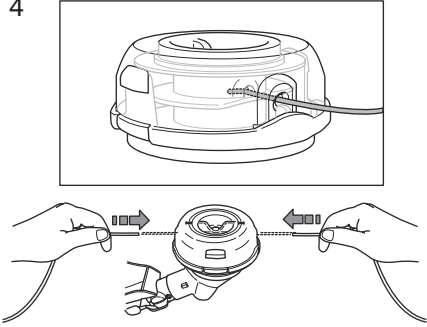

5

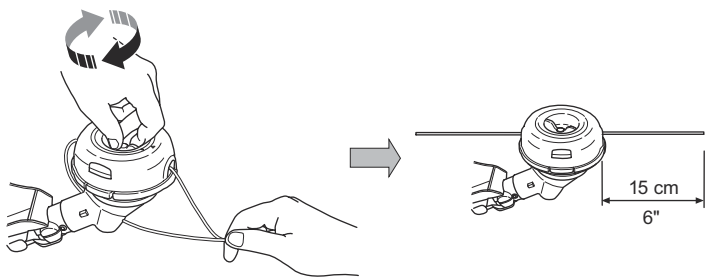

A

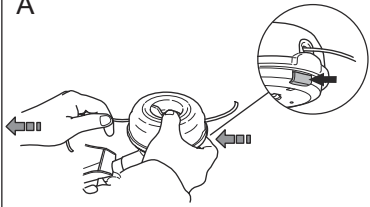

B

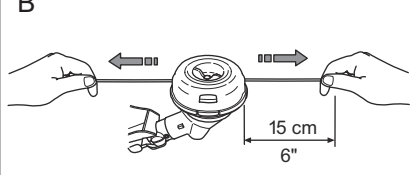

T35, T35x

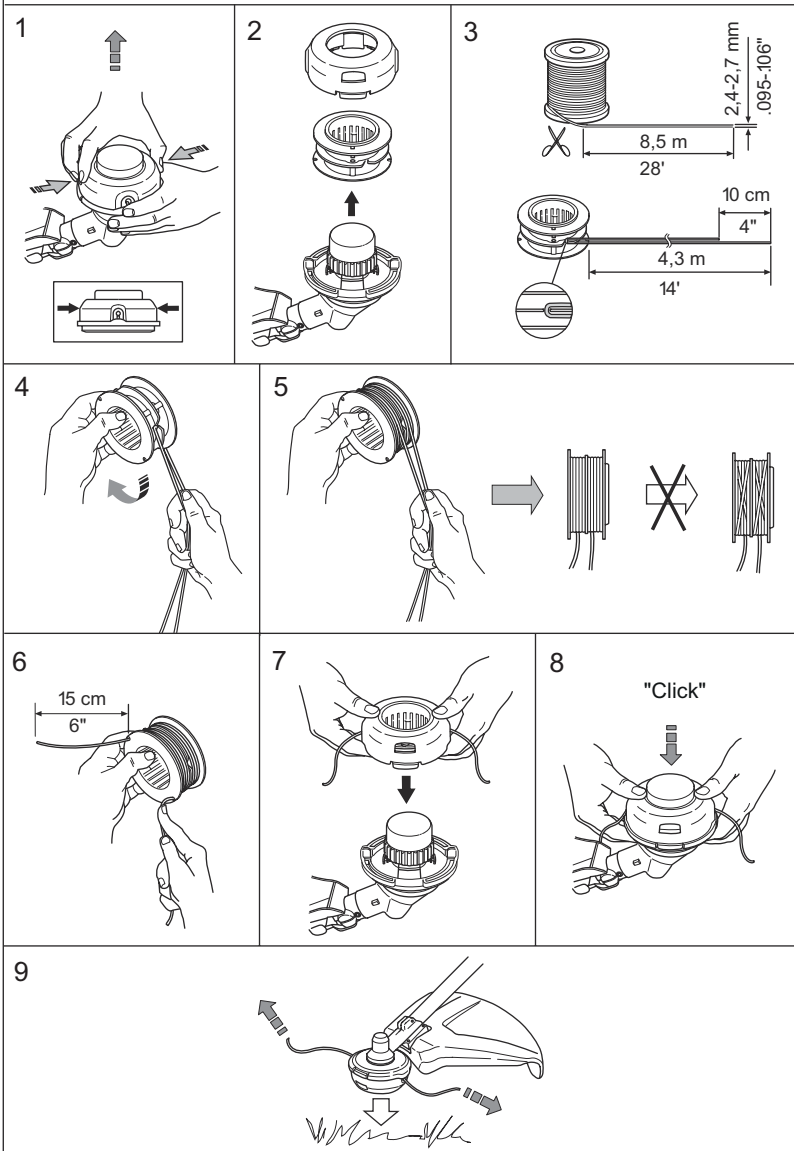

T45, T45x

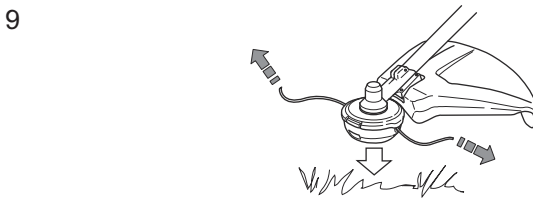
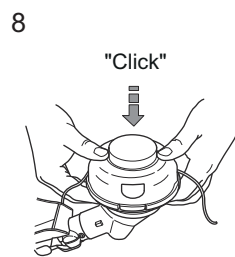
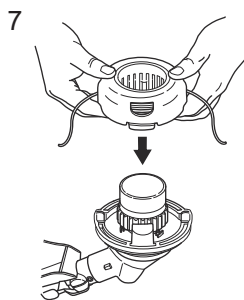
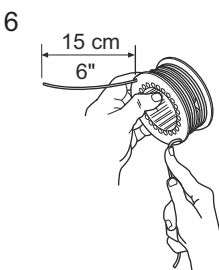
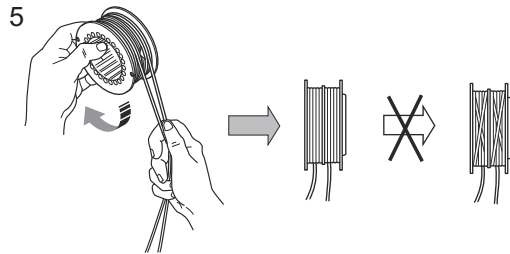
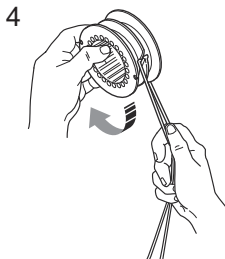
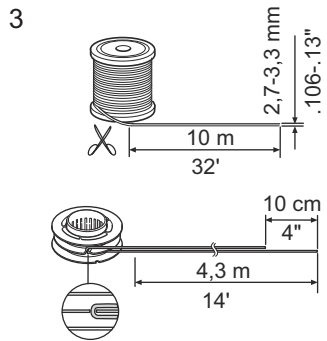
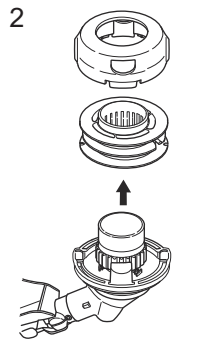
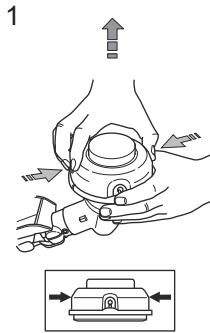

Husqvarna®

www.husqvarna.com

Original instructions



1143418-26



2024-05-02