

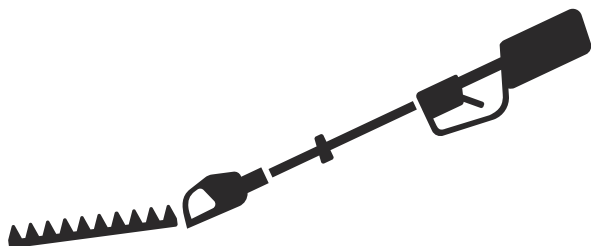

Husqvarna®



525HF3S

Contents

Introduction.....	2	Troubleshooting.....	15
Safety.....	3	Transportation, storage and disposal.....	16
Assembly.....	8	Technical data.....	16
Operation.....	9	Declaration of Conformity.....	18
Maintenance.....	11		

Introduction

Product description

The product is a pole hedge trimmer with a combustion engine.

Intended use

Use the product to cut branches and twigs. Do not use the product for other tasks.

Product overview

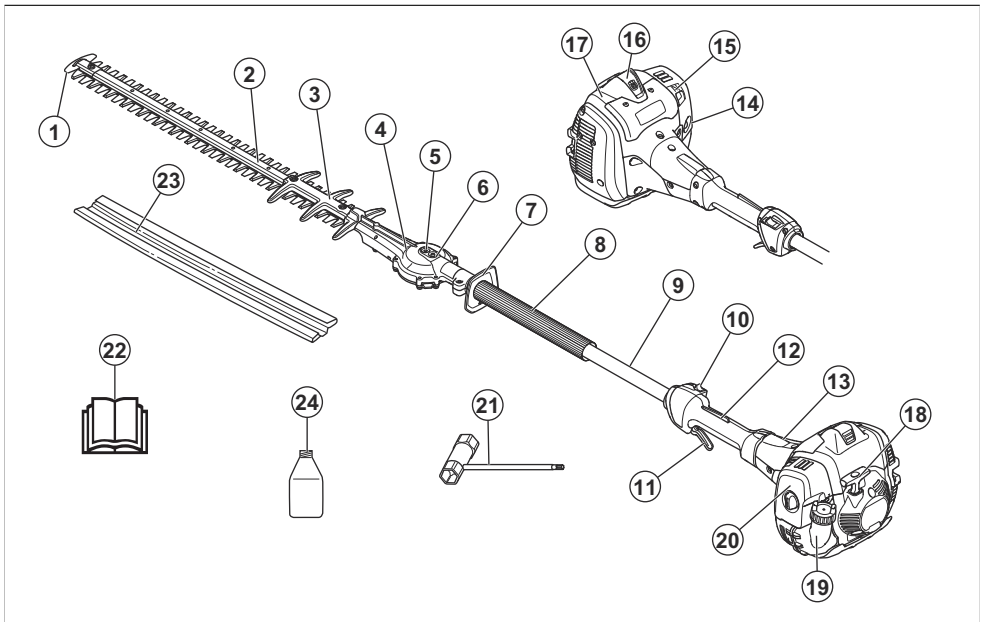

- | | |
|--|---|
| 1. Blade tip protection | 13. Clutch cover |
| 2. Cutting unit | 14. Air purge bulb |
| 3. Blade guard | 15. Choke control |
| 4. Gear | 16. Spark plug cap and spark plug |
| 5. Socket for manual release of the blades | 17. Cylinder cover |
| 6. Grease nipple | 18. Starter rope handle |
| 7. Hand guard | 19. Fuel tank |
| 8. Front handle | 20. Air filter cover |
| 9. Shaft | 21. Combination wrench |
| 10. Stop switch | 22. Operator's manual |
| 11. Throttle trigger | 23. Transport guard |
| 12. Throttle trigger lockout | 24. 2-stroke oil. Not included for all markets. |

Symbols on the product



WARNING: This product can be dangerous and cause serious injury or death to the operator or others. Be careful and use the product correctly.



Read the operator's manual carefully and make sure that you understand the instructions before you use this product.



Use a protective helmet in locations where objects can fall on you. Use approved hearing protection. Use approved eye protection.

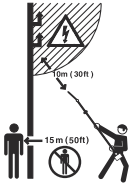

There is no electrical insulation in this product. If the product touches or comes near high voltage power lines, it can cause serious injury or death to the operator. Electricity can move between different objects by a curve. The higher the voltage, the longer the electricity can move. Electricity can also move through branches and other objects, especially if the object is wet. Always keep a distance at a minimum of 10 m/33 ft between the product and high voltage power lines and/or objects that touches the power lines. If it is necessary to do work near the power lines, make sure that the power is off before you start the work. Keep a distance at a minimum of 15 m/50 ft to other persons or animals during the operation.



Use stable boots with non-slip soles.



Use approved protective gloves.



Stop the product fully before you touch the cutting tool.



Noise emission to the environment label as per EU and UK directives and regulations, and New South Wales legislation Protection of the Environment Operations (Noise Control) Regulation 2017. The guaranteed sound power level of the product is specified in *Technical data on page 16* and on the label.

yyyywwxxxx

The rating plate shows serial number. **yyyy** is the production year and **ww** is the production week.

Note: Other symbols/decals on the product refer to special certification requirements for some markets.



The product agrees with the applicable EC directives.



This product conforms to the applicable UK regulations.

Euro V Emissions



WARNING: Tampering with the engine voids the EU type-approval of this product.

Safety

Safety definitions

Warnings, cautions and notes are used to point out specially important parts of the manual.



WARNING: Used if there is a risk of injury or death for the operator or bystanders if the instructions in the manual are not obeyed.



CAUTION: Used if there is a risk of damage to the product, other materials or the adjacent area if the instructions in the manual are not obeyed.

Note: Used to give more information that is necessary in a given situation.

General safety instructions



WARNING: Read the warning instructions that follow before you use the product.

- Incorrect or careless use of the product can turn it into a dangerous tool that can cause serious or even fatal injury. It is extremely important that you read and understand the contents of this operator's manual.
- This product produces an electromagnetic field during operation. This field may under some circumstances interfere with active or passive medical implants. To reduce the risk of serious or fatal injury, we recommend persons with medical implants to consult their physician and the medical implant manufacturer before operating this product.
- Overexposure to vibration can lead to circulatory damage or nerve damage in people who have impaired circulation. Contact your doctor if you experience symptoms of overexposure to vibration. Such symptoms include numbness, loss of feeling, tingling, pricking, pain, loss of strength, changes in skin color or condition. These symptoms normally appear in the fingers, hands or wrists. The risk increases at low temperatures.
- If you encounter a situation where you are uncertain how to proceed you should ask an expert. Contact your dealer or your service workshop. Avoid all usage which you consider to be beyond your capability.
- A used muffler/spark arrester and spark arrester mounting face may contain deposits of combustion particles that may be carcinogenic. Avoid being exposed to these compounds when handling the muffler and/or spark arrester. Prior to any handling of the muffler and/or the spark arrester, refer to *To do a check of the muffler on page 7*.
- Keep in mind that the operator is responsible for accidents or hazards occurring to other people or their property.
- Never allow anyone else to use the product without first ensuring that they have understood the contents of the operator's manual.
- Never allow children to use or be in the vicinity of the product. As the product is equipped with a spring-loaded stop switch and can be started by low speed and force on the starter handle, even small children under some circumstances can produce the force necessary to start the product. This can mean a risk of serious personal injury. Therefore remove the spark plug cap when the product is not under close supervision.
- Store the product out of reach of children.
- Never use the product if you are tired, if you have drunk alcohol, or if you are taking medication that could affect your vision, your judgement or your coordination.

- Never use a product that is faulty. Carry out the checks, maintenance and service instructions described in this manual. Some maintenance and service measures must be carried out by trained and qualified specialists. Refer to instructions under the heading Maintenance.
- Never use a product that has been modified in any way from its original specification.

Safety instructions for operation



WARNING: Read the warning instructions that follow before you use the product.

- Never use the product in extreme weather conditions such as severe cold, very hot and/or humid climates.
- Faulty blades can increase the risk of accidents.
- Ensure that no people or animals comes closer than 15 m / 50 ft while you work.
- Observe your surroundings and make sure that there is no risk of people or animals coming into contact with the cutting equipment.
- Inspect the working area. Remove any objects that could be thrown out.
- Always ensure you have a safe and stable working position.
- Never leave the product unsupervised with the engine running.
- Make sure that your hands and feet do not come near the cutting unit when the engine is running.
- If anything jams in the blades while you are working, switch off the engine and wait until it has stopped completely before cleaning the blades. Disconnect the spark plug cap from the spark plug.
- When the engine is switched off, keep your hands and feet away from the cutting unit until it has stopped completely.
- Watch out for stumps of branches that can be thrown out during cutting.
- Listen out for warning signals or shouts when you are wearing hearing protection. Always remove your hearing protection as soon as the engine stops.
- Never work from a ladder, stool or any other raised position that is not fully secured.
- Always use both hands to hold the product. Hold the product in front of your body.
- If any foreign object is hit or if vibrations occur stop the product immediately. Disconnect the spark plug cap from the spark plug. Check that the product is not damaged. Repair any damage.
- Ensure that the spark plug cap and ignition lead are undamaged to avoid the risk of electric shock.
- Check that all nuts and screws are tight.
- Make sure the gearbox is lubricated correctly. Refer to *Product overview on page 2*.

- The gearbox gets hot when the product has been in use. To avoid burning yourself do not touch the gearbox.
- All covers and guards must be fitted before starting.
- If the blades get stuck, they can be loosened by sticking the combination wrench into the gearbox. Stick the combination wrench into the gearing and turn it back and forth. Refer to *To lubricate the gear housing on page 14*.
- The transport guard should always be fitted to the cutting unit when the product is not in use.

Personal protective equipment



WARNING: Read the warning instructions that follow before you use the product.

- Always use approved personal protective equipment when you use the product. Personal protective equipment cannot fully prevent injury but it decreases the degree of injury if an accident does occur. Let your dealer help you select the right equipment.
- Use approved hearing protection that provides adequate noise reduction. Long-term exposure to noise can result in permanent hearing impairment.
- Use approved eye protection. If you use a visor, you must also use approved protective goggles. Approved protective goggles must comply with the ANSI Z87.1 standard in the USAs or EN 166 in EU countries.

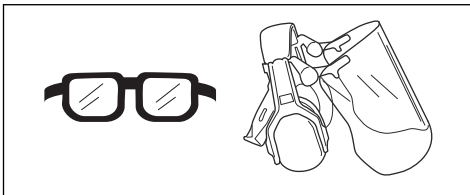

- Use gloves when necessary, for example when you attach, examine or clean the cutting equipment.

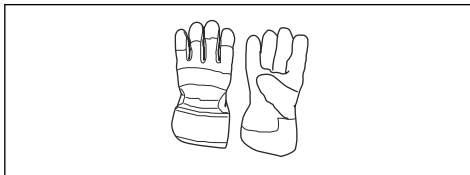

- Use sturdy non-slip boots or shoes.

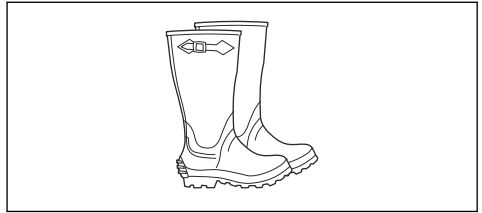

- Use clothing made of a strong fabric. Always use heavy, long pants and long sleeves. Do not use loose clothing that can catch on twigs and branches. Do not wear jewelry, short pants, sandals or go with bare feet. Put your hair up safely above shoulder level.
- Keep first aid equipment close at hand.

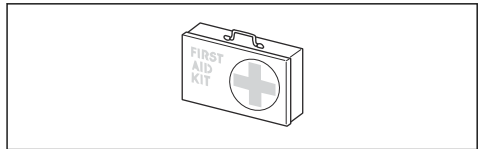

Safety devices on the product



WARNING: Read the warning instructions that follow before you use the product.

- Do not use a product with safety devices that are damaged or do not operate correctly.
- Do a check of the safety devices regularly. If the safety devices are damaged or do not operate correctly, speak to your Husqvarna service agent.
- Do not make modifications to safety devices.

To do a check of the throttle trigger lockout

1. Make sure that the throttle trigger lockout (A) and throttle trigger (B) move freely and that the return spring operates correctly.

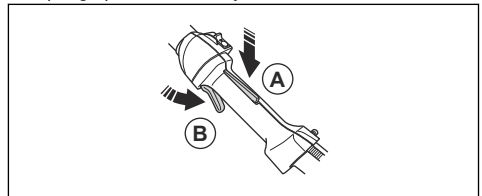

2. Make sure that the throttle trigger is locked at the idle position when the throttle trigger lockout is released.

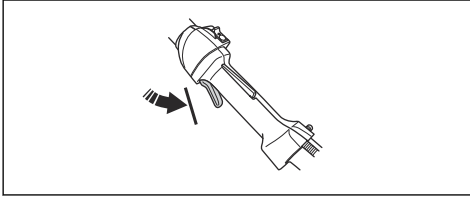

3. Push down the throttle trigger lockout and make sure that it goes back to its initial position when you release it.

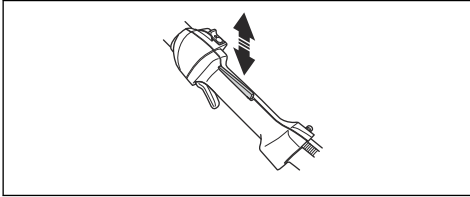

4. Start the product. Refer to *To start the engine on page 10*. Apply full throttle.

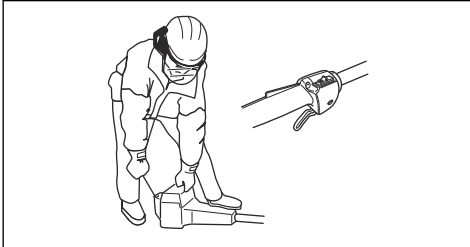

5. Release the throttle trigger and make sure that the blades stop and stay stationary.



WARNING: If the blades move when the throttle trigger is in the idle position, then the carburetor idle speed must be adjusted. Refer to *To adjust the idle speed on page 12*.

To do a check of the stop switch

1. Start the engine.
2. Move the stop switch to the stop position and make sure that the engine stops.

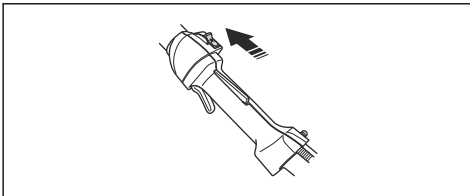

To do a check of the hand guard

The hand guard prevents injuries from the blades.

1. Stop the engine.
2. Make sure that the hand guard is attached correctly.

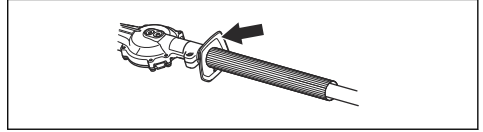

3. Examine the hand guard for damages.

To do a check of the vibration damping system



WARNING: Use of incorrectly wound cord or an incorrect cutting attachment increases the level of vibration.

The vibration damping system decreases vibration in the handles to a minimum which makes the operation easier. The vibration damping system decreases the vibrations between the engine unit and the shaft unit.

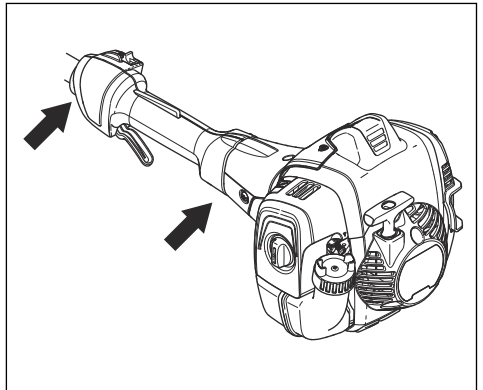

1. Stop the engine.
2. Do a visual check for deformation and damage, for example cracks.
3. Make sure that the vibration damping units are attached correctly.

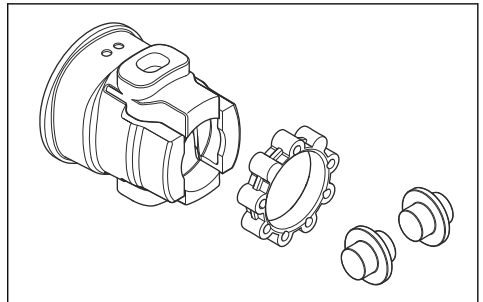

To do a check of the muffler



WARNING: A used muffler/spark arrester and spark arrester mounting face may contain deposits of combustion particles on the surfaces that may be carcinogenic. To avoid skin contact and inhalation of such particles when cleaning and/or servicing the spark arrester, make sure you always:

- wear gloves;
- clean and/or service in a well ventilated area;
- do not use pressurized air to clean the spark arrester screen;
- use a steel brush and brush away from your body when cleaning the spark arrester.



WARNING: Do not use a product that has a defective muffler or a muffler that is in bad condition. Return product to a Husqvarna dealer/service station if the muffler is defective.

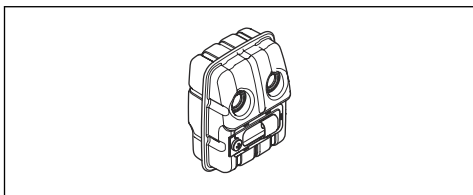

The muffler keeps noise levels to a minimum and sends exhaust fumes away from the operator.

- Do a visual check for damage and deformation.
- Make sure that the muffler is correctly attached to the product.

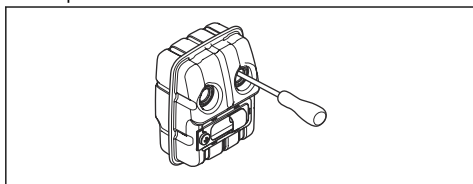

Note: Do not remove the muffler from the product.

- If the muffler on your product has a spark arrester screen, do a visual check. Replace the spark arrester screen if it is damaged.
 - a) Clean the spark arrester screen if it is blocked. A blocked spark arrester screen causes the engine to become too hot which causes damage to the engine.

- b) Make sure that the spark arrester mesh is attached correctly.

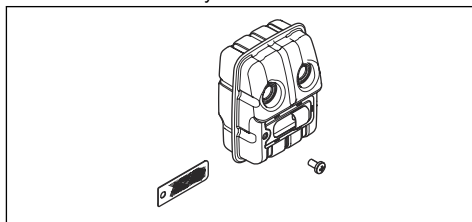

To do a check of the blades and blade guard

The outer part of the blades has the function of a blade guard. The blade guard prevents cut injuries.

1. Stop the engine and make sure that the blades stop.
2. Remove the spark plug cap from the spark plug.
3. Put on protective gloves.
4. Make sure that the blade and blade guard is not damaged or bent. Always replace a damaged or bent blade, or a damaged blade guard.
5. Make sure that the screws to the blades and blade guard are tight.

Fuel safety



WARNING: Read the warning instructions that follow before you use the product.

- Do not mix the fuel indoor or near a heat source.
- Do not start the product if there is fuel or engine oil on the product. Remove the unwanted fuel/oil and let the product dry. Remove unwanted fuel from the product.
- If you spill fuel on your clothing, change clothing immediately.
- Do not get fuel on your body, it can cause injury. If you get fuel on your body, use a soap and water to remove the fuel.
- Do not start the engine if you spill oil or fuel on the product or on your body.
- Do not start the product if the engine has a leak. Examine the engine for leaks regularly.
- Be careful with fuel. Fuel is flammable and the fumes are explosive and can cause injuries or death.
- Do not breathe in the fuel fumes, it can cause injury. Make sure that there is sufficient airflow.
- Do not smoke near the fuel or the engine.
- Do not put warm objects near the fuel or the engine.
- Do not add the fuel when the engine is on.
- Make sure that the engine is cool before you refuel.
- Before you refuel, open the fuel tank cap slowly and release the pressure carefully.

- Make sure there are sufficient airflow when refueling and mixing fuel (petrol and two-stroke oil) or draining the fuel tank.
- Fuel and fuel vapor are highly flammable and can cause serious injury when inhaled or allowed to come into contact with the skin. For this reason, observe caution when handling fuel and make sure there is sufficient airflow.
- Tighten the fuel tank cap carefully or a fire can occur.
- Move the product at a minimum of 3 m (10 ft) from the position where you filled the tank before a start.
- Do not put too much fuel in the fuel tank.
- Make sure that a leak cannot occur when you move the product or fuel container.
- Do not put the product or a fuel container where there is an open flame, spark or pilot light. Make sure that the storage area does not contain an open flame.
- Only use approved containers when you move the fuel or put the fuel into storage.
- Empty the fuel tank before long-term storage. Obey the local law on where to dispose fuel.
- Clean the product before long-term storage.
- Remove the spark plug cap before you put the product into storage to make sure that the engine does not start accidentally.
- Stop the engine and make sure that the cutting equipment stops. Let the product become cool before you do the maintenance.
- Disconnect the spark plug cap before you do the maintenance.
- The exhaust fumes from the engine contain carbon monoxide, an odourless, poisonous and very dangerous gas that can cause death. Do not run the product indoors or in closed spaces.
- The exhaust fumes from the engine are hot and can contain sparks. Do not run the product indoors or near flammable material.
- Accessories and changes to the product that are not approved by the manufacturer, can cause serious injury or death. Do not change the product. Always use original accessories.
- If the maintenance is not done correctly and regularly, there is an increased risk of injury and damage to the product.
- Only do the maintenance as this operator's manual recommends. Let an approved Husqvarna service agent do all other servicing.
- Let an approved Husqvarna service agent do servicing on the product regularly.
- Replace damaged, worn or broken parts.

Safety instructions for maintenance



WARNING: Read the warning instructions that follow before you use the product.

Assembly

Introduction



WARNING: Read and understand the safety chapter before you assemble the product.

To install the cutting unit

1. Loosen the screw on the cutting unit (A).

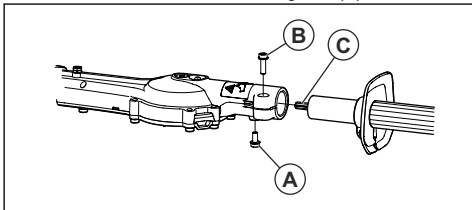

2. Put the shaft in the cutting unit. Align the screw (A) with the hole in the shaft.



CAUTION: Make sure that the drive shaft (C) engages with the gear in the cutting unit.

3. Tighten the screw (A) with your fingers. Make sure that screw (A) goes into the hole in the shaft.
4. Tighten the screw (A) fully.
5. Tighten the screw (B) fully.

Operation

Introduction



WARNING: Read and understand the safety chapter before you use the product.

To do before you operate the product

- Examine the work area and remove loose objects.
- Do a check of the cutting unit. Refer to *To do a check of the blades and blade guard on page 7*.
- Make sure that the gear housing is correctly lubricated.
- Make sure that the safety devices of the product operates correctly. Do not use the product without all safety devices installed correctly.
- Make sure that all screws and nuts are tight.
- Make sure that all covers are attached correctly and not damaged before you start the product.
- Make sure that the cutting unit stops when the engine is at idle speed.

Fuel

This product has a two-stroke engine.



CAUTION: Incorrect type of fuel can result in engine damage. Use a mixture of gasoline and two-stroke oil.

Premixed fuel

- Use Husqvarna premixed alkylate fuel for best performance and extension of the engine life. This fuel contains less harmful chemicals compared to regular fuel, which decreases harmful exhaust fumes. The quantity of remains after combustion is lower with this fuel, which keeps the components of the engine more clean.

To mix fuel

Gasoline

- Use good quality unleaded gasoline with a maximum of 10% ethanol contents.



CAUTION: Do not use gasoline with an octane grade less than 90 RON/87 AKI. Use of a lower octane grade can cause engine knocking, which causes engine damages.

Two-stroke oil

- For best results and performance use Husqvarna two-stroke oil.

- If Husqvarna two-stroke oil is not available, use a two-stroke oil of good quality for air-cooled engines. Speak to your servicing dealer to select the correct oil.



CAUTION: Do not use two-stroke oil for water-cooled outboard engines, also referred to as outboard oil. Do not use oil for four-stroke engines.

To mix gasoline and two-stroke oil

Gasoline, liter	Two-stroke oil, liter
	2% (50:1)
5	0.10
10	0.20
15	0.30
20	0.40



CAUTION: Small errors can influence the ratio of the mixture drastically when you mix small quantities of fuel. Measure the quantity of oil carefully and make sure that you get the correct mixture.

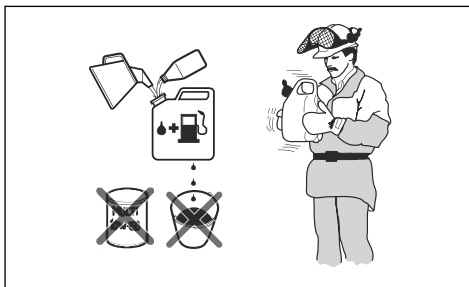

1. Fill half the quantity of gasoline in a clean container for fuel.
2. Add the full quantity of oil.
3. Shake the fuel mixture.
4. Add the remaining quantity of gasoline to the container.
5. Carefully shake the fuel mixture.



CAUTION: Do not mix fuel for more than 1 month at a time.

To fill the fuel tank



WARNING: Obey the procedure that follows for your safety.

1. Stop the engine and let the engine become cool.
2. Clean the area around the fuel tank cap.

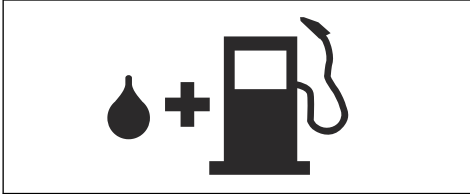

3. Shake the container and make sure that the fuel is fully mixed.
4. Remove the fuel tank cap slowly to release the pressure.
5. Fill the fuel tank.



CAUTION: Make sure that there is not too much fuel in the fuel tank. The fuel expands when it becomes hot.

6. Tighten the fuel tank cap carefully.
7. Clean fuel spillage on and around the product.
8. Move the product 3 m/10 ft or more away from the refueling area and fuel source before you start the engine.

Note: To see where the fuel tank is on your product, refer to *Product overview on page 2*.

To start the engine



WARNING: Keep a minimum distance of 15 m/50 ft from persons or animals when you start the product. There is a risk that the cutting unit starts to move.

1. Set the choke control in the choke position.

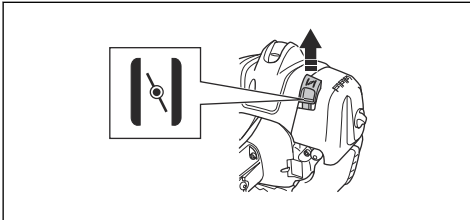

2. Push the air purge bulb until the bulb starts to fill with fuel.

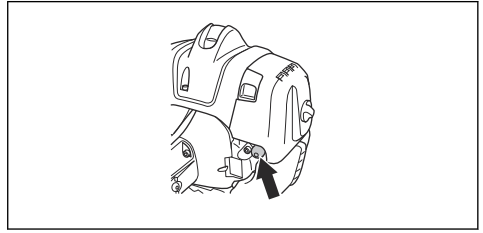

Note: It is not necessary to fill the air purge bulb fully.

3. Hold the body of the product on the ground with your left hand. Do not put your feet on the product.

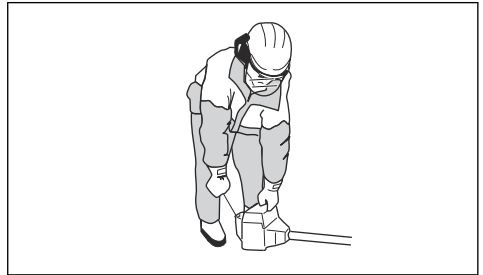

4. Pull the starter rope handle slowly until you feel some resistance, then pull the starter rope handle with force.



WARNING: Do not wind the starter rope around your hand.

5. Continue to pull the starter rope handle until the engine starts.



CAUTION: Do not pull the starter rope to full extension and do not let go of the starter rope handle. Release the starter rope slowly to prevent damage to the product.

6. When the engine starts, put the choke control in the run position and apply full throttle. The throttle trigger automatically disengages from the start position.
7. Make sure that the engine operates smoothly.



WARNING: Do not use the product with a damaged spark plug cap to prevent electrical shock.

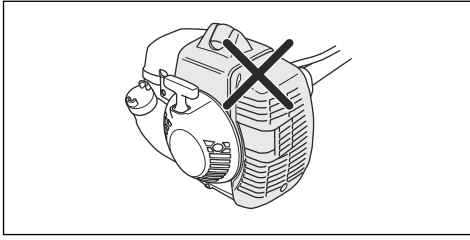

Note: To start the product when the engine is warm, it is not necessary to use the choke control.

To stop the product

- Move the stop switch to the stop position to stop the engine.



CAUTION: The stop switch automatically goes back to run position.

To operate the product

- Start near the ground and move the product up along the hedge when you cut the sides.

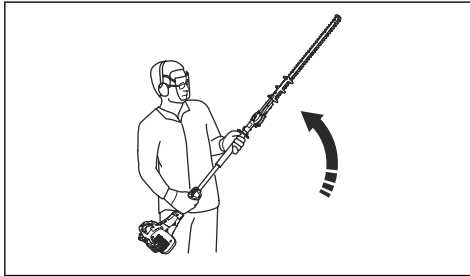

- Adjust the speed to align with the work load.
- Make sure that the engine does not touch the hedge.
- Hold the product near your body for a stable work position.

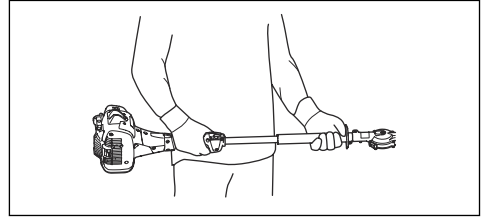

- Make sure that the tip of the cutting equipment does not touch the ground.
- Be careful and work slowly until all the branches are correctly cut.

Maintenance

Introduction



WARNING: Read and understand the safety chapter before you do maintenance on the product.

Maintenance schedule

Maintenance	Before operation	After 40 h	After 100 h
Clean the external surface.	After each operation.		
Clean the muffler, exhaust pipe and engine from leaves, dirt and unwanted lubricant.	After each operation.		
Make sure that the cutting unit does not move at idle speed.	X		

Maintenance	Before operation	After 40 h	After 100 h
Do a check of the stop switch. Refer to <i>To do a check of the stop switch on page 6.</i>	X		
Examine the cutting unit for damages and cracks. Replace if it is damaged.	X		
Examine the hand guard for damages and cracks. Replace if it is damaged.	X		
Do a check of the throttle trigger lockout and the throttle trigger. Refer to <i>To do a check of the throttle trigger lockout on page 5.</i>	X		
Examine the engine, the fuel tank and the fuel hose for leaks.	X		
Tighten nuts and screws.	X		
Examine the starter and the starter rope for damages.		X	
Do a check that the screws that hold the blades together are correctly tightened.		X	
Clean the air filter. Clean more frequently if used in areas which has dust. Replace if it is damaged.		X	
Examine the vibration damping units for damages and cracks. Replace if it is damaged.		X	
Clean the external surface of the spark plug and the area around it. Remove the spark plug and measure the electrode gap. Adjust the electrode gap or replace the spark plug. Refer to <i>To examine the spark plug on page 13.</i>		X	
Clean the cooling system.		X	
Clean the external surface of the carburetor and the area around it.		X	
Examine the fuel filter for contamination and the fuel hose for cracks and other defects. Replace if it is damaged.			X
Clean or replace the spark arrester screen on the muffler. Refer to <i>To do a check of the muffler on page 7.</i>		X	
Clean the inner surface of the fuel tank.			X
Replace the spark plug.			X
Examine the clutch, clutch spring and the clutch drum for wear. Replace if it is damaged by an approved servicing dealer.			X
Make sure that the gear housing is filled with grease.			X
Do a check of all cables and connections.			X

To adjust the idle speed

1. Clean the air filter and attach the air filter cover.
2. Start the product. Refer to *To start the engine on page 10.*

3. Turn the idle adjustment screw T clockwise until the cutting unit starts to move.

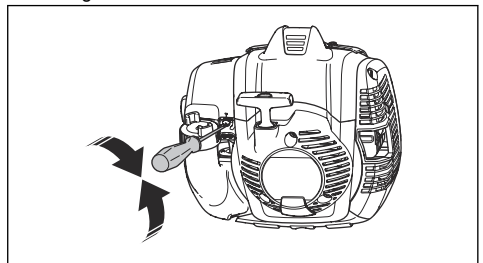

- Turn the idle adjustment screw counterclockwise until the cutting unit stops.



WARNING: If the cutting unit does not stop when you adjust the idle speed, speak to your nearest servicing dealer. Do not use the product until it is correctly adjusted or repaired

Note: The idle speed is correct when the engine operates smoothly in all positions. Refer to for the recommended idle speed.

To do maintenance on the muffler

The muffler decreases the noise level and directs the exhaust gases away from the operator.



WARNING: Mufflers that have catalytic converters get very hot during operation and will stay hot for some time after you stop the product. This also applies at idle speed. If you touch the product it can result in burns to the skin. Think about of the risk of fire.

- Stop the product and let it cool down.
- Remove the cover to the muffler.

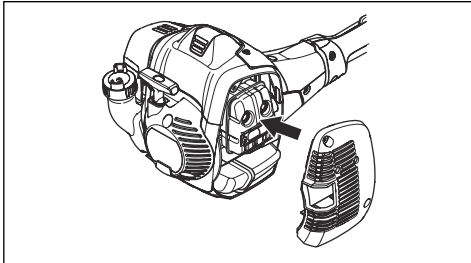

- Remove the screw holding the spark arrestor mesh.

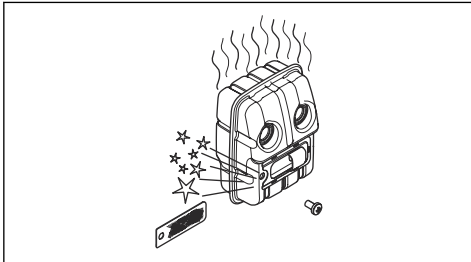

- Clean the spark arrestor mesh if it is blocked or replace it if it is damaged.



CAUTION: The spark arrestor mesh must be replaced if it is damaged. Do not use a product if the spark arrestor mesh on the muffler is missing or damaged.



CAUTION: If the spark arrestor mesh is frequently blocked it can be a sign that performance of the catalytic converter is decreased. Turn to your servicing dealer to examine the muffler. A blocked spark arrestor mesh will cause overheating and result in damage to the cylinder and piston.

Cooling system

The product has a cooling system to keep the operation temperature as low as possible.

Clean the components of the cooling system with a brush weekly or more frequently in rougher conditions. A dirty or blocked cooling system makes the product too hot which causes damage to the piston and cylinder.

The cooling system has the following components:

- Air intake on the starter.
- Fins on the flywheel.
- Cooling fins on the cylinder.
- Cylinder cover.
- Muffler cover.
- Muffler plate.

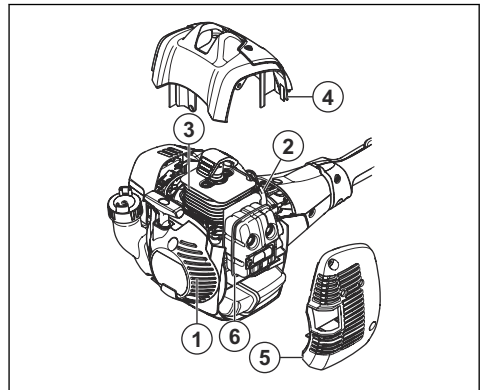

To examine the spark plug



CAUTION: Always use the recommended spark plug type, refer to *Technical data on page 16*. Incorrect spark plug type can cause damage to the product.

- Examine the spark plug if the engine is low on power, is not easy to start or does not operate correctly at idle speed.
- To decrease the risk of unwanted material on the spark plug electrodes, obey these instructions:
 - Make sure that the idle speed is correctly adjusted.
 - Make sure that the fuel mixture is correct.

- c) Make sure that the air filter is clean.
- If the spark plug is dirty, clean it and make sure that the electrode gap is correct, refer to *Technical data on page 16*.

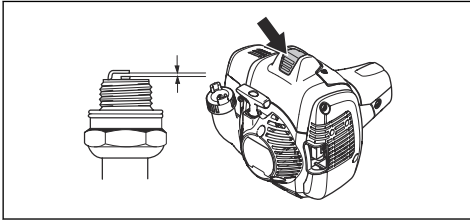

- Replace the spark plug if it is necessary.

Air filter

Remove dust and dirt from the air filter to keep it clean and prevent these problems:

- Carburetor malfunctions.
- Problems when you start the product.
- Loss of engine power.
- Increased wear to engine parts.
- Too much fuel consumption.

To clean the air filter



CAUTION: An air filter that is damaged, very dirty, or soaked with fuel must always be replaced.

Clean the air filter from dirt and dust regularly. This prevents carburetor malfunctions, starting problems, loss of engine power, wear to engine parts and more fuel consumption than usual.

If you use an air filter for a long time, it cannot be fully cleaned. Replace the air filter with a new one at regular intervals. Refer to *Maintenance on page 11*.

1. Move the choke lever up to close the choke valve.

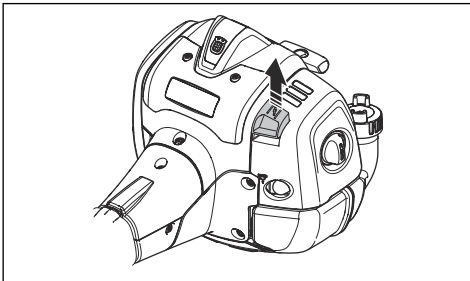

2. Remove the air filter cover and the air filters.

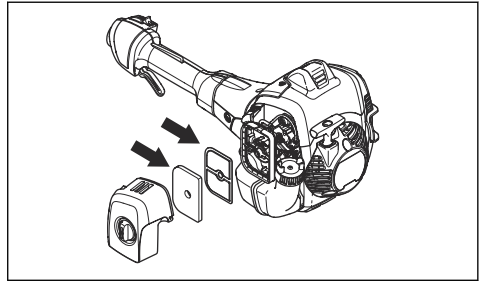

3. Clean the air filters with warm soap water.
4. Replace the air filters if they cannot be fully cleaned. Always replace a damaged air filter.
5. Clean the inner surface of the air filter cover. Use compressed air or a brush.
6. Do a check of the rubber seal on the air filter. Replace the air filter if the rubber seal is damaged.
7. Make sure that the air filter is dry before you install it.

To apply oil to the foam air filter



CAUTION: Always use Husqvarna special air filter oil. Do not use other types of oil.



WARNING: Put on protective gloves. The air filter oil can cause skin irritation.

1. Put the foam air filter in a plastic bag.
2. Put the oil in the plastic bag.
3. Rub the plastic bag to supply the oil equally across the foam air filter.
4. Push the unwanted oil out of the foam air filter while in the plastic bag.

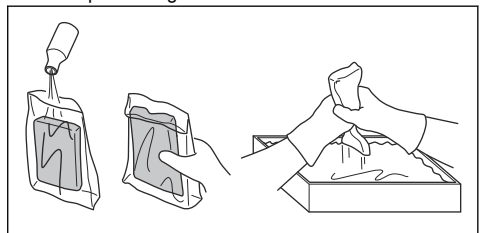

To lubricate the gear housing



WARNING: Do not touch the gear housing immediately after operation of the product. The gear housing is hot and can cause injury.

- Use Husqvarna special grease. Speak to your servicing dealer for more information about recommended grease.
- Add the grease through the grease nipple.

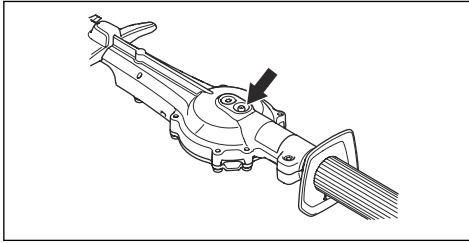

CAUTION: Do not fill the gear housing fully.

To clean and lubricate the blades

1. Clean the blades from unwanted materials before and after you use the product.
2. Lubricate the blades before long periods of storage.

Note: Speak to your servicing dealer for more information about recommended cleaning agents and lubricants.

To examine the blades

1. Remove the cap on the socket of the gear housing.
2. Put the combination wrench in the socket of the gear housing and turn clockwise and counterclockwise. Make sure that the blades move freely.

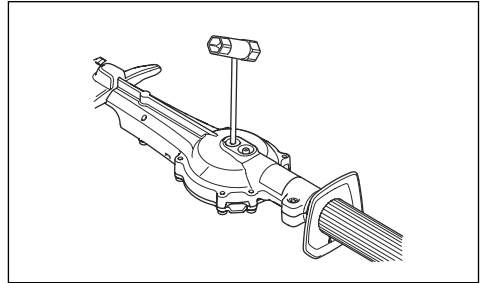

3. Examine the edges of the blades for damages and deformation.
4. Use a file to remove burrs on the blades.

Troubleshooting

The engine does not start		
Problem	Possible cause	Recommended step
Starter pawls	The starter pawls cannot move freely.	Adjust or replace the starter pawls.
		Clean around the starter pawls.
		Speak to an approved servicing dealer.
Fuel tank	Incorrect fuel type.	Drain it and use correct fuel.
Carburetor	Incorrect idle speed.	Adjust the idle speed.
No spark	The spark plug is dirty or wet.	Make sure that the spark plug is dry and clean.
	Incorrect electrode gap.	Clean the spark plug. Make sure that the electrode gap of the spark plug is correct. Make sure that the spark plug is installed with a suppressor.
		Refer to <i>Technical data on page 16</i> for correct electrode gap.
Spark plug	The spark plug is loose.	Tighten the spark plug.

The engine starts but stops again		
Problem	Possible cause	Recommended step
Fuel tank	Incorrect fuel type.	Drain it and use correct fuel.
Carburetor	Incorrect idle speed.	Adjust the idle speed. Refer to <i>To adjust the idle speed on page 12</i> . Speak to your servicing dealer if it is necessary.
Air filter	Clogged air filter.	Clean the air filter.

Blade		
Problem	Possible causes	Recommended step
The blade moves slowly or does not move.	The blade is blocked or it is damaged.	Clean the blades from unwanted materials. Refer to <i>To clean and lubricate the blades on page 15</i> . Remove burrs from the blade, refer to <i>To examine the blades on page 15</i> . Replace the blade if it is damaged.
The blade does not cut easily.	The blade is not sharp or it is damaged.	Sharpen the blade, refer to <i>To examine the blades on page 15</i> . Replace the blade if it is damaged.
The blade becomes hot.	There is friction between the blades.	Remove burrs from the blade and lubricate the blade. Refer to <i>To examine the blades on page 15</i> .

Transportation, storage and disposal

Transportation and storage

- Always allow the product to cool down before storage.
- For storage and transportation of the product and fuel, make sure that there are no leaks or fumes. Sparks or open flames, for example from electrical devices or boilers, can start a fire.
- Always use approved containers for storage and transportation of fuel.
- Empty the fuel before transportation or before long-term storage. Discard the fuel at an applicable disposal location.

- Attach the transport guard during transportation and storage.
- Remove the spark plug cap from the spark plug.
- Attach the product during transportation. Make sure that it cannot move.
- Clean and do servicing on the product before long-term storage.

Technical data

Technical data

	525HF3S
Engine	
Cylinder displacement, cm ³	24.5

	525HF3S
Cylinder bore, mm	34
Stroke, mm	27
Idle speed, rpm	3000
Recommended max speed, rpm	12000
Maximum engine power acc. to ISO 8893, kW/hp @ rpm	0.9/8500
Catalytic converter muffler	Yes
Speed-regulated ignition system	Yes
Ignition system	
Spark plug	NGK BPM8Y
Electrode gap, mm	0.65
Fuel and lubrication system	
Fuel tank capacity, l/cm ³	0.5/500
Weight	
Without fuel, kg	6.1
Noise emissions ¹	
Sound power level, measured dB (A)	105
Sound power level, guaranteed L _{WA} dB (A)	106
Sound levels ²	
Equivalent sound pressure level at the operator's ear, measured according to ISO 22868, dB(A)	92
Vibration levels ³	
Equivalent vibration levels (a _{nv,eq}) at handles, measured according to ISO 22867, m/s ² :	
Front/Rear, mm/s ²	3.9/2.9
Blades	
Length, mm	650
Blade speed, cuts/min	4339

¹ Noise emissions in the environment measured as sound power (L_{WA}) in conformity with EC directive 2000/14/EC. Reported sound power level for the product has been measured with the original cutting attachment that gives the highest level. The difference between guaranteed and measured sound power is that the guaranteed sound power also includes dispersion in the measurement result and the variations between different products of the same model according to Directive 2000/14/EC.

² Reported data for equivalent sound pressure level has a typical statistical dispersion (standard deviation) of 1 dB (A).

³ Reported data for equivalent vibration level has a typical statistical dispersion (standard deviation) of 1 m/s².

Declaration of Conformity

EU Declaration of Conformity

We, **Husqvarna AB**, SE-561 82 Huskvarna, Sweden, tel: +46-36-146500, declare on our sole responsibility that the product:

Description	Hedge trimmers
Brand	Husqvarna
Type / Model	525HF3S
Identification	Serial numbers dating from 2022 and onwards

complies fully with the following EU directives and regulations:

Directive/Regulation	Description
2006/42/EC	"relating to machinery"
2014/30/EU	"relating to electromagnetic compatibility"
2000/14/EC	"relating to the noise emissions in the environment, Annex V"
2011/65/EU	"on the restriction of the use of certain hazardous substances in electrical and electronic equipment"

and that the following standards and/or technical specifications are applied;

EN ISO 12100:2010, EN ISO 10517:2019, EN IEC 63000:2018, EN ISO 14982:2009.

SMP Svensk Maskinprovning AB, Box 4053, SE-904 03 Umeå, Sweden has performed a voluntary type examination according to annex IX of 2006/42/EC.

Certificate number: SEC/14/2406

SMP Svensk Maskinprovning AB has also verified agreement with annex V of the council's directive 2000/14/EC.

Huskvarna, 2023-07-07



A handwritten signature in black ink, appearing to read 'Stefan Holmberg', written over a horizontal line.

Stefan Holmberg

R&D Director, Technology Management

Husqvarna AB

Responsible for technical documentation

Declaration of Conformity

We, **Husqvarna AB**, SE-561 82 Huskvarna, Sweden, tel: +46-36-146500, declare on our sole responsibility that the product:

Description	Hedge trimmers
Brand	Husqvarna
Type / Model	525HF3S
Identification	Serial numbers dating from 2022 and onwards

complies fully with the following UK regulations:

Description
The Supply of Machinery (Safety) Regulations 2008
Electromagnetic Compatibility Regulations 2016
The Noise Emission in the Environment by Equipment for use Outdoors Regulations 2001, schedule 8
The Restriction of the Use of Certain Hazardous Substances in Electrical and Electronic Equipment Regulations 2012

and that the following standards and/or technical specifications are applied:

EN ISO 12100:2010

EN ISO 10517:2019

EN IEC 63000:2018

EN ISO 14982:2009

Husqvarna, 2023-07-07

UK Importer:
Husqvarna UK Ltd
Preston Road, Co. Durham
DL5 6UP

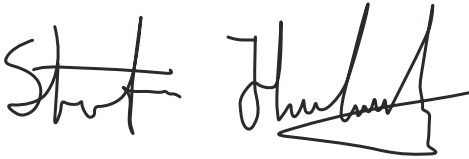

Stefan Holmberg

R&D Director, Technology Management

Husqvarna AB

Responsible for technical documentation

**UK
CA**



www.husqvarna.com

Original instructions



1143741-26



2023-09-15