

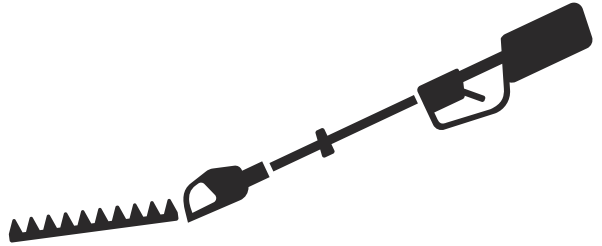

Husqvarna[®]



525iHF3

Contents

Introduction.....	2	Troubleshooting.....	15
Safety.....	4	Transportation, storage and disposal.....	16
Assembly.....	10	Technical data.....	18
Operation.....	11	Registered trademarks.....	19
Maintenance.....	14	Declaration of Conformity.....	20

Introduction

Product description

Husqvarna 525iHF3 is a battery pole hedge trimmer with an electrical motor.

Work is constantly in progress to increase your safety and efficiency during operation. Speak to your servicing dealer for more information.

Intended use

Use the product to cut branches and twigs. Do not use the product for other tasks.

Product overview

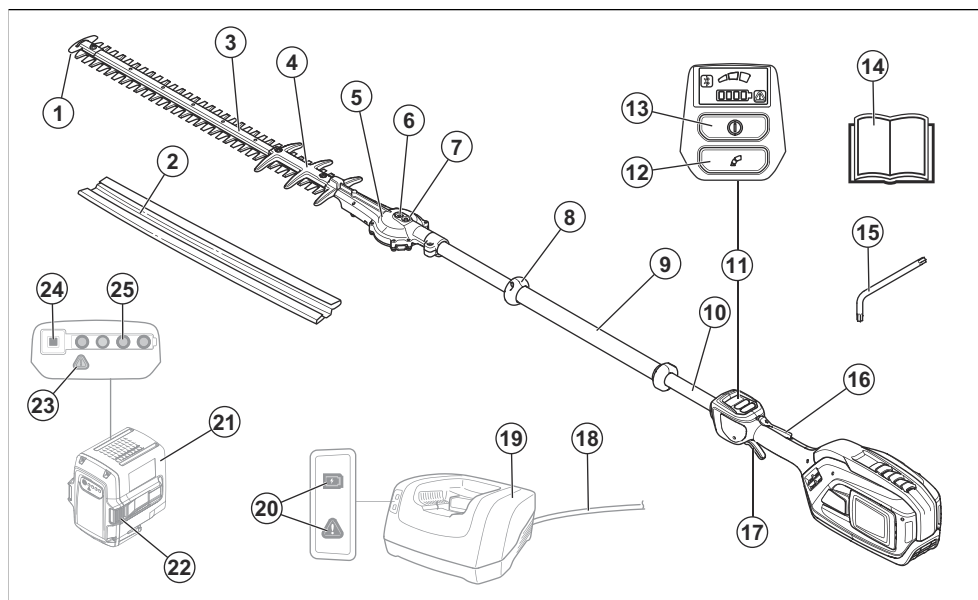

- | | |
|--|--|
| 1. Blade tip protection | 11. User interface |
| 2. Transport guard | 12. Speed mode button |
| 3. Cutting unit | 13. Start/stop button |
| 4. Blade guard | 14. Operator's manual |
| 5. Gear | 15. T27 Torx key |
| 6. Socket for manual release of the blades | 16. Power trigger lockout |
| 7. Grease nipple | 17. Power trigger |
| 8. Hand guard | 18. Power cord for the battery charger |
| 9. Front handle | 19. Battery charger |
| 10. Shaft | 20. Power on and warning LED |

- 21. Battery
- 22. Battery release buttons
- 23. Warning LED
- 24. Battery indicator button
- 25. LED indicator for the state of charge

Symbols on the product



WARNING: This product can be dangerous and cause serious injury or death to the operator or others. Be careful and use the product correctly.



Read the operator's manual carefully and make sure that you understand the instructions before you use this product.



Use a protective helmet in locations where objects can fall on you. Use approved hearing protection. Use approved eye protection.



Use stable boots with non-slip soles.



Use approved protective gloves.

V

Rated voltage, V



Direct current.

IPX4

The product has protection against splashing water.

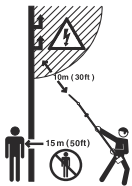

There is no electrical insulation in this product. If the product touches or comes near high voltage power lines, it can cause serious injury or death to the operator. Electricity can move between different objects by a curve. The higher the voltage, the longer the electricity can move. Electricity can also move through branches and other objects, especially if the object is wet. Always keep a distance at a minimum of 10 m/33 ft between the product and high voltage power lines and/or objects that touches the power lines. If it is necessary to do work near the power lines, make sure that the power is off before you start the work. Keep a distance at a minimum of 15 m/50 ft to other persons or animals during the operation.



If the product features Bluetooth® wireless technology. The Bluetooth® symbol will be marked on the product name label.



Disconnect battery before maintenance.



Stop the product fully before you touch the cutting tool.



Stop the product fully before you touch the cutting tool.



Noise emission to the environment label as per EU (also including New South Wales legislation) and UK directives and regulations. The guaranteed sound power level of the product is specified in *Technical data on page 18* and on the label.



The product agrees with the applicable EC directives.



This product conforms to the applicable UK regulations.



Symbols on the product or its packaging indicate that this product cannot be handled as domestic waste. This product must be deposited at an appropriate recycling facility.

yyyywwxxxx

The rating plate shows serial number. **yyyy** is the production year and **ww** is the production week.

Note: Other symbols/decals on the product refer to special certification requirements for some markets.

Safety

Safety definitions

Warnings, cautions and notes are used to point out specially important parts of the manual.



WARNING: Used if there is a risk of injury or death for the operator or bystanders if the instructions in the manual are not obeyed.



CAUTION: Used if there is a risk of damage to the product, other materials or the adjacent area if the instructions in the manual are not obeyed.

Note: Used to give more information that is necessary in a given situation.

General power tool safety warnings



WARNING: Read all safety warnings, instructions, illustrations and specifications provided with this power tool. Failure to follow all instructions listed below may result in electric shock, fire and/or serious injury.



WARNING: Make sure to read the approved accessory manual together with this power unit's manual.

Note: Save all warnings and instructions for future reference. The term "power tool" in the warnings refers to your mains-operated (corded) power tool or battery-operated (cordless) power tool.

Work area safety

- **Keep work area clean and well lit.** Cluttered or dark areas invite accidents.
- **Do not operate power tools in explosive atmospheres, such as in the presence of flammable liquids, gases or dust.** Power tools create sparks which may ignite the dust or fumes.
- **Keep children and bystanders away while operating a power tool.** Distractions can cause you to lose control.

Electrical safety

- **Power tool plugs must match the outlet. Never modify the plug in any way. Do not use any**

adapter plugs with earthed (grounded) power tools. Unmodified plugs and matching outlets will reduce risk of electric shock.

- **Avoid body contact with earthed or grounded surfaces, such as pipes, radiators, ranges and refrigerators.** There is an increased risk of electric shock if your body is earthed or grounded.
- **Do not expose power tools to rain or wet conditions.** Water entering a power tool will increase the risk of electric shock.
- **Do not abuse the cord. Never use the cord for carrying, pulling or unplugging the power tool. Keep cord away from heat, oil, sharp edges or moving parts.** Damaged or entangled cords increase the risk of electric shock.
- **When operating a power tool outdoors, use an extension cord suitable for outdoor use.** Use of a cord suitable for outdoor use reduces the risk of electric shock.
- **If operating a power tool in a damp location is unavoidable, use a residual current device (RCD) protected supply.** Use of a RCD reduces the risk of electric shock.

Personal safety

- **Stay alert, watch what you are doing and use common sense when operating a power tool. Do not use a power tool while you are tired or under the influence of drugs, alcohol or medication.** A moment of inattention while operating power tools may result in serious personal injury.
- **Use personal protective equipment. Always wear eye protection.** Protective equipment such as dust mask, non-skid safety shoes, hard hat or hearing protection used for appropriate conditions will reduce personal injuries.
- **Prevent unintentional starting. Ensure the switch is in the off-position before connecting to power source and/or battery pack, picking up or carrying the tool.** Carrying power tools with your finger on the switch or energising power tools that have the switch on invites accidents.
- **Remove any adjusting key or wrench before turning the power tool on.** A wrench or a key left attached to a rotating part of the power tool may result in personal injury.
- **Do not overreach. Keep proper footing and balance at all times.** This enables better control of the power tool in unexpected situations.
- **Dress properly. Do not wear loose clothing or jewellery. Keep your hair and clothing away from moving parts.** Loose clothes, jewellery or long hair can be caught in moving parts.

- **If devices are provided for the connection of dust extraction and collection facilities, ensure these are connected and properly used.** Use of dust collection can reduce dust-related hazards.
- **Do not let familiarity gained from frequent use of tools allow you to become complacent and ignore tool safety principles.** A careless action can cause severe injury within a fraction of a second.

Power tool use and care

- **Do not force the power tool. Use the correct power tool for your application.** The correct power tool will do the job better and safer at the rate for which it was designed.
- **Do not use the power tool if the switch does not turn it on and off.** Any power tool that cannot be controlled with the switch is dangerous and must be repaired.
- **Disconnect the plug from the power source and/or remove the battery pack, if detachable, from the power tool before making any adjustments, changing accessories, or storing power tools.** Such preventive safety measures reduce the risk of starting the power tool accidentally.
- **Store idle power tools out of the reach of children and do not allow persons unfamiliar with the power tool or these instructions to operate the power tool.** Power tools are dangerous in the hands of untrained users.
- **Maintain power tools and accessories. Check for misalignment or binding of moving parts, breakage of parts and any other condition that may affect the power tool's operation. If damaged, have the power tool repaired before use.** Many accidents are caused by poorly maintained power tools.
- **Keep cutting tools sharp and clean.** Properly maintained cutting tools with sharp cutting edges are less likely to bind and are easier to control.
- **Use the power tool, accessories and tool bits etc. in accordance with these instructions, taking into account the working conditions and the work to be performed.** Use of the power tool for operations different from those intended could result in a hazardous situation.
- **Keep handles and grasping surfaces dry, clean and free from oil and grease.** Slippery handles and grasping surfaces do not allow for safe handling and control of the tool in unexpected situations.

Battery tool use and care

- **Recharge only with the charger specified by the manufacturer.** A charger that is suitable for one type of battery pack may create a risk of fire when used with another battery pack.
- **Use power tools only with specifically designated battery packs.** Use of any other battery packs may create a risk of injury and fire.
- **When battery pack is not in use, keep it away from other metal objects, like paper clips, coins, keys, nails, screws or other small metal objects, that can**

make a connection from one terminal to another. Shorting the battery terminals together may cause burns or a fire.

- **Under abusive conditions, liquid may be ejected from the battery; avoid contact. If contact accidentally occurs, flush with water. If liquid contacts eyes, additionally seek medical help.** Liquid ejected from the battery may cause irritations or burns.
- **Do not use a battery pack or tool that is damaged or modified.** Damaged or modified batteries may exhibit unpredictable behavior resulting in fire, explosion or risk of injury.
- **Do not expose a battery pack or tool to fire or excessive temperature.** Exposure to fire or temperature above 130 °C (265 °F) may cause explosion.
- **Follow all charging instructions and do not charge the battery pack or tool outside the temperature range specified in the instructions.** Charging improperly or at temperatures outside the specified range may damage the battery and increase the risk of fire.

Service

- **Have your power tool serviced by a qualified repair person using only identical replacement parts.** This will ensure that the safety of the power tool is maintained.
- **Never service damaged battery packs.** Service of battery packs should only be performed by the manufacturer or authorized service providers.

Hedge trimmer safety warnings

- **Keep all parts of the body away from the blade. Do not remove cut material or hold material to be cut when blades are moving.** Blades continue to move after the switch is turned off. A moment of inattention while operating the hedge trimmer may result in serious personal injury.
- **Carry the hedge trimmer by the handle with the blade stopped and taking care not to operate any power switch.** Proper carrying of the hedge trimmer will decrease the risk of inadvertent starting and resultant personal injury from the blades.
- **When transporting or storing the hedge trimmer, always fit the blade cover.** Proper handling of the hedge trimmer will decrease the risk of personal injury from the blades.
- **When clearing jammed material or servicing the unit, make sure all power switches are off and the battery pack is removed or disconnected.** Unexpected actuation of the hedge trimmer while clearing jammed material or servicing may result in serious personal injury.
- **When clearing jammed material or servicing the unit, make sure all power switches are off and the lock-off is in the locked position.** Unexpected actuation of the hedge trimmer while clearing jammed material or servicing may result in serious personal injury.

- **Hold the hedge trimmer by insulated gripping surfaces only, because the blade may contact hidden wiring.** Blades contacting a "live" wire may make exposed metal parts of the hedge trimmer "live" and could give the operator an electric shock.
- **Keep all power cords and cables away from cutting area.** Power cords or cables may be hidden in hedges or bushes and can be accidentally cut by the blade.
- **Do not use the hedge trimmer in bad weather conditions, especially when there is a risk of lightning.** This decreases the risk of being struck by lightning.

Extended-reach hedge trimmer safety warnings

- **To reduce the risk of electrocution, never use the extended-reach hedge trimmer near any electrical power lines.** Contact with or use near power lines may cause serious injury or electric shock resulting in death.
- **Always use two hands when operating the extended-reach hedge trimmer.** Hold the extended-reach hedge trimmer with both hands to avoid loss of control.
- **Always use head protection when operating the extended-reach hedge trimmer overhead.** Falling debris can result in serious personal injury.

General safety instructions



WARNING: Read the warning instructions that follow before you use the product.

- Remove the battery to prevent the product from being started by accident.
- This product is a dangerous tool if you are not careful or if you use the product incorrectly. This product can cause serious injury or death to the operator or others.
- Do not use the product if it is changed from its initial specification. Do not change a part of the product without approval from the manufacturer. Only use parts that are approved by the manufacturer. Injury or death is a possible result of incorrect maintenance.
- Do a check of the product before use. See, *Safety devices on the product on page 8* and *Maintenance on page 14*. Do not use a product that is damaged or does not operate correctly. Do the safety checks, maintenance and service instructions described in this manual.
- Children should be supervised to ensure that they do not play with the product. Never allow children or other persons not trained in the use of the product and/or the battery to use or service it. Local laws may regulate the age of the user.
- Keep the product in a locked area to prevent access for children or persons that are not approved.
- Store the product out of reach of children.

- Under no circumstances may the design of the product be modified without the permission of the manufacturer. Always use original accessories. Non-authorized modifications and/or accessories can result in serious personal injury or the death of the operator and others.
- The vibration emission during actual use of the power tool can differ from the declared total value depending on the ways in which the tool is used. Operators should identify safety measures to protect themselves that are based on an estimation of exposure in the actual conditions of use (taking account of all parts of the operating cycle such as the times when the tool is switched off and when it is running idle in addition to the trigger).

Note: National or Local laws can regulate the use. Comply to given regulations.

Safety instructions for operation



WARNING: Read the warning instructions that follow before you use the product.

- If you encounter a situation where you are uncertain how to proceed you should ask an expert. Contact your dealer or your service workshop. Avoid all usage which you consider to be beyond your capability.
- Never use the product if you are fatigued, while under the influence of alcohol or drugs, medication or anything that could affect your vision, alertness, coordination or judgment.
- Working in bad weather is tiring and often brings added risk. Due to the added risk, it is not recommended to use the machine in very bad weather, for instance in dense fog, heavy rain, strong winds, intense cold, risk of lightning, etc.
- Faulty cutting attachment can increase the risk of accidents.
- Do not allow children to use or be in the vicinity of the product. Since the product is easy to start, children may be able to start it if they are not kept under full surveillance. This can mean a risk of serious personal injury. Disconnect the battery when the product is not under close supervision.
- Ensure that no people or animals come closer than 15 meters while you work. When several operators are working in the same area the safety distance should be at least 15 meters. Otherwise there is a risk of serious personal injury. Stop the product immediately if anyone approaches. Never swing the product around without first checking behind you to make sure that no one is within the safety zone.
- Ensure that people, animals or other things can not affect your control of the product or that they do not come in contact with the cutting attachment or loose objects that are thrown out by the cutting attachment. However, do not use the product unless

you are able to call for help in the event of an accident.

- Always inspect the working area. Remove all loose objects such as stones, broken glass, nails, steel wire, string, etcetera, that could be thrown out or become wrapped around the cutting attachment.
- Make sure that you can move and stand safely. Check the area around you for possible obstacles (roots, rocks, branches, ditches, etcetera) in case you have to move suddenly. Take great care when you work on sloping ground.
- Keep a good balance and a firm foothold at all times. Do not overreach.
- Deactivate the product before you move to another area. Attach the transport guard when the product is not in use.
- Never put the product down unless you have deactivated it. Do not leave the product unsupervised when it is switched on.
- Remove the battery before you pass the product to another person.
- Make sure that no clothes or parts of the body come in contact with the cutting attachment when the product is activated.
- If anything jams in the cutting attachment while you operate the product, stop and deactivate the product. Make sure that the cutting attachment stops completely. Remove the battery before you clean, inspect or repair the product and/or the cutting equipment.
- Keep your hands and feet away from the cutting attachment until it has stopped completely when the product is deactivated.
- Watch out for stumps of branches that can be thrown out when you cut. Do not cut too close to the ground where stones and other objects can be thrown out.
- Watch out for thrown objects. Always wear approved eye protection. Never lean over the cutting attachment guard. Stones, rubbish, etc., can be thrown up into the eyes which can cause blindness or serious injury.
- Listen out for warning signals or shouts when you wear hearing protection. Always remove your hearing protection as soon as the product stops.
- Never work from a ladder, stool or any other raised position that is not fully secured.
- This machine produces an electromagnetic field during operation. This field may under some circumstances interfere with active or passive medical implants. To reduce the risk of serious or fatal injury, we recommend persons with medical implants to consult their physician and the medical implant manufacturer before operating this machine.
- Always hold the product with both hands. Hold the product on the right side of your body.
- Always stop the product, remove the battery and make sure that the cutting equipment does not rotate before you remove material that is wound around the

blade shaft or caught between the guard and the cutting attachment.

- The electromagnetic field during operation can interfere with the active or passive medical implants. The persons with medical implants speak to your physician and the medical implant manufacturer before operating this product.
- Hold the weight of the product with the harness to make it easy to operate.
- Long-term exposure to noise can result in permanent hearing impairment. Husqvarna recommends that operators use approved hearing protection.
- Never use a product that has been modified in any way from its original specification.
- Never use a product that is faulty. Carry out the safety checks, maintenance and service instructions described in this manual. Some maintenance and service measures must be carried out by trained and qualified specialists. See instructions under the maintenance heading.
- Carry out an overall inspection of the product before use. See the maintenance schedule.
- Never allow anyone else to use the machine without first ensuring that they have read and understood the contents of the operator's manual.
- Check the working area for foreign objects such as electricity cables and animals, etc, or other objects that could damage the cutting attachment, such as metal items.
- Faulty blades can increase the risk of accidents.

Personal protective equipment



WARNING: Read the warning instructions that follow before you use the product.

- Always use approved personal protective equipment when you use the product. Personal protective equipment cannot fully prevent injury but it decreases the degree of injury if an accident does occur. Let your dealer help you select the right equipment.
- Use a protective helmet where there is a risk of falling objects.
- Long term exposure to noise can result in damaged hearing. In general, battery powered products are relatively quiet but damage can result from a combination of noise level and long usage. Husqvarna recommends that operators use hearing protectors when using products for a longer coherent time of a day. Continual and regular users should have their hearing checked regularly.



WARNING: Hearing protectors limit the ability to hear sounds and warning signals.

- Use approved eye protection. If you use a visor, you must also use approved protective goggles.

Approved protective goggles must comply with the ANSI Z87.1 standard in the USAs or EN 166 in EU countries.

- Use a visor for face protection. A visor is not enough for protection of the eyes.



- Use gloves when necessary, for example when you attach, examine or clean the cutting equipment.
- Use sturdy non-slip boots or shoes.
- Use clothing made of a strong fabric. Always use heavy, long pants and long sleeves. Do not use loose clothing that can catch on twigs and branches. Do not wear jewelry, short pants, sandals or go with bare feet. Put your hair up safely above shoulder level.



- Keep first aid equipment close at hand.

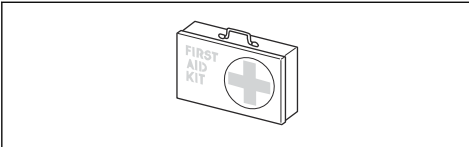

Safety devices on the product



WARNING: Read the warning instructions that follow before you use the product.

- Do not use a product with safety devices that are damaged or do not operate correctly.
- Do a check of the safety devices regularly. If the safety devices are damaged or do not operate correctly, speak to your Husqvarna service agent.
- Do not make modifications to safety devices.

To do a check of the user interface

1. Press and hold the start/stop button (A).

- a) The product is on when the display (B) comes on.

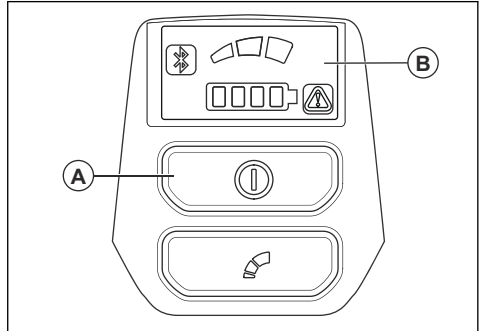

- b) The product is off when the display goes off.

2. If the warning indicator on the display is on or flashes, refer to *User interface on page 15*.

To do a check of the power trigger lockout

The power trigger lockout is designed to prevent accidental operation. When you push the power trigger lockout forward (A) and then press the power trigger lockout against the handle (B), the power trigger (C) is released. When you release the handle, the power trigger and the power trigger lockout both move back to their original positions. This movement is operated by three independent springs.

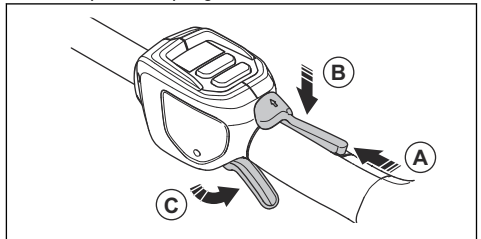

1. Make sure that the power trigger is locked when the lock is in its original position.

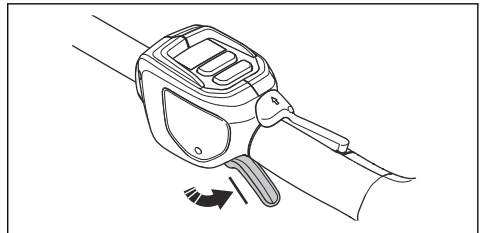

2. Push the power trigger lockout forward (A) and down. Hold the power trigger lockout against the handle (B) and make sure that it returns to its original position when you release it.

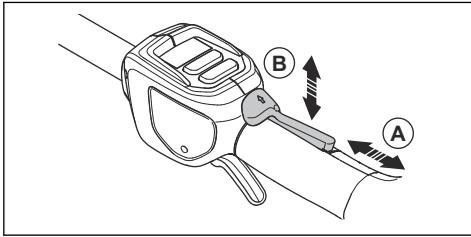

3. Make sure that the power trigger and the power trigger lockout moves freely and that the return springs operate properly.

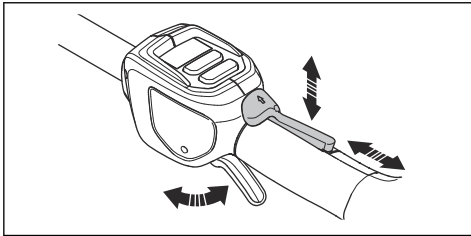

4. Start the product, refer to *To start the product on page 12*.
5. Push the power trigger fully to apply full speed.
6. Release the power trigger and make sure that the cutting attachment stops and remains still.

To do a check of the hand guard

The hand guard prevents hands from accidental contact with the blades.

1. Stop the product.
2. Remove the battery.
3. Check that the hand guard is attached correctly.
4. Examine the hand guard for damages.

To do a check of the bevel gear and gearbox



WARNING: To prevent burn injuries, let the product become cool before you touch the bevel gear and gearbox.

- Do a visual check for damage and deformation.

To do a check of the blades and blade guards

1. Stop the product.
2. Remove the battery.
3. Put on protective gloves.

4. Make sure that the blades (A) and blade guard (B) are not damaged or twisted. Replace the blades and blade guards if they are damaged or bent.

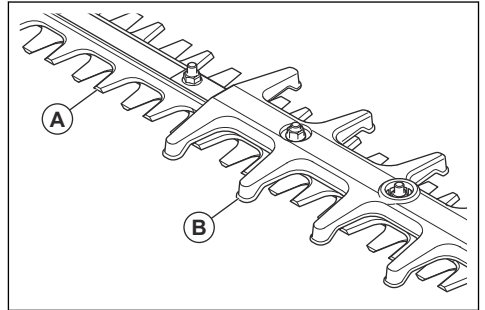

Battery safety



WARNING: Read the warning instructions that follow before you use the product.

- Only use the BLi200 or 40-B220X battery. Refer to *Approved batteries on page 19*. The battery is software encrypted.
- Use the BLi200 or 40-B220X battery that is rechargeable as a power supply for the related Husqvarna products only. To prevent injury, do not use the battery as a power supply for other devices.
- Risk of electrical shock. Do not connect the battery terminals to keys, coins, screws or other metal. This can cause a short circuit of the battery.
- Do not use non-rechargeable batteries.
- Do not put objects into the air slots of the battery.
- Keep the battery away from sunlight, heat or open flame. The battery can cause burns and/or chemical burns.
- Keep the battery away from rain and wet conditions.
- Keep the battery away from microwaves and high pressure.
- Do not try to disassemble or break the battery.
- If the battery leaks, do not let the liquid touch your body or eyes. If you have touched the liquid, clean the area with a large quantity of water and soap, and get medical aid. If you get liquid in your eyes, do not rub but flush with water for a minimum of 15 minutes and get medical aid.
- Use the battery in temperatures between -10 °C (14 °F) and 40 °C (114 °F).
- Do not clean the battery or the battery charger with water. Refer to *To clean the product, the battery and the battery charger on page 14*.
- Do not use a defective or damaged battery.
- Keep batteries in storage away from metal objects such as nails, screws or jewelry.
- Keep the battery away from children.

Battery charger safety



WARNING: Read the warning instructions that follow before you use the product.

- Risk of electrical shock or short circuit if the safety instructions are not obeyed.
- Do not use other battery chargers than the one supplied for your product. Only use Husqvarna chargers when you charge BLi200 replacement batteries.
- Do not try to disassemble the battery charger.
- Do not use a defective or damaged battery charger.
- Do not lift the battery charger by the power cord. To disconnect the battery charger from a mains socket, pull out the plug. Do not pull the power cord.
- Keep all cables and extension leads away from water, oil and sharp edges. Make sure that the cable is not caught between objects, for example, doors, fences or equivalent.
- Do not use the battery charger near flammable materials or materials that can cause corrosion. Make sure that the battery charger is not covered. Pull out the plug to the battery charger if there is smoke or fire.
- Only charge the battery indoors in a location with good airflow and away from sunlight. Do not charge the battery outdoors. Do not charge the battery in wet conditions.
- Only use the battery charger where the temperature is between 5 °C (41 °F) and 40 °C (104 °F). Use the charger in an environment which has a good airflow, dry and free from dust.
- Do not put objects into the cooling slots of the battery charger.
- Do not connect the battery charger terminals to metal objects as this can short circuit the battery charger.

- Use approved mains sockets that are not damaged. Make sure that the cord of the battery charger is not damaged. If extension cables are used, make sure that the extension cables are not damaged.

Safety instructions for maintenance



WARNING: Read the warning instructions that follow before you do maintenance on the product.

- Remove the battery before you do maintenance, other checks or assemble the product.
- The operator must only do the maintenance and servicing shown in this operator's manual. Turn to your servicing dealer for maintenance and servicing of a larger extension.
- Do not clean the battery or the battery charger with water. Strong detergent can cause damage to the plastic.
- If you do not do maintenance, it decreases the life cycle of the product and increases the risk of accidents.
- Special training is necessary for all servicing and repair work, especially for the safety devices on the product. If not all checks in this operator's manual are approved after you have done maintenance, turn to your servicing dealer. We guarantee that there are professional repairs and servicing available for your product.
- Keep the teeth of the blade correctly sharpened. Obey our recommendations. Also refer to the instructions on the blade package.
- Only use original spare parts.
- Always use heavy duty gloves when you repair the cutting attachment. The blades are very sharp and can easily cause injuries.

Assembly

Introduction



WARNING: Read and understand the safety chapter before you assemble the product.

To install the cutting unit

1. Loosen the screw on the cutting unit (A).

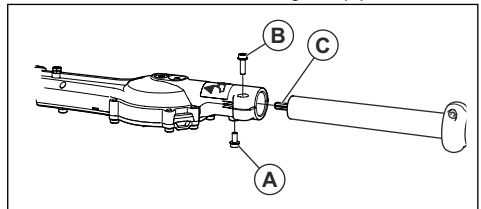

2. Put the shaft in the cutting unit. Align the screw (A) with the hole in the shaft.



CAUTION: Make sure that the drive shaft (C) engages with the gear in the cutting unit.

3. Tighten the screw (A) with your fingers. Make sure that screw (A) goes into the hole in the shaft.

4. Tighten the screw (A) fully.
5. Tighten the screw (B) fully.

Operation

Introduction



WARNING: Read and understand the safety chapter before you use the product.

To connect the battery charger

1. Connect the battery charger to the voltage and frequency that is specified on the rating plate.
2. Put the plug in a grounded socket outlet. The LED on the battery charger flashes green one time.

Note: The battery does not charge if the battery temperature is more than 50 °C/122 °F. If the temperature is more than 50 °C/122 °F, the battery charger makes the battery become cool before the battery charges.

To charge the battery

Note: Charge the battery if it is the first time that you use it. A new battery is only 30% charged.

1. Make sure that the battery is dry.
2. Put the battery in the battery charger.

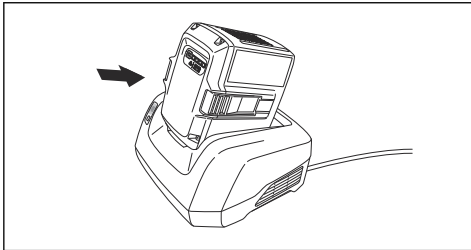

3. Make sure that the green charging light on the battery charger comes on. That means that the battery is connected correctly to the battery charger.

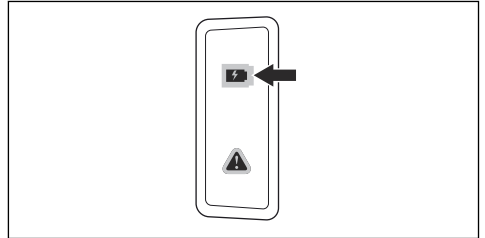

4. When all LEDs on the battery come on, the battery is fully charged.

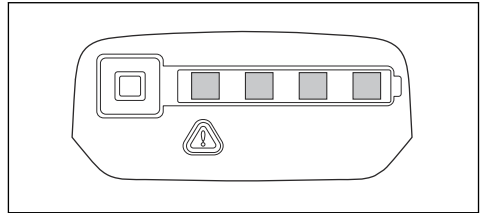

5. To disconnect the battery charger from the mains socket, pull the plug. Do not pull the cable.
6. Remove the battery from the battery charger.

Note: Refer to the battery and battery charger manuals for more information.

To connect the battery to the product



WARNING: Only use Husqvarna original batteries with the product.

1. Make sure that the battery is fully charged.

2. Push the battery into the battery holder of the product. The battery locks into position when you hear a click.

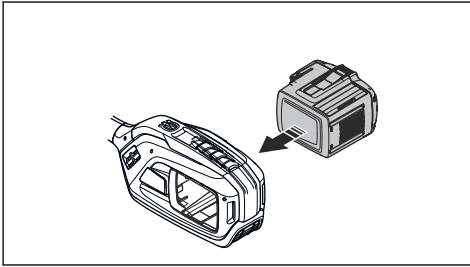

CAUTION: If the battery does not move easily into the battery holder, the battery is not installed correctly. This can cause damage to the product.

3. Make sure that the battery is installed correctly.

To do before you start the product

1. Examine the work area. Remove objects that can be thrown out.
2. Examine the cutting attachment. Make sure that the blades are sharp, and have no cracks and damages.
3. Make sure that the product works correctly. Examine that all nuts and screws are tight.
4. Make sure that the handle and safety devices are not damaged and are attached correctly. Do not operate a product with missing parts or is changed from its initial specification. Use protective gloves when it is necessary.
5. Make sure that the covers are not damaged and are attached correctly, before you operate the product.

To start the product

1. Put the product in the start position.
2. Push and hold the start button until the green LED comes on.

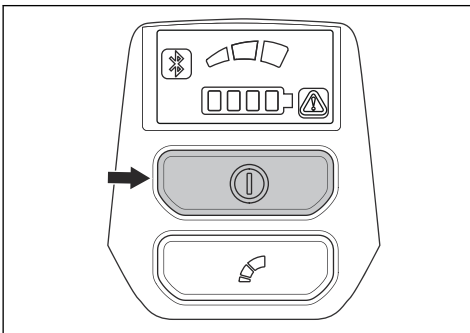

3. Use the power trigger to control the speed.

To limit the maximum speed with the mode button

The product has a mode button. With the mode button the operator can limit the maximum speed. The mode button has 3 speed levels. A lower level increases the time of operation for the product. Use level 1 and level 2 if the operation does not require full speed/full power. If the operation condition requires full speed/full power, use level 3. Do not use a higher level than necessary for the operation.

1. Push the mode button to set a limit to the maximum speed. The white LEDs comes on to show that the function is on.

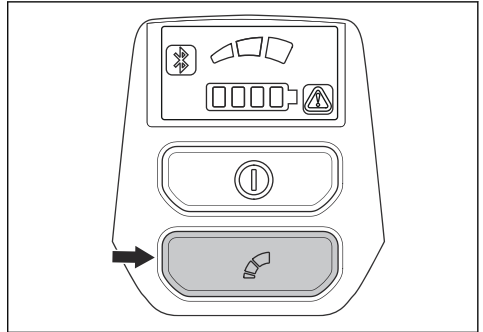

2. Push the Mode button again to choose the next speed level.

Automatic shutdown function

The product has an automatic shutdown function that stops the product if it is not used. The green LED for start/stop indication goes off and the product stops after 30 minutes.

To operate the product

1. Start near the ground and move the product up along the hedge when you cut the sides.

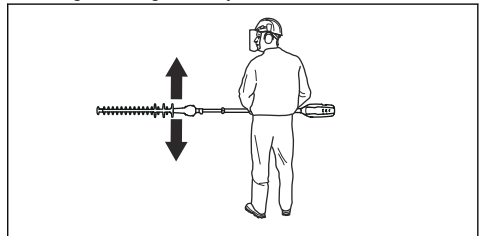

2. Adjust the speed to align with the work load.
3. Make sure that the motor does not touch the hedge.

4. Hold the product near your body for a stable work position.

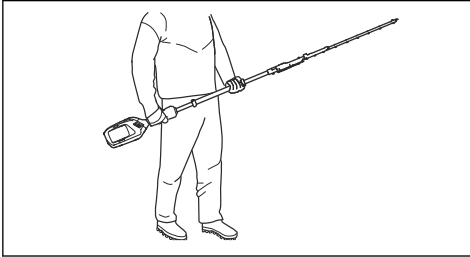

5. Make sure that the tip of the cutting equipment does not touch the ground.
6. Be careful and work slowly until all the branches are correctly cut.

To stop the product

1. Release the power trigger or the power trigger lockout.
2. Put the product in the stop position.
3. Push the stop button.

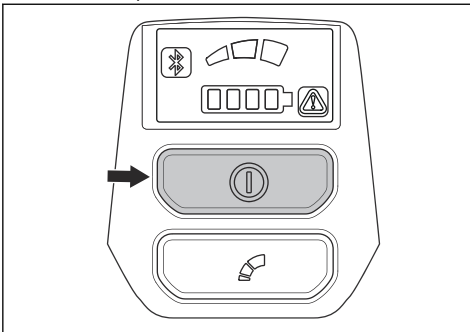

4. Push the release buttons on the battery and pull the battery out.

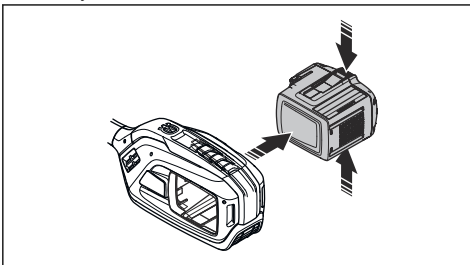

Husqvarna Fleet Services™

Husqvarna Fleet Services™ is a cloud solution that gives the commercial fleet manager an overview of all products. Husqvarna Fleet Services™ can be added to 525iHF3. For more information about Husqvarna Fleet Services™, refer to www.husqvarna.com.

Bluetooth® wireless technology

Products with built-in Bluetooth® wireless technology can connect to mobile devices and enables additional functions.

The symbol for *Bluetooth®* wireless technology comes on when your mobile device is connected to the product.



To connect to the product with Husqvarna Fleet Services™

1. Download the Husqvarna Fleet Services™ app to your mobile device.
2. Log on to the Husqvarna Fleet Services™ app.
3. Follow the instructions about how to pair the product with Husqvarna Fleet Services™.

Maintenance

Introduction



WARNING: Before you do any maintenance work you must read and understand the safety chapter.

Maintenance schedule



WARNING: Remove the battery before you do maintenance.

Maintenance	Before use	Weekly	Monthly
Clean the external parts of the product.	X		
Examine that the start and stop switch works correctly and is not damaged.	X		
Make sure that the power trigger and the power trigger lockout function correctly from a safety point of view.	X		
Make sure that all controls work and are not damaged.	X		
Make sure that the cutter blade and cutter guard have no cracks and that they are not damaged. Replace the cutter blade or the cutter guard if they have cracks or if they are hit.	X		
Make sure that the cutter blade is not bent. Replace the cutter blade if it is bent.	X		
Make sure that the hand guard is not damaged. Replace the guard if it is damaged.	X		
Make sure that the screws and nuts are tight.	X		
Make sure that the battery is not damaged.	X		
Make sure that the battery is charged.	X		
Make sure that the battery charger is not damaged.	X		
Make sure that the position lock of the cutting deck is not damaged and operates correctly.	X		
Make sure that the screws that hold the cutter blades together are correctly tightened.		X	
Do a check of the connections between the battery and the product. Do a check of the connection between the battery and the battery charger.			X

To examine the battery and the battery charger

1. Examine the battery for damages, for example cracks.
2. Examine the battery charger for damages, for example cracks.
3. Make sure that the connection cord of the battery charger is not damaged and that there are no cracks in it.

To clean the product, the battery and the battery charger

1. Clean the product with a dry cloth after use.

2. Clean the battery and battery charger with a dry cloth. Keep the battery guide tracks clean.
3. Make sure that the terminals on the battery and the battery charger are clean before the battery is put in the battery charger or the product.

To clean and lubricate the blades

1. Clean the blades from unwanted materials before and after you use the product.
2. Lubricate the blades before long periods of storage.

Note: Speak to your servicing dealer for more information about recommended cleaning agents and lubricants.

To lubricate the gear housing



WARNING: Do not touch the gear housing immediately after operation of the product. The gear housing is hot and can cause injury.

- Use Husqvarna special grease. Speak to your servicing dealer for more information about recommended grease.
- Add the grease through the grease nipple.

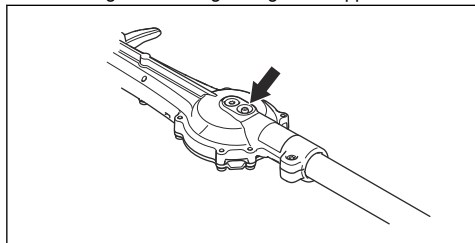

CAUTION: Do not fill the gear housing fully.

To examine the blades

1. Remove the cap on the socket of the gear housing.
2. Put the T27 torx key in the socket of the gear housing and turn clockwise and counterclockwise. Make sure that the blades move freely.

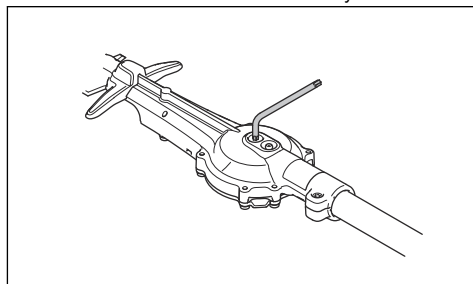

3. Examine the edges of the blades for damages and deformation.
4. Use a file to remove burrs on the blades.

Troubleshooting

Blade

Problem	Possible causes	Recommended step
The blade moves slowly or does not move.	The blade is blocked or it is damaged.	Clean the blades from unwanted materials. Refer to <i>To clean and lubricate the blades on page 14</i> . Remove burrs from the blade, refer to <i>To examine the blades on page 15</i> . Replace the blade if it is damaged.
The blade does not cut easily.	The blade is not sharp or it is damaged.	Sharpen the blade, refer to <i>To examine the blades on page 15</i> . Replace the blade if it is damaged.
The blade becomes hot.	There is friction between the blades.	Remove burrs from the blade and lubricate the blade. Refer to <i>To clean and lubricate the blades on page 14</i> .

User interface

Problem	Possible faults	Possible action
Battery LED indicator flashes orange	Low battery voltage.	Charge the battery.

Problem	Possible faults	Possible action
Error LED flashes red	Overload.	The cutting attachment is jammed. Stop the product. Remove the battery. Clean the cutting attachment from unwanted materials.
	Temperature deviation.	Let the product cool down.
	The power trigger and the activate button are pressed at the same time.	Release the power trigger and the product is active.
The product does not start	Dirt in the battery connectors.	Clean the battery connectors with compressed air or a soft brush.
Error LED is lit with red light	The product needs servicing.	Contact your servicing agent.

Battery

Problem	Possible faults	Possible solution
Green LED flashes.	Low battery voltage.	Charge the battery.
Red error LED flashes.	The battery is empty.	Charge the battery.
	Temperature deviation.	Use the battery in temperatures between -10°C (14°F) and 40°C (104°F).
	Overvoltage.	Remove the battery from the battery charger.
Red error LED comes on.	Cell difference is too much (1V).	Speak to your servicing dealer.

Battery charger

Problem	Possible faults	Possible solution
Red error LED flashes.	Temperature deviation.	Use the battery charger in temperatures between 5 °C (41 °F) and 40 °C (104 °F).
Red error LED comes on.		Speak to your servicing dealer.

Transportation, storage and disposal

Transportation and storage

- The supplied Li-ion batteries obey the Dangerous Goods Legislation requirements.
 - Obey the special requirement on package and labels for commercial transportation, including by third parties and forwarding agents.
 - Speak to a person with special training in dangerous material before you send the product. Obey all applicable national regulations.
- Use tape on open contacts when you put the battery in a package. Put the battery in the package tightly to prevent movement.
 - Remove the battery for storage or transportation.
 - Put the battery and the battery charger in a space that is dry and free from moisture and frost.
 - Do not keep the battery in an area where static electricity can occur. Do not keep the battery in a metal box.

- Put the battery in storage where the temperature is between 5°C/41°F and 25°C/77°F and away from open sunlight.
- Put the battery charger in storage where the temperature is between 5 °C/41 °F and 45°C/113°F and away from open sunlight.
- Use the battery charger only when the surrounding temperature is between 5°C/41°F and 40°C/104°F.
- Charge the battery 30% to 50% before you put it in storage for long periods.
- Put the battery charger in storage in a space that is closed and dry.
- Keep the battery away from the battery charger during storage. Do not let children and other not approved persons to touch the equipment. Keep the equipment in a space that you can lock.
- Clean the product and do a full servicing before you put the product in storage for a long time.
- Use the transportation guard on the product to prevent injuries or damage on the product during transportation and storage.
- Attach the product safely during transportation.

Disposal of the battery, battery charger and product

Symbols on the product or the package of the product means that the product is not domestic waste. Recycle it at a recycling station for electrical and electronic equipment. This helps to prevent damage to the environment and to persons.

Get in touch with your local authorities, domestic waste service or your dealer for more information about how to recycle your product.

Technical data

Technical data

	525iHF3
Motor	
Motor type	Husqvarna E-torq BLDC
Speed of output shaft, 1/min	5800
Weight	
Weight without battery, kg/lb	5.7/12.6
Weight including battery BLi200, kg/lb	7.1/15.7
Blades	
Type	Double sided
Cutting length, inch/mm	25.5/650
Cutting speed, cuts/min	4200
Noise emissions ¹	
Sound power level, measured dB (A)	90
Sound power level, guaranteed L_{WA} dB (A)	92
Sound levels ²	
Equivalent sound pressure level at the operator's ear, measured according to ISO 22868, dB(A)	81
Vibration levels ³	
Equivalent vibration levels ($a_{hv,eq}$) at handles, measured according to ISO 22867, m/s^2 :	
Front/Rear, m/s^2	4.7/4.4

Radio frequency data

	525iHF3
Frequency range, GHz	2.4-2.4835

¹ Noise emissions in the environment measured as sound power (L_{WA}) in conformity with EC directive 2000/14/EC. Reported sound power level for the product has been measured with the original cutting attachment that gives the highest level. The difference between guaranteed and measured sound power is that the guaranteed sound power also includes dispersion in the measurement result and the variations between different products of the same model according to Directive 2000/14/EC.

² Reported data for equivalent sound pressure level has a typical statistical dispersion (standard deviation) of 1 dB(A).

³ Reported data for equivalent vibration level has a typical statistical dispersion (standard deviation) of 1 m/s^2 .

	525iHF3
Output power ⁴ , max dBm	0

Approved batteries

Battery	BLI200	40-B220X
Type	Lithium-ion	Lithium-ion
Battery capacity, Ah	5.2	6.0
Nominal voltage, V	36	36
Weight, kg (lb)	1.3 (2.9)	1.4 (3.1)

Approved battery chargers

Battery charger	QC330
Input voltage, V	100-240
Frequency, Hz	50-60
Power, W	330

Registered trademarks

The *Bluetooth*[®] word mark and logos are registered trademarks owned by *Bluetooth SIG, inc.* and any use of such marks by Husqvarna is under license.

⁴ Measured at 2440 MHz.

Declaration of Conformity

EU Declaration of Conformity

We, **Husqvarna AB**, SE-561 82 Huskvarna, Sweden, tel: +46-36-146500, declare on our sole responsibility that the product:

Description	Battery-operated extended reach Hedge Trimmer
Brand	Husqvarna
Type / Model	525iHF3
Identification	Serial numbers dating from 2023 and onwards

complies fully with the following EU directives and regulations:

Directive/Regulation	Description
2006/42/EC	"relating to machinery"
2014/30/EU	"relating to electromagnetic compatibility"
2014/53/EU*	"relating to radio equipment"
2011/65/EU	"on the restriction of hazardous substances"
2000/14/EC	"relating to outdoor noise"

and that the following standards and/or technical specifications are applied: EN 62841-1:2015, EN 62841-4-2:2019 +A1:2022 +A11:2022, EN 61000-6-1:2007 (Immunity), EN 61000-6-3:2007/A1:2011/AC:2012 (Emission), ETSI EN 301 489-17 v.3.1.1*, ETSI EN 301 489-1 v.2.2.3*, ETSI 300 328 v.2.2.2*, EN IEC 63000:2018

*Applicable for versions that include Bluetooth communication

SMP Svensk Maskinprovning AB, Box 4053, SE-904 03 Umeå, Sweden has performed a voluntary type examination according to annex IX of 2006/42/EC. Certificate No: SEC/23/2589

SMP Svensk Maskinprovning AB has also verified agreement with annex V of the council's directive 2000/14/EC.

Huskvarna, 2023-11-20

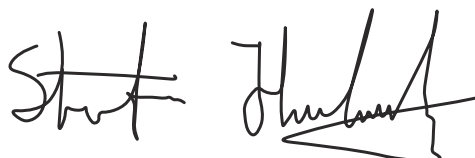

Mr. Stefan Holmberg
R&D Director, Technology Management

Husqvarna AB

Responsible for technical documentation



Declaration of Conformity

We, **Husqvarna AB**, SE-561 82 Huskvarna, Sweden, tel: +46-36-146500, declare on our sole responsibility that the product:

Description	Battery-operated extended reach Hedge Trimmer
Brand	Husqvarna
Type / Model	525iHF3
Identification	Serial numbers dating from 2023 and onwards

complies fully with the following UK regulations:

Description
The Supply of Machinery (Safety) Regulations 2008
Electromagnetic Compatibility Regulations 2016
Radio Equipment Regulations 2017*
The Restriction of the Use of Certain Hazardous Substances in Electrical and Electronic Equipment Regulations 2012
The Noise Emission in the Environment by Equipment for use Outdoors Regulations 2001

and that the following standards and/or technical specifications are applied: EN 62841-1:2015, EN 62841-4-2:2019 +A1:2022 +A11:2022, EN 61000-6-1:2007 (Immunity), EN 61000-6-3:2007/ A1:2011/AC:2012 (Emission), ETSI EN 301 489-17 v.3.1.1*, ETSI EN 301 489-1 v.2.2.3*, ETSI 300 328 v.2.2.2*, EN IEC 63000:2018

*Applicable for versions that include Bluetooth communication

SMP Svensk Maskinprovning AB, Box 4053, SE-904 03 Umeå, Sweden has performed a voluntary type examination according to annex IX of 2006/42/EC. Certificate No: SEC/23/2589

SMP Svensk Maskinprovning AB has also verified agreement with annex V of the council's directive 2000/14/EC.

Huskvarna, 2023-11-20

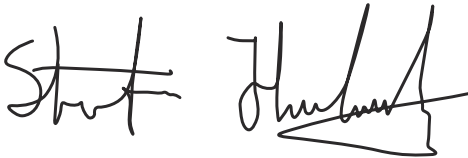

Mr. Stefan Holmberg
R&D Director, Technology Management
Husqvarna AB
Responsible for technical documentation



UK Importer:
Husqvarna UK Ltd
Preston Road, Co. Durham
DL5 6UP

Husqvarna®

www.husqvarna.com

Original instructions



1143732-26



2024-02-20