



Husqvarna[®]



T540i XP[®], T540i XPG[®]

Contents

Introduction.....	2	Transportation, storage and disposal.....	27
Safety.....	4	Technical data.....	28
Assembly.....	12	Accessories.....	29
Operation.....	14	Declaration of Conformity.....	31
Maintenance.....	19	Registered trademarks.....	33
Troubleshooting.....	27		

Introduction

Intended use

This product is for professional tree maintenance such as pruning and to disassemble trees in sections.

Note: National regulations can set limit to the operation of the product.

Product description

This product is a chainsaw model with an electric motor.

Work is constantly in progress to increase your safety and efficiency during operation. Speak to your servicing dealer for more information.

Product overview

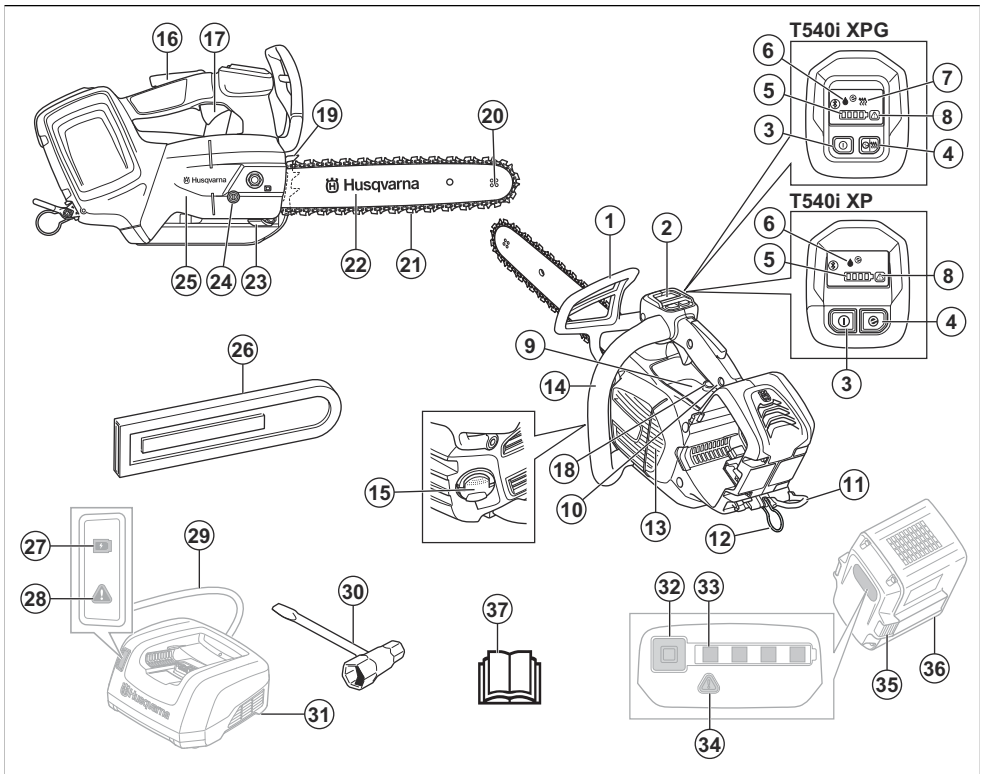

- | | |
|------------------------------------|----------------------|
| 1. Front handguard and chain brake | 3. Start/stop button |
| 2. User interface | 4. SavE button |

5. Battery indicator
6. Oil level indicator
7. Indicator for heat in the handles
8. Warning indicator
9. Information and warning decal
10. Top handle
11. Belt eyelet
12. Rope eyelet
13. Fan housing
14. Front handle
15. Chain oil tank
16. Power trigger lockout
17. Power trigger
18. Oil adjustment screw
19. Spiked bumper
20. Bar tip sprocket
21. Saw chain
22. Guide bar
23. Chain catcher
24. Chain tensioning screw
25. Drive sprocket cover
26. Guide bar cover
27. Indicator for state of charge
28. Warning indicator
29. Power cord
30. Combination wrench
31. Battery charger (accessory)
32. Button, battery status
33. Battery status
34. Warning indicator
35. Battery release button
36. Battery (accessory)
37. Operator's manual

Symbols on the product



Risk of serious injury or death to the operator or others. Be careful and use the product correctly. Read the operator's manual carefully and understand the instructions before operation of the product.



Use approved protective helmet, hearing protection and eye protection.



This product complies with applicable EC Directives.



This product conforms to the applicable UK regulations.



Noise emission to the environment label as per EU (also including New South Wales legislation) and UK directives and regulations. The guaranteed sound power level of the product is specified in *Declaration of Conformity on page 31* and on the label.



Use approved protection for feet, legs, hands and arms.



Use 2 hands when you operate the product.



Warning! Kickback can occur when the guide bar tip touches an object. This causes the guide bar to be thrown in the direction of the operator. Risk of serious injury or death.



Chain brake, engaged (right). Chain brake, disengaged (left).



Indication of chain direction.



Maximum length of the guide bar.



Chain oil.



Rated voltage, V.



Direct current.



Protected against splashing water.



Environmental mark. The product or package of the product is not domestic waste. Recycle it at an approved disposal location for electrical and electronic equipment.



If the product features *Bluetooth*[®] wireless technology. The Bluetooth[®] symbol will be marked on the product name label. Refer to *Bluetooth*[®] wireless technology on page 14.



This saw should only be used by persons who are specially trained in tree maintenance work. See operator's manual!

yyyywwxxxxx

The rating plate or the laser printing shows the serial number. **yyyy** is the production year, **ww** is the production week.

Note: Other symbols/decals on the product refer to certification requirements for some markets.

Symbol in the manual

The symbol that follows is only used in illustrations of this operator's manual.



Warning! Kickback can occur when the guide bar tip touches an object. This causes the guide bar to be thrown in the

direction of the operator. Risk of serious injury or death.

Symbols on the battery and/or on the battery charger



Recycle this product at a recycling station for electrical and electronic equipment. (Applies to Europe only)



Fail-safe transformer.



Use and keep the battery charger indoors only.



Double insulation.

Product damage

We are not responsible for damages to our product if:

- the product is incorrectly repaired.
- the product is repaired with parts that are not from the manufacturer or not approved by the manufacturer.
- the product has an accessory that is not from the manufacturer or not approved by the manufacturer.
- the product is not repaired at an approved service center or by an approved authority.

Safety

Safety definitions

Warnings, cautions and notes are used to point out specially important parts of the manual.



WARNING: Used if there is a risk of injury or death for the operator or bystanders if the instructions in the manual are not obeyed.



CAUTION: Used if there is a risk of damage to the product, other materials or the adjacent area if the instructions in the manual are not obeyed.

Note: Used to give more information that is necessary in a given situation.

General machine safety warnings



WARNING: Read all safety warnings, instructions, illustrations and specifications provided with this machine. Failure to follow all instructions listed below may result in electric shock, fire and/or serious injury.

- **Save all warnings and instructions for future reference.** The term "machine" in the warnings refers to your mains-operated (corded) machine or battery-operated (cordless) machine.

Work area safety

- **Keep work area clean and well lit.** Cluttered or dark areas invite accidents.
- **Do not operate machines in explosive atmospheres, such as in the presence of flammable liquids, gases or dust.** Machines create sparks which may ignite the dust or fumes.
- **Keep children and bystanders away while operating a machine.** Distractions can cause you to lose control.

Electrical safety

- **Machine plugs must match the outlet. Never modify the plug in any way. Do not use any adapter plugs with earthed (grounded) machines.** Unmodified plugs and matching outlets will reduce risk of electric shock.
- **Avoid body contact with earthed or grounded surfaces, such as pipes, radiators, ranges and refrigerators.** There is an increased risk of electric shock if your body is earthed or grounded.
- **Do not expose machines to rain or wet conditions.** Water entering a machine will increase the risk of electric shock.
- **Do not abuse the cord. Never use the cord for carrying, pulling or unplugging the machine. Keep cord away from heat, oil, sharp edges or moving parts.** Damaged or entangled cords increase the risk of electric shock.
- **When operating a machine outdoors, use an extension cord suitable for outdoor use.** Use of a cord suitable for outdoor use reduces the risk of electric shock.
- **If operating a machine in a damp location is unavoidable, use a residual current device (RCD) protected supply.** Use of a RCD reduces the risk of electric shock.

Personal safety

- **Stay alert, watch what you are doing and use common sense when operating a machine. Do not use a machine while you are tired or under the influence of drugs, alcohol or medication.** A moment of inattention while operating machines may result in serious personal injury.
- **Use personal protective equipment. Always wear eye protection.** Protective equipment such as dust mask, non-skid safety shoes, hard hat or hearing protection used for appropriate conditions will reduce personal injuries.
- **Prevent unintentional starting. Ensure the switch is in the off-position before connecting to power source and/or battery pack, picking up or carrying the tool.** Carrying machines with your finger on the switch or energising machines that have the switch on invites accidents.
- **Remove any adjusting key or wrench before turning the machine on.** A wrench or a key left attached to

a rotating part of the machine may result in personal injury.

- **Do not overreach. Keep proper footing and balance at all times.** This enables better control of the machine in unexpected situations.
- **Dress properly. Do not wear loose clothing or jewellery. Keep your hair and clothing away from moving parts.** Loose clothes, jewellery or long hair can be caught in moving parts.
- **If devices are provided for the connection of dust extraction and collection facilities, ensure these are connected and properly used.** Use of dust collection can reduce dust-related hazards.
- **Do not let familiarity gained from frequent use of tools allow you to become complacent and ignore tool safety principles.** A careless action can cause severe injury within a fraction of a second.

Machine use and care

- **Do not force the machine. Use the correct machine for your application.** The correct machine will do the job better and safer at the rate for which it was designed.
- **Do not use the machine if the switch does not turn it on and off.** Any machine that cannot be controlled with the switch is dangerous and must be repaired.
- **Disconnect the plug from the power source and/or remove the battery pack, if detachable, from the machine before making any adjustments, changing accessories, or storing machines.** Such preventive safety measures reduce the risk of starting the machine accidentally.
- **Store idle machines out of the reach of children and do not allow persons unfamiliar with the machines or these instructions to operate the machines.** Machines are dangerous in the hands of untrained users.
- **Maintain machines and accessories. Check for misalignment or binding of moving parts, breakage of parts and any other condition that may affect the machines's operation. If damaged, have the machine repaired before use.** Many accidents are caused by poorly maintained machines.
- **Keep cutting tools sharp and clean.** Properly maintained cutting tools with sharp cutting edges are less likely to bind and are easier to control.
- **Use the machine, accessories and tool bits etc. in accordance with these instructions, taking into account the working conditions and the work to be performed.** Use of the machine for operations different from those intended could result in a hazardous situation.
- **Keep handles and grasping surfaces dry, clean and free from oil and grease.** Slippery handles and grasping surfaces do not allow for safe handling and control of the tool in unexpected situations.

Battery tool use and care

- **Recharge only with the charger specified by the manufacturer.** A charger that is suitable for one type of battery pack may create a risk of fire when used with another battery pack.
- **Use machines only with specifically designated battery packs.** Use of any other battery packs may create a risk of injury and fire.
- **When battery pack is not in use, keep it away from other metal objects, like paper clips, coins, keys, nails, screws or other small metal objects, that can make a connection from one terminal to another.** Shorting the battery terminals together may cause burns or a fire.
- **Under abusive conditions, liquid may be ejected from the battery; avoid contact. If contact accidentally occurs, flush with water. If liquid contacts eyes, additionally seek medical help.** Liquid ejected from the battery may cause irritations or burns.
- **Do not use a battery pack or tool that is damaged or modified.** Damaged or modified batteries may exhibit unpredictable behaviour resulting in fire, explosion or risk of injury.
- **Do not expose a battery pack or tool to fire or excessive temperature.** Exposure to fire or temperature above 130 °C / 265 °F may cause explosion.
- **Follow all charging instructions and do not charge the battery pack or tool outside the temperature range specified in the instructions.** Charging improperly or at temperatures outside the specified range may damage the battery and increase the risk of fire.

Service

- **Have your machine serviced by a qualified repair person using only identical replacement parts.** This will ensure that the safety of the machine is maintained.
- **Never service damaged battery packs.** Service of battery packs should only be performed by the manufacturer or authorized service providers.

General chain saw safety warnings

- **Keep all parts of the body away from the saw chain when the chain saw is operating. Before you start the chain saw, make sure the saw chain is not contacting anything.** A moment of inattention while operating chain saws may cause entanglement of your clothing or body with the saw chain.
- **Always hold the chain saw with your right hand on the top handle and your left hand on the front handle.** Holding the chain saw with a reversed hand configuration increases the risk of personal injury and should never be done.
- **Hold the chain saw by insulated gripping surfaces only, because the saw chain may contact hidden wiring.** Saw chains contacting a "live" wire may make

exposed metal parts of the chain saw "live" and could give the operator an electric shock.

- **Wear eye protection. Further protective equipment for hearing, head, hands, legs and feet is recommended.** Adequate protective equipment will reduce personal injury from flying debris or accidental contact with the saw chain.
- **Do not operate a chain saw on a ladder, from a rooftop, or any unstable support.** Operation of a chain saw in this manner could result in serious personal injury.
- **When cutting a limb that is under tension, be alert for spring back.** When the tension in the wood fibres is released, the spring loaded limb may strike the operator and/or throw the chain saw out of control.
- **Carry the chain saw by the front handle with the chain saw switched off and away from your body. When transporting or storing the chain saw, always fit the guide bar cover.** Proper handling of the chain saw will reduce the likelihood of accidental contact with the moving saw chain.
- **Follow instructions for lubricating, chain tensioning and changing the bar and chain.** Improperly tensioned or lubricated chain may either brake or increase the chance for kickback.
- **Cut wood only. Do not use chain saw for purposes not intended. For example: do not use chain saw for cutting metal, plastic, masonry or non-wood building materials.** Use of the chain saw for operations different than intended could result in a hazardous situation.
- **This chain saw is not intended for tree felling.** Use of the chain saw for operations different than intended could result in serious injury to the operator or bystanders.
- **Follow all instructions when clearing jammed material, storing or servicing the chain saw. Make sure the switch is off and the battery pack is removed.** Unexpected actuation of the chain saw while clearing jammed material or servicing may result in serious personal injury.

Causes and operator prevention of kickback

Kickback may occur when the nose or tip of the guide bar touches an object, or when the wood closes in and pinches the saw chain in the cut. Tip contact in some cases may cause a sudden reverse reaction, kicking the guide bar up and back towards the operator. Pinching the saw chain along the top of the guide bar may push the guide bar rapidly back towards the operator. Either of these reactions may cause you to lose control of the saw which could result in serious personal injury. Do not rely exclusively upon the safety devices built into your saw. As a chain saw user, you should take several steps to keep your cutting jobs free from accident or injury. Kickback is the result of chain saw misuse and/or incorrect operating procedures or conditions and can be avoided by taking proper precautions as given below:

- **Maintain a firm grip, with thumbs and fingers encircling the chain saw handles, with both hands**

on the saw and position your body and arm to allow you to resist kickback forces. Kickback forces can be controlled by the operator, if proper precautions are taken. Do not let go of the chain saw.

- **Do not overreach and do not cut above shoulder height.** This helps prevent unintended tip contact and enables better control of the chain saw in unexpected situations.
- **Only use replacement guide bars and saw chains specified by the manufacturer.** Incorrect replacement guide bars and saw chains may cause chain breakage and/or kickback.
- **Follow the manufacturer's sharpening and maintenance instructions for the saw chain.**
Decreasing the depth gauge height can lead to increased kickback.

SAVE THESE INSTRUCTIONS.

General safety instructions



WARNING: Read the warning instructions that follow before you use the product.

- This product is a dangerous tool if you are not careful or if you use the product incorrectly. This product can cause serious injury or death to the operator or others. It is very important that you read and understand the contents of this operator's manual.
 - Do not change the product without an approval from the manufacturer. Do not use a product that has been changed by others and always use original accessories. Changes that are not approved from the manufacturer can result in serious injury or death to the operator or others.
 - Long term inhalation of chain oil fumes and sawdust can cause health problems.
 - This product produces an electromagnetic field during operation. This field may under some circumstances interfere with active or passive medical implants. To decrease the risk of serious injury or death, we recommend persons with medical implants to turn to their physician and the medical implant manufacturer before operating this product.
- This product has an increased risk of losing control. Only persons who have special training in cutting and working technique must operate this product in a tree. The operator must have safety equipment such as a lift, ropes and safety harness. Regular chainsaws are recommended for all work at ground level.
 - Follow instructions on special cutting and working techniques to decrease the risk of injury. Do not do work in a tree unless you have professional training for such work. This training includes safe climbing techniques and work positions. You must learn how to use equipment such as harnesses, ropes, belts, climbing irons and carabiners.
 - Do not cut with the kickback zone at the guide bar tip.
 - Do not touch a rotating saw chain. It can cause serious injuries or death.
 - Do not try to catch falling sections or make cuts if the operator is only attached with one rope. Always use two safety ropes.
 - During felling operations, lift your hearing protection immediately when the sawing is complete. It is important that you hear sounds and warning signals.
 - You must understand the effects of kickback and how to prevent them before you use this product. Refer to *Kickback information on page 15* and *Common questions about kickback on page 15* for instructions.
 - Do not use a product, battery or battery charger that is damaged or does not operate correctly.
 - Do not use the product if you are tired, ill or while under the influence of alcohol, drugs or medicine. Do not use the product if you are in a condition that can have a negative effect on your vision, alertness, coordination or judgment. The risk of being tired increases before the end of a work period.
 - Do not start a product unless the guide bar, saw chain and all covers are assembled correctly. If not, the drive sprocket can come loose and cause serious injuries. Refer to *Assembly on page 12* for instructions.
 - Sometimes chips get stuck in the clutch cover causing the saw chain to jam. Always stop the engine before cleaning.

Safety instructions for operation



WARNING: Read the warning instructions that follow before you use the product.

- The information in this operator's manual not an alternative to professional knowledge and experience. If you do not feel sure about how to operate this product, turn to a person with professional knowledge and experience.
- Turn to your servicing dealer or Husqvarna if you have questions about the operation of the

- Make sure that there is no risk that persons or animals touch or influence on your control of the product.

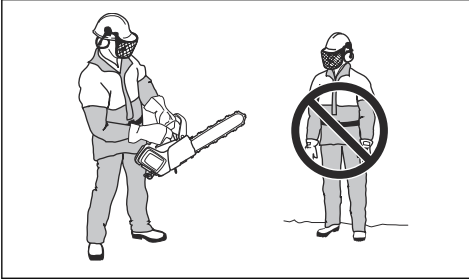

- If you are not careful, the risk of kickback increases. A kickback can occur if the kickback zone of the guide bar accidentally touches a branch, tree or other objects.
- Do not hold the product with one hand. This product is not safely controlled with one hand.
- Hold the product tightly with your right hand on the top handle and your left hand on the front handle. Put your fingers and thumbs around the handles. This decreases the effect of kickback and lets you keep control of the product. Do not let go of the handles!

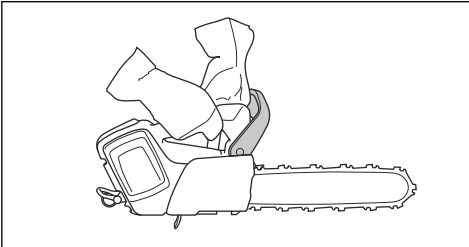

- Make sure that you have stable feet and that the saw chain does not touch an object.
- Do not use the product above shoulder height and try not to cut with the guide bar tip.

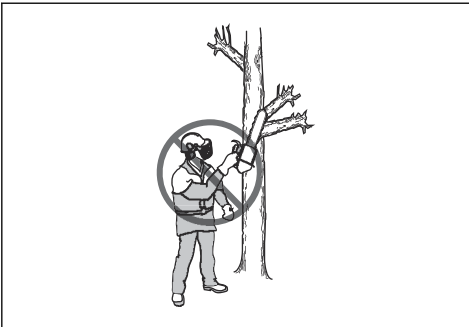

- Do not try pruning or limbing operations if you do not have special training.

- The vibration level increases if you cut with cutting equipment that is incorrect or not correctly sharpened. Cutting hardwoods, such as broadleaf trees, causes more vibration than cutting softwoods, such as conifers.

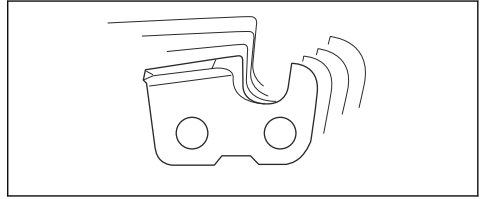

- Overexposure to vibration can lead to circulatory damage or nerve damage in persons who have decreased circulation. Speak to your physician if you experience symptoms of overexposure to vibration. Such symptoms include numbness, loss of feeling, tingling, pricking, pain, loss of strength, changes in skin colour or condition. These symptoms usually occur in the fingers, hands or wrists increases in cold temperatures.
- Prevent situations which you think is beyond your capability.
- It is not possible to include each possible situation you can face during operation. Always be careful and use your common sense.



- Use the battery in temperatures between -10°C (14°F) and 40°C (104°F).

Personal protective equipment



WARNING: Read the warning instructions that follow before you use the product.



- Most chainsaw accidents occur when the saw chain touches the operator. You must use approved

personal protective equipment during operation. Personal protective equipment does not give you full protection from injuries but it decreases the degree of injury if an accident occurs. Speak to your servicing dealer for recommendations about which equipment to use.

- Your clothing must be close-fitting but not limit your movements. Regularly do a check of the condition of the personal protective equipment.
- Use an approved protective helmet.
- Use approved hearing protection. Long-term exposure to noise can result in permanent damage to the hearing.
- Use approved protective glasses or a face visor to decrease the risk of injury from thrown objects. The product can throw objects, such as wood chips, small pieces of wood and more, at large force. This can result in serious injury, especially to the eyes.
- Use gloves with saw protection.
- Use pants with saw protection.
- Use boots with saw protection, steel toe-cap and non-slip sole.
- Always have a first-aid kit with you.
- Risk of sparks. Keep fire extinguishing tools and a shovel near to prevent forest fires.

Safety devices on the product



WARNING: Read the warning instructions that follow before you use the product.

- Do not use a product with safety devices that are damaged or do not operate correctly.
- Do a check of the safety devices regularly. Refer to *Maintenance and checks of the safety devices on the product on page 20*.
- If the safety devices are damaged or do not operate correctly, speak to your Husqvarna servicing dealer.

Functions of the user interface (T540i XP)

The user interface includes the start/stop button, SavE button, battery indicator, oil level indicator and the warning indicator. The warning indicator flashes if the chain brake is engaged or if there is a risk of overload. The overload protection temporarily stops the product and you cannot use the product until the temperature decreases. If the warning indicator shows a solid light, speak to your servicing dealer.

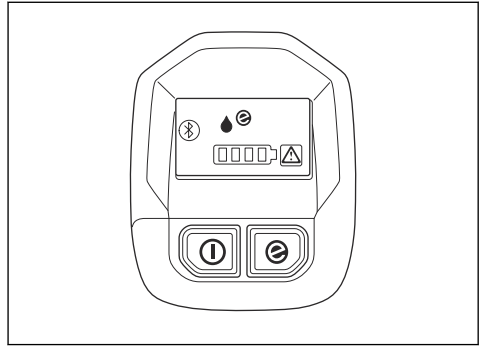

For more information about the user interface, refer to *Product overview on page 2*.

Functions of the user interface (T540i XPG)

The user interface includes the start/stop button, SavE button, battery indicator, oil level indicator, indicator for heat in the handgrips and the warning indicator. The warning indicator flashes if the chain brake is engaged or if there is a risk of overload. The overload protection temporarily stops the product and you cannot use the product until the temperature decreases. If the warning indicator shows a solid light, speak to your servicing dealer.

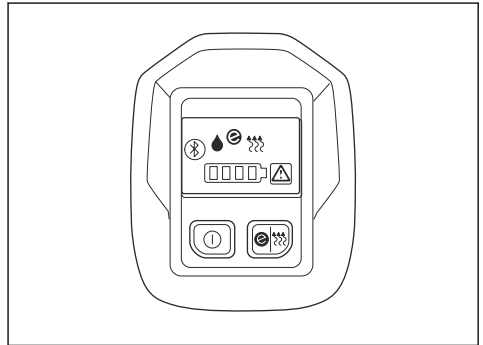

For more information about the user interface, refer to *Product overview on page 2*.

The automatic stop function

The product has an automatic stop function that stops the product if you do not use it for 3 minutes.

Note: If the chain brake is engaged, the product stays on for 30 minutes.

Chain brake and front hand guard

Your product has a chain brake that stops the saw chain if you get a kickback. The chain brake decreases the risk of accidents but only you can prevent them.



WARNING: Do not engage in situations where there is a risk of kickback. Be careful when you use your product and make sure that the kickback zone of the guide bar does not touch an object.

The chain brake engages manually by your left hand or automatically by the inertia release mechanism. Push the front hand guard forward to engage the chain brake manually. This movement starts a spring-loaded mechanism that stops the drive sprocket.

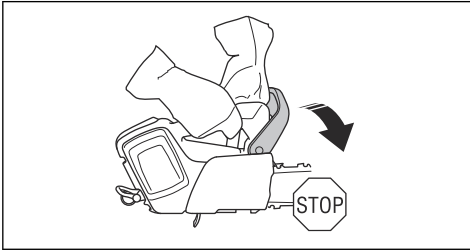

Pull the front hand guard rearward to disengage the chain brake.

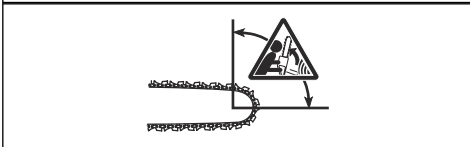
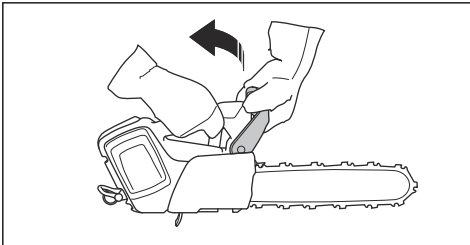

How the chain brake is engaged is in relation to the force of the kickback and the position of the product. If you get an intense kickback while the kickback zone is farthest away from you, the chain brake engages by the inertia release. If the kickback is small or the kickback zone is nearer you, the chain brake engages manually by your left hand.

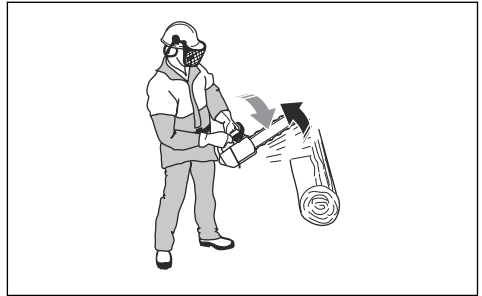

Use the chain brake as a parking brake when you start the product and when you move short distances. This decreases the risk that you or a person near you touches the saw chain.

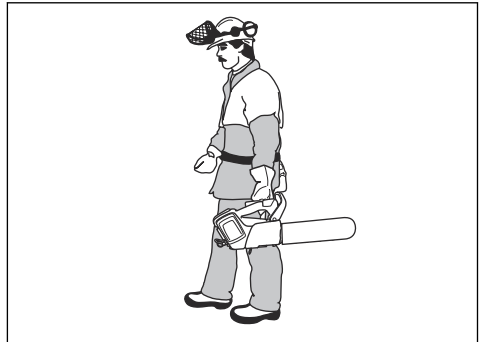

A kickback can be very sudden and intense. Most kickbacks are small and do not always engage the chain brake. If a kickback occurs when you use the product, hold tightly around the handles and do not let go.

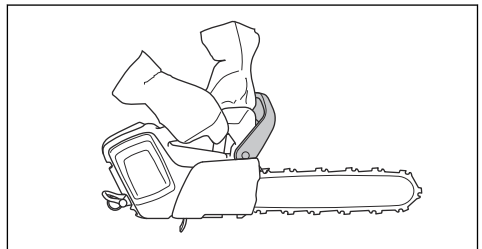

The front hand guard also decreases the risk to touch the saw chain if your hand lets go of the front handle.

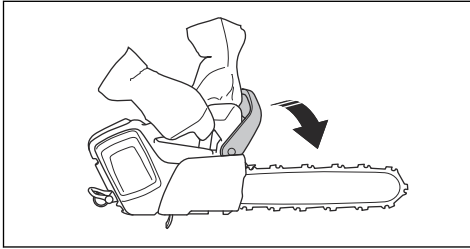

In the felling position you cannot engage the chain brake manually. The chain brake can in this position only be engaged by the inertia release mechanism.

Power trigger lockout

The power trigger lockout prevents accidental operation of the power trigger. If you push the power trigger lockout forward (A) and then push the power trigger lockout against the handle (B), it releases the power trigger (C). If you release the handle, the power trigger and the power trigger lockout move back to their initial positions.

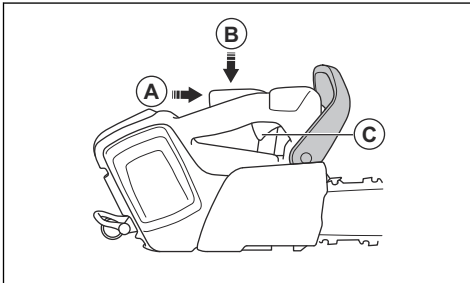

Chain catcher

The chain catcher catches the saw chain if it breaks or comes loose. If you have the correct chain tension, the risk decreases. You also decrease the risk if you do the correct maintenance on the guide bar and saw chain. See *Assembly on page 12* and *Maintenance on page 19* for instructions.

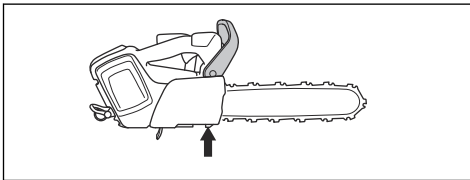

Safety instructions for maintenance



WARNING: Read the warning instructions that follow before you do maintenance on the product.

- Remove the battery before you do maintenance, other checks or assemble the product.
- The operator must only do the maintenance and servicing shown in this operator's manual. Turn to your servicing dealer for maintenance and servicing of a larger extension.
- Do not clean the battery or the battery charger with water. Strong detergent can cause damage to the plastic.
- If you do not do maintenance, it decreases the life cycle of the product and increases the risk of accidents.
- Special training is necessary for all servicing and repair work, especially for the safety devices on the product. If not all checks in this operator's manual are approved after you have done maintenance, turn to your servicing dealer. We guarantee that there are professional repairs and servicing available for your product.
- Only use original spare parts.

Safety instructions for the cutting equipment



WARNING: Read the warning instructions that follow before you use the product.

- Only use approved guide bar/saw chain combinations and filing equipment. Refer to *Accessories on page 29* for instructions.
- Use protective gloves when you use or do maintenance on the saw chain. A saw chain that does not move can also cause injuries.
- Keep the cutting teeth correctly sharpened. Obey the instructions and use the recommended file gauge. A saw chain that is damaged or incorrectly sharpened increases the risk of accidents.

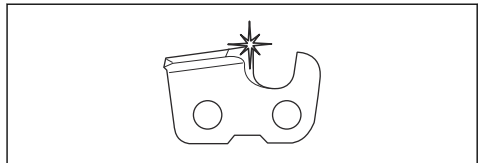

- Keep the correct depth gauge setting. Obey the instructions and use the recommended depth gauge

setting. Too large depth gauge setting increases the risk of kickback.

- Do maintenance on the cutting equipment regularly and keep it correctly lubricated. If the saw chain is not correctly lubricated, the risk of wear on the guide bar, saw chain and chain drive sprocket increases.

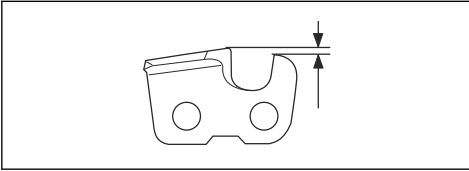

- Make sure that the saw chain has the correct tension. If the saw chain is not tight against the guide bar, the saw chain can derail. An incorrect saw chain tension increases wear on the guide bar, saw chain and chain drive sprocket. Refer to *Accessories on page 29*.

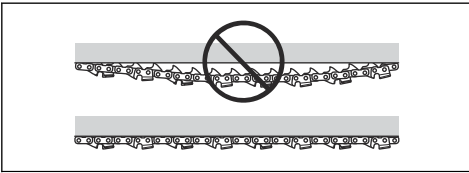
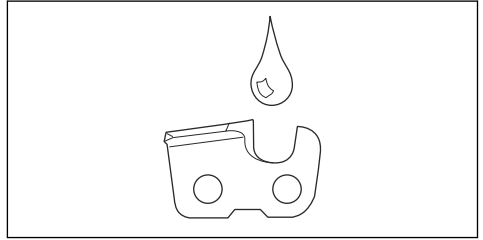

Assembly

To assemble the guide bar and saw chain



WARNING: Always remove the battery before you assemble or do maintenance on the product.

1. Disengage the chain brake.

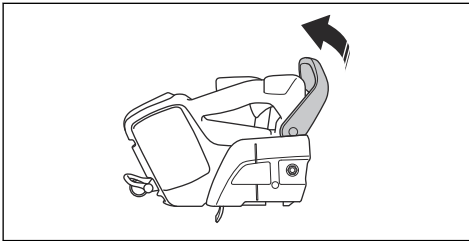

2. Loosen the bar nut. Remove the drive sprocket cover and the transportation ring (A).

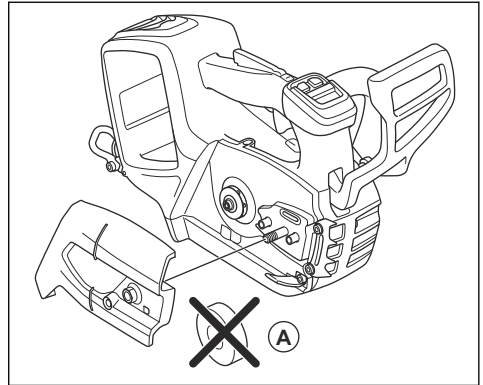

3. Install the guide bar on the bar bolt.

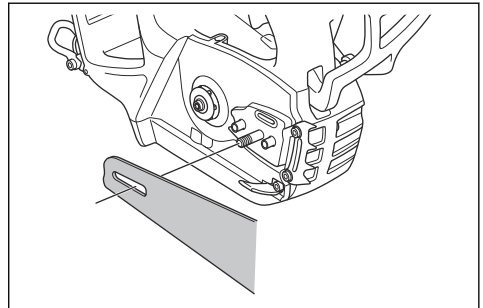

- Steer the guide bar to its most rear position. Lift the saw chain above the drive sprocket and engage it in the groove on the guide bar. Start on the top edge of the guide bar.

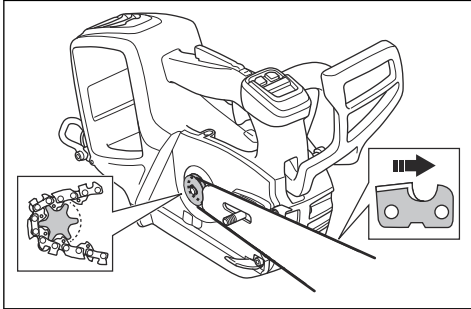

- Make sure that the edges of the cutters point forward on the top edge of the guide bar.
- Install the drive sprocket cover and steer the chain adjuster pin to the hole in the guide bar.
- Make sure that the drive links of the saw chain fit correctly on the drive sprocket.
- Make sure that the saw chain is correctly engaged in the groove in the guide bar.
- Tighten the bar nut with your fingers.
- Tighten the saw chain. Refer to *To adjust the tension of the saw chain on page 24* for instructions.

To install the air intake cover (optional)

If you cut materials that cause much dust and small particles in the air, an air intake cover is recommended for use.

- Hold the air intake cover against the fan housing. Make sure that you put the hole in the air intake cover on the right side of the hole in the fan housing.
- Carefully push the air intake cover against the fan housing until you hear a click.

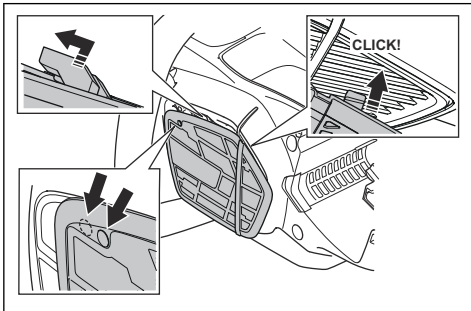

- Push the air intake cover to the left until the holes align.

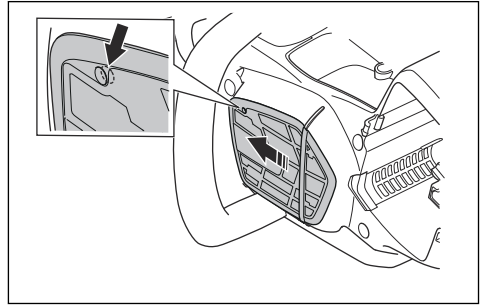

- Install the screw.

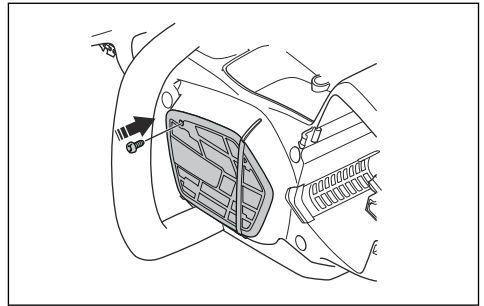

Operation

Introduction



WARNING: Read and understand the safety chapter before you use the product.

Husqvarna Connect

Husqvarna Connect is a free app for your mobile device. The Husqvarna Connect app gives extended functions for your Husqvarna product.

- Extended product information.
- Information about, and help with, product parts and servicing.

Bluetooth® wireless technology

Products with built-in Bluetooth® wireless technology can connect to mobile devices. The symbol for Bluetooth® wireless technology comes on when your mobile device is connected to the product.



To start to use Husqvarna Connect

1. Download the Husqvarna Connect app on your mobile device.
2. Register in the Husqvarna Connect app.
3. Follow the instruction steps in the Husqvarna Connect app to connect and register the product.

Note: Husqvarna Connect app is not available for download in all markets. Speak to your servicing dealer for more information.

To do a function check before you use the product

1. Do a check of the chain brake to make sure that it operates correctly and that it is not damaged.
2. Do a check of the power trigger lockout to make sure that it operates correctly and that it is not damaged.
3. Do a check of the keypad to make sure that it operates correctly.
4. Make sure that there is no oil on the handles.
5. Do a check to make sure that all parts are correctly attached and not damaged or missing.
6. Do a check of the chain catcher to make sure that it is attached correctly.
7. Do a check of the chain tension.

8. Charge the battery and make sure that it is correctly attached to the product.
9. Make sure that the saw chain stops when you release the power trigger.

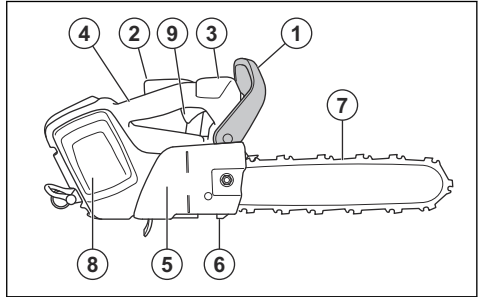

To use the correct chain oil



WARNING: Do not use waste oil, which can cause injury to you and the environment. Waste oil also causes damage to the oil pump, the guide bar and the saw chain.



WARNING: The saw chain can break if the lubrication of the cutting equipment is not sufficient. Risk of serious injury or death to the operator.



WARNING: Use the correct chain oil for this function to operate correctly. Speak to your servicing dealer when you select your chain oil.

- Use Husqvarna chain oil for maximum saw chain life and to prevent negative effects on the environment. If Husqvarna chain oil is not available, we recommend you to use a standard chain oil.
- Use a chain oil with good adherence to the saw chain.
- Use a chain oil with correct viscosity range that agrees with the air temperature.



CAUTION: In temperatures below 0°C/32°F some chain oils become too thick, which can cause damage to the oil pump components.

- Use the recommended cutting equipment. Refer to *Accessories on page 29*.
- Remove the cap to the chain oil tank.
- Fill the chain oil tank with chain oil.
- Attach the cap carefully.

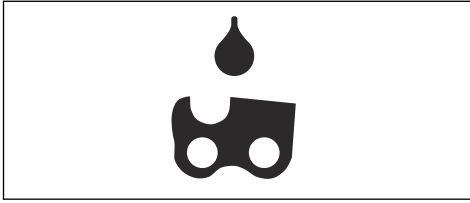

Note: To see where the chain oil tank is on your product, refer to *Product overview on page 2*.

Kickback information



WARNING: A kickback can cause serious injury or death to the operator or others. To decrease the risk you must know the causes of kickback and how to prevent them.

A kickback occurs when the kickback zone of the guide bar touches an object. A kickback can occur suddenly and with large force, which throws the product in the direction of the operator.

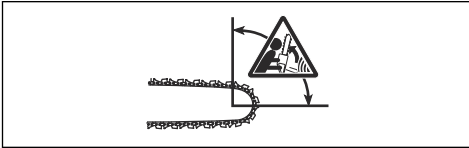

Kickback always occurs in the cutting plane of the guide bar. Usually, the product is thrown against the operator but can also move in a different direction. It is how you use the product when the kickback occurs that causes the direction of the movement.



A smaller bar tip radius decreases the force of the kickback.

Use a low kickback saw chain to decrease the effects of kickback. Do not let the kickback zone touch an object.



WARNING: No saw chain fully prevents kickback. Always obey the instructions.

Common questions about kickback

- **Will the hand always engage the chain brake during a kickback?**

No. It is necessary to use some force to push the front hand guard forward. If you do not use the force necessary, the chain brake will not be engaged. You must also hold the handles of the product stable with two hands during work. If a kickback occurs, it is possible that the chain brake does not stop the saw chain before it touches you. There are also some positions in which your hand can not touch the front hand guard to engage the chain brake.

- **Will the inertia release mechanism always engage the chain brake during kickback?**

No. First, the chain brake must operate correctly. Refer to *Maintenance and checks of the safety devices on the product on page 20* for instructions about how to do a check of the chain brake. We recommend you to do this each time before you use the product. Second, the force of the kickback must be large to engage the chain brake. If the chain brake is too sensitive, it can engage during rough operation.

- **Will the chain brake always protect me from injury during a kickback?**

No. The chain brake must operate correctly to give protection. The chain brake must also be engaged during a kickback to stop the saw chain. If you are near the guide bar, it is possible that the chain brake does not have time to stop the saw chain before it hits you.



WARNING: Only you and the correct working technique can prevent kickbacks.

To start the product

1. Do a check of the power trigger and power trigger lockout. Refer to *To do a check of the power trigger lockout on page 21*.
2. Push the front hand guard forward to engage the chain brake.

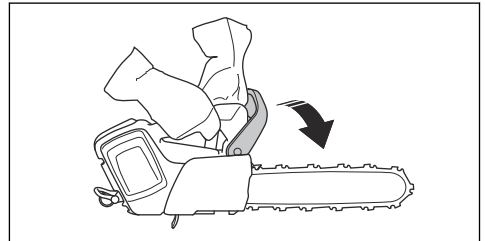

3. Put the battery in the battery holder.

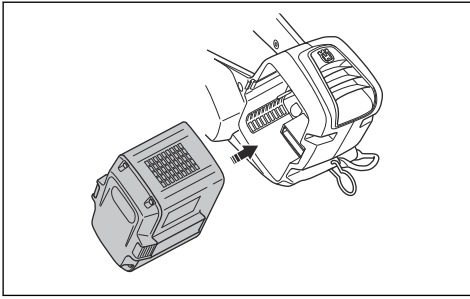

CAUTION: Make sure that the battery is installed correctly into the battery holder. If the battery does not move easily into the battery holder, the position is not correct.

4. Push on the lower part of the battery until you hear a click.

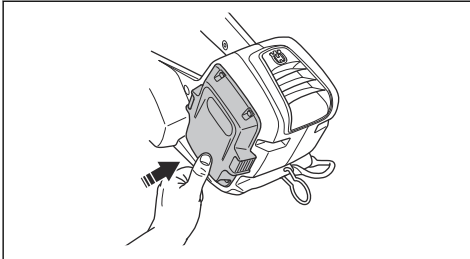

5. Push and hold the start/stop button until a green LED light comes on.



WARNING: If you start the product in a tree, engage the chain brake before you let the product hang from a stop.

To use the SavE function

The SavE function decreases the chain speed and the power of the product.

1. Push the SavE button quickly. The green LED comes on.

2. Push the SavE button again to disconnect the function. The green LED goes off.



To engage and disengage the heat in the handles (T540i XPG)

The product has heated handles.

- Push and hold the SavE button for 1 second to engage the heat in the handles. The indicator for heat in the handles comes on.

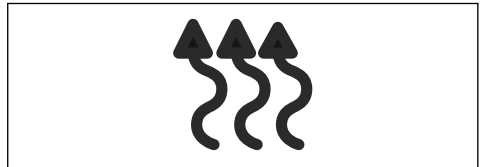

- Push the SavE button quickly to disengage the heat in the handles. The indicator for heat in the handles goes off.

Oil level indicator

The oil level indicator shows when it is time to fill chain oil.

1. When the oil level indicator comes on, fill with chain oil. Refer to *To use the correct chain oil on page 14*.
2. Start the product and wait 1-2 minutes. The oil level indicator goes off.

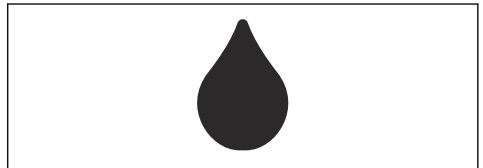

To stop the product

1. Push and hold the start/stop button until the green LED light comes off.



2. Push the battery release buttons and remove the battery from the battery holder to prevent accidental start.

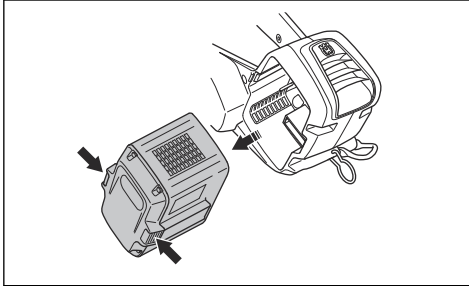

General information about working technique

Below we give you some general information about how to use this product.



WARNING: The information related to working technique in this operator's manual is not considered correct training to operate this tree-service product. This product must be used by tree-service operators with special training only! Use without the correct training can result in serious injuries. Do not try any task that you do not feel sure of!

- To cut on the pull stroke is when you cut with the bottom of the guide bar. The saw chain pulls through the tree when you cut. In this position you have better control of the product and the position of the kickback zone.

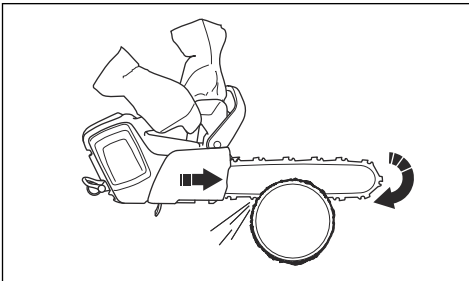

- To cut on the push stroke is when you cut with the top of the guide bar. The saw chain pushes the product in the direction of the operator.

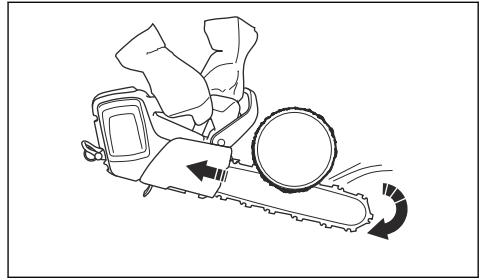

WARNING: Be careful when you cut on the push stroke. If the saw chain gets trapped in the trunk, the product can be pushed at you. You must prevent this force or there is a risk that the kickback zone of the guide bar touches the tree. This will lead to a kickback.

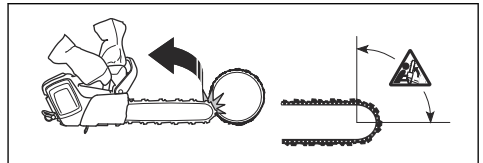

- Use full power when you cut.
- Let go of the power trigger after each cut.



CAUTION: Motor damage can occur if you run the motor for too long at full power and without load. One example is if you cut without resistance from the saw chain.

To prepare the product for operation in the tree

Ground operator

As a ground operator, do the steps that follow.

1. Examine the product.
2. Charge the battery.
3. Attach the end of an approved safety stop to the rope eyelet.

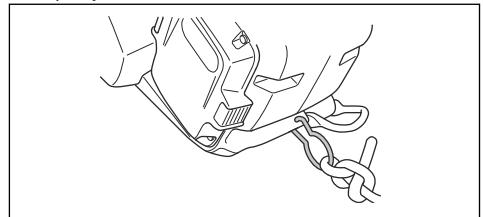

Note: A safety stop makes sure that the product does not hit the ground if it falls.

4. Make sure that there is a carabiner on the other end of the safety stop.
5. Start the product.
6. Stop the product.
7. Engage the chain brake.
8. Lift the product to the operator in the tree. Use ascent tools.



WARNING: Make sure that the product is safely attached when you lift it to the operator in the tree.

Tree operator

As a tree operator, follow the instructions below.

1. Before you disconnect the safety stop from the ascent tools, you must attach the product to the harness. Attach the product to the harness through the belt eyelet or a steel ring on the safety stop.

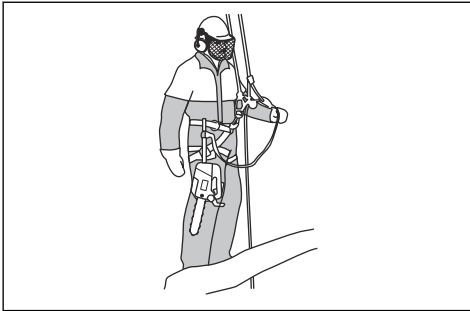

WARNING: Attach the safety stop to 1 of the recommended connection points on the harness.



WARNING: If you use only the safety stop to attach the product to the harness, lower the product fully down with the safety stop. Do not let go of the product from a height.

2. Use approved carabiners to attach the free end of the safety stop to one of the connection points on the harness. This is your primary connection point.



CAUTION: The safety stop must only be attached to the rope eyelet.

3. Make sure that you are in a stable and safe position to make the cut.
4. Release the product from the secondary connection point, start the product and make the cut.

5. Engage the chain brake directly after the cut is completed.

To operate the product in a tree



WARNING: Most accidents occur when the operator does not have full control of the product or the work position.

- Keep a safe work position.
- Cut horizontal sections at hip level and vertical sections at solar plexus level.
- Hold the product with 2 hands.
- Make sure that you are stable on your feet and keep a low lateral force when you cut vertical branches. Steer the safety line through a different connection point to remove or prevent increasing lateral forces. You can also use an adjustable stop directly from the harness to a different connection point.

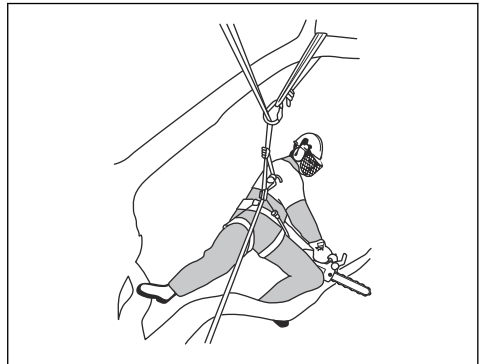

- Use a foot loop to keep a safe work position.



- Do a check of the harness, belt and ropes at a regular interval.

- If you must climb with the product, attach the product to the rear connection point on the harness. The rear connection point keeps the product clear from climbing lines and makes sure that the weight has central support down your spine.

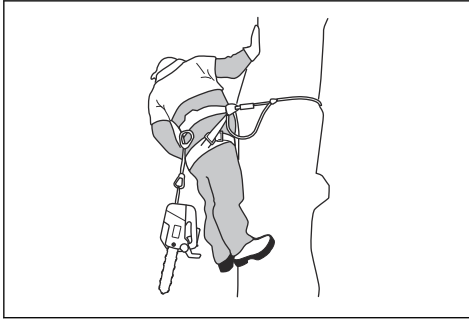

WARNING: You must engage the chain brake before you let the product hang from a strop.

To remove a trapped product

1. Stop the product.
2. Attach the product safely to the tree inboard, against the trunk side, of the cut or a different tool line.
3. Carefully pull the saw away from the kerf while you lift the branch as necessary.



WARNING: Do not try to pull the product free. Risk of serious injury.

4. If it is necessary, use a hand saw or a second chainsaw to release the product. Cut the branch at a minimum of 30 cm/12 in from the caught product. Make the cut on the outer end from where the product is caught.

Maintenance

Introduction



WARNING: Read and understand the safety chapter before you do maintenance on the product.

The following is a list of the maintenance steps that you must do on the product. See *Maintenance on page 19* for more information.

Maintenance schedule



WARNING: Remove the battery before you do maintenance.

Maintenance	Before use	Weekly	Monthly
Clean the external parts of the product.	X		
Make sure that the power trigger and the power trigger lockout function correctly.	X		
Clean the chain brake and make sure that it operates safely. Make sure that the chain catcher is not damaged. Replace it if necessary.	X		
Turn the guide bar for more equal wear. Make sure that the lubrication hole in the guide bar is not clogged. Clean the bar groove.	X		
Make sure that the guide bar and saw chain have sufficient oil.	X		
Do a check of the saw chain. Look for cracks and make sure that the saw chain is not rigid or unusually worn. Replace if necessary.	X		
Sharpen the saw chain. Do a check of its tension and condition. Do a check for wear on the drive sprocket and replace is necessary.	X		
Clean the air inlet on the product.	X		

Maintenance	Before use	Weekly	Monthly
Make sure that the screws and nuts are tight.	X		
Make sure that the keypad works correctly and that it is not damaged.	X		
Use a file to remove burrs from the edges of the guide bar.		X	
Do a check of the connections between the battery and the product. Do a check of the connection between the battery and the battery charger.			X
Empty and clean the oil tank.			X
Blow through the product and battery cooling slots gently with compressed air.			X

Maintenance and checks of the safety devices on the product

To do a check of the front hand guard

Regularly do a check of the front hand guard.

1. Make sure that the front hand guard does not have damages such as cracks.

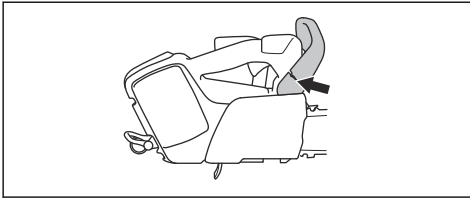

2. Make sure that the front hand guard moves freely and that it is attached safely to the product.

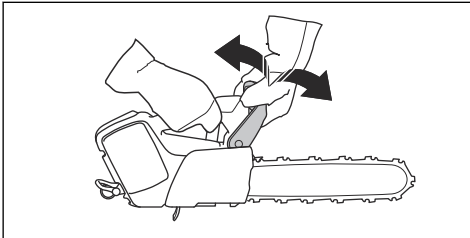

To do a check of the brake trigger

1. Start the product and make sure that the saw chain does not touch the ground or an object. See *To start the product on page 15* for instructions.

2. Hold the product tight. Put your hands around the handles.

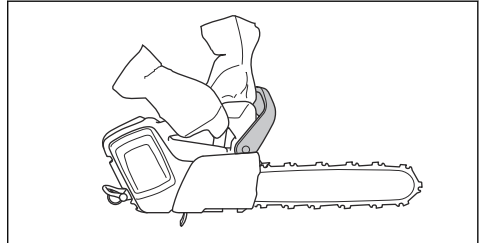

3. Apply full power and tilt your left wrist forward to engage the chain brake.
4. Make sure that the saw chain stops directly.

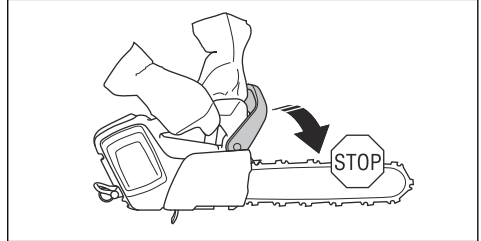

WARNING: Do not let go of the front handle!

To do a check of the power trigger lockout

1. Make sure that the power trigger and power trigger lockout move freely and that the return spring operates correctly.

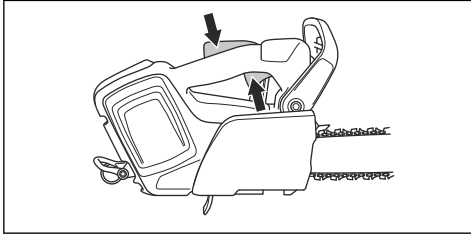

2. Push the power trigger lockout forward (A) and down (B). Hold the power trigger against the handle and make sure that it goes back to its initial position when you release it.

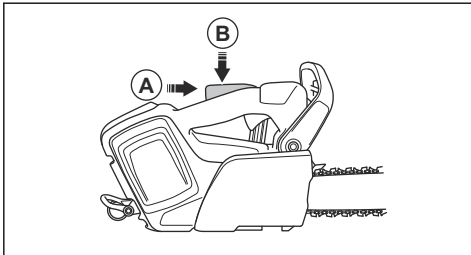

3. Make sure that the power trigger is locked at the idle position when the power trigger lockout is released.

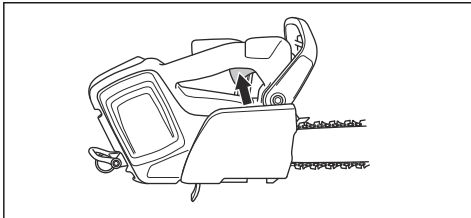

4. Start the product and apply full power.
5. Release the power trigger and make sure that the saw chain stops and stays stationary.



WARNING: If the saw chain rotates when the power trigger is in the idle position, speak to your servicing dealer.

To do a check of the chain catcher

1. Make sure that there is no damage on the chain catcher.

2. Make sure that the chain catcher is stable and attached to the body of the product.

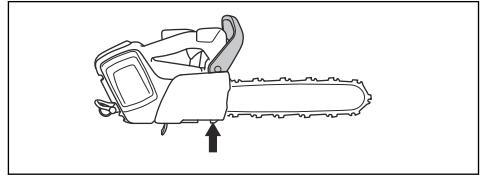

To do a check of the functions of the user interface

1. Start the product. Refer to *To start the product on page 15*.
2. Push and hold the start/stop button.
3. Make sure that the product stops and that the green LED goes off.

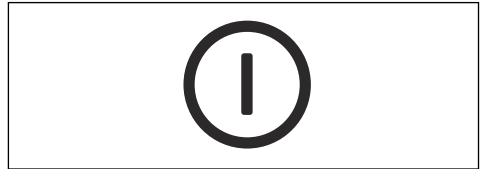

To do a check of the battery and the battery holder

1. Clean the battery and the battery holder with a soft brush.
2. Clean the cooling slots and battery connectors.

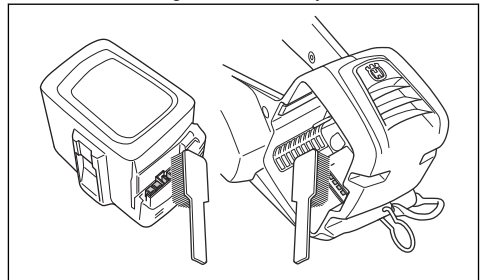

3. Make sure that the battery has no cracks or other damages.

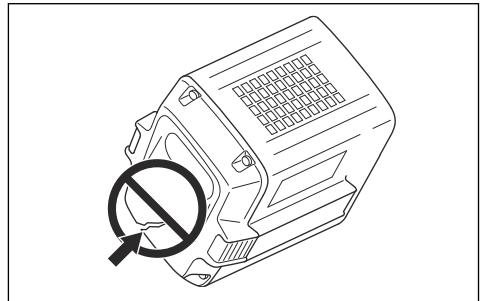

To do a check of the battery charger

1. Make sure that the battery charger and the power supply cord is not damaged. Look for cracks and other damages.

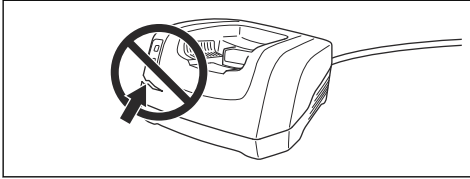

To clean the cooling system

The cooling system keeps the engine temperature down. The cooling system includes the air intake on the left side of the product and the fan on the motor.

1. Clean the cooling system with a brush weekly or more frequently if it is necessary.

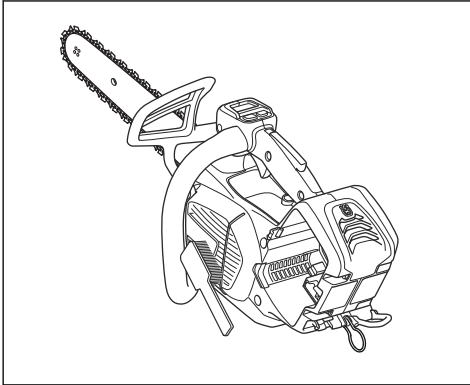

2. Make sure that the cooling system is not dirty or blocked.



CAUTION: A dirty or blocked cooling system can cause the product to become too hot. This causes damage to the product.

To sharpen the saw chain

Information about the guide bar and saw chain



WARNING: Use protective gloves when you use or do maintenance on the saw chain. A saw chain that does not move can also cause injuries.

Replace a worn or damaged guide bar or saw chain with the guide bar and saw chain combination recommended by Husqvarna. This is necessary to keep the safety functions of the product. Refer to *Accessories on*

page 29, for a list of replacement bar and chain combinations that we recommend.

- Guide bar length, in/cm. Information about the guide bar length can usually be found on the rear end of the guide bar.

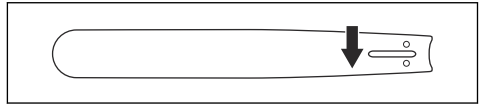

- Number of teeth on bar tip sprocket (T).

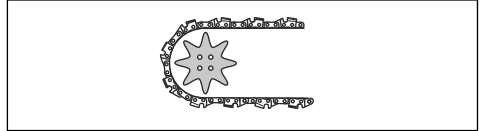

- Chain pitch, in. The distance between the drive links of the saw chain must align with the distance of the teeth on the bar tip sprocket and drive sprocket.

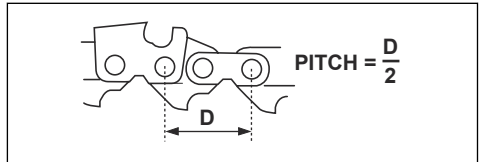

- Number of drive links. The number of drive links is decided by the type of guide bar.

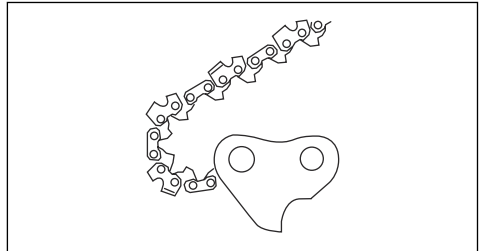

- Bar groove width, in/mm. The groove width in guide bar must be the same as the chain drive links width.

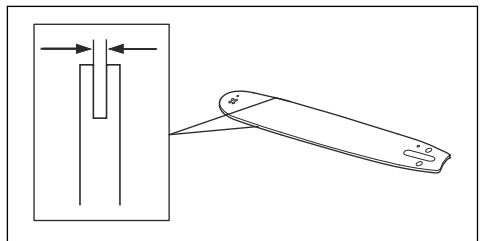

- Chain oil hole and hole for chain tensioner. The guide bar must align with product.

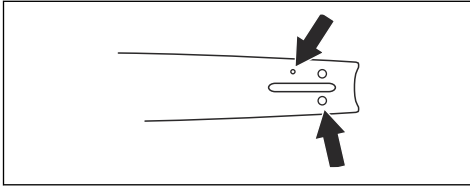

- Drive link width, mm/in.

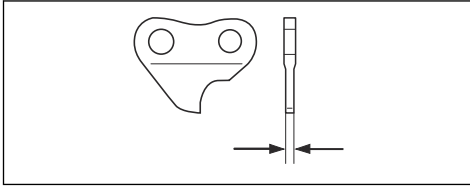

General information about how to sharpen the cutters

Do not use a blunt saw chain. If the saw chain is blunt, you must apply more pressure to push the guide bar through the wood. If the saw chain is very blunt, there will be no wood chips but sawdust.

A sharp saw chain eats through the wood and the wood chips becomes long and thick.

The cutting tooth (A) and the depth gauge (B) together makes the cutting part of the saw chain, the cutter. The difference in height between the two gives the cutting depth (depth gauge setting).

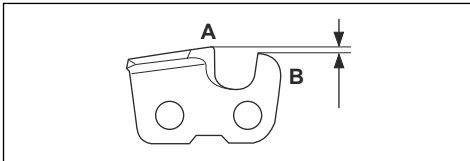

When you sharpen the cutter, think about the following:

- Filing angle.

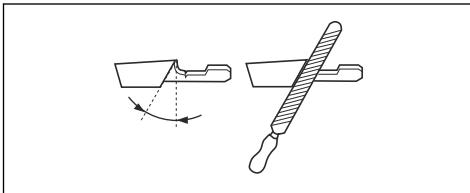

- Cutting angle.

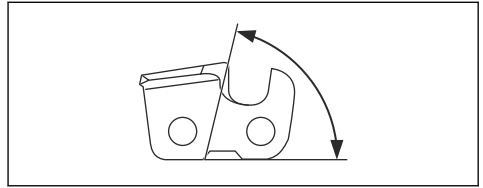

- File position.

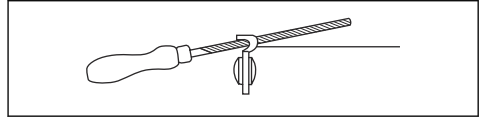

- Round file diameter.

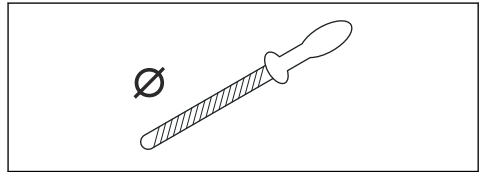

It is not easy to sharpen a saw chain correctly without the correct equipment. Use a Husqvarna recommended file gauge. This will help you to keep maximum cutting performance and the kickback risk at a minimum.



WARNING: The force of the kickback increases a lot if you do not follow the sharpening instructions.

Note: Refer to *Accessories on page 29* for information about sharpening of the saw chain.

To sharpen the cutters

1. Use a round file and a file gauge to sharpen the cutting teeth.

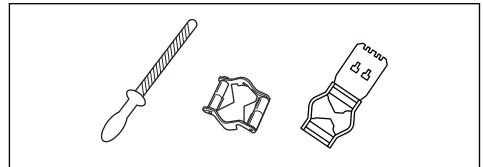

Note: Refer to *Accessories on page 29* for information about which file and gauge that Husqvarna recommends for your saw chain.

2. Apply the file gauge correctly on to the cutter. Refer to the instruction supplied with the file gauge.

3. Move the file from the inner side of the cutting teeth and out. Decrease the pressure on the pull stroke.

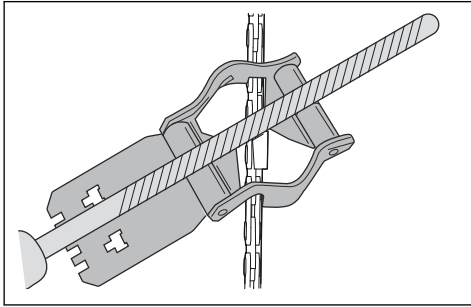

4. Remove material from one side of all the cutting teeth.
5. Turn the product around and remove material on the other side.
6. Make sure that all cutting teeth are the same length.

General information about how to adjust the depth gauge setting

The depth gauge setting (C) decreases when you sharpen the cutting tooth (A). To keep maximum cutting performance you must remove filing material from the depth gauge (B) to receive the recommended depth gauge setting. See *Accessories* on page 29 for instructions about how to receive the correct depth gauge setting for your saw chain.

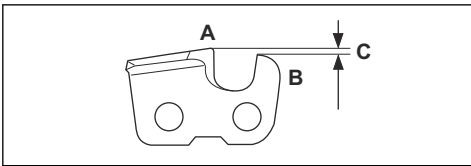

WARNING: The risk of kickback increases if the depth gauge setting is too large!

To adjust the depth gauge setting

Before you adjust the depth gauge setting or sharpen the cutters, refer to *To sharpen the cutters* on page 23, for instructions. We recommend you to adjust the depth gauge setting after each third operation that you sharpen the cutting teeth.

We recommend that you use our depth gauge tool to receive the correct depth gauge setting and bevel for the depth gauge.

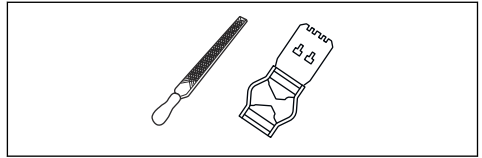

1. Use a flat file and a depth gauge tool to adjust the depth gauge setting. Only use a Husqvarna recommended depth gauge tool to get the correct depth gauge setting and bevel for the depth gauge.
2. Put the depth gauge tool on the saw chain.

Note: See the package of the depth gauge tool for more information about how to use the tool.

3. Use the flat file to remove the part of the depth gauge that extends through the depth gauge tool.

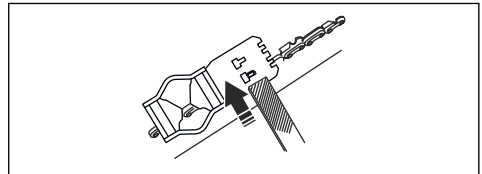

To adjust the tension of the saw chain



WARNING: A saw chain with an incorrect tension can come loose from the guide bar and cause serious injury or death.

A saw chain becomes longer when you use it. Adjust the saw chain regularly.

1. Loosen the bar nut that holds the drive sprocket cover and chain brake. Use the combination wrench.

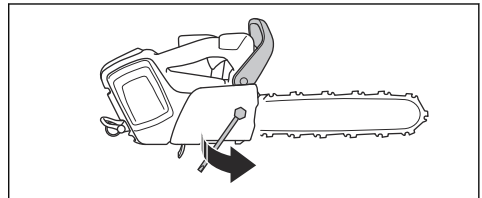

2. Lift the front of the guide bar and turn the chain tensioning screw. Use the combination wrench.
3. Tighten the saw chain until it is tight against the guide bar.

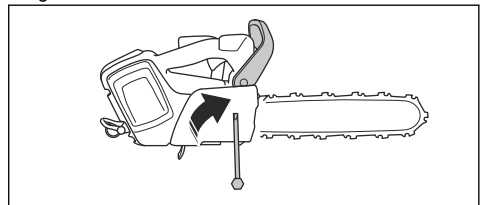

4. Tighten the bar nut with the combination wrench and lift the front of the guide bar at the same time.

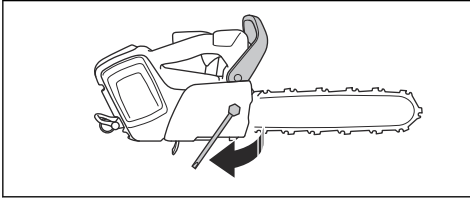

5. Make sure that you can pull the saw chain around freely by hand and that it does not hang from the guide bar.

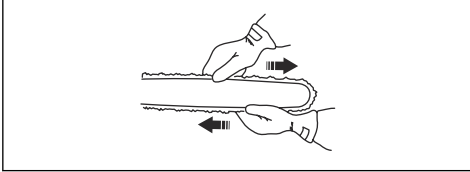

Note: Refer to *Product overview on page 2* for the position of the chain tensioning screw on your product.

To do a check of the saw chain lubrication

Do a check of the saw chain lubrication each third battery charge.

1. Start the product and let it run at full speed. Hold the bar approximately 20 cm (8 inches) above a light coloured surface.
2. If the saw chain lubrication is correct, you will see a clear line of oil on the surface less than 1 minute.



3. If the saw chain lubrication is not correct, do the following checks.

- a) Do a check of the oil channel in the guide bar to make sure that it is not blocked. Clean if necessary.

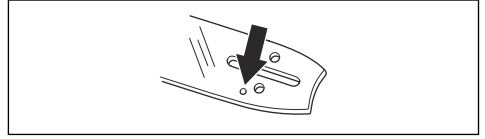

- b) Do a check of the groove in the edge of the guide bar to make sure that it is clean. Clean if necessary.

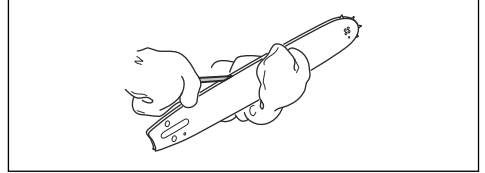

- c) Make sure that the bar tip sprocket turns freely and that the lubricating hole in the guide bar tip sprocket is not blocked. Clean and lubricate if necessary.



4. If the saw chain lubrication does not work after following the steps above, speak to your servicing dealer.

To do a check of the chain drive sprocket

- Examine the chain drive sprocket for wear. Replace the chain drive sprocket if it is necessary.
- Replace the chain drive sprocket each time that you replace the saw chain. The concave side of the large washers (A) must point in the direction of the drive sprocket (B).

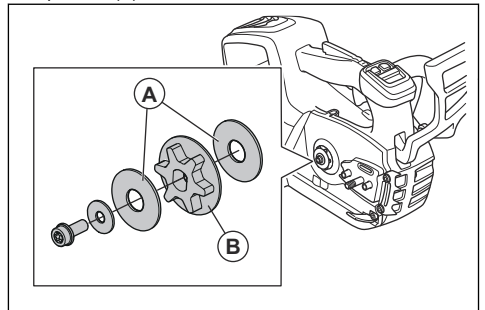

To examine the cutting equipment

1. Make sure that there are no cracks in rivets and links and that no rivets are loose. Replace if it is necessary.

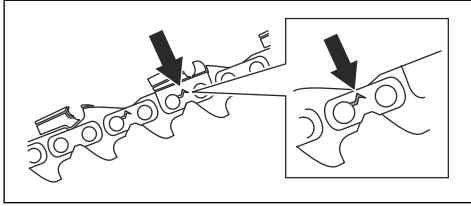

2. Make sure that the saw chain is easy to bend. Replace the saw chain if it is rigid.
3. Compare the saw chain with a new saw chain to examine if the rivets and links are worn.
4. Replace the saw chain when the longest part of the cutting tooth is less than 4 mm/0.16 in. Also replace the saw chain if there are cracks on the cutters.

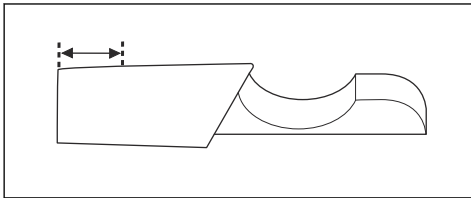

To do a check of the guide bar

1. Make sure that the oil channel is not blocked. Clean if it is necessary.

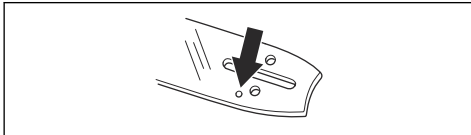

2. Examine if there are burrs on the edges of the guide bar. Remove the burrs using a file.

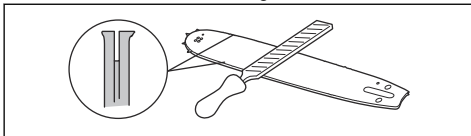

3. Clean the groove in the guide bar.

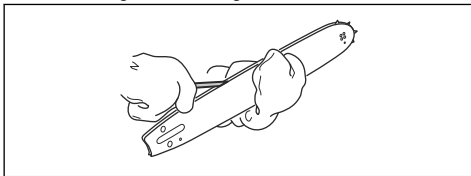

4. Examine the groove in the guide bar for wear. Replace the guide bar if it is necessary.

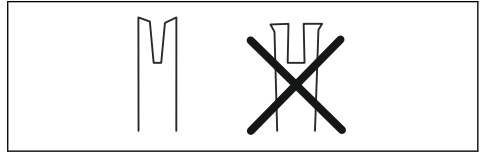

5. Examine if the guide bar tip is rough or very worn.

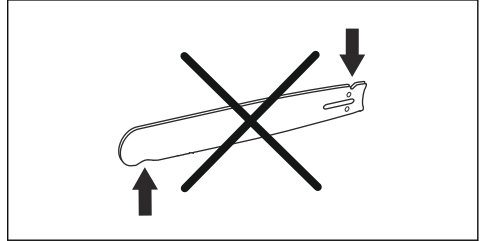

6. Make sure that the bar tip sprocket turns freely and that the lubricating hole in the bar tip sprocket is not blocked. Clean and lubricate if it is necessary.

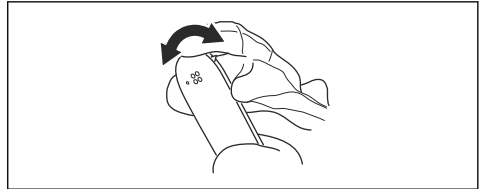

7. Turn the guide bar daily to extend its life cycle.

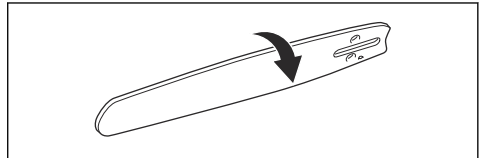

To adjust the chain oil flow



WARNING: Stop the motor before you make adjustments to the oil pump.

- Turn the adjustment screw for the oil pump. Use a screwdriver or the combination wrench.

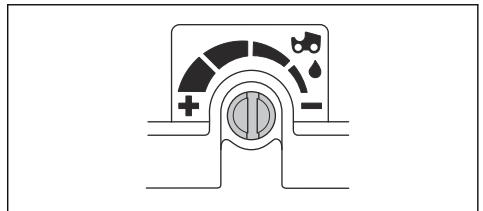

- a) Turn the adjustment screw counterclockwise to increase the oil flow.

- b) Turn the adjustment screw clockwise to decrease the oil flow.

Troubleshooting

User interface

LED screen	Possible faults	Possible solution
The warning indicator flashes.	Chain brake is engaged.	Disengage the chain brake.
	Temperature deviation.	Let the product to cool down.
	Overload. The saw chain can not move.	Release the saw chain.
	The power trigger and the start/stop button are pushed at the same time.	Release the power trigger to activate the product.
Green activate LED flashing.	Low battery voltage.	Charge the battery.
The warning indicator is on.	Service.	Speak to your servicing dealer.

Transportation, storage and disposal

Transportation and storage

- The supplied Li-ion batteries obey the Dangerous Goods Legislation requirements.
- Obey the special requirement on package and labels for commercial transportation, including by third parties and forwarding agents.
- Speak to a person with special training in dangerous material before you send the product. Obey all applicable national regulations.
- Use tape on open contacts when you put the battery in a package. Put the battery in the package tightly to prevent movement.
- Remove the battery for storage or transportation.
- Put the battery and the battery charger in a space that is dry and free from moisture and frost.
- Do not keep the battery in an area where static electricity can occur. Do not keep the battery in a metal box.
- Put the battery in storage where the temperature is between 5°C/41°F and 25°C/77°F and away from open sunlight.
- Put the battery charger in storage where the temperature is between 5°C/41°F and 45°C/113°F and away from open sunlight.
- Use the battery charger only when the surrounding temperature is between 5°C/41°F and 40°C/104°F.
- Charge the battery 30% to 50% before you put it in storage for long periods.
- Put the battery charger in storage in a space that is closed and dry.
- Keep the battery away from the battery charger during storage. Do not let children and other not approved persons to touch the equipment. Keep the equipment in a space that you can lock.
- Clean the product and do a full servicing before you put the product in storage for a long time.
- Use the transportation guard on the product to prevent injuries or damage on the product during transportation and storage.
- Attach the product safely during transportation.

Disposal of the battery, battery charger and product

The symbol below means that the product is not domestic waste. Recycle it at a recycling station for electrical and electronic equipment. This helps to prevent damage to the environment and to persons.

Speak to local authorities, domestic waste service or your dealer for more information.



Note: The symbol shows on the product or package of the product.

Technical data

Technical data

	T540i XP	T540i XPG
Motor		
Type	BLDC (brushless) 36V	BLDC (brushless) 36V
Features		
Low energy mode	savE	savE
Lubrication system		
Type of oil pump	Adjustable	Adjustable
Oil tank capacity, l/cm ³	0.18/180	0.18/180
Weight		
Chainsaw without battery, guide bar, saw chain and empty chain oil tank, kg	2.5	2.6
Water protection level		
IPX4	Yes	Yes
Noise emissions¹		
Sound power level, measured dB(A)	101	101
Sound power level, guaranteed L _{WA} dB(A)	103	103
Sound levels²		
Equivalent sound pressure level at the operator's ear, dB(A)	92	92
Vibration levels³		

¹ Noise emissions in the environment measured as sound power (L_{WA}) in conformity with EC directive 2000/14/EC.

² Equivalent sound pressure level, according to ISO 22868:2011, is calculated as the time-weighted energy total for different sound pressure levels under various working conditions. Typical statistical dispersion for equivalent sound pressure level is a standard deviation of 1 dB (A).

³ Vibration level, according to EN 62841-4-1. Reported data for vibration level has a typical statistical dispersion (standard deviation) of 1 m/s². Declared vibration data from measurements when the machine is fitted with a bar length and recommended chain type. If the machine is fitted with a different bar length, the vibration level may vary by max ± 1.5 m/s².

	T540i XP	T540i XPG
Front handle m/s ²	2.2	2.2
Rear handle m/s ²	4.3	4.3
Equivalent vibration levels ⁴		
Front handle m/s ²	2.1	2.1
Rear handle m/s ²	3.5	3.5
Saw chain/guide bar		
Recommended bar lengths, inch/cm	12-16/30-40	12-16/30-40
Usable cutting length, inch/cm	11-15/28-38	11-15/28-38
Type of drive sprocket/number of teeth	m0.325"/7 (SP21G), 1/4"/8 (H00)	m0.325"/7 (SP21G), 1/4"/8 (H00)
Maximum chain speed / (savE), m/s	24 (18)	24 (18)
Radio frequency data for Bluetooth®		
Frequency band, GHz	2.4-2.4835	2.4-2.4835
Output power, max dBm 0	0	0

Accessories

Guide bar and saw chain combinations

The following cutting attachments are approved for Husqvarna T540i XP.



WARNING: Use the BLi200X battery when you use the saw chain SP11G.

Guide bar				Saw chain		
Length, in	Chain pitch, in	Gauge, mm	Max. nose radius	Type	Length, drive links (no.)	Low kickback
12	0.325 mini	1.1	8T	Husqvarna SP21G	51	Yes
14					59	
16					64	
12	1/4"	1.3	Carving	Husqvarna H00	68	No
10"	1/4" mini	1.1	8T	SP11G	60	
12"					68	







⁴ Equivalent vibration level is measured and calculated as for combustion engine powered chainsaws. These figures are quoted to be able to compare vibration data regardless of type of engine according to ISO 22867:2011.

Filing equipment and filing angles

Using Husqvarna file gauge will give you the correct filing angles. We recommend you to always use a Husqvarna file gauge to restore the sharpness of the

saw chain. The part numbers are given in the table below.

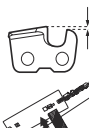
If you do not know which saw chain you have on your product, turn to your servicing dealer.

							
SP21G	5/32 in / 4.0 mm	60°	30°	0°	0.025 in/ 0.65 mm	595 00 46-01	595 00 47-01
H00	5/32 in / 4.0 mm	85°	30°	10°	0.025 in/ 0.65 mm	580 68 75-01	580 68 74-01
SP11G	9/64 in / 3.5 mm	60°	30°	0°	0.016 in/0.4 mm	529 93 71-01	529 93 71-01

Approved batteries for the product

Note: For maximum performance of the cutting equipment, Husqvarna, recommends to use 1 of the approved batteries that follow. It is possible to use

other batteries but then the performance of the cutting equipment decreases.

Battery	BLi200X	BLi300	40-B220X	40-B330X
Type	Lithium-ion	Lithium-ion	Lithium-ion	Lithium-ion
Battery capacity, Ah	5.2	9.4	6.0	9.0
Nominal voltage, V	36	36	36	36
Weight, kg	1.4	2.0	1.4	2.0

Approved battery chargers

Battery charger	QC500
Input voltage, V	100-240
Frequency, Hz	50-60
Power, W	500

Declaration of Conformity

EU Declaration of Conformity

We, **Husqvarna AB**, SE-561 82 Huskvarna, Sweden, tel: +46-36-146500, declare on our sole responsibility that the product:

Description	Cordless battery chainsaw
Brand	Husqvarna
Type / Model	T540i XP, T540i XPG
Identification	Serial numbers dating from 2023 and onwards

complies fully with the following EU directives and regulations:

Regulation	Description
2006/42/EC	"relating to machinery"
2014/53/EU	"relating to radio equipment"
2014/30/EU	"relating to electromagnetic compability"
2011/65/EU	"on the restriction of the use of certain hazardous substances in electrical and electronic equipment"
2000/14/EC	"relating to the noise emissions in the environment"

and that the following standards and/or technical specifications are applied: IEC 62841-1:2014, EN ISO 11681-2:2011/A1:2017, EN 61000-6-1:2007, EN 61000-6-3:2007+A1:2011, EN IEC 63000:2018.

For products with Bluetooth® functionality also: ETSI EN 301 489-1 v.2.1.1, ETSI EN 301 489-17 v.3.1, EN 300 328 v.2.2.2.

Certificate numbers: 0404/20/2544, 01/162/004.

Notified body: 0404, SMP, Svensk Maskinprovning AB, Box 4053, SE-904 03, Umeå, Sweden has carried out EC type examination in accordance with the machinery directive's (2006/42/EC) article 12, clause 3b.

SMP, Svensk Maskinprovning AB has also verified agreement with annex V of the council's directive 2000/14/EC.

For information relating to noise emissions, refer to *Technical data on page 28*.

Huskvarna, 2023-09-15

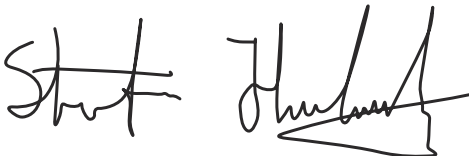

Stefan Holmberg, R&D Director, Technology Management, Husqvarna AB.

Responsible for technical documentation.



UK Declaration of Conformity

We, **Husqvarna AB**, SE-561 82 Huskvarna, Sweden, tel: +46-36-146500, declare on our sole responsibility that the product:

Description	Cordless battery chainsaw
Brand	Husqvarna
Type / Model	T540i XP, T540i XPG
Identification	Serial numbers dating from 2023 and onwards

complies fully with the following UK regulations:

Description
The Supply of Machinery (Safety) Regulations 2008
The Radio Equipment Regulations 2017
Electromagnetic Compatibility Regulations 2016
The Noise Emission in the Environment by Equipment for use Outdoors Regulations 2001
The Restriction of the Use of Certain Hazardous Substances in Electrical and Electronic Equipment Regulations 2012

and that the following standards and/or technical specifications are applied: IEC 62841-1:2014, EN ISO 11681-2:2011/A1:2017, EN 61000-6-1:2007, EN 61000-6-3:2007+A1:2011, EN IEC 63000:2018.

For products with Bluetooth® functionality also: ETSI EN 301 489-1 v.2.1.1, ETSI EN 301 489-17 v.3.1, EN 300 328 v.2.2.2.

Certificate numbers: 0404/20/2544, 01/162/004.

Notified body: 0404, SMP Svensk Maskinprovning AB, Box 4053, SE-904 03, Umeå, has carried out EC type examination in accordance with the machinery directive's (2006/42/EC) article 12, clause 3b.

SMP, Svensk Maskinprovning AB has also verified agreement with annex V of the council's directive 2000/14/EC.

For information relating to noise emissions, refer to *Technical data on page 28*.

Huskvarna, 2023-09-15

Stefan Holmberg, R&D Director, Technology Management, Husqvarna AB.

Responsible for technical documentation.



UK Importer:
Husqvarna UK Ltd
Preston Road, Co. Durham
DL5 6UP

Two handwritten signatures in black ink are present. The first signature is on the left and the second is on the right, both appearing to be in cursive script.

Registered trademarks

The *Bluetooth*[®] word mark and logos are registered trademarks owned by *Bluetooth SIG, inc.* and any use of such marks by Husqvarna is under license.

Husqvarna®

www.husqvarna.com

Original instructions



1144078-26



2024-06-05