

# **Operator's manual** **281XP 288XP**

Please read the operator's manual carefully and make sure you understand the instructions before using the machine.

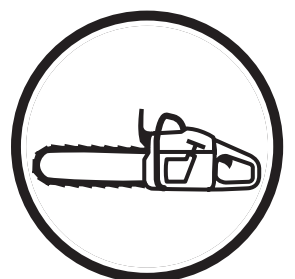

**English**

# KEY TO SYMBOLS

## Symbols on the machine:

WARNING! Chain saws can be dangerous! Careless or incorrect use can result in serious or fatal injury to the operator or others.



Please read the operator's manual carefully and make sure you understand the instructions before using the machine.



Always wear:

- Approved protective helmet
- Approved hearing protection
- Protective goggles or a visor



This product is in accordance with applicable EC directives.



Noise emission to the environment according to the European Community's Directive. The machine's emission is specified in chapter Technical data and on label.



**Other symbols/decals on the machine refer to special certification requirements for certain markets.**

## Symbols in the operator's manual:

Switch off the engine by moving the stop switch to the STOP position before carrying out any checks or maintenance.

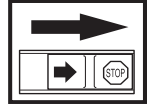

Always wear approved protective gloves.



Regular cleaning is required.

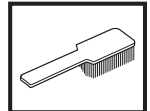

Visual check.



Protective goggles or a visor must be worn.



Refuelling.

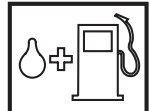

Filling with oil and adjusting oil flow.



The chain brake must be engaged when the chain saw is started.



Never let the guide bar tip come in contact with any object.



WARNING! Kickback may occur when the nose or tip of the guide bar touches an object, and cause a lightning fast reverse reaction, kicking the guide bar up and towards the operator. May cause serious personal injury.



---

# CONTENTS

---

## Contents

### KEY TO SYMBOLS

Symbols on the machine: .....	2
Symbols in the operator's manual: .....	2

### CONTENTS

Contents .....	3
----------------	---

### INTRODUCTION

Dear Customer, .....	4
----------------------	---

### WHAT IS WHAT?

What is what on the chain saw? .....	5
--------------------------------------	---

### GENERAL SAFETY PRECAUTIONS

Before using a new chain saw .....	6
Important .....	6
Always use common sense .....	6
Personal protective equipment .....	7
Machine's safety equipment .....	7
Cutting equipment .....	10

### ASSEMBLY

Fitting the bar and chain .....	15
---------------------------------	----

### FUEL HANDLING

Fuel .....	16
Fuelling .....	17
Fuel safety .....	17

### STARTING AND STOPPING

Starting and stopping .....	18
-----------------------------	----

### WORKING TECHNIQUES

Before use: .....	20
General working instructions .....	20
How to avoid kickback .....	27

### MAINTENANCE

Carburettor .....	28
Checking, maintaining and servicing chain saw safety equipment .....	29
Muffler .....	31
Starter .....	32
Air filter .....	33
Spark plug .....	33
Lubricating the bar tip sprocket .....	33
Needle bearing lubrication .....	33
Adjustment of the oil pump .....	34
Cooling system .....	34
Winter use .....	34
Maintenance schedule .....	35

### TECHNICAL DATA

Technical data .....	36
Bar and chain combinations .....	37
Saw chain filing and file gauges .....	37
EC-declaration of conformity .....	38

---

# INTRODUCTION

---

## Dear Customer,

Congratulations on your choice to buy a Husqvarna product! Husqvarna is based on a tradition that dates back to 1689, when the Swedish King Charles XI ordered the construction of a factory on the banks of the Husqvarna River, for production of muskets. The location was logical, since water power was harnessed from the Huskvarna River to create the water-powered plant. During the more than 300 years of being, the Husqvarna factory has produced a lot of different products, from wood stoves to modern kitchen appliances, sewing machines, bicycles, motorcycles etc. In 1956, the first motor driven lawn mowers appeared, followed by chain saws in 1959, and it is within this area Husqvarna is working today.

Today Husqvarna is one of the leading manufacturers in the world of forest and garden products, with quality as our highest priority. The business concept is to develop, manufacture and market motor driven products for forestry and gardening as well as for building and construction industry. Husqvarna's aim is also to be in the front edge according to ergonomics, usability, security and environmental protection. That is the reason why we have developed many different features to provide our products within these areas.

We are convinced that you will appreciate with great satisfaction the quality and performance of our product for a very long time to come. The purchase of one of our products gives you access to professional help with repairs and service whenever this may be necessary. If the retailer who sells your machine is not one of our authorised dealers, ask for the address of your nearest service workshop.

It is our wish that you will be satisfied with your product and that it will be your companion for a long time. Think of this operator's manual as a valuable document. By following its' content (using, service, maintenance etc) the life span and the second-hand value of the machine can be extended. If you will sell this machine, make sure that the buyer will get the operator's manual.

Thank you for using a Husqvarna product.

Husqvarna AB has a policy of continuous product development and therefore reserves the right to modify the design and appearance of products without prior notice.

# WHAT IS WHAT?

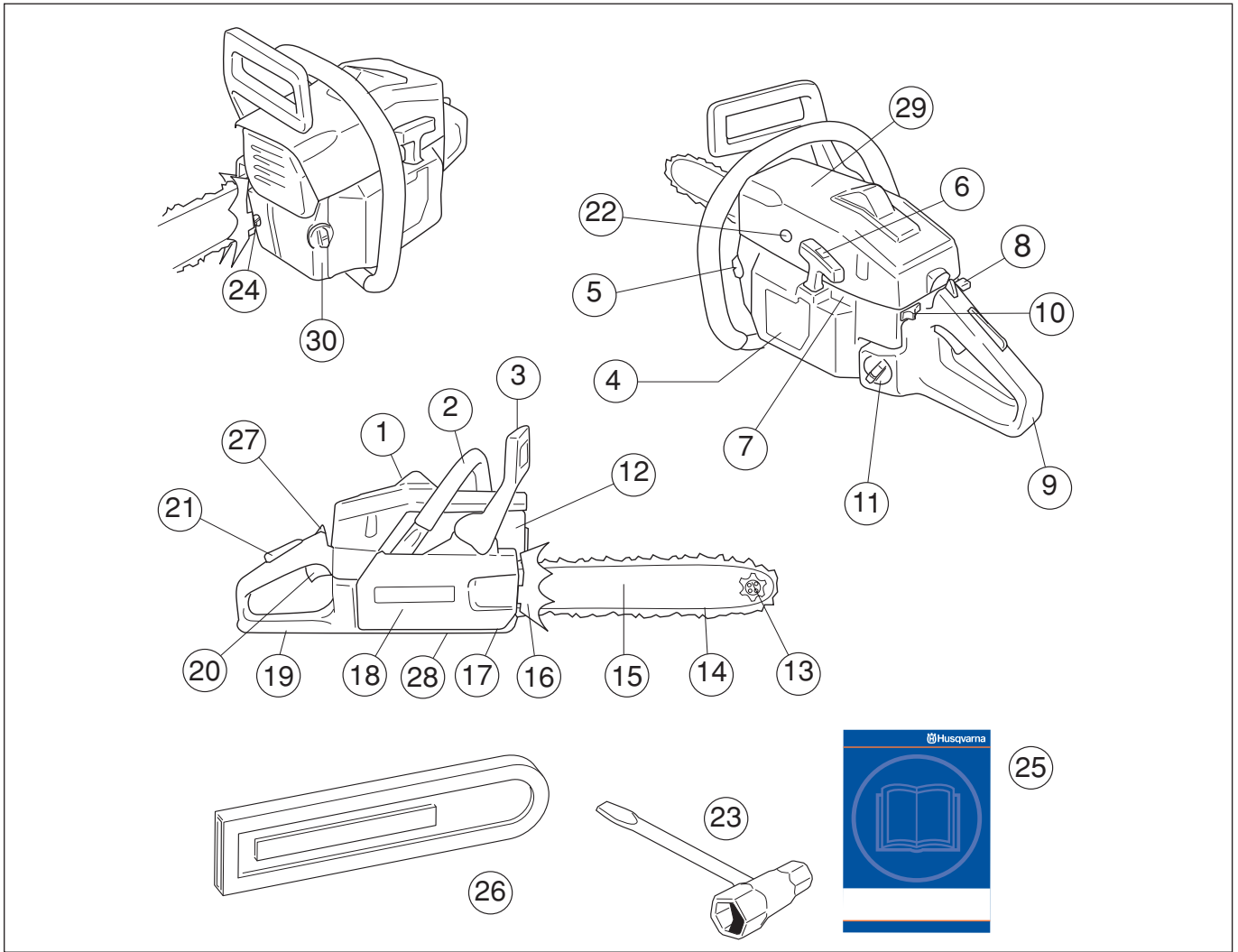

## What is what on the chain saw?

- |  |   |
|--|---|
| 1 Cylinder cover                         | 17 Chain catcher (Catches chain if it jumps or breaks.)               |
| 2 Front handle                           | 18 Clutch cover   |
| 3 Front hand guard                       | 19 Right hand guard (Protects right hand if chain breaks or jumps.)   |
| 4 Starter                                | 20 Throttle control   |
| 5 Chain oil tank                         | 21 Throttle lock (Prevents accidental operation of throttle control.) |
| 6 Starter handle                         | 22 Decompression valve (288XP)  |
| 7 Adjuster screws carburettor            | 23 Combination spanner  |
| 8 Choke control/Start throttle lock      | 24 Chain tensioning screw   |
| 9 Rear handle                            | 25 Operator's manual  |
| 10 Stop switch (Ignition on/off switch.) | 26 Bar guard  |
| 11 Fuel tank                             | 27 Start throttle lock  |
| 12 Muffler                               | 28 Oil pump adjustment screw  |
| 13 Bar tip sprocket                      | 29 Information and warning decal                                      |
| 14 Chain                                 | 30 Product and serial number plate                                    |
| 15 Bar                                   |   |
| 16 Spike bumper                          |   |

# GENERAL SAFETY PRECAUTIONS

## Before using a new chain saw

- Please read this manual carefully.
- Check that the cutting equipment is correctly fitted and adjusted. See instructions under the heading Assembly.
- Refuel and start the chain saw. See the instructions under the headings Fuel Handling and Starting and Stopping.
- Do not use the chain saw until sufficient chain oil has reached the chain. See instructions under the heading Lubricating cutting equipment.
- Long-term exposure to noise can result in permanent hearing impairment. So always use approved hearing protection.



**WARNING!** Under no circumstances may the design of the machine be modified without the permission of the manufacturer. Always use genuine accessories. Non-authorized modifications and/or accessories can result in serious personal injury or the death of the operator or others.



**WARNING!** A chain saw is a dangerous tool if used carelessly or incorrectly and can cause serious, even fatal injuries. It is very important that you read and understand the contents of this operator's manual.



**WARNING!** The inside of the muffler contain chemicals that may be carcinogenic. Avoid contact with these elements in the event of a damaged muffler.



**WARNING!** Long term inhalation of the engine's exhaust fumes, chain oil mist and dust from sawdust can represent a health risk.

## Important

### IMPORTANT!

The machine is only designed for cutting wood.

You should only use the saw with the bar and chain combinations we recommend in the chapter Technical data.

Never use the machine if you are fatigued, while under the influence of alcohol or drugs, medication or anything that could affect your vision, alertness, coordination or judgement.

Wear personal protective equipment. See instructions under the heading Personal protective equipment.

Do not modify this product or use it if it appears to have been modified by others.

Never use a machine that is faulty. Carry out the checks, maintenance and service instructions described in this manual. Some maintenance and service measures must be carried out by trained and qualified specialists. See instructions under the heading Maintenance.

Never use any accessories other than those recommended in this manual. See instructions under the headings Cutting equipment and Technical data.

**CAUTION!** Always wear protective glasses or a face visor to reduce the risk of injury from thrown objects. A chain saw is capable of throwing objects, such as wood chips, small pieces of wood, etc, at great force. This can result in serious injury, especially to the eyes.



**WARNING!** Running an engine in a confined or badly ventilated area can result in death due to asphyxiation or carbon monoxide poisoning.



**WARNING!** Faulty cutting equipment or the wrong combination of bar and saw chain increases the risk of kickback! Only use the bar/saw chain combinations we recommend, and follow the filing instructions. See instructions under the heading Technical data.

## Always use common sense

It is not possible to cover every conceivable situation you can face when using a chain saw. Always exercise care and use your common sense. Avoid all situations which you consider to be beyond your capability. If you still feel uncertain about operating procedures after reading these instructions, you should consult an expert before continuing. Do not hesitate to contact your dealer or us if you have any questions about the use of the chain saw. We will willingly be of service and provide you with advice as well as help you to use your chain saw both efficiently and safely. Attend a training course in

# GENERAL SAFETY PRECAUTIONS

chain saw usage if possible. Your dealer, forestry school or your library can provide information about which training materials and courses are available.



Work is constantly in progress to improve the design and technology - improvements that increase your safety and efficiency. Visit your dealer regularly to see whether you can benefit from new features that have been introduced.

## Personal protective equipment



**WARNING!** Most chain saw accidents happen when the chain touches the operator. You must use approved personal protective equipment whenever you use the machine. Personal protective equipment cannot eliminate the risk of injury but it will reduce the degree of injury if an accident does happen. Ask your dealer for help in choosing the right equipment.

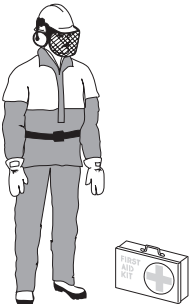

- Approved protective helmet
- Hearing protection
- Protective goggles or a visor
- Gloves with saw protection
- Trousers with saw protection
- Boots with saw protection, steel toe-cap and non-slip sole
- Always have a first aid kit nearby.
- Fire Extinguisher and Shovel

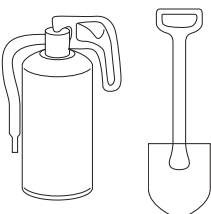

Generally clothes should be close-fitting without restricting your freedom of movement.

**IMPORTANT!** Sparks can come from the muffler, the bar and chain or other sources. Always have fire extinguishing tools available if you should need them. Help prevent forest fires.

## Machine's safety equipment

In this section the machine's safety features and their function are explained. For inspection and maintenance see instructions under the heading Checking, maintaining and servicing chain saw safety equipment. See instructions under the heading, What is what?, to find where these parts are located on your machine.

The life span of the machine can be reduced and the risk of accidents can increase if machine maintenance is not carried out correctly and if service and/or repairs are not carried out professionally. If you need further information please contact your nearest service workshop.



**WARNING!** Never use a machine with defective safety components. Safety equipment must be inspected and maintained. See instructions under the heading Checking, maintaining and servicing chain saw safety equipment. If your machine does not pass all the checks, take the saw to a servicing dealer for repair.

## Chain brake and front hand guard

Your chain saw is equipped with a chain brake that is designed to stop the chain if you get a kickback. The chain brake reduces the risk of accidents, but only you can prevent them.

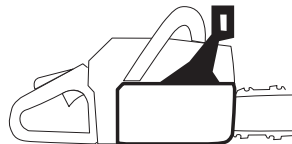

Take care when using your saw and make sure the kickback zone of the bar never touches any object.

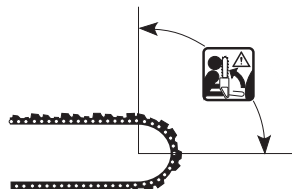

- The chain brake (A) can either be activated manually (by your left hand) or automatically by the inertia release mechanism.
- The brake is applied when the front hand guard (B) is pushed forwards.

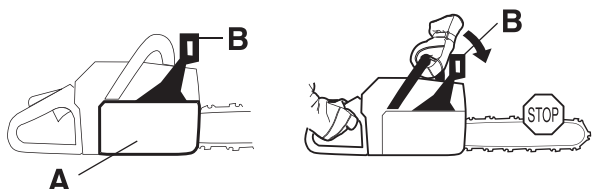

# GENERAL SAFETY PRECAUTIONS

- This movement activates a spring-loaded mechanism that tightens the brake band (C) around the engine drive system (D) (clutch drum).

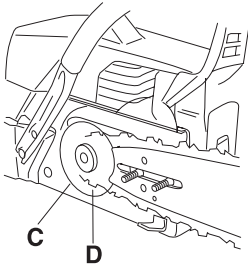

- The front hand guard is not designed solely to activate the chain brake. Another important feature is that it reduces the risk of the chain hitting your left hand if you lose grip of the front handle.

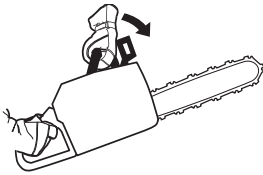

- The chain brake must be engaged when the chain saw is started to prevent the saw chain from rotating.

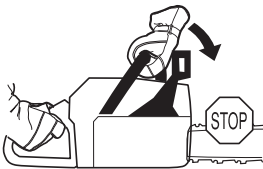

- Use the chain brake as a "parking brake" when starting and when moving over short distances, to reduce the risk of moving chain accidentally hitting your leg or anyone or anything close by.

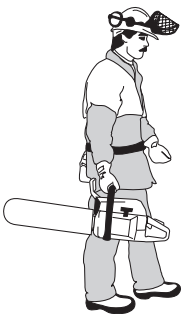

- To release the chain brake pull the front hand guard backwards, towards the front handle.



- Kickback can be very sudden and violent. Most kickbacks are minor and do not always activate the chain brake. If this happens you should hold the chain saw firmly and not let go.

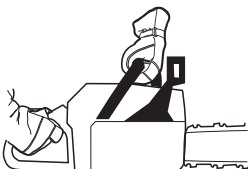

- The way the chain brake is activated, either manually or automatically by the inertia release mechanism, depends on the force of the kickback and the position of the chain saw in relation to the object that the kickback zone of the bar strikes.

If you get a violent kickback while the kickback zone of the bar is farthest away from you the chain brake is designed to be activated by the inertia in the kickback direction.

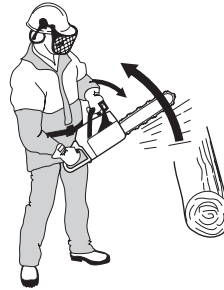

If the kickback is less violent or the kickback zone of the bar is closer to you the chain brake will be activated manually by the movement of your left hand.

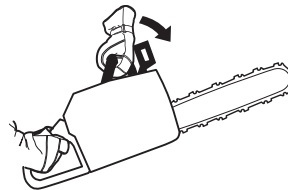

- In the felling position the left hand is in a position that makes manual activation of the chain brake impossible. With this type of grip, that is when the left hand is placed so that it cannot affect the movement of the front hand guard, the chain brake can only be activated by the inertia action.



## Will my hand always activate the chain brake during a kickback?

No. It takes a certain force to move the hand guard forward. If your hand only lightly touches the front guard or slips over it, the force may not be enough to trigger the chain brake. You should also maintain a firm grip of the chain saw handles while working. If you do and experience a kickback, your hand may never leave the front handle and will not activate the chain brake, or the chain brake will only activate after the saw has swung around a considerable distance. In such instances, the chain brake might not have enough time to stop the saw chain before it touches you.

There are also certain positions in which your hand cannot reach the front hand guard to activate the chain brake; for example, when the saw chain is held in felling position.



# GENERAL SAFETY PRECAUTIONS

## Will my inertia activated chain brake always activate during kickback in the event of a kickback?

No. First your brake must be in working order. Testing the brake is simple, see instructions under the heading Checking, maintaining and servicing chain saw safety equipment. We recommend you do before you begin each work session. Second the kickback must be strong enough to activate the chain brake. If the chain brake is too sensitive it would activate all the time which would be a nuisance.

## Will my chain brake always protect me from injury in the event of a kickback?

No. First, the chain brake must be in working order to provide the intended protection. Second, it must be activated during the kickback as described above to stop the saw chain. Third, the chain brake may be activated but if the bar is too close to you the brake might not have enough time to slow down and stop the chain before the chain saw hits you.

**Only you and proper working technique can eliminate kickback and its danger.**

## Throttle lock

The throttle lock is designed to prevent accidental operation of the throttle control. When you press the lock (A) (i.e. when you grasp the handle) it releases the throttle control (B). When you release the handle the throttle control and the throttle lock both move back to their original positions. This arrangement means that the throttle control is automatically locked at the idle setting.

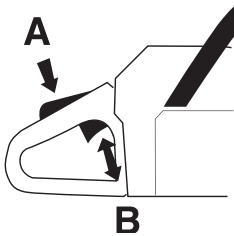

## Chain catcher

The chain catcher is designed to catch the chain if it snaps or jumps off. This should not happen if the chain is properly tensioned (see instructions under the heading Assembly) and if the bar and chain are properly serviced and maintained (see instructions under the heading General working instructions).

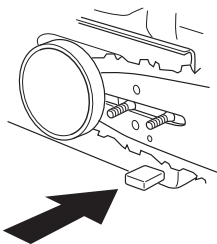

## Right hand guard

Apart from protecting your hand if the chain jumps or snaps, the right hand guard stops branches and twigs from interfering with your grip on the rear handle.

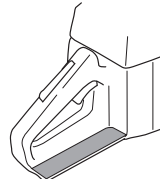

## Vibration damping system

Your machine is equipped with a vibration damping system that is designed to minimize vibration and make operation easier.



The machine's vibration damping system reduces the transfer of vibration between the engine unit/cutting equipment and the machine's handle unit.

The body of the chain saw, including the cutting equipment, is insulated from the handles by vibration damping units.

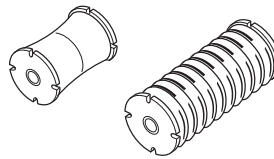

Cutting hardwoods (most broadleaf trees) creates more vibration than cutting softwoods (most conifers). Cutting with cutting equipment that is blunt or faulty (wrong type or badly sharpened) will increase the vibration level.



**WARNING! Overexposure to vibration can lead to circulatory damage or nerve damage in people who have impaired circulation. Contact your doctor if you experience symptoms of overexposure to vibration. Such symptoms include numbness, loss of feeling, tingling, pricking, pain, loss of strength, changes in skin colour or condition. These symptoms normally appear in the fingers, hands or wrists. These symptoms may be increased in cold temperatures.**

## Stop switch

Use the stop switch to switch off the engine.

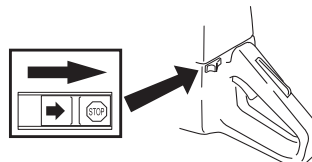

# GENERAL SAFETY PRECAUTIONS

## Muffler

The muffler is designed to keep noise levels to a minimum and to direct exhaust fumes away from the user.



**WARNING!** The exhaust fumes from the engine are hot and may contain sparks which can start a fire. Never start the machine indoors or near combustible material!

In areas with a hot, dry climate there is a high risk of fires. These areas are sometimes subject to government rules requiring among other things the muffler must be equipped with an approved type of spark arrestor mesh.

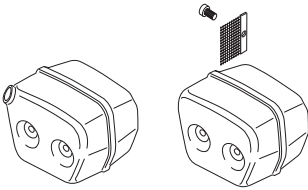

**CAUTION!** The muffler gets very hot during and after use. This also applies during idling. Be aware of the fire hazard, especially when working near flammable substances and/or vapours.



**WARNING!** Never use a saw without a muffler, or with a damaged muffler. A damaged muffler may substantially increase the noise level and the fire hazard. Keep fire fighting equipment handy. If a spark arrestor screen is required in your area, never use the saw without or with a broken spark arrestor screen.

## Cutting equipment

This section describes how to choose and maintain your cutting equipment in order to:

- Reduce the risk of kickback.
- Reduce the risk of the saw chain breaking or jumping off the bar.
- Obtain optimal cutting performance.
- Extend the life of cutting equipment.
- Avoid increasing vibration levels.

### General rules

- **Only use cutting equipment recommended by us!** See instructions under the heading Technical data.

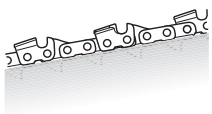

- **Keep the chain's cutting teeth properly sharpened! Follow our instructions and use the recommended file gauge.** A damaged or badly sharpened chain increases the risk of accidents.



- **Maintain the correct depth gauge setting! Follow our instructions and use the recommended depth gauge clearance.** Too large a clearance increases the risk of kickback.

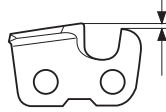

- **Keep the chain properly tensioned!** If the chain is slack it is more likely to jump off and lead to increased wear on the bar, chain and drive sprocket.



- **Keep cutting equipment well lubricated and properly maintained!** A poorly lubricated chain is more likely to break and lead to increased wear on the bar, chain and drive sprocket.



## Cutting equipment designed to reduce kickback



**WARNING!** Faulty cutting equipment or the wrong combination of bar and saw chain increases the risk of kickback! Only use the bar/saw chain combinations we recommend, and follow the filing instructions. See instructions under the heading Technical data.

The only way to avoid kickback is to make sure that the kickback zone of the bar never touches anything.

By using cutting equipment with "built-in" kickback reduction and keeping the chain sharp and well-maintained you can reduce the effects of kickback.

### Bar

The smaller the tip radius the lower the chance of kickback.

### Chain

A chain is made up of a number of links, which are available in standard and low-kickback versions.

**IMPORTANT!** No saw chain design eliminates the danger of kickback.



**WARNING!** Any contact with a rotating saw chain can cause extremely serious injuries.

## Some terms that describe the bar and chain

To maintain the safety features of the cutting equipment, you should replace a worn or damaged bar or chain with a bar and chain combinations recommended by Husqvarna. See instructions under the heading Technical Data for a list of replacement bar and chain combinations we recommend.

# GENERAL SAFETY PRECAUTIONS

## Bar

- Length (inches/cm)

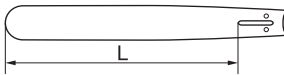

- Number of teeth on bar tip sprocket (T).

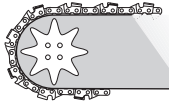

- Chain pitch (inches). The spacing between the drive links of the chain must match the spacing of the teeth on the bar tip sprocket and drive sprocket.

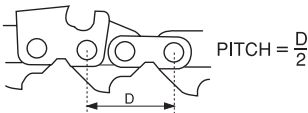

- Number of drive links. The number of drive links is determined by the length of the bar, the chain pitch and the number of teeth on the bar tip sprocket.



- Bar groove width (inches/mm). The groove in the bar must match the width of the chain drive links.



- Chain oil hole and hole for chain tensioner. The bar must be matched to the chain saw design.

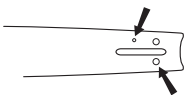

## Chain

- Chain pitch (inches)

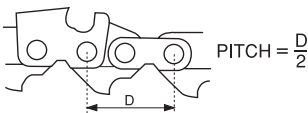

- Drive link width (mm/inches)

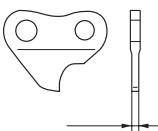

- Number of drive links.

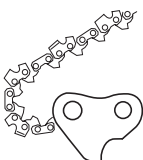

## Sharpening your chain and adjusting depth gauge setting

### General information on sharpening cutting teeth

- Never use a blunt chain. When the chain is blunt you have to exert more pressure to force the bar through the wood and the chips will be very small. If the chain is very blunt it will produce wood powder and no chips or shavings.
- A sharp chain eats its way through the wood and produces long, thick chips or shavings.

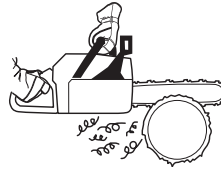

- The cutting part of the chain is called the cutter and consists of a cutting tooth (A) and the depth gauge (B). The cutters cutting depth is determined by the difference in height between the two (depth gauge setting).

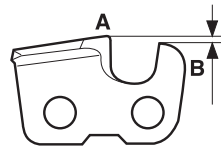

When you sharpen a cutting tooth there are four important factors to remember.

- 1 Filing angle

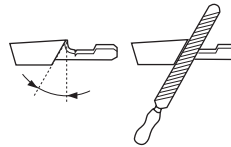

- 2 Cutting angle

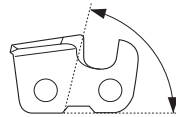

- 3 File position

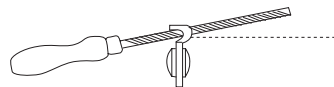

- 4 Round file diameter

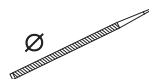

It is very difficult to sharpen a chain correctly without the right equipment. We recommend that you use our file gauge. This will help you obtain the maximum kickback reduction and cutting performance from your chain.

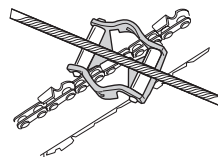

See instructions under the heading Technical data for information about sharpening your chain.



**WARNING! Departure from the sharpening instructions considerably increases the risk of kickback.**

# GENERAL SAFETY PRECAUTIONS

## Sharpening cutting teeth



To sharpen cutting teeth you will need a round file and a file gauge. See instructions under the heading Technical data for information on the size of file and gauge that are recommended for the chain fitted to your chain saw.

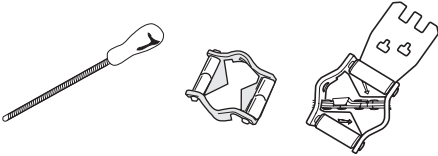

- Check that the chain is correctly tensioned. A slack chain will move sideways, making it more difficult to sharpen correctly.



- Always file cutting teeth from the inside face. Reduce the pressure on the return stroke. File all the teeth on one side first, then turn the chain saw over and file the teeth on the other side.

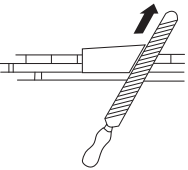

- File all the teeth to the same length. When the length of the cutting teeth is reduced to 4 mm (0.16") the chain is worn out and should be replaced.

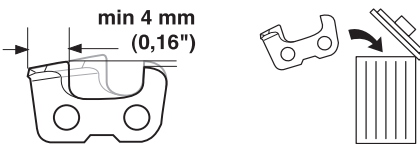

## General advice on adjusting depth gauge setting

- When you sharpen the cutting tooth (A) the depth gauge setting (C) will decrease. To maintain optimal cutting performance the depth gauge (B) has to be filed down to achieve the recommended depth gauge setting.

See instructions under the heading Technical data to find the correct depth gauge setting for your particular chain.

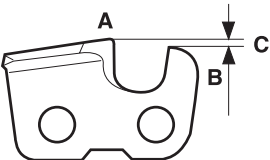

**WARNING! The risk of kickback is increased if the depth gauge setting is too large!**

## Adjustment of depth gauge setting

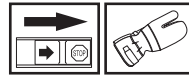

- The cutting teeth should be newly sharpened before adjusting the depth gauge setting. We recommend that you adjust the depth gauge setting every third time you sharpen the cutting teeth. NOTE! This recommendation assumes that the length of the cutting teeth is not reduced excessively.
- You will need a flat file and a depth gauge tool. We recommend that you use our depth gauge tool to achieve the correct depth gauge setting and bevel for the depth gauge.

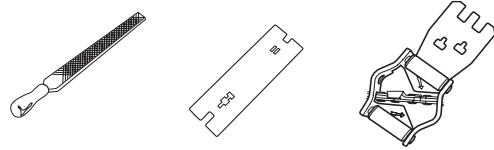

- Place the depth gauge tool over the chain. Detailed information regarding the use of the depth gauge tool, will be found on the package for the depth gauge tool. Use the flat file to file off the tip of the depth gauge that protrudes through the depth gauge tool. The depth gauge setting is correct when you no longer feel resistance as you draw the file along the depth gauge tool.

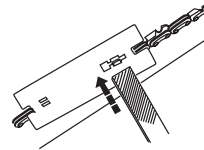

## Tensioning the chain

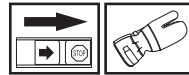

**WARNING! A slack chain may jump off and cause serious or even fatal injury.**

The more you use a chain the longer it becomes. It is therefore important to adjust the chain regularly to take up the slack.

Check the chain tension every time you refuel. NOTE! A new chain has a running-in period during which you should check the tension more frequently.

Tension the chain as tightly as possible, but not so tight that you cannot pull it round freely by hand.

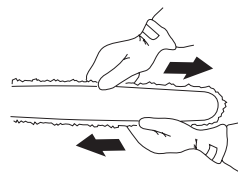

- Undo the bar nuts that hold the clutch cover/chain brake. Use the combination spanner. Then tighten the bar nuts by hand as tight as you can.

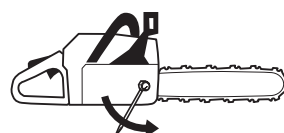

# GENERAL SAFETY PRECAUTIONS

- Raise the tip of the bar and stretch the chain by tightening the chain tensioning screw using the combination spanner. Tighten the chain until it does not sag from the underside of the bar.

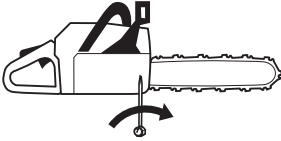

- Use the combination spanner to tighten the bar nuts while lifting the tip of the bar at the same time. Check that you can pull the chain round freely by hand and that it does not sag from the underside of the bar.



The position of the chain tensioning screw on our chain saws varies from model to model. See instructions under the heading What is what? to find out where it is on your model.

## Lubricating cutting equipment



**WARNING! Poor lubrication of cutting equipment may cause the chain to snap, which could lead to serious, even fatal injuries.**

### Chain oil

Chain oil must demonstrate good adhesion to the chain and also maintain its flow characteristics regardless of whether it is warm summer or cold winter weather.

As a chain saw manufacturer we have developed an optimal chain oil which, with its vegetable oil base, is also biodegradable. We recommend the use of our own oil for both maximum chain life and to minimise environmental damage. If our own chain oil is not available, standard chain oil is recommended.

**Never use waste oil!** Using waste oil can be dangerous to you and damage the machine and environment.

**IMPORTANT!** When using vegetable based saw chain oil, dismantle and clean the groove in the bar and saw chain before long-term storage. Otherwise there is a risk of the saw chain oil oxidizing, which will result in the saw chain becoming stiff and the bar tip sprocket jamming.

### Filling with chain oil

- All our chain saws have an automatic chain lubrication system. On some models the oil flow is also adjustable.

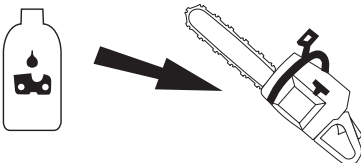

- The saw chain oil tank and the fuel tank are designed so that the fuel runs out before the saw chain oil. However, this safety feature requires that you use the right sort of chain oil (if the oil is too thin it will run out before the fuel), and that you adjust the carburetor as recommended

(a lean mixture may mean that the fuel lasts longer than the oil) and that you also use the recommended cutting equipment (a bar that is too long will use more chain oil).

### Checking chain lubrication

- Check the chain lubrication each time you refuel. See instructions under the heading Lubricating the bar tip sprocket.

Aim the tip of the bar at a light coloured surface about 20 cm (8 inches) away. After 1 minute running at 3/4 throttle you should see a distinct line of oil on the light surface.



If the chain lubrication is not working:

- Check that the oil channel in the bar is not obstructed. Clean if necessary.

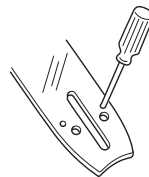

- Check that the groove in the edge of the bar is clean. Clean if necessary.

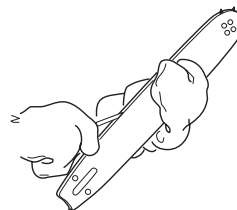

- Check that the bar tip sprocket turns freely and that the lubricating hole in the tip sprocket is not blocked. Clean and lubricate if necessary.



If the chain lubrication system is still not working after carrying out the above checks and associated measures you should contact your service agent.

# GENERAL SAFETY PRECAUTIONS

## Chain drive sprocket

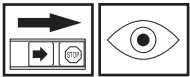

The clutch drum is fitted with one of the following drive sprockets:

A Spur sprocket (the chain sprocket is welded on the drum)

B Rim sprocket (replaceable)

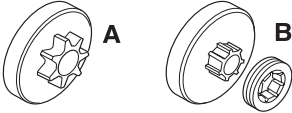

Regularly check the degree of wear on the drive sprocket. Replace if wear is excessive. Replace the drive sprocket whenever you replace the chain.

## Needle bearing lubrication



Both versions of sprockets have a needle bearing on the drive shaft, which has to be greased regularly (once a week). **CAUTION!** Use a high-quality bearing grease or engine oil.

See instructions under the heading Maintenance, Needle bearing lubrication.

## Checking wear on cutting equipment



Check the chain daily for:

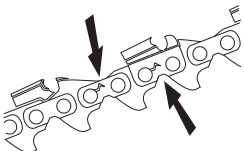

- Visible cracks in rivets and links.
- Whether the chain is stiff.
- Whether rivets and links are badly worn.

Replace the saw chain if it exhibits any of the points above.

We recommend you compare the existing chain with a new chain to decide how badly the existing chain is worn.

When the length of the cutting teeth has worn down to only 4 mm the chain must be replaced.

## Bar

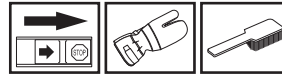

Check regularly:

- Whether there are burrs on the edges of the bar. Remove these with a file if necessary.

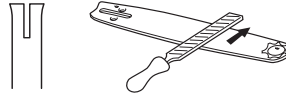

- Whether the groove in the bar has become badly worn. Replace the bar if necessary.



- Whether the tip of the bar is uneven or badly worn. If a hollow forms on the underside of the bar tip this is due to running with a slack chain.

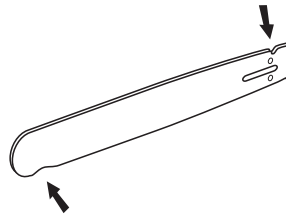

- To prolong the life of the bar you should turn it over daily.



**WARNING!** Most chain saw accidents happen when the chain touches the operator.

**Wear personal protective equipment. See instructions under the heading Personal protective equipment.**

**Do not tackle any job that you feel you are not adequately trained for. See instructions under the headings Personal protective equipment, How to avoid kickback, Cutting equipment and General working instructions.**

**Avoid situations where there is a risk of kickback. See instructions under the heading Machine's safety equipment.**

**Use the recommended protective equipment and check its condition. See instructions under the heading General working instructions.**

**Check that all the chain saw safety features are working. See instructions under the headings General working instructions and General safety precautions.**



# ASSEMBLY

## Fitting the bar and chain

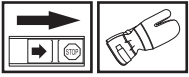

**WARNING! Always wear gloves, when working with the chain.**

Check that the chain brake is in disengaged position by moving the front hand guard towards the front handle.

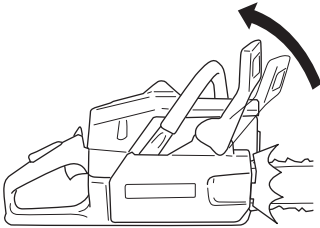

Remove the bar nuts and remove the clutch cover (chain brake). Take off the transportation ring (A).

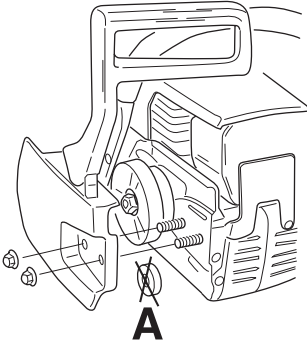

Fit the bar over the bar bolts. Place the bar in its rearmost position. Place the chain over the drive sprocket locate it in the groove on the bar. Begin on the top edge of the bar. Make sure that the edges of the cutting links are facing forward on the top edge of the bar.

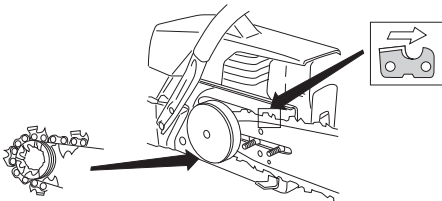

Fit the clutch cover and locate the chain adjuster pin in the hole in the bar. Check that the drive links of the chain fit correctly over the drive sprocket and that the chain is correctly located in the groove in the bar. Tighten the bar nuts finger tight.

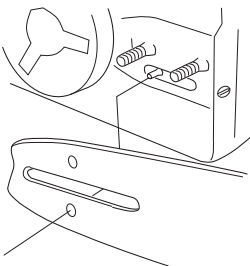

Tension the chain by turning the chain tensioning screw clockwise using the combination spanner. The chain should be tensioned until it does not sag from the underside of the bar.

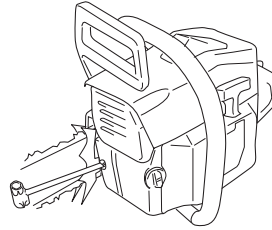

The chain is correctly tensioned when it does not sag from the underside of the bar, but can still be turned easily by hand. Hold up the bar tip and tighten the bar nuts with the combination spanner.

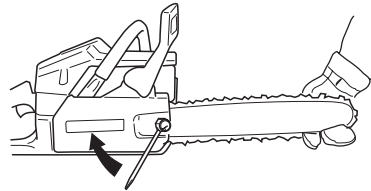

When fitting a new chain, the chain tension has to be checked frequently until the chain is run-in. Check the chain tension regularly. A correctly tensioned chain ensures good cutting performance and long life.

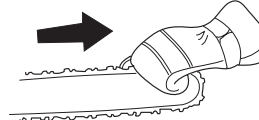

## Fitting a spike bumper

To fit a spike bumper – contact your service agent.

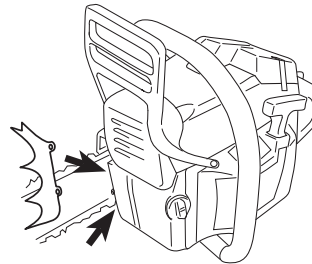

# FUEL HANDLING

## Fuel

Note! The machine is equipped with a two-stroke engine and must always be run using a mixture of petrol and two-stroke oil. It is important to accurately measure the amount of oil to be mixed to ensure that the correct mixture is obtained. When mixing small amounts of fuel, even small inaccuracies can drastically affect the ratio of the mixture.



## Petrol



- Use good quality unleaded or leaded petrol.
- **CAUTION! Engines equipped with catalytic converters must be run on unleaded fuel mixtures.**
- Leaded gasoline will destroy the catalytic converter and it will no longer serve its purpose. The green fuel cap on saws fitted with catalytic converters means that only unleaded gasoline can be used.
- The lowest recommended octane grade is 90 (RON). If you run the engine on a lower octane grade than 90 so-called knocking can occur. This gives rise to a high engine temperature and increased bearing load, which can result in serious engine damage.
- When working with continuous high revs (e.g. limbing) a higher octane is recommended.

## Environment fuel

HUSQVARNA recommends the use of alkylate fuel, either Aspen two-stroke fuel or environment fuel for four-stroke engines blended with two-stroke oil as set out below. Note that carburettor adjustment may be necessary when changing the type of fuel (see the instructions under the heading Carburettor).

## Running-in

Avoid running at a too high speed for extended periods during the first 10 hours.

## Two-stroke oil

- For best results and performance use HUSQVARNA two-stroke engine oil, which is specially formulated for our air-cooled two-stroke engines.
- Never use two-stroke oil intended for water-cooled engines, sometimes referred to as outboard oil (rated TCW).
- Never use oil intended for four-stroke engines.
- A poor oil quality and/or too high oil/fuel ratio may jeopardise function and decrease the life time of catalytic converters.

## Mixing ratio

1:50 (2%) with HUSQVARNA two-stroke oil.

1:33 (3%) with oils class JASO FB or ISO EGB formulated for air-cooled, two-stroke engines.

Petrol, litre	Two-stroke oil, litre	
	2% (1:50)	3% (1:33)
5	0,10	0,15
10	0,20	0,30
15	0,30	0,45
20	0,40	0,60

## Mixing

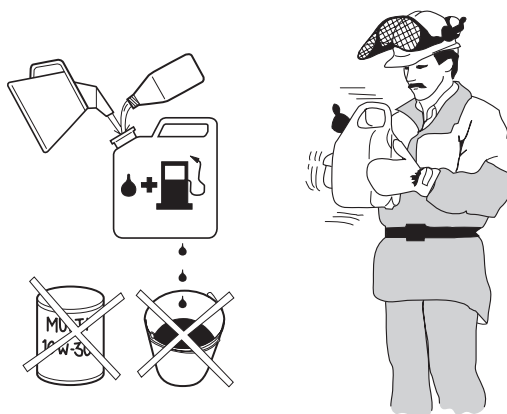

- Always mix the petrol and oil in a clean container intended for fuel.
- Always start by filling half the amount of the petrol to be used. Then add the entire amount of oil. Mix (shake) the fuel mixture. Add the remaining amount of petrol.
- Mix (shake) the fuel mixture thoroughly before filling the machine's fuel tank.
- Do not mix more than one month's supply of fuel at a time.
- If the machine is not used for some time the fuel tank should be emptied and cleaned.

## Chain oil

- We recommend the use of special oil (chain oil) with good adhesion characteristics.

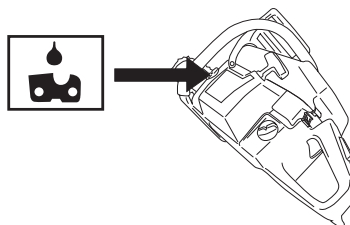

- Never use waste oil. This results in damage to the oil pump, the bar and the chain.
- It is important to use oil of the right grade (suitable viscosity range) to suit the air temperature.
- In temperatures below 0°C (32°F) some oils become too viscous. This can overload the oil pump and result in damage to the oil pump components.
- Contact your service agent when choosing chain oil.



# FUEL HANDLING

## Fuelling



**WARNING! Taking the following precautions, will lessen the risk of fire:**

**Do not smoke and do not place any hot objects in the vicinity of fuel.**

**Always stop the engine and let it cool for a few minutes before refuelling.**

**When refuelling, open the fuel cap slowly so that any excess pressure is released gently.**

**Tighten the fuel cap carefully after refuelling.**

**Always move the machine away from the refuelling area before starting.**

Clean the area around the fuel cap. Clean the fuel and chain oil tanks regularly. The fuel filter must be replaced at least once a year. Contamination in the tanks causes malfunction. Make sure the fuel is well mixed by shaking the container before refuelling. The capacities of the chain oil tank and fuel tank are carefully matched. You should therefore always fill the chain oil tank and fuel tank at the same time.

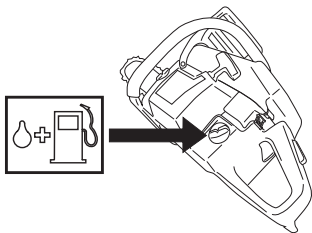

**WARNING! Fuel and fuel vapour are highly flammable. Take care when handling fuel and chain oil. Be aware of the risks of fire, explosion and those associated with inhalation.**

## Fuel safety

- Never refuel the machine while the engine is running.
- Make sure there is plenty of ventilation when refuelling or mixing fuel (petrol and 2-stroke oil).
- Move the machine at least 3 m from the refuelling point before starting it.

**Min. 3 m  
(10 ft)**

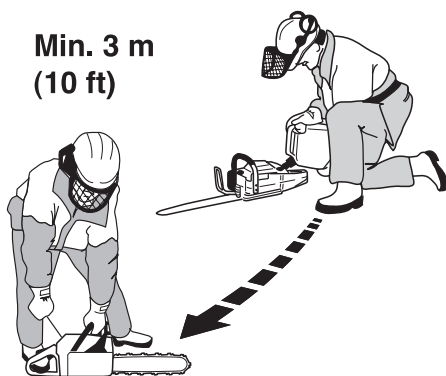

- Never start the machine:
  - 1 If you have spilt fuel or chain oil on the machine. Wipe off the spillage and allow remaining fuel to evaporate.
  - 2 If you have spilt fuel on yourself or your clothes, change your clothes. Wash any part of your body that has come in contact with fuel. Use soap and water.
  - 3 If the machine is leaking fuel. Check regularly for leaks from the fuel cap and fuel lines.



**WARNING! Never use a machine with visible damage to the spark plug guard and ignition cable. A risk of sparking arises, which can cause a fire.**

## Transport and storage

- Always store the chain saw and fuel so that there is no risk of leakages or fumes coming into contact with sparks or naked flames from electrical equipment, electric motors, relays/switches, boilers and the like.
- Always store fuel in an approved container designed for that purpose.
- For longer periods of storage or for transport of the chain saw, the fuel and chain oil tanks should be emptied. Ask where you can dispose of waste fuel and chain oil at your local petrol station.
- Ensure the machine is cleaned and that a complete service is carried out before long-term storage.
- The bar guard must always be fitted to the cutting attachment when the machine is being transported or in storage, in order to prevent accident contact with the sharp chain. Even a non-moving chain can cause serious cuts to yourself or persons you bump into with an exposed chain.

## Long-term storage

Empty the fuel/oil tanks in a well ventilated area. Store the fuel in approved cans in a safe place. Fit the bar guard. Clean the machine. See instructions under the heading Maintenance schedule.

# STARTING AND STOPPING

## Starting and stopping



**WARNING!** Note the following before starting:

Never start a chain saw unless the bar, chain and all covers are fitted correctly. Otherwise the clutch can come loose and cause personal injuries.

Always move the machine away from the refuelling area before starting.

Place the machine on firm ground. Make sure you have a secure footing and that the chain cannot touch anything.

Keep people and animals well away from the working area.

## Cold engine

**Starting:** The chain brake must be engaged when the chain saw is started. Activate the brake by moving the front hand guard forwards.

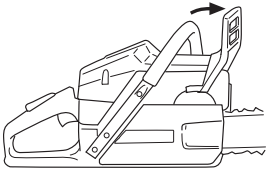

**Ignition; choke:** Set the choke control in the choke position. This should automatically set the stop switch to the start position.

**Start throttle:** The correct choke/start throttle setting is obtained by moving the control to the choke position.

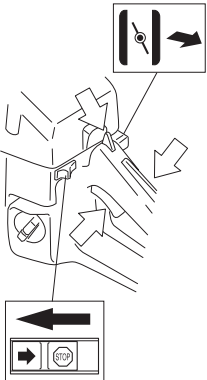

(288XP)

If the machine is fitted with a decompression valve (A): Press the valve to reduce the pressure in the cylinder and make starting easier. You should always use the decompression valve when starting the machine. Once the machine has started the valve will automatically return to its original setting.

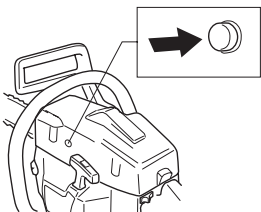

## Warm engine

Use the same starting procedure as for a cold engine but without setting the choke control in the choke position.

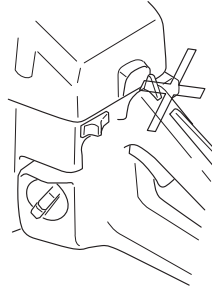

## Starting



Grip the front handle with your left hand. Hold the chain saw on the ground by placing your right foot through the rear handle. Pull the starter handle with your right hand and pull out the starter cord slowly until you feel a resistance (as the starter pawls engage) then pull firmly and rapidly. **Never twist the starter cord around your hand.**



As the chain brake is still engaged the speed of the engine must be set to idling as soon as possible, this is achieved by quickly disengaging the throttle lock. This prevents unnecessary wear to the clutch, clutch drum and brake band.

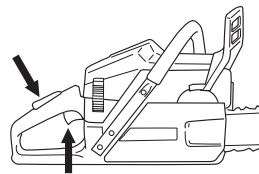

Push in the choke control as soon as the engine fires and keep pulling until the engine starts. When the engine starts, quickly apply full throttle; the throttle start lock will automatically disengage.

**CAUTION!** Do not pull the starter cord all the way out and do not let go of the starter handle when the cord is fully extended. This can damage the machine.

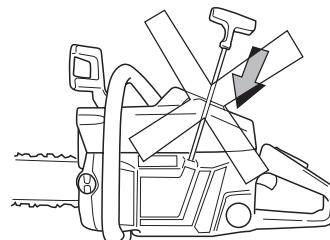

# STARTING AND STOPPING

Reactivate the chain brake by pushing the front hand guard back towards the front handle. The chain saw is now ready for use.

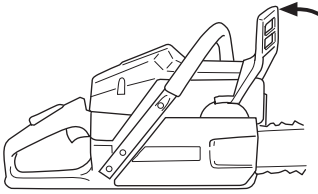

**WARNING! Long term inhalation of the engine's exhaust fumes, chain oil mist and dust from sawdust can represent a health risk.**

- Never start a chain saw unless the bar, chain and all covers are fitted correctly. See instructions under the heading Assembly. Without a bar and chain attached to the chain saw the clutch can come loose and cause serious injury.



- The chain brake should be activated when starting. See instructions under the heading Start and stop. Do not drop start. This method is very dangerous because you may lose control of the saw.

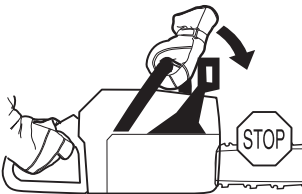

- Never start the machine indoors. Exhaust fumes can be dangerous if inhaled.
- Observe your surroundings and make sure that there is no risk of people or animals coming into contact with the cutting equipment.



- Always hold the saw with both hands. The right hand should be on the rear handle, and the left hand on the front handle. All people, whether right or left handed, should use this grip. Use a firm grip with thumbs and fingers encircling the chain saw handles.



## Stopping

The engine is stopped by pushing the stop switch to the stop position.

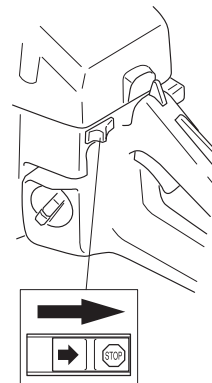

# WORKING TECHNIQUES

## Before use:

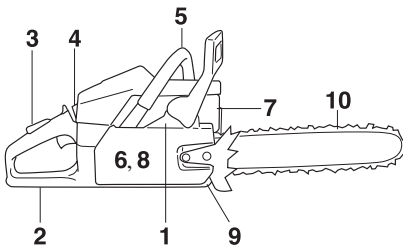

- 1 Check that the chain brake works correctly and is not damaged.
- 2 Check that the rear right hand guard is not damaged.
- 3 Check that the throttle lock works correctly and is not damaged.
- 4 Check that the stop switch works correctly and is not damaged.
- 5 Check that all handles are free from oil.
- 6 Check that the anti vibration system works and is not damaged.
- 7 Check that the muffler is securely attached and not damaged.
- 8 Check that all parts of the chain saw are tightened correctly and that they are not damaged or missing.
- 9 Check that the chain catcher is in place and not damaged.
- 10 Check the chain tension.

## General working instructions

### IMPORTANT!

This section describes basic safety rules for using a chain saw. This information is never a substitute for professional skills and experience. If you get into a situation where you feel unsafe, stop and seek expert advice. Contact your chain saw dealer, service agent or an experienced chain saw user. Do not attempt any task that you feel unsure of!

Before using a chain saw you must understand the effects of kickback and how to avoid them. See instructions under the heading How to avoid kickback.

Before using a chain saw you must understand the difference between cutting with the top and bottom edges of the bar. See instructions under the headings How to avoid kickback and Machine's safety equipment.

Wear personal protective equipment. See instructions under the heading Personal protective equipment.

## Basic safety rules

- 1 Look around you:
  - To ensure that people, animals or other things cannot affect your control of the machine.
  - To make sure that none of the above might come within reach of your saw or be injured by falling trees.

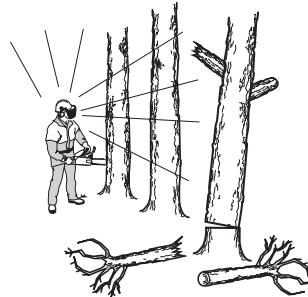

**CAUTION!** Follow the instructions above, but do not use a chain saw in a situation where you cannot call for help in case of an accident.

- 2 Do not use the machine in bad weather, such as dense fog, heavy rain, strong wind, intense cold, etc. Working in bad weather is tiring and often brings added risks, such as icy ground, unpredictable felling direction, etc.
- 3 Take great care when removing small branches and avoid cutting bushes (i.e. cutting many small branches at the same time). Small branches can be grabbed by the chain and thrown back at you, causing serious injury.

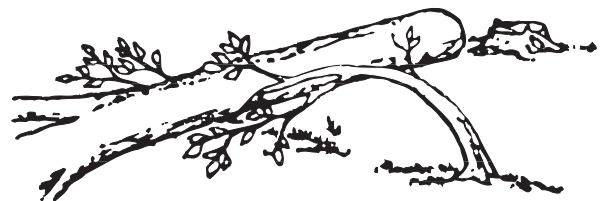

- 4 Make sure you can move and stand safely. Check the area around you for possible obstacles (roots, rocks, branches, ditches, etc.) in case you have to move suddenly. Take great care when working on sloping ground.



- 5 Take great care when cutting a tree that is in tension. A tree that is in tension may spring back to its normal position before or after being cut. If you position yourself

# WORKING TECHNIQUES

incorrectly or make the cut in the wrong place the tree may hit you or the machine and cause you to lose control. Both situations can cause serious personal injury.



- 6 Before moving your chain saw switch off the engine and lock the chain using the chain brake. Carry the chain saw with the bar and chain pointing backwards. Fit a guard to the bar before transporting the chain saw or carrying it for any distance.

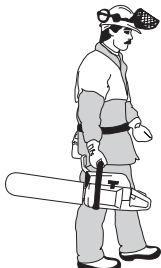

- 7 When you put the chain saw on the ground, lock the saw chain using the chain brake and ensure you have a constant view of the machine. Switch the engine off before leaving your chain saw for any length of time.

## General rules

- 1 If you understand what kickback is and how it happens then you can reduce or eliminate the element of surprise. By being prepared you reduce the risk. Kickback is usually quite mild, but it can sometimes be very sudden and violent.
- 2 Always hold the chain saw firmly with your right hand on the rear handle and your left hand on the front handle. Wrap your fingers and thumbs around the handles. You should use this grip whether you are right-handed or left-handed. This grip minimises the effect of kickback and lets you keep the chain saw under control. **Do not let go of the handles!**

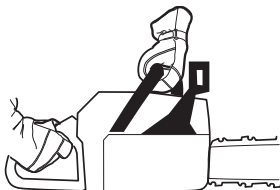

- 3 Most kickback accidents happen during limbing. Make sure you are standing firmly and that there is nothing in the way that might make you trip or lose your balance.

Lack of concentration can lead to kickback if the kickback zone of the bar accidentally touches a branch, nearby tree or some other object.

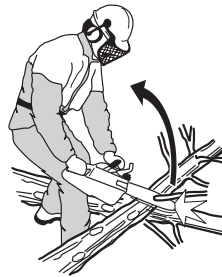

Have control over the workpiece.

If the pieces you intend to cut are small and light, they can jam in the saw chain and be thrown towards you. Even if this does not need to be a danger, you may be surprised and lose control of the saw. Never saw stacked logs or branches without first separating them. Only saw one log or one piece at a time. Remove the cut pieces to keep your working area safe.

- 4 **Never use the chain saw above shoulder height and try not to cut with the tip of the bar. Never use the chain saw one-handed!**



- 5 You must have a steady stance in order to have full control over the chain saw. Never work standing on a ladder, in a tree or where you do not have firm ground to stand on.



- 6 Always use a fast cutting speed, i.e. full throttle.

# WORKING TECHNIQUES

- 7 Take great care when you cut with the top edge of the bar, i.e. when cutting from the underside of the object. This is known as cutting on the push stroke. The chain tries to push the chain saw back towards the user. If the saw chain is jamming, the saw may be pushed back at you.

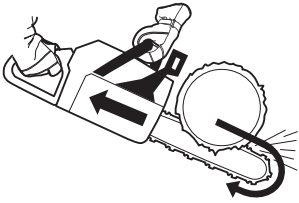

- 8 Unless the user resists this pushing force there is a risk that the chain saw will move so far backwards that only the kickback zone of the bar is in contact with the tree, which will lead to a kickback.



Cutting with the bottom edge of the bar, i.e. from the top of the object downwards, is known as cutting on the pull stroke. In this case the chain saw pulls itself towards the tree and the front edge of the chain saw body rests naturally on the trunk when cutting. Cutting on the pull stroke gives the operator better control over the chain saw and the position of the kickback zone.

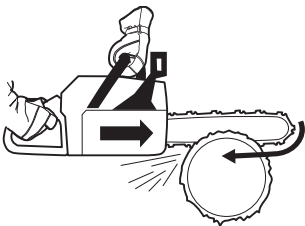

- 9 Follow the instructions on sharpening and maintaining your bar and chain. When you replace the bar and chain use only combinations that are recommended by us. See instructions under the headings Cutting equipment and Technical data.

## Basic cutting technique



**WARNING! Never use a chain saw by holding it with one hand. A chain saw is not safely controlled with one hand. Always have a secure, firm grip around the handles with both hands.**

### General

- Always use full throttle when cutting!
- Reduce the speed to idle after every cut (running the engine for too long at full throttle without any load, i.e. without any resistance from the chain during cutting, can lead to serious engine damage).
- Cutting from above = Cutting on the pull stroke.
- Cutting from below = Cutting on the push stroke.

Cutting on the push stroke increases the risk of kickback. See instructions under the heading How to avoid kickback.

### Terms

Cutting = General term for cutting through wood.

Limbing = Cutting branches off a felled tree.

Splitting = When the object you are cutting breaks off before the cut is complete.

### There are five important factors you should consider before making a cut:

- 1 Make sure the cutting equipment will not jam in the cut.



- 2 Make sure the object you are cutting will not split.



- 3 Make sure the chain will not strike the ground or any other object during or after cutting.



- 4 Is there a risk of kickback?

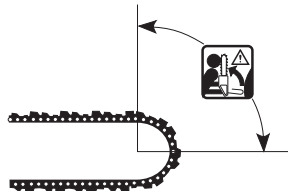

- 5 Do the conditions and surrounding terrain affect how safely you can stand and move about?

Two factors decide whether the chain will jam or the object that you are cutting will split: the first is how the object is supported before and after cutting, and the second is whether it is in tension.

In most cases you can avoid these problems by cutting in two stages; from the top and from the bottom. You need to support the object so that it will not trap the chain or split during cutting.

**IMPORTANT! If the chain jams in the cut: stop the engine! Don't try to pull the chain saw free. If you do you may be injured by the chain when the chain saw suddenly breaks free. Use a lever to open up the cut and free the chain saw.**

The following instructions describe how to handle the commonest situations you are likely to encounter when using a chain saw.



# WORKING TECHNIQUES

## Limbing

When limbing thick branches you should use the same approach as for cutting.

Cut difficult branches piece by piece.

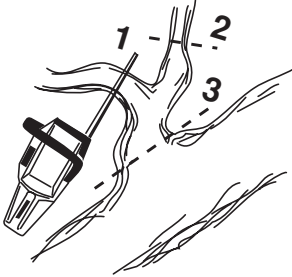

## Cutting



**WARNING! Never attempt to cut logs while they are in a pile or when a couple of logs are lying together. Such procedures drastically increase the risk of kickback which can result in a serious or fatal injury.**

If you have a pile of logs, each log you attempt to cut should be removed from the pile, placed on a saw horse or runners and cut individually.

Remove the cut pieces from the cutting area. By leaving them in the cutting area, you increase the risk for inadvertently getting a kickback, as well as increasing the risk of losing your balance while working.

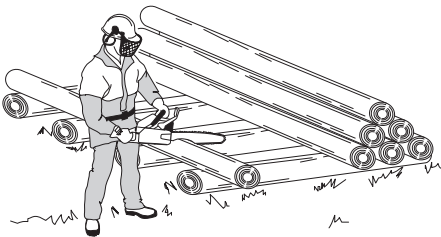
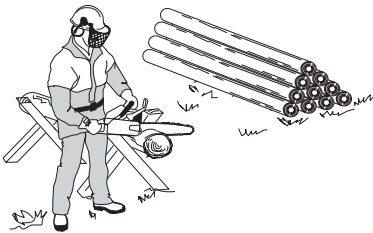

**The log is lying on the ground.** There is little risk of the chain jamming or the object splitting. However there is a risk that the chain will touch the ground when you finish the cut.



Cut all the way through the log from above. Avoid letting the chain touch the ground as you finish the cut. Maintain full throttle but be prepared for what might happen.

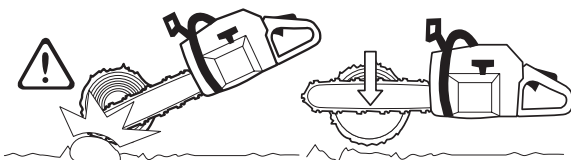

If it is possible (can you turn the log?) stop cutting about 2/3 of the way through the log.

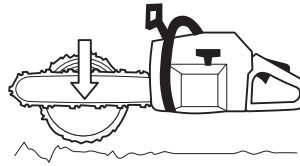

Turn the log and finish the cut from the opposite side.

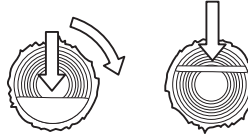

**The log is supported at one end.** There is a high risk that it will split.

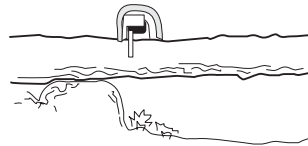

Start by cutting from below (about 1/3 of the way through).

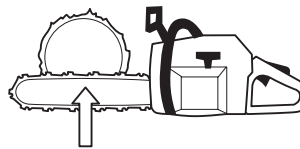

Finish by cutting from above so that the two cuts meet.

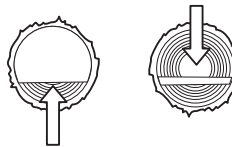

**The log is supported at both ends.** There is a high risk that the chain will jam.

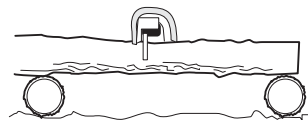

Start by cutting from above (about 1/3 of the way through).

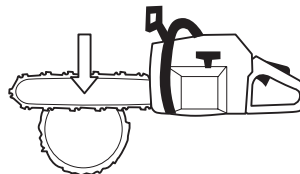

Finish by cutting from below so that the two cuts meet.

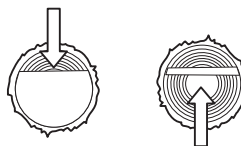

# WORKING TECHNIQUES

## Tree felling technique

**IMPORTANT!** It takes a lot of experience to fell a tree. Inexperienced users of chain saws should not fell trees. Do not attempt any task that you feel unsure of!

### Safe distance

The safe distance between a tree that is to be felled and anyone else working nearby is at least 2 1/2 tree lengths. Make sure that no-one else is in this "risk zone" before or during felling.

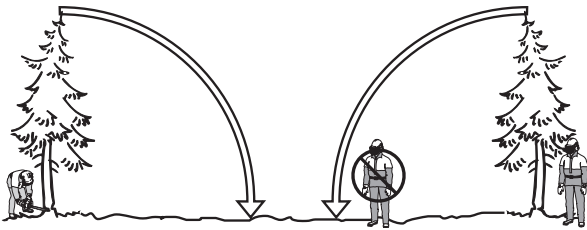

### Felling direction

The aim is to fell the tree in a position where you can limb and cross-cut the log as easily as possible. You want it to fall in a location where you can stand and move about safely.

Once you have decided which way you want the tree to fall you must judge which way the tree would fall naturally.

Several factors affect this:

- Lean of the tree
- Bend
- Wind direction
- Arrangement of branches
- Weight of snow
- Obstacles within the reach of the tree: for example, other trees, power lines, roads and buildings.
- Look for signs of damage and rot in the stem, this makes it more probably that the tree will break and start to fall before you expect it to.

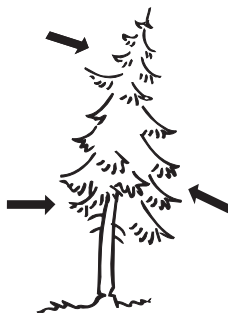

You may find you are forced to let the tree fall in its natural direction because it is impossible or dangerous to try to make it fall in the direction you first intended.

Another very important factor, which does not affect the felling direction but does affect your safety, is to make sure the tree has no damaged or dead branches that might break off and hit you during felling.

The main point to avoid is letting the tree fall onto another tree. It is very dangerous to remove a trapped tree and there is high accident risk. See instructions under the heading Freeing a tree that has fallen badly.



**IMPORTANT!** During critical felling operations, hearing protectors should be lifted immediately when sawing is completed so that sounds and warning signals can be heard.

### Clearing the trunk and preparing your retreat

Delimb the stem up to shoulder height. It is safer to work from the top down and to have the tree between you and the saw.



Remove any undergrowth from the base of the tree and check the area for obstacles (stones, branches, holes, etc.) so that you have a clear path of retreat when the tree starts to fall. Your path of retreat should be roughly 135 degrees away from the intended felling direction.

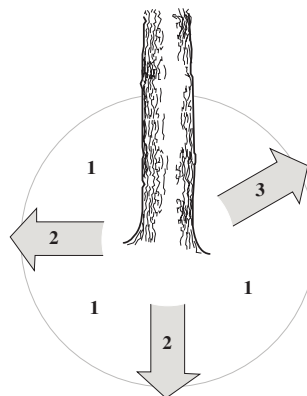

- 1 Danger zone
- 2 Retreat path
- 3 Felling direction



# WORKING TECHNIQUES

## Felling



**WARNING! Unless you have special training we advise you not to fell trees with a diameter larger than the bar length of your saw!**

Felling is done using three cuts. First you make the directional cuts, which consist of the top cut and the bottom cut, then you finish with the felling cut. By placing these cuts correctly you can control the felling direction very accurately.

### Directional cuts

To make the directional cuts you begin with the top cut. Stand to the right of the tree and cut on the pull stroke.

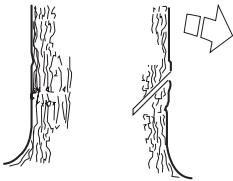

Next make the bottom cut so that it finishes exactly at the end of the top cut.



The directional cuts should run 1/4 of the diameter through the trunk and the angle between the top cut and bottom cut should be 45°.

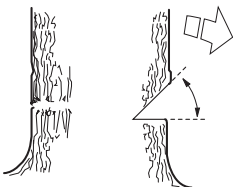

The line where the two cuts meet is called the directional cut line. This line should be perfectly horizontal and at right angles (90°) to the chosen felling direction.

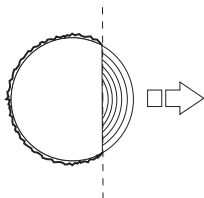

### Felling cut

The felling cut is made from the opposite side of the tree and it must be perfectly horizontal. Stand on the left side of the tree and cut on the pull stroke.

Make the felling cut about 3-5 cm (1.5-2 inches) above the bottom directional cut.

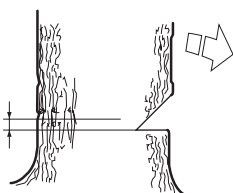

Set the spike bumper (if one is fitted) just behind the felling hinge. Use full throttle and advance the chain/bar slowly into the tree. Make sure the tree does not start to move in the opposite direction to your intended felling direction. Drive a wedge or breaking bar into the cut as soon as it is deep enough.

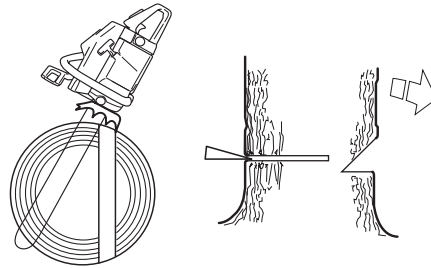

Finish the felling cut parallel with the directional cut line so that the distance between them is at least 1/10 of the trunk diameter. The uncut section of the trunk is called the felling hinge.

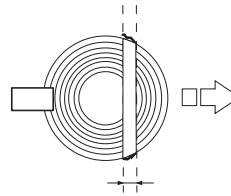

The felling hinge controls the direction that the tree falls in.

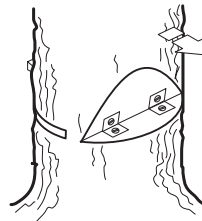

All control over the felling direction is lost if the felling hinge is too narrow or non-existent, or if the directional cuts and felling cut are badly placed.



When the felling cut and directional cut are complete the tree should start to fall by itself or with the aid of a felling wedge or breaking bar.

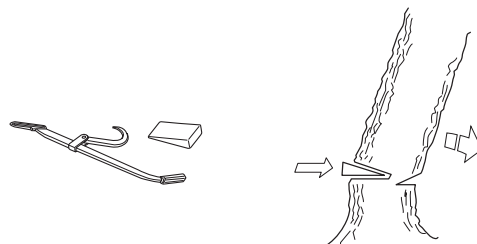

# WORKING TECHNIQUES

We recommend that you use a bar that is longer than the diameter of the tree, so that you can make the felling cut and directional cuts with single cutting strokes. See instructions under the heading Technical data section to find out which lengths of bar are recommended for your saw.

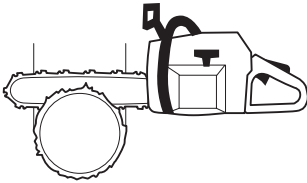

There are methods for felling trees with a diameter larger than the bar length. However these methods involve a much greater risk that the kickback zone of the bar will come into contact with the tree.

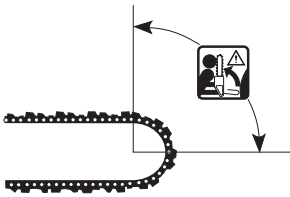

## Freeing a tree that has fallen badly

### Freeing a "trapped tree"

It is very dangerous to remove a trapped tree and there is high accident risk.

Never try to fell the tree that is trapped.

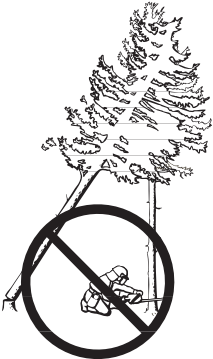

Never work in the risk zone of the hanging trapped tree.



The safest method is to use a winch.

- Tractor-mounted



- Portable

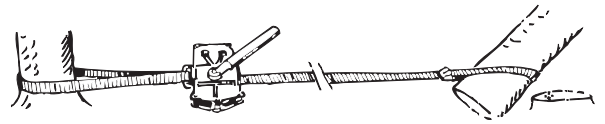

## Cutting trees and branches that are in tension

Preparations: Work out which side is in tension and where the point of maximum tension is (i.e. where it would break if it was bent even more).



Decide which is the safest way to release the tension and whether you are able to do it safely. In complicated situations the only safe method is to put aside your chain saw and use a winch.

### General advice:

Position yourself so that you will be clear of the tree or branch when the tension is released.



Make one or more cuts at or near the point of maximum tension. Make as many cuts of sufficient depth as necessary to reduce the tension and make the tree or branch break at the point of maximum tension.

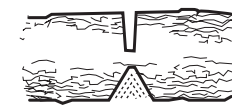

### Never cut straight through a tree or branch that is in tension!

If you must cut across tree/limb, make two to three cuts, one inch apart, one to two inches deep.



Continue to cut deeper until tree/limb bends and tension is released.



Cut tree/limb from outside the bend, after tension has been released.

# WORKING TECHNIQUES

## How to avoid kickback



**WARNING!** Kickback can happen very suddenly and violently; kicking the chain saw, bar and chain back at the user. If this happens when the chain is moving it can cause very serious, even fatal injuries. It is vital you understand what causes kickback and that you can avoid it by taking care and using the right working technique.

### What is kickback?

The word kickback is used to describe the sudden reaction that causes the chain saw and bar to jump off an object when the upper quadrant of the tip of the bar, known as the kickback zone, touches an object.



Kickback always occurs in the cutting plane of the bar. Normally the chain saw and bar are thrown backwards and upwards towards the user. However, the chain saw may move in a different direction depending on the way it was being used when the kickback zone of the bar touched the object.



Kickback only occurs if the kickback zone of the bar touches an object.

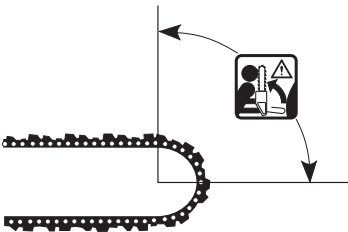

## Limbing



**WARNING!** A majority of kickback accidents occur during limbing. Do not use the kickback zone of the guide bar. Be extremely cautious and avoid contacting the log, other limbs or objects with the nose of the guide bar. Be extremely cautious of limbs under tension. They can spring back toward you and cause loss of control resulting in injury.

Make sure that you can stand and move about safely. Work on the left side of the trunk. Work as close as possible to the chain saw for maximum control. If possible, let the weight of the chain saw rest on the trunk.



Keep the trunk between you and the chain saw as you move along the trunk.

### Cutting the trunk into logs

See instructions under the heading Basic cutting technique.

# MAINTENANCE

## Carburettor

### Function, Basic settings, Fine adjustment



**WARNING!** Do not start the chain saw unless the bar, chain and clutch cover (chain brake) are fitted, otherwise the clutch may come loose and cause personal injury.

### Function

- The carburettor governs the engine's speed via the throttle control. Air and fuel are mixed in the carburettor. The air/fuel mixture is adjustable. Correct adjustment is essential to get the best performance from the machine.
- Adjusting the carburettor means that the engine is adapted to local operating conditions, e.g. climate, altitude, petrol and the type of 2-stroke oil.
- The carburettor has three adjustment controls:
  - L = Low speed jet
  - H = High speed jet
  - T = Idle adjustment screw

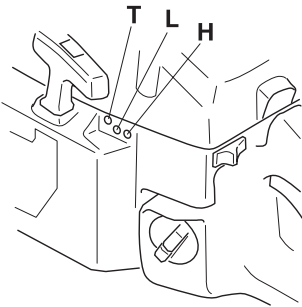

- The L and H-jets are used to adjust the supply of fuel to match the rate that air is admitted, which is controlled with the throttle. If they are screwed clockwise the air/fuel ratio becomes leaner (less fuel) and if they are turned anti-clockwise the ratio becomes richer (more fuel). A lean mixture gives a higher engine speed and a rich mixture gives a lower engine speed.
- The T-screw regulates the throttle setting at idle speed. If the T-screw is turned clockwise this gives a higher idle speed; turning it anti-clockwise gives a lower idle speed.

### Basic settings and running in

The basic carburettor settings are adjusted during testing at the factory. **The basic settings are H = 1 turn and L = 1 turn.**

To provide the engine's components with good initial lubrication (during running in) the carburettor should be set for a richer fuel mixture for the first 3-4 hours that the chain saw is in use. To do this, adjust the fast idle speed to 600-700 rpm below the recommended maximum fast idle speed.

If you are unable to check the fast idle speed using a tachometer the H-jet should not be set for a leaner mixture than given in the basic settings. The recommended maximum fast idle speed must not be exceeded.

**CAUTION!** If the chain rotates while idling the T-screw must be turned anti-clockwise until the chain stops.

### Fine adjustment

When the machine has been "run-in" the carburettor should be finely adjusted. The fine adjustment should be carried out by a qualified person. First adjust the L-jet, then the idling screw T and then the H-jet. **The recommended engine speeds are as follows:**

Max. fast idle speed, rpm	Idle speed, rpm
12500	2500

### Changing the type of fuel

Fine tuning may be required if the chain saw, after changing the type of fuel, performs differently with regard to starting, acceleration, maximum speed, etc.

### Conditions

- Before any adjustments are made the air filter should be clean and the cylinder cover fitted. Adjusting the carburettor while a dirty air filter is in use will result in a leaner mixture next time the filter is cleaned. This can give rise to serious engine damage.
- Carefully turn the L and H-jets clockwise as far as they will go. Now turn the jets one turn anti-clockwise. The carburettor is now set to H = 1 and L = 1.
- Now start the machine according to the starting instructions and let it warm up for 10 minutes.

**CAUTION!** If the chain rotates while idling the T-screw must be turned anti-clockwise until the chain stops.

- Place the machine on a flat surface so that the bar points away from you and so that the bar and chain do not come into contact with the surface or other objects.

### Low speed jet L

Try to find the highest idle speed by turning the low speed jet L clockwise then anti-clockwise. When the highest speed has been found, turn the low speed jet L 1/4 turn anti-clockwise.

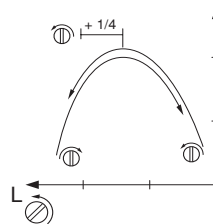

**CAUTION!** If the chain rotates while idling the T-screw must be turned anti-clockwise until the chain stops.

### Fine adjustment of the idle speed T

Adjust the idle speed with the T-screw. If it is necessary to re-adjust, turn the T-screw clockwise while the engine is running, until the chain starts to rotate. Then turn anti-clockwise until the chain stops. When the idle speed is correctly adjusted the engine should run smoothly in every position and the engine speed should be safely below the speed at which the chain starts to rotate.



**WARNING!** Contact your servicing dealer, if the idle speed setting cannot be adjusted so that the chain stops. Do not use the chain saw until it has been properly adjusted or repaired.

# MAINTENANCE

## High speed jet H

- The high speed jet H influences the power and engine speed of the machine. If the high speed jet is set too rich (H-jet screwed in too far) the machine will over-rev and this will damage the engine. Run the machine at full throttle for about 10 seconds. Then turn the H-jet 1/4 turn anti-clockwise. Run the machine at full throttle for another 10 seconds or so and listen to the difference in the fast idle speed. Repeat this procedure with the H-jet turned a further 1/4 turn anti-clockwise.

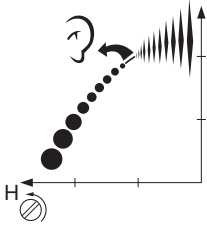

- You have now run the machine at settings of  $H = \pm 0$ ,  $H = +1/4$ ,  $H = +1/2$  relative to the basic settings. At full throttle the engine has sounded different for each setting. The H-jet is correctly adjusted when the machine burbles a little. If the machine "screams" then the machine is set too lean. If the muffler emits a lot of smoke and the machine burbles a lot then the setting is too rich. Turn the H-jet clockwise until the setting sounds right

**CAUTION!** For optimum adjustment of the carburettor, contact a qualified dealer/service workshop that has a revolution counter at their disposal. The recommended maximum fast idle speed must not be exceeded.

## Correctly adjusted carburettor

When the carburettor is correctly adjusted the machine accelerates without hesitation and burbles a little at full throttle. It is also important that the chain does not rotate at idle. If the L-jet is set too lean it may cause starting difficulties and poor acceleration. If the H-jet is set too lean the machine will have less power, poor acceleration and could suffer damage to the engine. If the L and H-jets are set too rich it will lead to acceleration problems or too low a working speed.

## Checking, maintaining and servicing chain saw safety equipment

Note! All service and repair work on the machine demands special training. This is especially true of the machine's safety equipment. If your machine fails any of the checks described below we recommend that you take it to your service workshop.

### Chain brake and front hand guard

#### Checking brake band wear

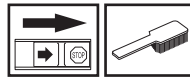

Brush off any wood dust, resin and dirt from the chain brake and clutch drum. Dirt and wear can impair operation of the brake.

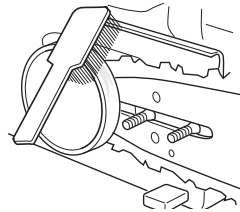

Regularly check that the brake band is at least 0.6 mm thick at its thinnest point.

#### Checking the front hand guard

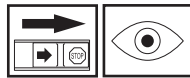

Make sure the front hand guard is not damaged and that there are no visible defects such as cracks.



Move the front hand guard forwards and back to make sure it moves freely and that it is securely anchored to the clutch cover.



# MAINTENANCE

## Checking the inertia brake release



Place the chain saw, with the engine switched off, on a stump or other stable surface. Release the front handle and let the saw fall by its own weight, rotating around the rear handle towards the stump.



When the bar hits the stump the brake should be applied.

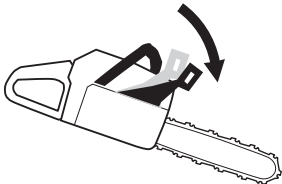

## Checking the brake trigger

Place the chain saw on firm ground and start it. Make sure the chain does not touch the ground or any other object. See the instructions under the heading Start and stop.

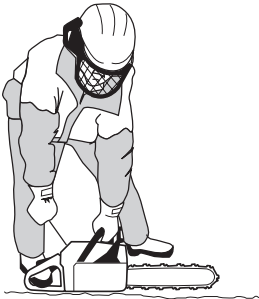

Grasp the chain saw firmly, wrapping your fingers and thumbs around the handles.

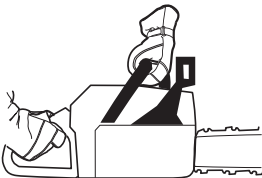

Apply full throttle and activate the chain brake by tilting your left wrist forward onto the front hand guard. Do not let go of the front handle. **The chain should stop immediately.**

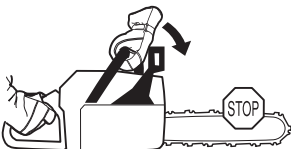

## Throttle lock



- Make sure the throttle control is locked at the idle setting when the throttle lock is released.

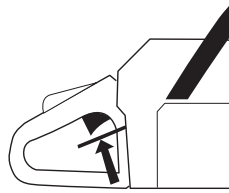

- Press the throttle lock and make sure it returns to its original position when you release it.

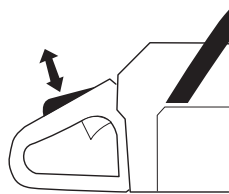

- Check that the throttle control and throttle lock move freely and that the return springs work properly.

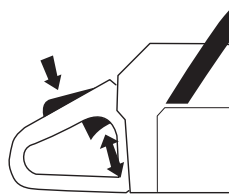

- Start the chain saw and apply full throttle. Release the throttle control and check that the chain stops and remains stationary. If the chain rotates when the throttle control is in the idle position you should check the carburettor idle adjustment.

## Chain catcher

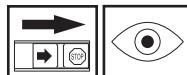

Check that the chain catcher is not damaged and is firmly attached to the body of the chain saw.

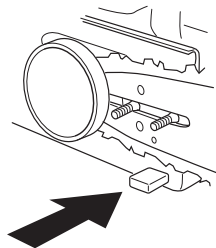



# MAINTENANCE

## Right hand guard

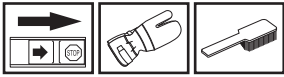

Check that the right hand guard is not damaged and that there are no visible defects, such as cracks.

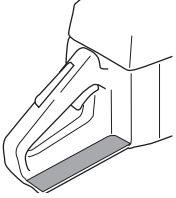

## Vibration damping system



Regularly check the vibration damping units for cracks or deformation.



Make sure the vibration damping units are securely attached to the engine unit and handle unit.

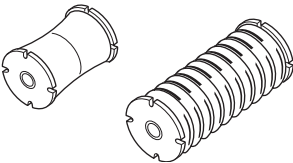

## Stop switch



Start the engine and make sure the engine stops when you move the stop switch to the stop setting.

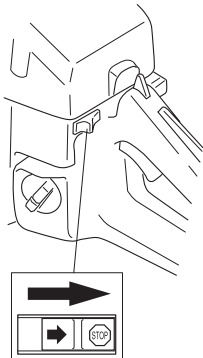

## Muffler

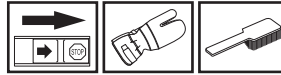

Never use a machine that has a faulty muffler.



Regularly check that the muffler is securely attached to the machine.

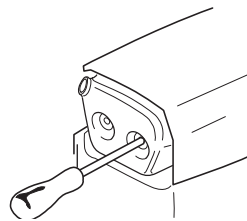

Some mufflers are equipped with a special spark arrestor mesh. If your machine has this type of muffler, you should clean the mesh at least once a week. This is best done with a wire brush. A blocked mesh will cause the engine to overheat and may lead to serious damage.

Note! The mesh must be replaced if it is damaged. If the mesh is blocked the machine will overheat and this will cause damage to the cylinder and piston. Never use a machine with a muffler that is in poor condition.

**Never use a muffler if the spark arrestor mesh is missing or defective.**

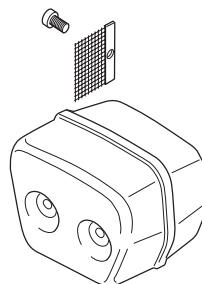

The muffler is designed to reduce the noise level and to direct the exhaust gases away from the operator. The exhaust gases are hot and can contain sparks, which may cause fire if directed against dry and combustible material.

A muffler equipped with a catalytic converter significantly reduces the amount of hydrocarbons (HC), nitrogen oxides (NO) and aldehydes in the exhaust fumes. Carbon monoxide (CO), which is poisonous and odourless, is not however reduced! Consequently, never work in an enclosed or badly ventilated area. Good air circulation should always prevail when working in snowy hollows, ravines or in confined conditions.

# MAINTENANCE

## Starter



**WARNING!** When the recoil spring is wound up in the starter housing it is under tension and can, if handled carelessly, pop out and cause personal injury.

Care must be exercised when replacing the return spring or the starter cord. Wear protective glasses and protective gloves.

## Changing a broken or worn starter cord



- Loosen the screws that hold the starter against the crankcase and remove the starter.

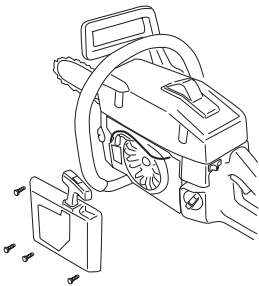

- Pull out the cord approx. 30 cm and hook it into the notch in the rim of the pulley. Release the recoil spring by letting the pulley rotate slowly backwards.

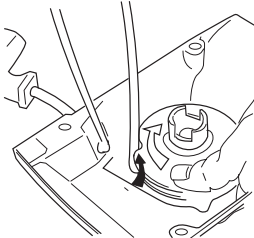

- Undo the screw in the centre of the pulley and remove the pulley. Insert and fasten a new starter cord to the pulley. Wind approx. 3 turns of the starter cord onto the pulley. Connect the pulley to the recoil spring so that the end of the spring engages in the pulley. Fit the screw in the centre of the pulley. Insert the starter cord through the hole in the starter housing and the starter handle. Make a secure knot in the end of the starter cord.

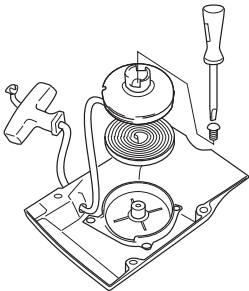

## Tensioning the recoil spring

- Hook the starter cord in the notch in the pulley and turn the starter pulley about 2 turns clockwise.

Note! Check that the pulley can be turned at least a further 1/2 turn when the starter cord is pulled all the way out.

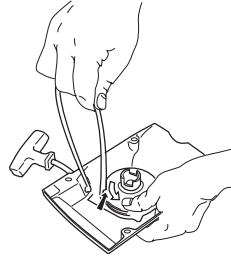

## Changing a broken recoil spring



- Lift up the starter pulley. See instructions under the heading Changing a broken or worn starter cord. Remember that the recoil spring is coiled under tension in the starter housing.

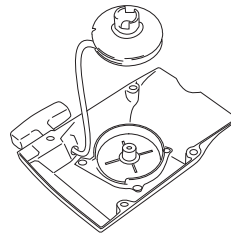

- The recoil spring is disassembled from the starter device, with its inside facing down. Tap the starter lightly against a working bench or similar. If the spring pops out when assembling, it should be mounted again, out and in towards the centre.

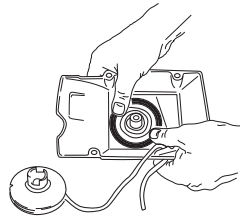

- Lubricate the recoil spring with light oil. Fit the cassette with recoil spring in the starter. Fit the starter pulley and tension the recoil spring.

## Fitting the starter

- To fit the starter, first pull out the starter cord and place the starter in position against the crankcase. Then slowly release the starter cord so that the pulley engages with the pawls.
- Fit and tighten the screws that hold the starter.

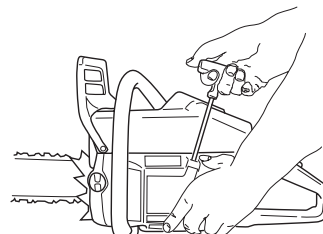



# MAINTENANCE

## Air filter

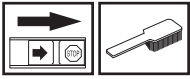

The air filter must be regularly cleaned to remove dust and dirt in order to avoid:

- Carburettor malfunctions
- Starting problems
- Loss of engine power
- Unnecessary wear to engine parts.
- Excessive fuel consumption.
- Remove the air filter after taking off the air filter cover. When refitting make sure that the air filter seals tightly against the filter holder. Clean the filter by brushing or shaking it.

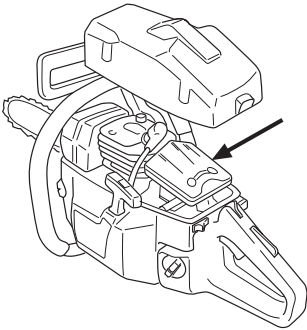

The filter can be cleaned more thoroughly by washing it in water and detergent.

An air filter that has been in use for a long time cannot be cleaned completely. The filter must therefore be replaced with a new one at regular intervals. **A damaged air filter must always be replaced.**

A HUSQVARNA chain saw can be equipped with different types of air filter according to working conditions, weather, season, etc. Contact your dealer for advice.

## Spark plug



The spark plug condition is influenced by:

- Incorrect carburettor adjustment.
- An incorrect fuel mixture (too much or incorrect type of oil).
- A dirty air filter.

These factors cause deposits on the spark plug electrodes, which may result in operating problems and starting difficulties.

If the machine is low on power, difficult to start or runs poorly at idle speed: always check the spark plug first before taking any further action. If the spark plug is dirty, clean it and check

that the electrode gap is 0.5 mm. The spark plug should be replaced after about a month in operation or earlier if necessary.

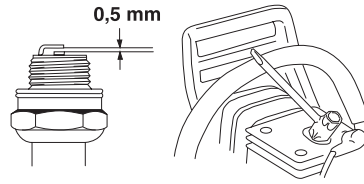

Note! Always use the recommended spark plug type! Use of the wrong spark plug can damage the piston/cylinder. Check that the spark plug is fitted with a suppressor.

## Lubricating the bar tip sprocket

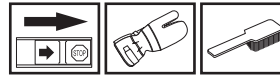

Lubricate the bar tip sprocket each time you refuel. Use the special grease gun and a good quality bearing grease.

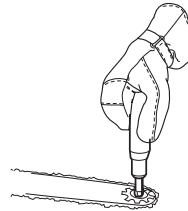

## Needle bearing lubrication



The clutch drum has a needle bearing on the output shaft. This needle bearing must be lubricated regularly (once a week).

When lubricating, remove the clutch cover by loosening the two bar nuts. Lay the saw on its side with the clutch drum upwards.

Lubrication involves grease being squirted into the centre of the crankshaft using a grease gun.

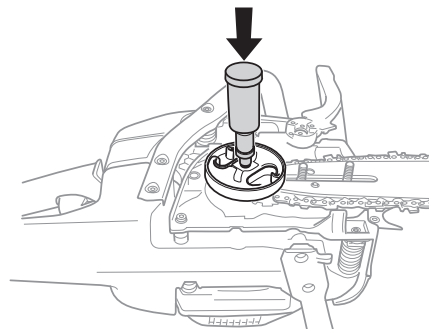

# MAINTENANCE

## Adjustment of the oil pump



The oil pump can be adjusted to give four different oil flow rates. To adjust the flow rate, first remove the chain, bar, clutch cover, centrifugal clutch, and the clutch drum. Using a screwdriver, adjust the oil flow rate by turning the adjuster screw one way or the other. The projection on the screw should point towards the chosen setting. The diagram shows the setting for flow rate 2.

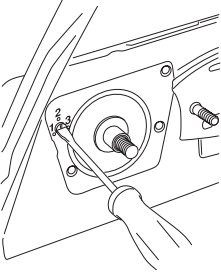

Recommended settings:  
Bar 18"-20": Position 2  
Bar 20"- : Position 3-4



**WARNING! The engine must not be running when making adjustments.**

## Cooling system

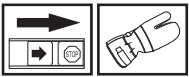

To keep the working temperature as low as possible the machine is equipped with a cooling system.

The cooling system consists of:

- 1 Air intake on the starter.
- 2 Air guide plate.
- 3 Fins on the flywheel.
- 4 Cooling fins on the cylinder.
- 5 Cylinder cover (directs cold air over the cylinder).

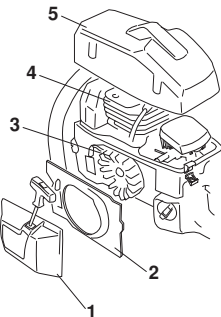

Clean the cooling system with a brush once a week, more often in demanding conditions. A dirty or blocked cooling system results in the machine overheating which causes damage to the piston and cylinder.

Note! The cooling system on a chain saw with catalytic converter must be cleaned daily. This is particularly important on chain saws with catalytic converters, because the higher exhaust temperature requires efficient cooling of the engine and the catalytic converter unit.

## Winter use

Running problems can occur when using the machine in the cold and snowy conditions caused by:

- Too low engine temperature.
- Icing of the air filter and carburettor.

Special measures are therefore often required:

- Partly mask the air inlet on the starter to increase the working temperature of the engine.
- Preheat the intake air to the carburettor by using the heat from the cylinder.

### Temperature 0°C or colder:



The cylinder cover is designed so it can be adjusted for running in cold weather. Twist the winter flap so that preheated air from the cylinder can pass into the carburettor space preventing icing of the air filter, etc.

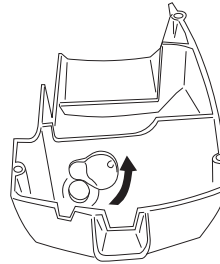

### Temperature -5°C or colder:



When using the saw in cold weather or powder snow conditions you should cover the starter unit with adhesive tape. This reduces the flow of cold air and prevents large amounts of snow from being sucked in.

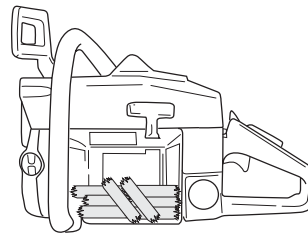

**IMPORTANT! If the temperature rises above -5°C or 0°C respectively the machine MUST be restored to its normal set-up. Otherwise there is a risk of overheating, which can cause severe engine damage.**

**IMPORTANT! Any maintenance other than that described in this manual must be carried out by your servicing dealer (retailer).**

# MAINTENANCE

## Maintenance schedule

The following is a list of the maintenance that must be performed on the machine. Most of the items are described in the Maintenance section.

Daily maintenance	Weekly maintenance	Monthly maintenance
Clean the outside of the machine.	On chain saws without a catalytic converter, check the cooling system weekly.	Check the brake band on the chain brake for wear. Replace when less than 0.6 mm (0,024 inch) remains at the most worn point.
Check that the components of the throttle control work safely. (Throttle lock and throttle control.)	Check the starter, starter cord and return spring.	Check the clutch centre, clutch drum and clutch spring for wear.
Clean the chain brake and check that it operates safely. Make sure that the chain catcher is undamaged, and replace it if necessary.	Check that the vibration damping elements are not damaged.	Clean the spark plug. Check that the electrode gap is 0.5 mm.
The bar should be turned daily for more even wear. Check the lubrication hole in the bar, to be sure it is not clogged. Clean the bar groove. If the bar has a sprocket tip, this should be lubricated.	Lubricate the clutch drum bearing.	Clean the outside of the carburettor.
Check that the bar and chain are getting sufficient oil.	File off any burrs from the edges of the bar.	Check the fuel filter and the fuel hose. Replace if necessary.
Check the saw chain with regard to visible cracks in the rivets and links, whether the saw chain is stiff or whether the rivets and links are abnormally worn. Replace if necessary.	Clean or replace the spark arrestor mesh on the muffler.	Empty the fuel tank and clean the inside.
Sharpen the chain and check its tension and condition. Check the drive sprocket for excessive wear and replace if necessary.	Clean the carburettor compartment.	Empty the oil tank and clean the inside.
Clean the starter units air intake.	Clean the air filter. Replace if necessary.	Check all cables and connections.
Check that nuts and screws are tight.		
Check that the stop switch works correctly.		
Check that there are no fuel leaks from the engine, tank or fuel lines.		
On chain saws with a catalytic converter, check the cooling system daily.		

---

# TECHNICAL DATA

---

## Technical data

	281XP	288XP
<b>Engine</b>		
Cylinder displacement, cm <sup>3</sup>	80,7	87
Cylinder bore, mm	52	54
Stroke, mm	38,0	38,0
Idle speed, rpm	2500	2500
Power, kW/ rpm	4,2/9000	4,5/9300
<b>Ignition system</b>		
Manufacturer of ignition system	SEM	SEM
Type of ignition system	AM 7	AM 7
Spark plug	Champion RCJ 7Y	Champion RCJ 7Y
Electrode gap, mm	0,5	0,5
<b>Fuel and lubrication system</b>		
Manufacturer of carburettor	Tillotson	Tillotson
Carburettor type	HS 228	HS 228
Fuel tank capacity, litre	0,9	0,9
Oil pump capacity at 8,500 rpm, ml/min	9-12-15-18	9-12-15-18
Oil tank capacity, litre	0,5	0,5
Type of oil pump	Automatic	Automatic
<b>Weight</b>		
Chain saw without bar or chain, empty tanks, kg	7,6	7,6
<b>Noise emissions</b>		
(see note 1)		
Sound power level, measured dB(A)	116	117
Sound power level, guaranteed L <sub>WA</sub> dB(A)	117	117
<b>Sound levels</b>		
(see note 2)		
Equivalent sound pressure level at operator's ear, measured according to relevant international standards, dB(A)	106	106
<b>Vibration levels</b>		
(see note 3)		
Front handle, m/s <sup>2</sup>	6,2	6,2
Rear handle, m/s <sup>2</sup>	6,9	6,9
<b>Chain/bar</b>		
Standard bar length, inch/cm	18/46	18/46
Recommended bar lengths, inch/cm	15-28/38-71	15-28/38-71
Usable cutting length, inch/cm	13-27/34-68	13-27/34-68
Chain speed at max. power, m/sec	20,0	20,7
Pitch, inch/mm	3/8 /9,52	3/8 /9,52
Thickness of drive links, inch/mm	0,058/1,5	0,058/1,5
Number of teeth on drive sprocket	7	7

Note 1: Noise emissions in the environment measured as sound power (L<sub>WA</sub>) in conformity with EC directive 2000/14/EC.

Note 2: Equivalent sound pressure level, according to ISO 7182, is calculated as the time-weighted energy total for noise pressure levels under various working conditions with the following time distribution: 1/2 idling, 1/2 max. load.

Note 3: Equivalent vibration level, according to ISO 7505, is calculated as the time-weighted energy total for vibration levels under various working conditions with the following time distribution: 1/2 idling, 1/2 max. load.







# TECHNICAL DATA

## Bar and chain combinations

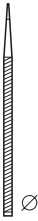
The following recommended combinations of bar and saw chain are type approved for your chain saw.

Bar				Chain	
Length, inch	Pitch, inch	Gauge, mm	Max. nose radius	Type	Drive link count
15	3/8	1,5	11T	Husqvarna H42	56
16	3/8	1,5	11T		60
18	3/8	1,5	11T		68
20	3/8	1,5	11T		72
24	3/8	1,5	11T		84
28	3/8	1,5	11T		92
18	3/8	1,5	34 mm		68
20	3/8	1,5	34 mm		72
24	3/8	1,5	34 mm		84
28	3/8	1,5	34 mm		92

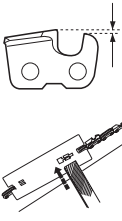
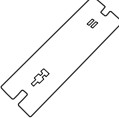
## Saw chain filing and file gauges

							
H42	inch/mm	60°	25°	10°	inch/mm	5056981-01	5056981-07

---

# TECHNICAL DATA

---

## EC-declaration of conformity

### (Applies to Europe only)

Electrolux do Brasil S.A. Div. Husqvarna, +55-16-3373 5262, declares under sole responsibility that the chain saws **Husqvarna 281XP/XPG and 288XP/XPG** from 2005's serial numbers and onwards (the year is clearly stated in plain text on the type plate with subsequent serial number), are in conformity with the requirements of the COUNCIL'S DIRECTIVES:

of June 22, 1998 "relating to machinery" **98/37/EC**, annex IIA.

of May 3, 1989 "relating to electromagnetic compatibility" **89/336/EEC**, and applicable supplements.

of May 8, 2000 "relating to the noise emissions in the environment" **2000/14/EC**.

For information relating to noise emissions, see the chapter Technical data. The following standards have been applied: **EN ISO 12100-2, CISPR 12:1997, EN ISO 11681-1; 2004.**

Notified body: **0404, SMP Svensk Maskinprovning AB, Fyrisborgsgatan 3, SE-754 50 Uppsala, Sweden**, has carried out EC type examination in accordance with the machinery directive's (98/37/EC) article 8, point 2c. The certificates for EC type examination in accordance with annex VI, have the numbers: **404/04/1046** - 281XP/XPG, 288XP/XPG.

In addition, SMP, Svensk Maskinprovning AB, Fyrisborgsgatan 3, SE-754 50 Uppsala, Sweden, has certified conformity with annex V of the Council's Directive of May 8, 2000 "relating to the noise emissions in the environment" 2000/14/EC. The certificates have the numbers: **01/161/010** - 281XP/XPG, **01/161/011** - 288XP/XPG.

The supplied chain saw conforms to the example that underwent EC type examination.

Husqvarna December 30, 2004



Bo Andréasson, Managing Director





1150043-26



2005-07-22