



SPARE PARTS LIST

LAWN MOWERS: CONSUMER
WALK-BEHINDS

LC48 VE, 96697540400, 2011-01

D LC48VE
Collect parts

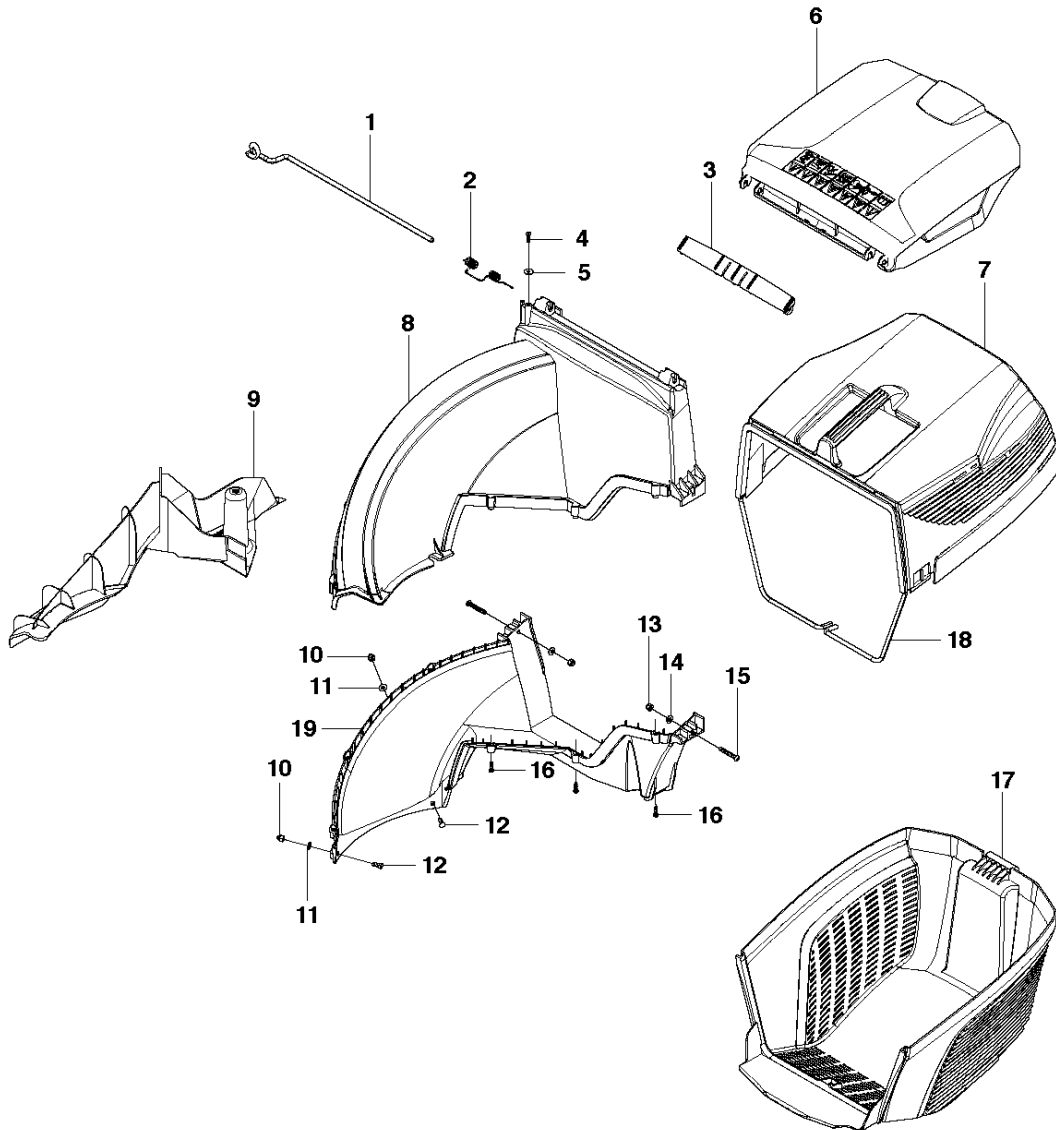

Ref	Part No	Description	Remark	QTY KIT
1	502 24 59-01	AXLE		1
2	502 24 47-01	SPRING		1
3	504 59 81-01	COVER LID		1
4	502 43 53-01	SCREW ITXPANT		1
5	505 19 84-01	WASHER		1
6	501 96 77-01	HATCH		1
7	501 98 77-01	GRASSBAG		1
8	501 96 75-01	CHUTE		1
9	504 13 71-01	MULCH PLUG		1
10	502 30 50-01	CAP NUT		2
11	505 19 84-01	WASHER		2
12	505 15 61-01	SCREW		2
13	522 66 93-02	LOCKING NUT		2
14	531 20 66-66	WASHER		2
15	505 55 77-01	SCREW ITXPANTT		2
16	502 43 53-01	SCREW ITXPANT		7
17	501 98 76-01	GRASSBAG		1
18	502 44 71-01	GRASSBAG		1
19	501 96 73-01	CHUTE		1

C LC48VE
Engine

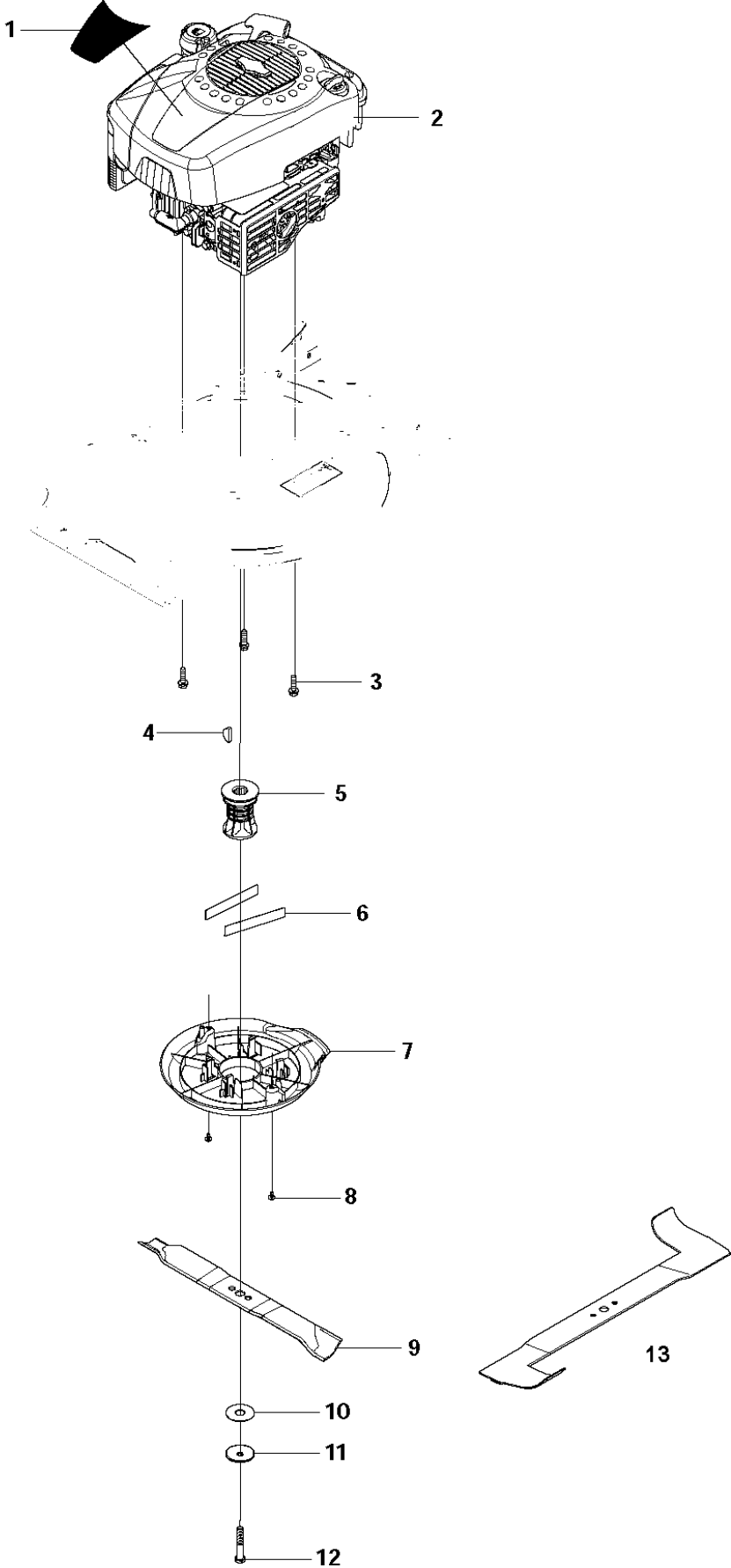

ENGINE

LC48 VE, 96697540400, 2011-01

Ref	Part No	Description	Remark	QTY KIT
1	521 88 89-01	LABEL		1
2	126T07-0262-B1	TBD	Briggs & Stratton	1
3	531 21 28-51	SCREW		3
4	531 20 49-07	KEY		1
5	531 20 78-48	SUPPORT		1
6	504 62 42-01	WEAR PLATE		2
7	501 96 81-01	BELT COVER		1
8	505 52 46-01	SCREW ITXPANTT		2
9	505 52 41-01	MOWER BLADE		1
10	531 20 72-43	WASHER		1
11	531 20 72-37	WASHER		1
12	531 20 66-49	SCREW		1
13	510 43 66-01	BLADE		1

B LC48VE
Handle

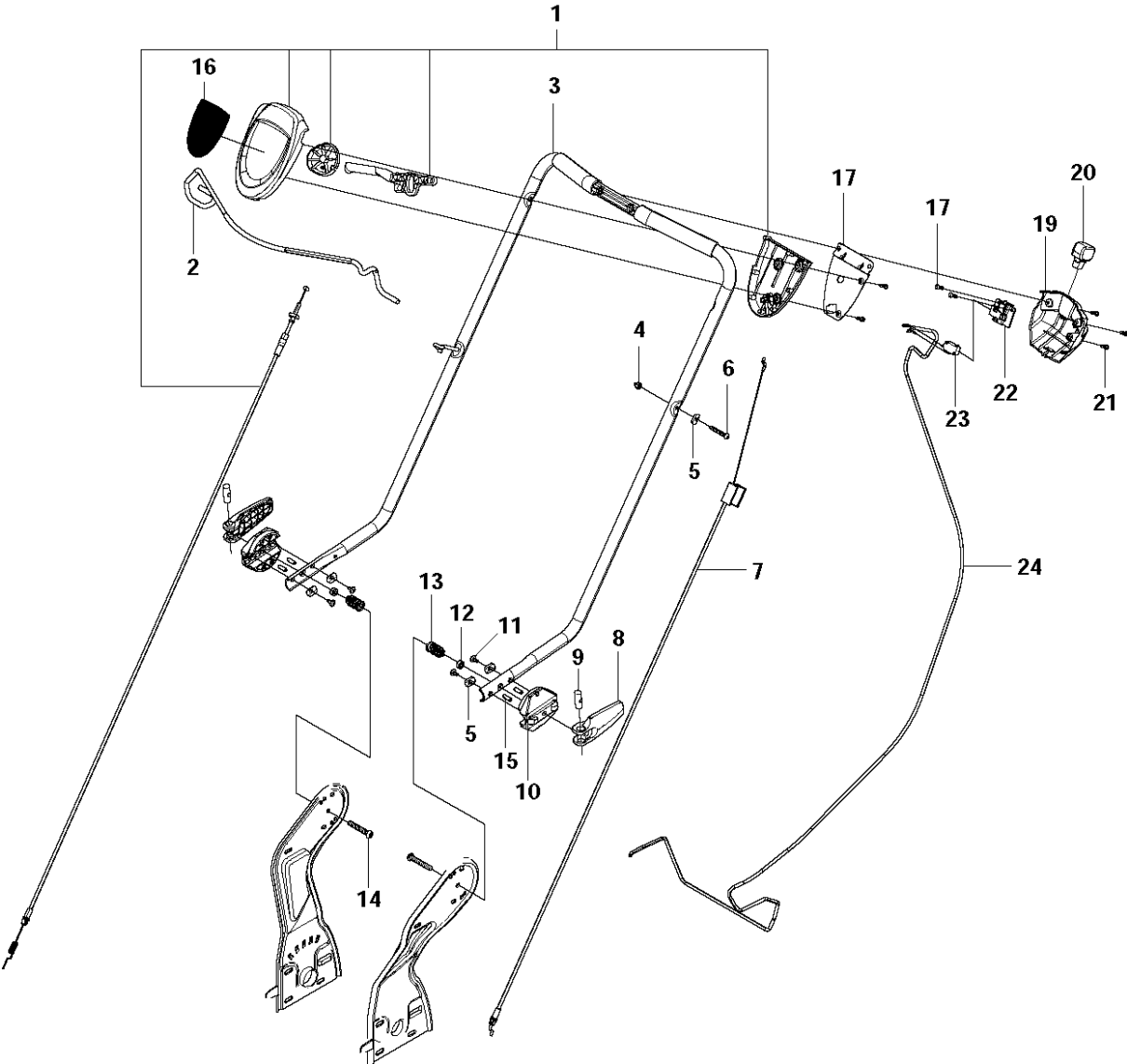

HANDLE

LC48 VE, 96697540400, 2011-01

Ref	Part No	Description	Remark	QTY KIT
1	544 93 29-05	CONTROL		1
2	502 28 93-01	BAIL ARM		1
3	522 74 84-01	HANDLE ASSY		1
4	502 30 50-01	CAP NUT		1
5	531 20 49-61	WASHER		1
6	505 55 77-02	SCREW ITXPANTT		1
7	522 93 74-01	CABLE		1
8	504 13 83-01	LEVER		2
9	505 53 11-01	PIN		2
10	504 13 89-01	ADJUSTING DISC		2
11	502 43 52-03	SCREW ITXPANTT		4
12	522 91 94-01	LOCKING NUT		2
13	504 63 81-01	SPRING		2
14	505 52 46-01	SCREW ITXPANTT		2
15	505 50 81-01	NEEDLE ROLLER		4
16	544 92 81-01	LABEL		1
17	532 18 70-97	BRACKET		1
18	502 43 53-01	SCREW ITXPANT		2
19	510 23 74-01	COVER		1
20	522 03 60-01	IGNITION KEY ASSY		1
21	574 39 14-01	SCREW ITXPANT		5
22	510 08 83-01	ELECTRIC START		1
23	525 48 63-01	MICRO SWITCH		1
24	515 99 62-01	ELECTRIC CABLE		1

A LC48VE
Deck

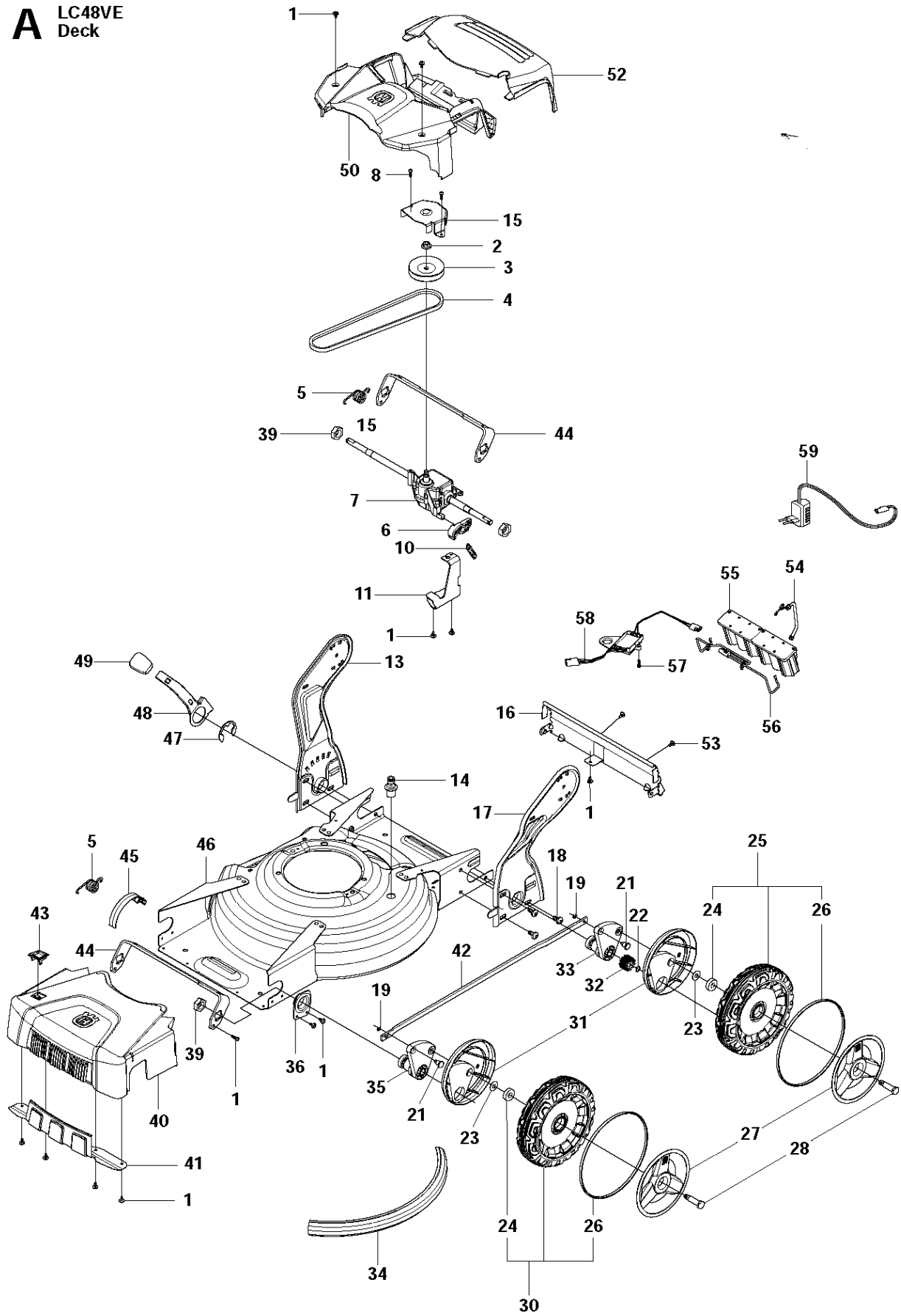

MOWER DECK / CUTTING DECK

LC48 VE, 96697540400, 2011-01

Ref	Part No	Description	Remark	QTY KIT
1	502 43 52-01	SCREW ITXPANTT		17
2	504 05 56-01	NUT FLANGE		1
3	504 05 33-01	PULLEY		1
4	501 98 66-01	BELT		1
5	522 02 46-01	SPRING		2
6	504 04 83-01	LEVER		1
7	504 04 80-01	GEAR BOX		1
8	502 43 53-01	SCREW ITXPANT		2
10	504 04 87-01	SPRING		1
11	504 04 86-01	BRACKET		1
13	504 00 00-01	HANDLE SUPPORT		1
14	531 20 58-48	CONNECTOR		1
15	522 61 23-01	BELT GUIDE		1
16	504 64 15-01	SKID PLATE		1
17	504 00 32-01	HANDLE SUPPORT		1
18	504 64 16-02	SCREW ITXPANTT		6
19	735 31 09-21	E-CLIP		2
21	504 62 50-01	SHAFT		2
22	504 70 28-01	LOCK RING		2
23	505 22 14-01	WASHER		4
24	738 21 01-04	BALL BEARING		8
25	544 91 69-02	WHEEL ASSY		2
26	544 43 28-01	O-RING		4
27	544 44 39-01	HUB CAP		4
28	544 45 34-01	SCREW		4
30	502 49 68-01	WHEEL ASSY		2
31	504 62 41-01	DUST COVER		4
32	544 34 23-01	PINION		2
33	504 70 98-01	LINK ARM ASSY		2
34	504 69 50-01	BUMPER		1
35	504 70 98-02	LINK ARM ASSY		2
36	504 62 49-01	BRACKET		2
39	505 52 10-01	NUT		4
40	502 62 44-01	FRONT COVER		1
41	502 62 54-01	SKID PLATE		1
42	504 61 55-01	ROD		1
43	504 62 75-01	INDEX WINDOW		1
44	504 61 46-01	TRANSVERSAL ROD		2
45	504 62 76-01	INDEX SCALE		1
46	501 37 55-01	CHASSIS		1
47	735 31 36-21	LOCK WASHER		1
48	504 83 82-01	LEVER		1
49	504 83 83-01	KNOB		1
50	505 10 94-01	REAR COVER		1
52	505 20 21-01	HATCH		1
53	502 43 52-01	SCREW ITXPANTT		2
54	522 47 09-01	HOLDER ASSY		1
55	515 99 63-01	BATTERY		1
56	522 00 00-01	WIRE ASSY		1
57	502 45 53-01	WASHER		1
58	522 02 80-01	START MODULE		1
59	502 95 12-01	BATTERY CHARGER		1
60	531 21 17-38	CHARGER		1